



Silicon N-Channel Power MOSFET



CS1404 A8

General Description:

CS1404 A8, the silicon N-channel Enhanced VDMOSFETs, is obtained by the self-aligned planar Technology which reduce the conduction loss, improve switching performance and enhance the avalanche energy. The transistor can be used in various power switching circuit for system miniaturization and higher efficiency. The package form is TO-220AB, which accords with the RoHS standard.

Features:

- I **Fast Switching**
- I **Low ON Resistance**($R_{dson} \leq 4.5m\Omega$)
- I **Low Gate Charge** (Typical Data:103.6nC)
- I **Low Reverse transfer capacitances**(Typical:170pF)
- I **100% Single Pulse avalanche energy Test**

Applications:

Power switch circuit of adaptor and charger.

Absolute ($T_c = 25^\circ\text{C}$ unless otherwise specified):

Symbol	Parameter	Rating	Units
V_{DSS}	Drain-to-Source Voltage	40	V
I_D	Continuous Drain Current	202	A
	Continuous Drain Current $T_c = 100^\circ\text{C}$	143	A
I_{DM}^{a1}	Pulsed Drain Current	808	A
V_{GS}	Gate-to-Source Voltage	± 20	V
E_{AS}^{a2}	Single Pulse Avalanche Energy	519	mJ
P_D	Power Dissipation	271	W
	Derating Factor above 25°C	2.16	W/ $^\circ\text{C}$
T_J, T_{stg}	Operating Junction and Storage Temperature Range	150, -55 to 150	$^\circ\text{C}$
T_L	Maximum Temperature for Soldering	300	$^\circ\text{C}$

V_{DSS}	40	V
I_D (Silicon limited current)	202	A
$P_D(T_c=25^\circ\text{C})$	271	W
$R_{DS(ON)Typ}$	3.5	m Ω

TO-220AB



1. Gate 2. Drain 3. Source

Inner Equivalent Principium Chart

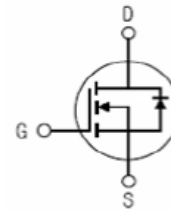

Electrical Characteristics (T_c= 25°C unless otherwise specified):

OFF Characteristics						
Symbol	Parameter	Test Conditions	Rating			Units
			Min.	Typ.	Max.	
V _{DSS}	Drain to Source Breakdown Voltage	V _{GS} =0V, I _D =250μA	40	--	--	V
I _{DSS}	Drain to Source Leakage Current	V _{DS} =40V, V _{GS} = 0V, T _a = 25°C	--	--	1	μA
		V _{DS} =32V, V _{GS} = 0V, T _a = 125°C	--	--	100	μA
I _{GSS(F)}	Gate to Source Forward Leakage	V _{GS} =+20V	--	--	100	nA
I _{GSS(R)}	Gate to Source Reverse Leakage	V _{GS} =-20V	--	--	-100	nA

ON Characteristics						
Symbol	Parameter	Test Conditions	Rating			Units
			Min.	Typ.	Max.	
R _{DS(ON)}	Drain-to-Source On-Resistance	V _{GS} =10V, I _D =81A	--	3.5	4.5	mΩ
V _{GS(TH)}	Gate Threshold Voltage	V _{DS} = V _{GS} , I _D = 250μA	2.0	--	4.0	V
Pulse width tp ≤ 300μs, δ ≤ 2%						

Dynamic Characteristics						
Symbol	Parameter	Test Conditions	Rating			Units
			Min.	Typ.	Max.	
C _{iss}	Input Capacitance	V _{GS} =0V, V _{DS} =25V f=1.0MHz	--	5431	--	pF
C _{oss}	Output Capacitance		--	1542	--	
C _{rss}	Reverse Transfer Capacitance		--	170	--	

Resistive Switching Characteristics						
Symbol	Parameter	Test Conditions	Rating			Units
			Min.	Typ.	Max.	
t _{d(ON)}	Turn-on Delay Time	V _{GS} =10V, R _G =2.5Ω V _{DD} =20V, I _D =81A	--	29.1	--	ns
t _r	Rise Time		--	27.5	--	
t _{d(OFF)}	Turn-Off Delay Time		--	85.3	--	
t _f	Fall Time		--	35.7	--	
Q _g	Total Gate Charge	V _{GS} =10V, V _{DD} =32V I _D =81A	--	103.6	--	nC
Q _{gs}	Gate to Source Charge		--	20	--	
Q _{gd}	Gate to Drain ("Miller") Charge		--	33.2	--	

Source-Drain Diode Characteristics						
Symbol	Parameter	Test Conditions	Rating			Units
			Min.	Typ.	Max.	
I_S	Continuous Source Current (Body Diode)		--	--	202	A
I_{SM}	Maximum Pulsed Current (Body Diode)		--	--	808	A
V_{SD}	Diode Forward Voltage	$I_S=95A, V_{GS}=0V$	--	--	1.5	V
t_{rr}	Reverse Recovery Time	$I_S=10A, T_j = 25^\circ C$ $dI_F/dt=100A/us,$ $V_{GS}=0V$	--	1708	--	ns
Q_{rr}	Reverse Recovery Charge		--	4.36	--	uC
I_{RRM}	Reverse Recovery Current		--	5.1	--	A
Pulse width $t_p \leq 300\mu s, \delta \leq 2\%$						

Symbol	Parameter	Max.	Units
$R_{\theta JC}$	Junction-to-Case	0.46	$^\circ C/W$
$R_{\theta JA}$	Junction-to-Ambient	62.5	$^\circ C/W$

^{a1}: Repetitive rating; pulse width limited by maximum junction temperature

^{a2}: $L=0.12mH, I_D=95A, Start T_j=25^\circ C$

Characteristics Curve:

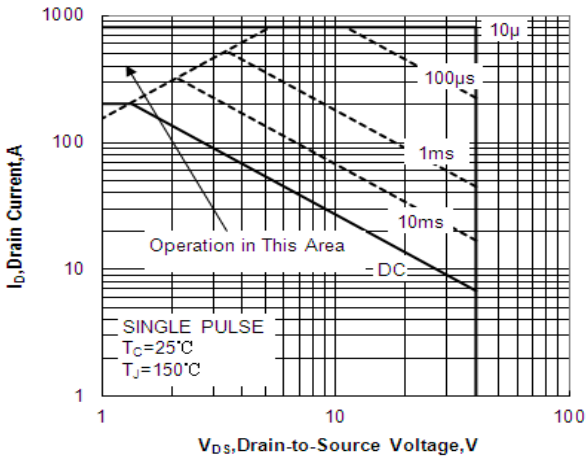

Figure 1 Maximum Forward Bias Safe Operating Area

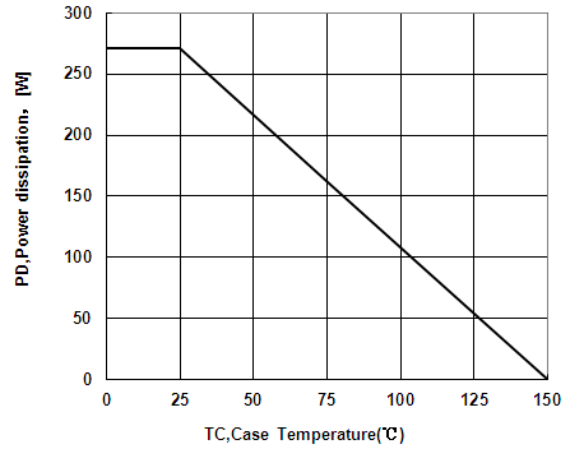

Figure 2 Maximum Power Dissipation vs Case Temperature

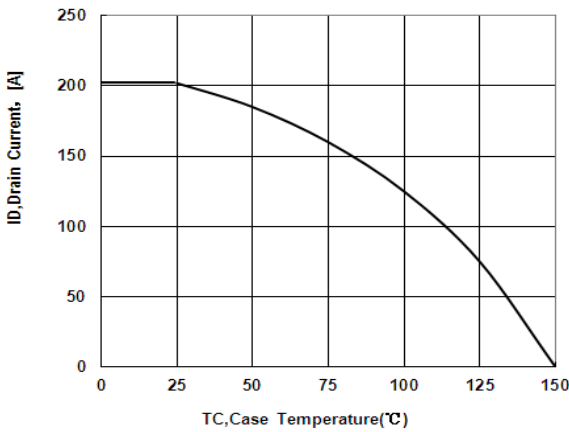

Figure 3 Maximum Continuous Drain Current vs Case Temperature

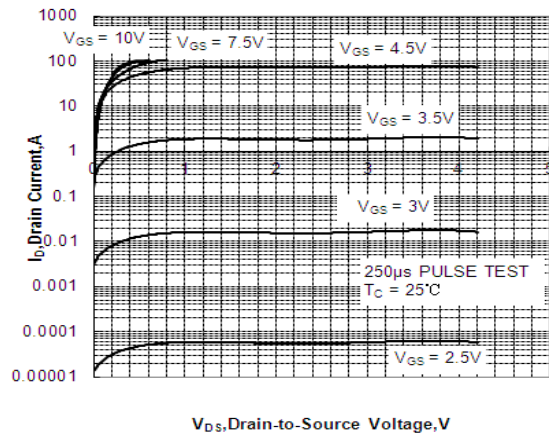

Figure 4 Typical Output Characteristics

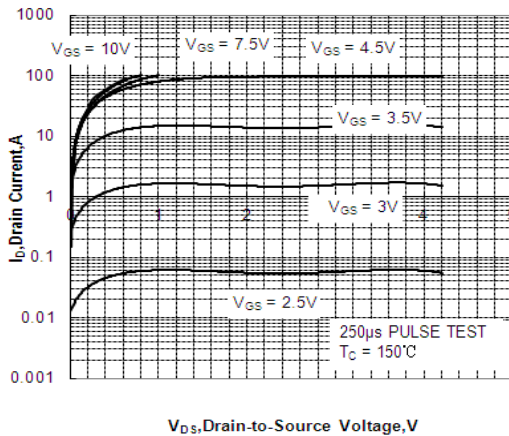

Figure 5 Typical Output Characteristics

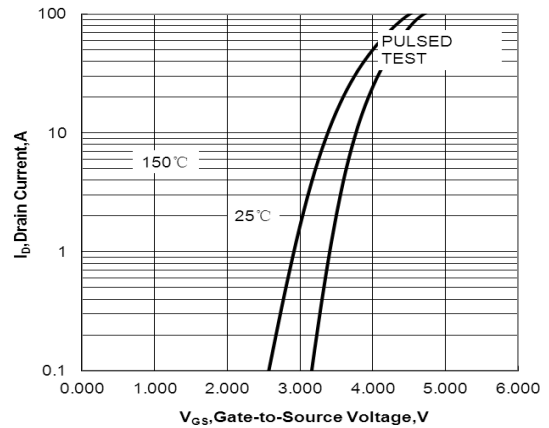

Figure 6 Typical Transfer Characteristics

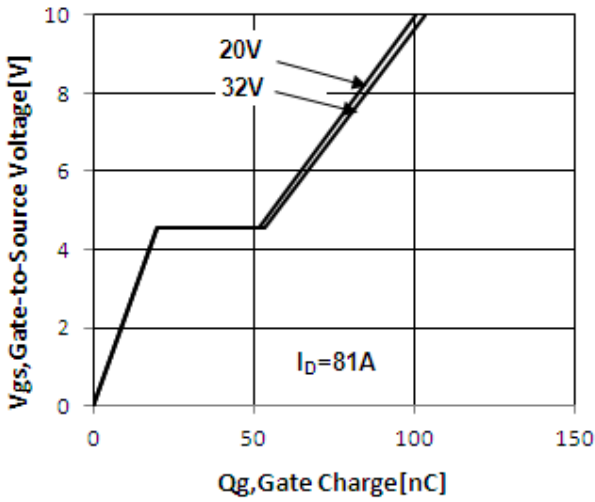

Figure 7 Typical Gate Charge vs Gate to Source Voltage

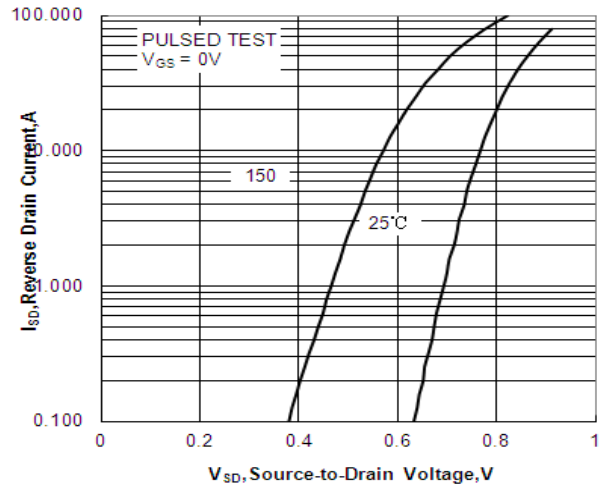

Figure 8 Typical Body Diode Transfer Characteristics

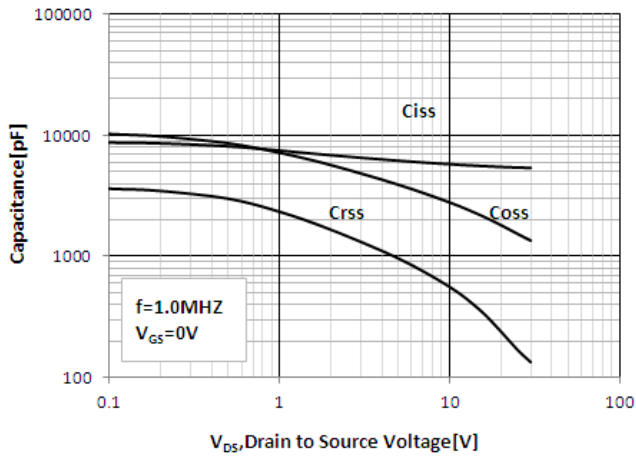

Figure 9 Typical Capacitance vs Drain to Source Voltage

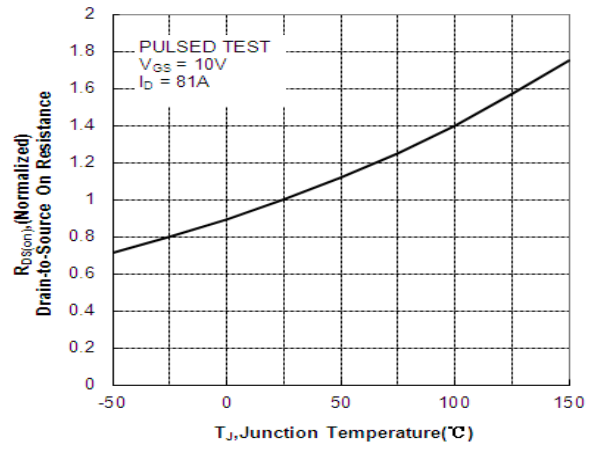

Figure 10 Typical Drain to Source on Resistance vs Junction Temperature

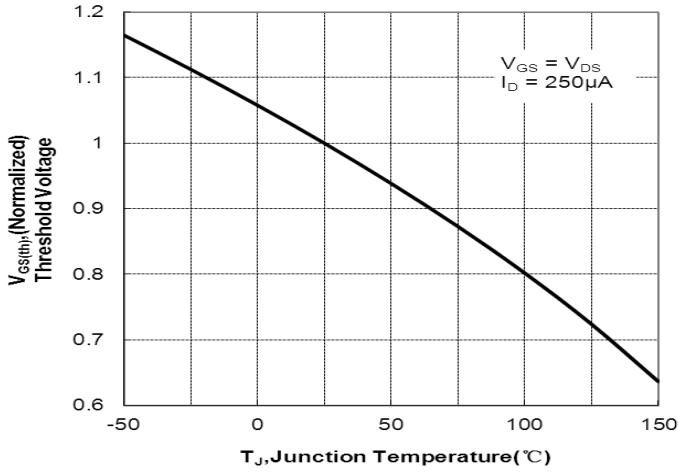

Figure 11 Typical Theshold Voltage vs Junction Temperature

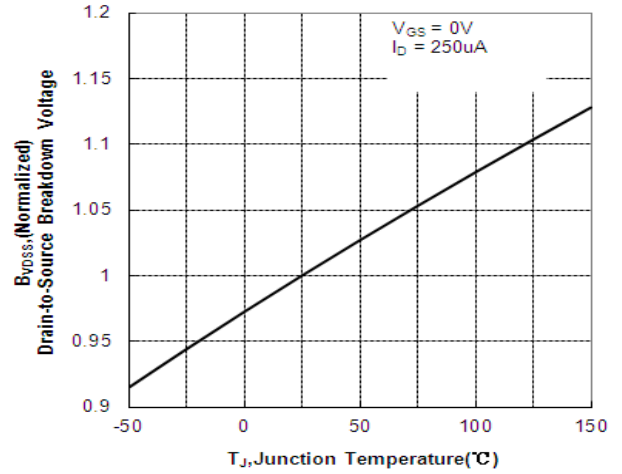

Figure 12 Typical Breakdown Voltage vs Junction Temperature

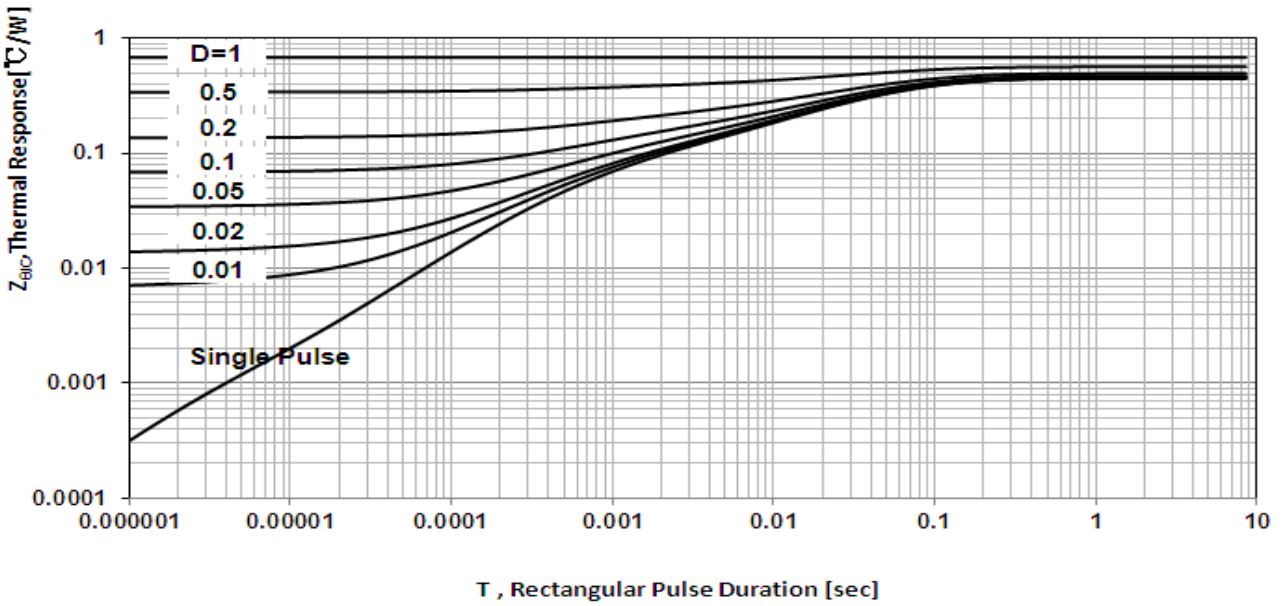

Figure 13 Maximum Effective Transient Thermal Impedance, Junction-to-Case

Test Circuit and Waveform



Figure 17. Gate Charge Test Circuit



Figure 18. Gate Charge Waveform



Figure 19. Resistive Switching Test Circuit

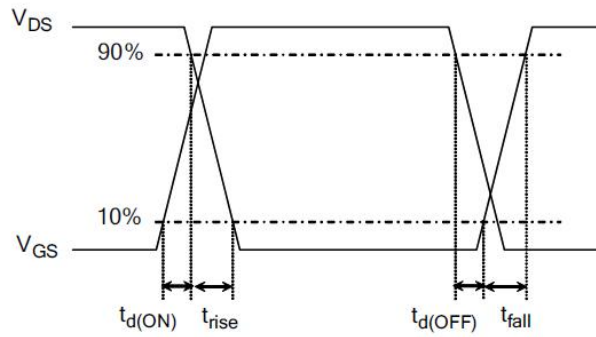

Figure 20. Resistive Switching Waveforms

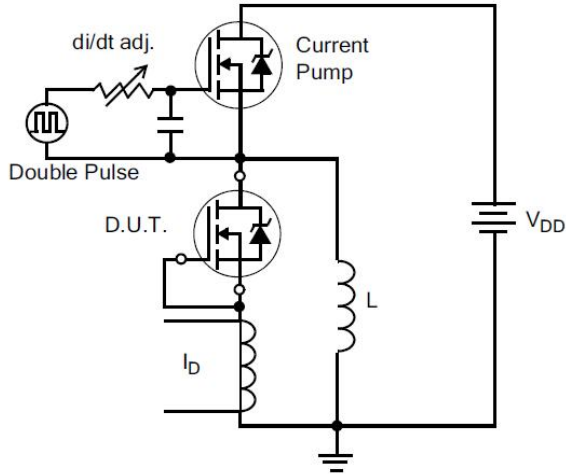

Figure 21. Diode Reverse Recovery Test Circuit



Figure 22. Diode Reverse Recovery Waveform

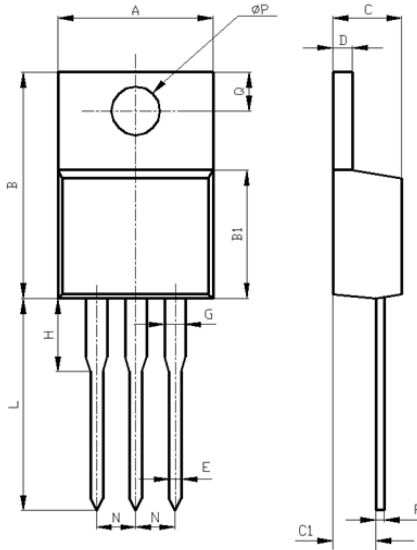

Figure 23. Unclamped Inductive Switching Test Circuit



Figure 24. Unclamped Inductive Switching Waveforms

Package Information:



Items	Values(mm)	
	MIN	MAX
A	9.60	10.6
B	15.0	16.0
B1	8.90	9.50
C	4.30	4.80
C1	2.30	3.10
D	1.20	1.40
E	0.70	0.90
F	0.30	0.60
G	1.17	1.37
H	2.70	3.80
L*	12.6	14.8
N	2.34	2.74
Q	2.40	3.00
φ P	3.50	3.90

*adjustable

TO-220AB Package

