



## SPECIFICATIONS

- MECHANICAL LIFE:** 100,000 make-and-break cycles.
- ELECTRICAL LIFE:** 50,000 cycles.
- CONTACT RESISTANCE:** 200 mΩ max. initial @ 2-4VDC 100mA
- CONTACT RATING:** 0.4Volt-Amps(VA) max.@20V max(AC or DC)
- OPERATING POSITION:** 0.65±0.2mm.
- OPERATING FORCE:** 630±130gf.
- INSULATION RESISTANCE:** 100 MΩ min.
- DIELECTRIC STRENGTH:** 1,000 V RMS@sea level.
- OPERATING TEMPERATURE:** -30°C to 85°C.
- PANEL THICKNESS:** 1.5 mm (.059) min. - 5 mm (.197) max.
- TORQUE:** 2.2 Nm max. applied to nut.

## MATERIALS

- HOUSING & BUSHING:** Nylon 6/6.
- BUTTON:** Stainless steel.
- ACTUATOR:** Silicon.
- CONTACT / TERMINALS:** Copper alloy, with gold plated.



## SCHEMATIC / PANEL MOUNTING

**FUNCTION:** Momentary action

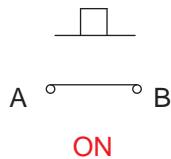
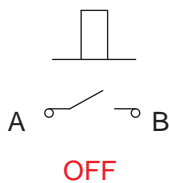

**PANEL CUTOUT**

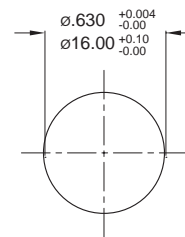

## DIMENSION

**M1**

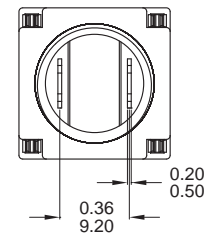
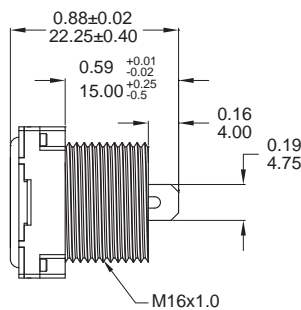
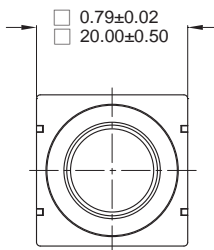

Part No. Shown : PY063S2011X0M1R01

**O-RING**

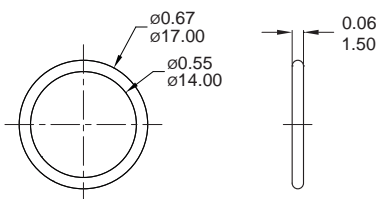

FCP-PY02

**NUT**

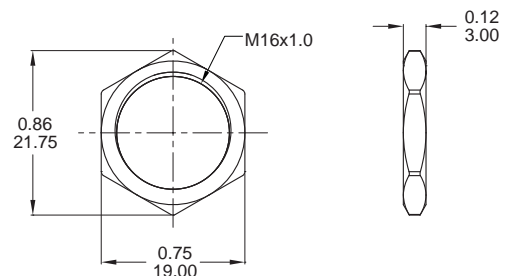

MNU-PY01