

## RT8279 Step-Down Converter Evaluation Board

### ***Purpose***

The RT8279 is a Current mode operation step-down regulator with an internal power MOSFET. This document explains the function and use of the RT8279 evaluation board (EVB) and provides information to enable operation and modification of the evaluation board and circuit to suit individual requirements.

## Table of Contents

Purpose .....	1
Introduction.....	2
General Product Description .....	2
Product Features .....	2
Application.....	2
Evaluation Board .....	3
Specification .....	4
Schematic.....	4
BOM.....	4
PCB Layout .....	5
Step-Down Converter Efficiency Test.....	7
More Information.....	8
Important Notice for Richtek Evaluation Board .....	8

---

## ***Introduction***

### ***General Product Description***

The RT8279 is a step-down regulator with an internal power MOSFET. It achieves 5A of continuous output current over a wide input supply range with excellent load and line regulation. Current mode operation provides fast transient response and eases loop stabilization. For protection, the RT8279 provides cycle-by-cycle current limiting and thermal shutdown protection. An adjustable soft-start reduces the stress on the input source at start up. In shutdown mode, the regulator draws only 25 $\mu$ A of supply current. The RT8279 requires a minimum number of readily available external components, providing a compact solution. The RT8279 is available in the SOP-8 (Exposed Pad) package.

### ***Product Features***

- **5A Output Current**
- **Internal Soft-Start**
- **110m $\Omega$  Internal Power MOSFET Switch**
- **Internal Compensation Minimizes External Parts Count**
- **High Efficiency up to 90%**
- **25 $\mu$ A Shutdown Mode**
- **Fixed 500kHz Frequency**
- **Thermal Shutdown**
- **Cycle-by-Cycle Over Current Protection**
- **Wide 5.5V to 36V Operating Input Range**
- **Adjustable Output Voltage from 1.222V to 26V**
- **Available In an SOP-8 (Exposed Pad) Package**
- **RoHS Compliant and Halogen Free**

### ***Application***

- **Distributive Power Systems**
- **Battery Charger**
- **DSL Modems**
- **Pre-regulator for Linear Regulators**

**Evaluation Board**

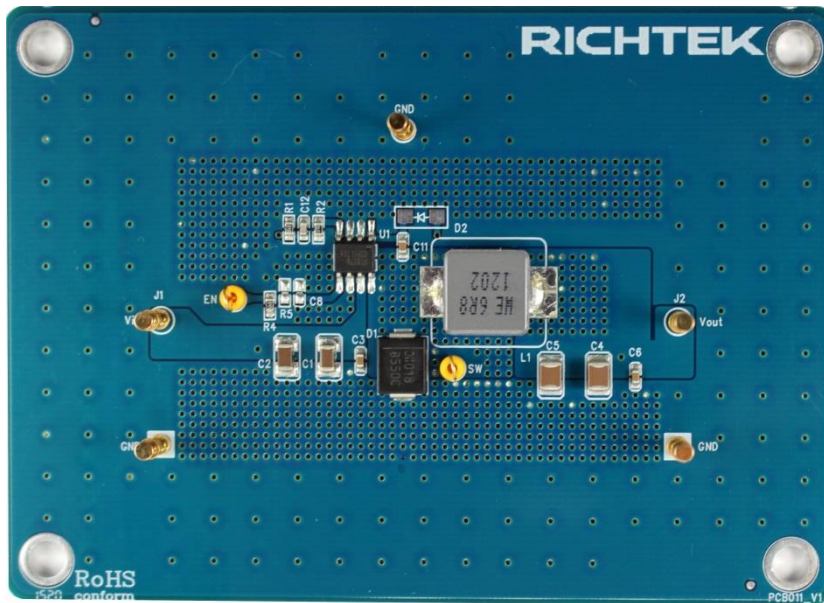

Please carefully inspect the EVB IC and external components, comparing them to the following Bill of Materials, to ensure that all components are installed and undamaged. If any components are missing or damaged during transportation, please contact the distributor or send e-mail to [evb\\_service@richtek.com](mailto:evb_service@richtek.com)

**Test Points**

The EVB is provided with the test points and pin names listed in the table below.

Test point/Pin name	Signal	Comment (expected waveforms or voltage levels on test points)
<b>VIN</b>	Input voltage	Input voltage range = 5.5V to 36V
<b>VOUT</b>	Output voltage	Output voltage = 2.4V
<b>SW</b>	Switch Node	
<b>EN</b>	Chip Enable Operation	The EN pin is externally pulled to High by adding a 100kΩ resistor (R4) from the VIN pin in this EVB setting. For another enable operation, pull the EN pin low (<0.4V) will shutdown the device, drive the EN pin to high (>1.4V, <5.5V) will turn on the device again.
<b>GND</b>	Ground	Ground

**Power-up & Measurement Procedure**

1. Connect input power (5.5V < V<sub>IN</sub> < 36V) and input ground to Vin and GND pins respectively.
2. Connect positive end and negative end of load to VOUT and GND of output pins respectively.
3. The output voltage of (V<sub>OUT</sub>) can be set by R1 and R2.

$$V_{OUT} = V_{REF} * (1 + R1/R2)$$

where V<sub>REF</sub> = 1.222V (typ.)

### Specification

Parameter	Symbol	Min	Typ.	Max	Units
Input Voltage Range	$V_{IN}$	5.5		36	V
Output Voltage	$V_{OUT}$		2.4		V
Oscillator Frequency	$f_{OSC}$	425	500	575	kHz
Output Current	$I_{OUT}$			5	A
Current Limit	$I_{LIM}$	6	7.5	9	A

### Schematic

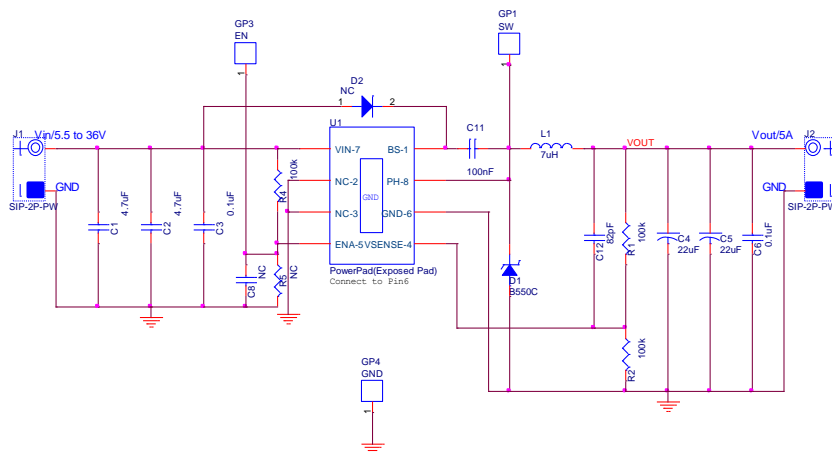

### BOM

Reference	Q'ty	P/N	Description	Package	Manufacture
U1	1	RT8279GSP	Step-down converter	SOP-8	RICHTEK
C1, C2	2	GRM32ER71H475K	4.7µF/50V/X7R	C-1210	MURATA
C3, C6, C11	3	C1608X7R1H104K080AA	0.1µF/±10%/50V/X7R	C-0603	TDK
C4, C5	2	GRM32ER61C226KE20	22µF/±10%/16V/X5R	C-1210	MURATA
C12	1		82pF	C-0603	
L1	1	74437368068	6.8µH, 6A, ±20%, DCR = 23.3mΩ	10 x 10 x 3.8mm	WE-LHMI
D1	1	B550C	50V/5A		DIODES
R1, R2, R4	3		100k	R-0402	
C8, R5	2		NC		

**PCB Layout**

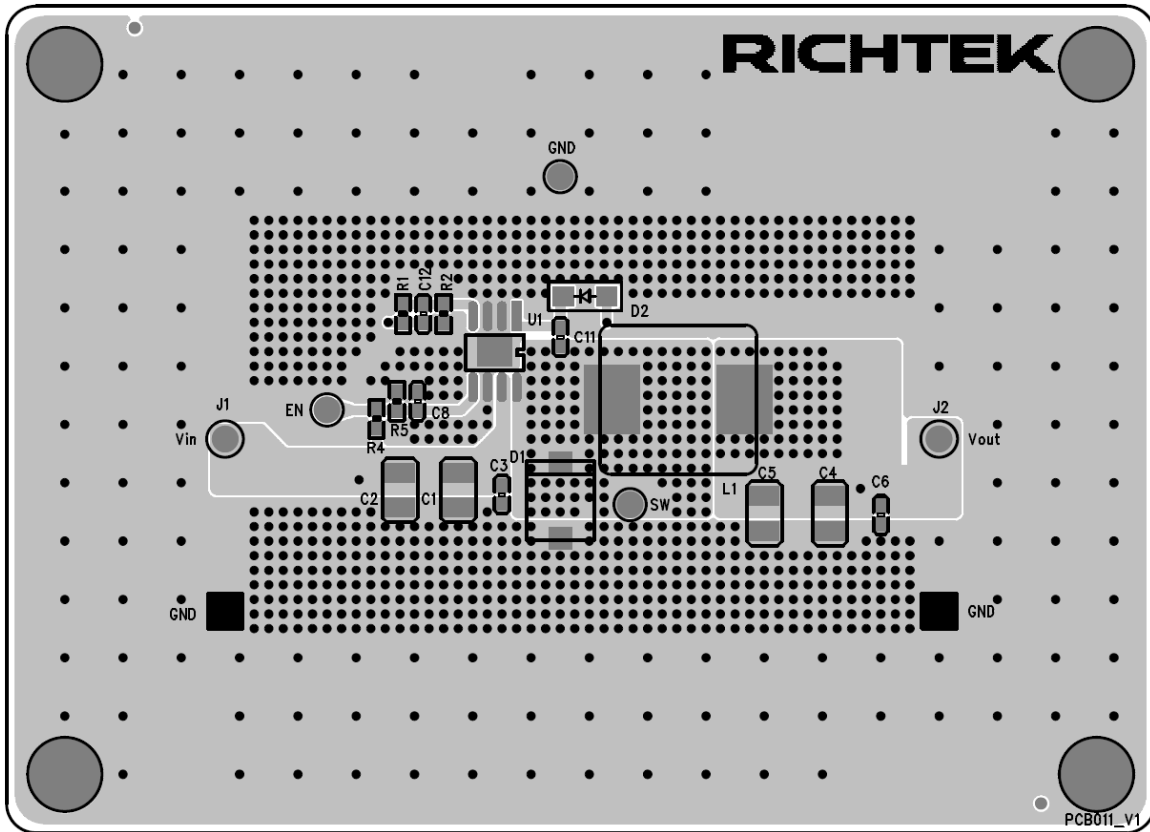

PCS Layout (1<sup>st</sup> layer)

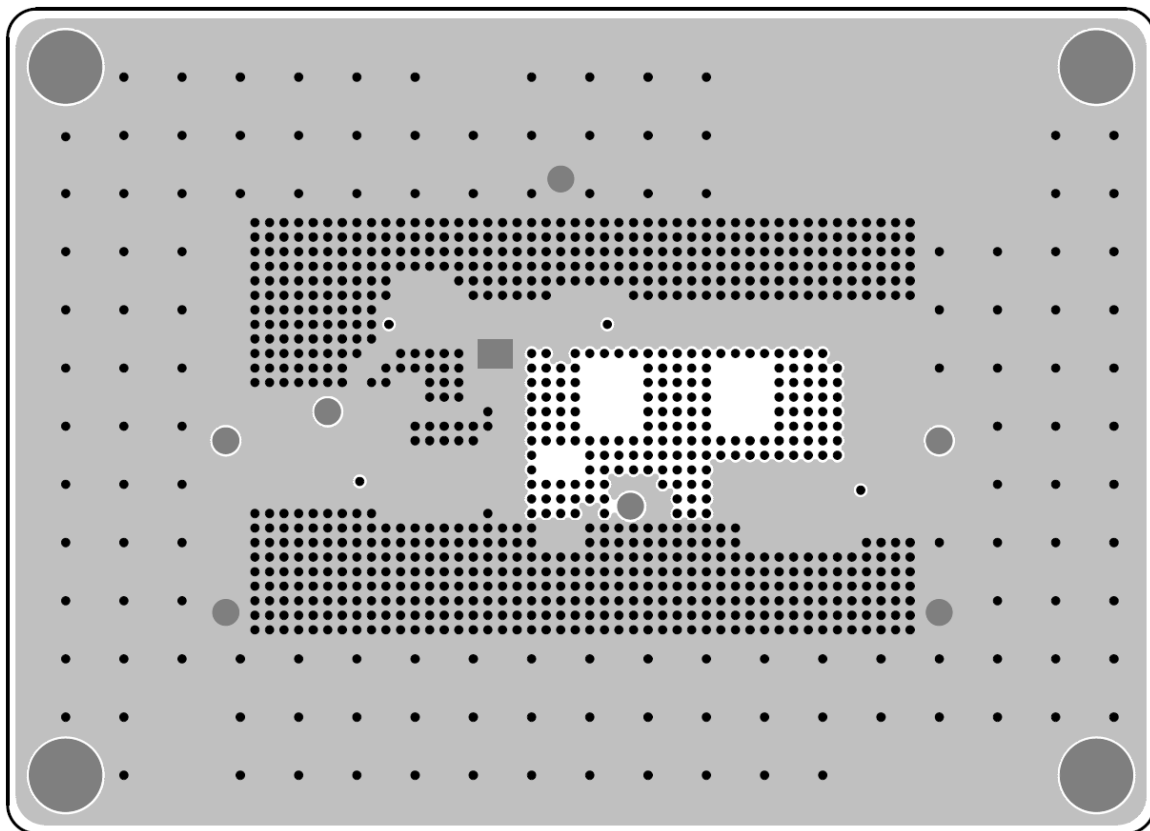

PCS Layout (2<sup>nd</sup> layer)

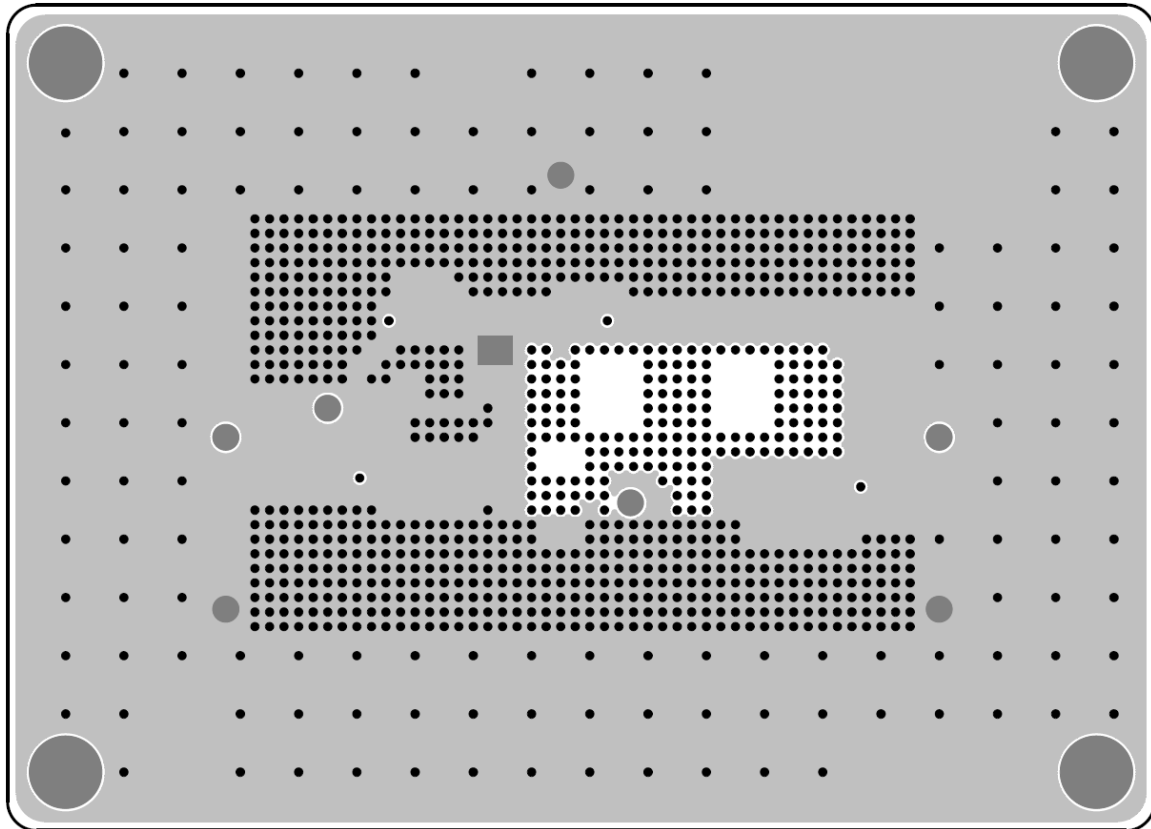

PCS Layout (3<sup>rd</sup> layer)

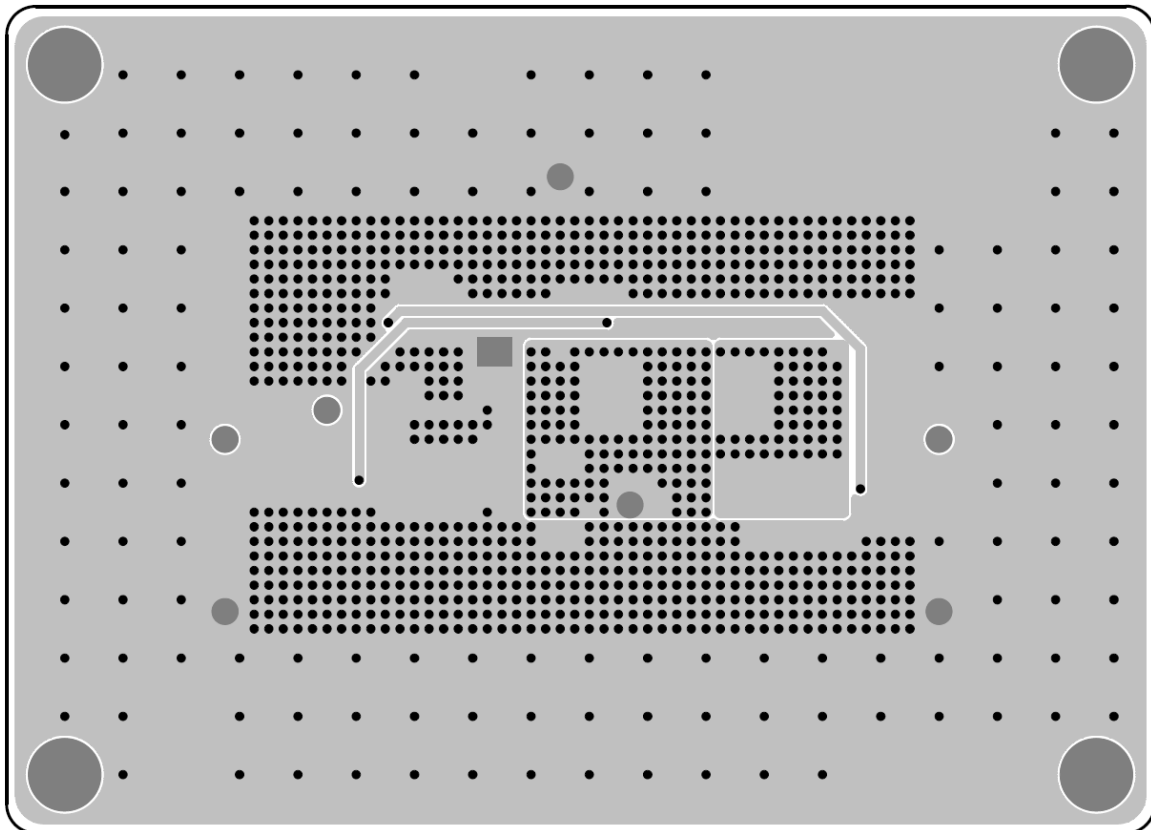

PCS Layout (4<sup>th</sup> layer)

**Step-Down Converter Efficiency Test**

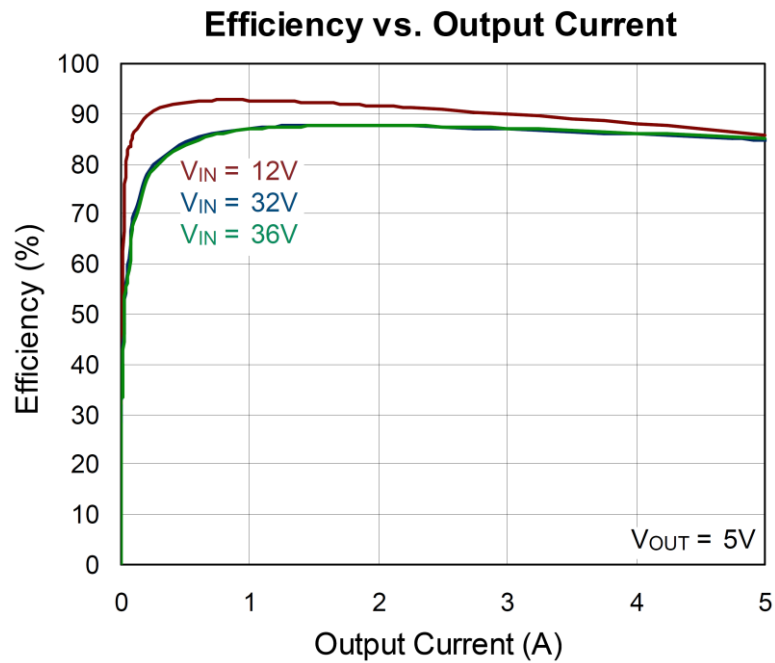

### ***More Information***

For more information, please find the related datasheet or application notes from Richtek website <http://www.richtek.com>.

### ***Important Notice for Richtek Evaluation Board***

THIS DOCUMENT IS FOR REFERENCE ONLY, NOTHING CONTAINED IN THIS DOCUMENT SHALL BE CONSTRUED AS RICHTEK'S WARRANTY, EXPRESS OR IMPLIED, UNDER CONTRACT, TORT OR STATUTORY, WITH RESPECT TO THE PRESENTATION HEREIN. IN NO EVENT SHALL RICHTEK BE LIABLE TO BUYER OR USER FOR ANY AND ALL DAMAGES INCLUDING WITHOUT LIMITATION TO DIRECT, INDIRECT, SPECIAL, PUNITIVE OR CONSEQUENTIAL DAMAGES.