

Unit: mm

Recommended hole size

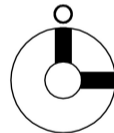
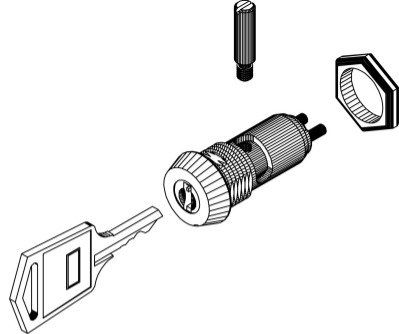
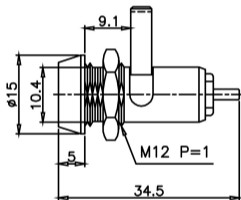
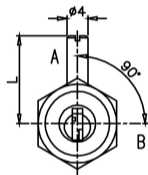

Fig.1

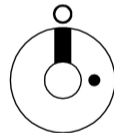



Fig.2

Fig No	Lock Number	Pole	Positions	Terminals	Key Pulls	Turn			Type
1	S1096-1	1	2	2	1	90°	Off	On	SPST
2	S1096-2	1	2	2	2	90°	Off	On	SPST