



## Features

Document No: AX88179A/V1.02/12/21/21

- **Single chip USB 3.2 Gen 1 to Gigabit Ethernet controller with Integrated 1G/100M/10M Base-T PHY**
- **USB Device Controller**
  - Integrates on-chip USB Type-C 3.2 Gen1 PHY and controller compliant to USB Spec 3.2 Gen 1, 2.0 and 1.1
  - Supports all USB 3.2 Gen 1 power saving modes (U0, U1, U2, and U3)
  - Supports USB Super/High/Full Speed modes with Bus-power or Self-power device
- **Gigabit Ethernet Controller**
  - Integrates 10M/100M/1000M Gigabit Ethernet MAC/PHY, compliant to IEEE 802.3, 802.3u and 802.3ab
  - Supports CDC-NCM, CDC-ECM
  - Supports IEEE 802.3az (Energy Efficient Ethernet, EEE)
  - Supports AUTO-MDIX, flow control (IEEE 802.3 Annex.31B)
  - Supports IPv4/IPv6 Packet Checksum Offload Engine (COE)
  - Supports TCP Large Send Offload V1/V2
  - Supports up to 9K Jumbo Frame
  - Supports IEEE 802.1Q VLAN tagging and 4096 VLAN ID filtering; received VLAN tag (4 bytes) can be stripped off or preserved
  - Supports IEEE 802.1P Layer 2 Priority Encoding and Decoding
  - Supports manageability L2 filter
  - Supports TCO filter, L3/L4 IP/Port filter
- Supports Second DA RX filter with bit mask
- **Wake-on-LAN Functions**
  - Supports suspend mode and remote wakeup via link-change, Magic Packet, Microsoft wakeup frame and external wakeup pin
  - Supports Bonjour Wake-on-Demand
  - Supports Wakeup Packet Indication
  - Supports Microsoft Modern Standby
- **Advanced Power Management Features**
  - Supports power management offload (ARP & NS)
  - Supports ECMA-393 ProxZzzy® for sleeping hosts
- **PTP (Precision Time Protocol)**
  - Supports IEEE 1588v2 and 802.1AS
- **Supports Windows 10/8.x, Linux/Android /Chrome OS, Nintendo Switch in-box drivers, and macOS/Linux native CDC-NCM driver for driverless, Plug & Play**
- **Supports embedded eFuse for die identifier and store the USB Device Descriptors, Node-ID, etc.**
- **Supports SPI Flash for firmware customization**
- **Single 20 MHz crystal clock source**
- **Integrates on-chip power-on reset circuit**
- **40-pin QFN, 5x5 mm package**
- **Operating Temperature Range: 0 to +70°C**

## Target Applications

- Notebook/Laptop Onboard LAN
- USB Ethernet Dongle for Ultrabook /Table/Smart Phone/etc.
- Docking Station, POS/PDA Cradle
- IP STB, Smart Camera, Smart TV Box
- Game Console
- 5G/LTE Router/Gateway



Typical Applications Diagram



Figure 0-1: AX88179A Typical Applications Diagram



Copyright © 2020-2021 ASIX Electronics Corporation. All rights reserved.

**DISCLAIMER**

No part of this document may be reproduced or transmitted in any form or by any means, electronic or mechanical, including photocopying and recording, for any purpose, without the express written permission of ASIX. ASIX may make changes to the product specifications and descriptions in this document at any time, without notice.

ASIX provides this document “as is” without warranty of any kind, either expressed or implied, including without limitation warranties of merchantability, fitness for a particular purpose, and non-infringement.

Designers must not rely on the absence or characteristics of any features or registers marked “reserved”, “undefined” or “NC”. ASIX reserves these for future definition and shall have no responsibility whatsoever for conflicts or incompatibilities arising from future changes to them. Always contact ASIX to get the latest document before starting a design of ASIX products.

**TRADEMARKS**

ASIX, the ASIX logo are registered trademarks of ASIX Electronics Corporation. All other trademarks are the property of their respective owners.



## Table of Contents

<b>1</b>	<b>INTRODUCTION .....</b>	<b>6</b>
1.1	GENERAL DESCRIPTION .....	6
1.2	BLOCK DIAGRAM.....	6
1.3	PINOUT DIAGRAM.....	7
1.4	SIGNAL DESCRIPTION .....	8
1.4.1	USB Interface.....	8
1.4.2	Clock.....	8
1.4.3	GPHY MDI.....	8
1.4.4	Misc Pin.....	9
1.4.5	Power and Ground Pin.....	9
<b>2</b>	<b>FUNCTION DESCRIPTION.....</b>	<b>10</b>
2.1	CLOCKS/RESETS .....	10
2.2	USB CORE AND INTERFACES.....	10
2.3	10/100/1000M ETHERNET PHY .....	10
2.4	ENERGY EFFICIENT ETHERNET (EEE) .....	10
2.5	CHECKSUM OFFLOAD ENGINE (COE).....	11
2.6	USB TO ETHERNET BRIDGE.....	11
2.7	eFUSE .....	11
2.8	GENERAL PURPOSE I/O AND LED.....	11
<b>3</b>	<b>SPI/EFUSE MEMORY .....</b>	<b>12</b>
3.1	SPI/EFUSE MEMORY.....	12
<b>4</b>	<b>USB CONFIGURATION STRUCTURE .....</b>	<b>12</b>
4.1	USB CONFIGURATION .....	12
4.2	USB INTERFACE.....	12
4.3	USB ENDPOINTS.....	12
<b>5</b>	<b>ELECTRICAL SPECIFICATIONS .....</b>	<b>13</b>
5.1	DC CHARACTERISTICS.....	13
5.1.1	Recommended Operating Condition .....	13
5.1.2	DC Characteristics of 3.3V I/O Pins.....	13
5.2	POWER CONSUMPTION.....	14
5.3	POWER-ON-RESET (POR) SPECIFICATION .....	16
5.4	POWER-UP SEQUENCE.....	17
5.5	AC TIMING CHARACTERISTICS.....	18
5.5.1	SPI Timing .....	18
5.5.2	Clock Timing.....	19
5.5.3	Reset Timing.....	19
<b>6</b>	<b>PACKAGE INFORMATION.....</b>	<b>20</b>
<b>7</b>	<b>ORDERING INFORMATION.....</b>	<b>21</b>
<b>8</b>	<b>REVISION HISTORY .....</b>	<b>21</b>



### List of Figures

FIGURE 0-1: AX88179A TYPICAL APPLICATIONS DIAGRAM..... 2  
 FIGURE 1-1: AX88179A BLOCK DIAGRAM ..... 6  
 FIGURE 1-2: AX88179A PINOUT DIAGRAM ..... 7  
 FIGURE 5-1: POWER ON RESET (POR) TIMING DIAGRAM ..... 16  
 FIGURE 5-2: POWER-UP SEQUENCE TIMING DIAGRAM ..... 17  
 FIGURE 5-3: SPI TIMING..... 18  
 FIGURE 5-4: CLOCK TIMING DIAGRAM..... 19

### List of Tables

TABLE 1-1: USB INTERFACE PIN DESCRIPTION ..... 8  
 TABLE 1-2: CLOCK PIN DESCRIPTION ..... 8  
 TABLE 1-3: GPHY MDI PIN DESCRIPTION ..... 8  
 TABLE 1-4: MISC PIN DESCRIPTION..... 9  
 TABLE 1-5: POWER AND GROUND PIN DESCRIPTION ..... 9  
 TABLE 5-1: AX88179A POWER CONSUMPTION ..... 14  
 TABLE 5-2: THERMAL CHARACTERISTICS ..... 15  
 TABLE 5-3: POWER ON RESET (POR) TIMING TABLE..... 16  
 TABLE 5-4: POWER-UP SEQUENCE TIMING TABLE ..... 17  
 TABLE 5-5: SPI TIMING TABLE..... 18  
 TABLE 5-6: CLOCK TIMING TABLE..... 19  
 TABLE 5-7: RESET TIMING TABLE ..... 19



# 1 Introduction

## 1.1 General Description

The AX88179A USB 3.2 Gen1 to 10/100/1000M Gigabit Ethernet controller is a high performance and highly integrated ASIC which enables low cost, small form factor, and simple plug-and-play Gigabit Ethernet network connection capability for desktops, notebook PC's, Ultrabook's, docking stations, game consoles, digital-home appliances, and any embedded system using a standard USB port.

The AX88179A features a USB interface to communicate with a USB Host Controller and is compliant with USB specification V3.2 Gen1, V2.0, and V1.1. It implements a 10/100/1000Mbps Ethernet LAN function based on IEEE802.3, IEEE802.3u, and IEEE802.3ab standards with embedded SRAMs for packet buffering. And, it also integrates an on-chip 10/100/1000Mbps IEEE-compliant Ethernet PHY to simplify system design.

## 1.2 Block Diagram

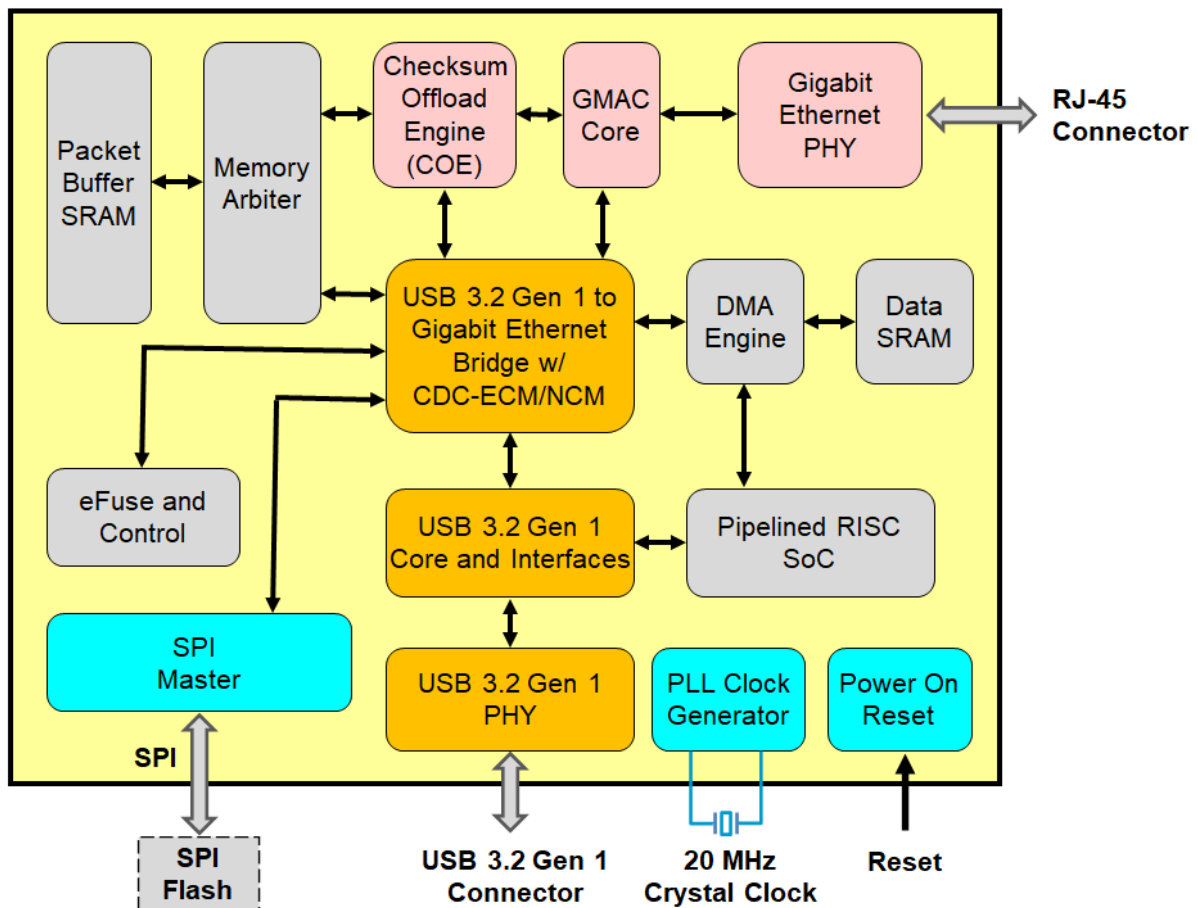

Figure 1-1: AX88179A Block Diagram



### 1.3 Pinout Diagram

AX88179A is housed in a 40-pin E-PAD QFN package.

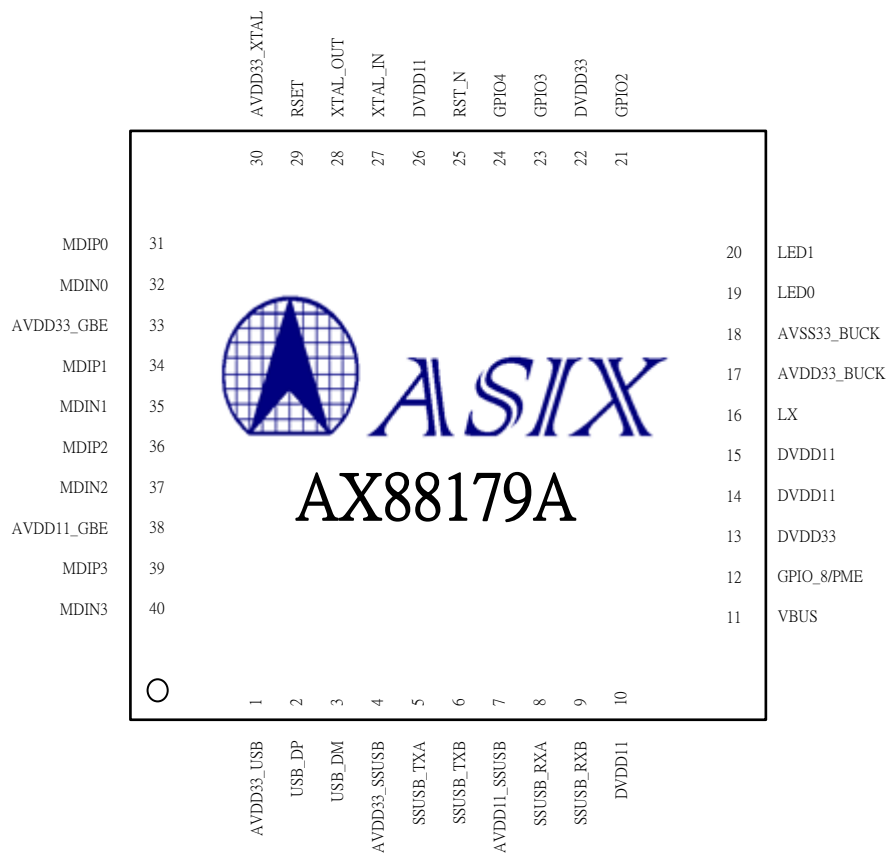

Figure 1-2: AX88179A Pinout Diagram



### 1.4 Signal Description

Following abbreviations are used in “Type” column of below pin description tables. Note that some I/O pins with multiple signal definitions on the same pin may have different attributes in “Type” column for different signal definition.

<b>AB</b>	Analog Bi-directional I/O	<b>PU</b>	Internal Pull-Up (75K)
<b>AI</b>	Analog Input	<b>PD</b>	Internal Pull-Down (75K)
<b>AO</b>	Analog Output	<b>P</b>	Power/Ground pin
<b>B5</b>	Bi-directional I/O, 3.3V with 5V tolerant	<b>S</b>	Schmitt Trigger
<b>I5</b>	Input, 3.3V with 5V tolerant	<b>T</b>	Tri-state
<b>O5</b>	Output, 3.3V with 5V tolerant	<b>4m</b>	4mA driving strength
<b>I3</b>	Input, 3.3V	<b>8m</b>	8mA driving strength
<b>O3</b>	Output, 3.3V		

#### 1.4.1 USB Interface

Pin Name	Type	Pin No	Pin Description
USB_DP	AB	2	USB 2.0 data differential pair positive pin.
USB_DM	AB	3	USB 2.0 data differential pair negative pin.
SSUSB_TXA	AO	5	USB 3.2 Gen 1 TX differential pair pin A.
SSUSB_TXB	AO	6	USB 3.2 Gen 1 TX differential pair pin B.
SSUSB_RXA	AI	8	USB 3.2 Gen 1 RX differential pair pin A.
SSUSB_RXB	AI	9	USB 3.2 Gen 1 RX differential pair pin B.

Table 1-1: USB Interface Pin Description

#### 1.4.2 Clock

Pin Name	Type	Pin No	Pin Description
XTAL_IN	I3	27	20Mhz crystal or oscillator clock input.
XTAL_OUT	O3	28	20Mhz crystal or oscillator clock output.

Table 1-2: Clock Pin Description

#### 1.4.3 GPHY MDI

Pin Name	Type	Pin No	Pin Description
MDIP0	AB	31	MDI pair 0 positive pin
MDIN0	AB	32	MDI pair 0 negative pin
MDIP1	AB	34	MDI pair 1 positive pin
MDIN1	AB	35	MDI pair 1 negative pin
MDIP2	AB	36	MDI pair 2 positive pin
MDIN2	AB	37	MDI pair 2 negative pin
MDIP3	AB	39	MDI pair 3 positive pin
MDIN3	AB	40	MDI pair 3 negative pin

Table 1-3: GPHY MDI Pin Description





### 1.4.4 Misc Pin

Pin Name	Type	Pin No	Pin Description
RSET	AB	29	External Reference Resistor (24 KΩ, 1%) Connect resistor to Analog GND.
VBUS	I3/S	11	VBUS signal of USB.
RST_N	I3/S/PU	25	Reset signal. Active low
GPIO_2	B3/S	21	Clock pin of SPI.
GPIO_3	B3/S	23	SPI data I/O pin if GPIO_4 pulled up.
GPIO_4	B3/S	24	If pulled up, CS pin of SPI
GPIO_8/PME*	B3/S/PU	12	PME pin for power management, always pull up this pin.
LED_0	B3	19	Programmable LED_0 indication
LED_1	B3	20	Programmable LED_1 indication

\*: It is a multi-function pin. The default is an external wakeup pin. Active low. PME pin needs to set by tool.

Table 1-4: Misc Pin Description

### 1.4.5 Power and Ground Pin

Pin Name	Type	Pin No	Pin Description
AVDD33_USB	P	1	3.3V Analog Power Input of USB.
AVDD33_SSUSB	P	4	3.3V Analog Power Input of SS USB.
AVDD11_SSUSB	P	7	1.1V Analog Power Input of SS USB.
DVDD11	P	10	1.1V Digital Power.
DVDD33	P	13	3.3V I/O Power.
DVDD11	P	14	1.1V Digital Power.
DVDD11	P	15	1.1V Digital Power.
LX	P	16	This 1.1V power pin drives external inductors for on-die BUCK.
AVDD33_BUCK	P	17	3.3V Analog Power for on-die BUCK.
AVSS33_BUCK	P	18	3.3V Analog Ground for on-die BUCK.
DVDD33	P	22	3.3V I/O Power.
DVDD11	P	26	1.1V Digital Power.
AVDD33_XTAL	P	30	3.3V Analog Power for crystal pad.
AVDD33_GBE	P	33	3.3V Analog Power for Ethernet PHY.
AVDD11_GBE	P	38	1.1V Analog Power for Ethernet PHY.

Table 1-5: Power and Ground Pin Description



## 2 Function Description

### 2.1 Clocks/Resets

The AX88179A integrates internal oscillator circuits for 20 MHz (20MHz  $\pm$  50PPM at room temperature), respectively, which allow the chip to operate cost effectively with just one single external 20 MHz crystal.

The external 20 MHz crystal or oscillator, via pins XTAL\_IN / XTAL\_OUT, provides the reference clock to internal oscillation circuit to generate clock source for the embedded Ethernet PHY, embedded USB PHY, and base clock for ASIC use.

The AX88179A integrates an internal power-on-reset circuit, which can simplify the external reset circuitry on PCB design. The power-on-reset circuit generates a reset pulse to reset chip logic after 1.1V core power ramping up to 0.72V (typical threshold). The external hardware reset input pin, RST\_N, is fed directly to the input of the power-on-reset circuit and can also be used as additional hardware reset source to reset the system logic. For more details on RST\_N timing, please refer to the Reset timing section.

### 2.2 USB Core and Interfaces

The USB core and interfaces contains USB 3.2 Gen1/USB 2.0 transceiver interfaces (PIPE/UTMI) and USB 3.2 Gen1/USB 2.0 Device Controller.

The USB 3.2 Gen1/USB 2.0 transceiver (or PHY) processes USB 3.2 Gen1/2.0/1.1 Physical layer signals. And, The USB 3.2 Gen1/USB 2.0 Device Controller is interfacing with USB 3.2 Gen1/USB 2.0 transceiver by PIPE/UTMI buses and it processes packets of Link layer and protocol layer. Also, The USB 3.2 Gen1/USB 2.0 Device Controller contains Bulk IN and Bulk OUT buffers for handling Bulk transfer traffic and a FIFO for Interrupt IN transfers.

The USB core and interfaces are used to communicate with a USB host controller and is compliant with USB specification V3.2 Gen1, V2.0, and V1.1

### 2.3 10/100/1000M Ethernet PHY

The 10/100/1000M Ethernet PHY is compliant with 10Base-T, 100Base-TX, and 1000Base-T IEEE 802.3 standards. It provides all the necessary physical layer functions to transmit and receive Ethernet packets over CAT 5e UTP cable or CAT 3 UTP (10Mbps only) cable. It uses DSP technology and an Analog Front End (AFE) to enable high-speed data transmission and reception over UTP cable. Functions such as Crossover Detection & Auto-Correction (Auto-MDIX), polarity correction, adaptive equalization, cross-talk cancellation, echo cancellation, timing recovery, and error correction are implemented.

### 2.4 Energy Efficient Ethernet (EEE)

It supports IEEE 802.3az also known as Energy Efficient Ethernet (EEE). And also supports EEE specified a negotiation method to enable link partner to determine whether EEE is supported and to select the best set of parameters common to both devices. It provides a protocol to coordinate transitions to/from a lower power consumption level (Low Power Idle mode) based on link utilization. When no packets are being transmitted, the system goes to Low Power Idle mode to save power. Once packets need to be transmitted, the system returns to normal mode, and does this without changing the link status and without dropping/corrupting frames.

To save power, when the system is in Low Power Idle mode, most of the circuits are disabled; however, the transition time to/from Low Power Idle mode is kept small enough to be transparent to upper layer protocols and applications.



## 2.5 Checksum Offload Engine (COE)

The Checksum Offload Engine (COE) supports IPv4, IPv6, layer 4 (TCP, UDP, ICMP, ICMPv6 and IGMP) header processing functions and real time checksum calculation in hardware

The COE supports the following features in layer 3:

- IP header parsing, including IPv4 and IPv6
- IPv6 extension header and routing header type 0 supported
- IPv4 header checksum check and generation (There is no checksum field in IPv6 header)
- Detecting on RX direction for IP packets with error header checksum

The COE supports the following features in layer 4:

- TCP and UDP checksum check and generation for non-fragmented packet
- TCP Large Send Offload V2
- ICMP, ICMPv6 and IGMP message checksum check and generation for non-fragmented packet

## 2.6 USB to Ethernet Bridge

The USB to Ethernet bridge block is responsible for converting Ethernet MAC frame into USB packets or vice-versa. This block supports proprietary burst transfer mechanism (US Patent Approval) to offload software burden and to offer very high packet transfer throughput over USB bus.

This USB to Ethernet bridge block not only co-work with “eFuse and Control”, “SPI Loader I/F”, and General Purpose I/Os and LEDs, but also handle USB Control transfers of Endpoint 0.

## 2.7 eFuse

The AX88179A integrated an eFuse which is allowed user to program USB descriptions (PID, VID, Serial numbers... ect) and some device information (MAC address). And ASIX advance data structures allow user to program this information for multiple times.

## 2.8 General Purpose I/O and LED

There are 3 general-purpose I/O pins for SPI flash and 2 LED pins for LED indication.



## **3 SPI/eFuse Memory**

### **3.1 SPI/eFuse Memory**

AX88179A supports integrated eFuse and external SPI flash for MAC address, USB descriptor and several user specified information. These non-violated memory supports advance data architecture for multiple times programming.

## **4 USB Configuration Structure**

### **4.1 USB Configuration**

The AX88179A supports 2 USB Configuration, 1 for AX88179A proprietary driver, 1 for CDC-ECM/NCM

### **4.2 USB Interface**

The AX88179A supports 1 interface.

### **4.3 USB Endpoints**

The AX88179A supports following 4 endpoints:

Endpoint 0: Control endpoint. It is used for configuring the device. Please refer to the USB Standard Commands and USB Vendor Commands sections.

Endpoint 1: Interrupt endpoint. It is used for reporting network Link status. Please refer to the Interrupt Endpoint section.

Endpoint 2: Bulk IN endpoint. It is used for receiving Ethernet Packet.

Endpoint 3: Bulk OUT endpoint. It is used for transmitting Ethernet Packet.



## 5 Electrical Specifications

### 5.1 DC Characteristics

#### 5.1.1 Recommended Operating Condition

Symbol	Parameter	Min	Typ	Max	Units
AVDD33_USB	3.3V Analog Power Input of USB.	2.97	3.3	3.63	V
AVDD33_SSUSB	3.3V Analog Power Input of SS USB.	2.97	3.3	3.63	V
AVDD11_SSUSB	1.1V Analog Power Input of SS USB.	1.045	1.1	1.155	V
DVDD11	1.1V Digital Power.	1.045	1.1	1.155	V
DVDD33	3.3V I/O Power.	2.97	3.3	3.63	V
AVDD33_BUCK	3.3V Analog Power Input of BUCK.	2.97	3.3	3.63	V
AVDD33_XTAL	3.3V Analog Power Input of Crystal.	2.97	3.3	3.63	V
AVDD33_GBE	3.3V Analog Power Input of Ethernet PHY.	2.97	3.3	3.63	V
AVDD11_GBE	1.1V Analog Power Input of Ethernet PHY.	1.045	1.1	1.155	V
T <sub>j</sub>	Operating junction temperature	0	25	125	°C
T <sub>a</sub>	Operating ambient temperature	0	-	70	°C
T <sub>STG</sub>	Storage temperature	-65	-	150	°C

#### 5.1.2 DC Characteristics of 3.3V I/O Pins

Symbol	Parameter	Conditions	Min	Typ	Max	Units
DVDD33	Power supply of 3.3V I/O.	3.3V I/O	2.97	3.3	3.63	V
V <sub>il</sub>	Input low voltage.	LVTTL	-	-	0.8	V
V <sub>ih</sub>	Input high voltage.		2.0	-	-	V
V <sub>t-</sub>	Schmitt trigger negative going threshold voltage.	LVTTL	0.8	1.1	-	V
V <sub>t+</sub>	Schmitt trigger positive going threshold voltage		-	1.6	2.0	V
V <sub>ol</sub>	Output low voltage.	I <sub>ol</sub> = 4 ~ 8mA	-	-	0.4	V
V <sub>oh</sub>	Output high voltage.	I <sub>oh</sub> = 4 ~ 8mA	DVDD33 -0.4	-	-	V
V <sub>opu</sub> <sup>(1)</sup>	Output pull-up voltage for 5V tolerant IO	With internal pull-up resistor	DVDD33 -0.9	-	-	V
R <sub>pu</sub>	Input pull-up resistance.		40	75	190	KΩ
R <sub>pd</sub>	Input pull-down resistance.		40	75	190	KΩ
I <sub>in</sub>	Input leakage current.	V <sub>in</sub> = 3.3 or 0V	-	±6	-	μA
	Input leakage current with pull-up resistance.	V <sub>in</sub> = 0 V	-	-45	-	μA
	Input leakage current with pull-down resistance.	V <sub>in</sub> = DVDD33	-	45	-	μA

Note: This parameter indicates that the pull-up resistor for the I/O pins cannot reach DVDD33 DC level even without DC loading current.



## 5.2 Power Consumption

Symbol	Description	Conditions	Typ	Unit
I <sub>VDD11</sub>	Current Consumption of 1.1V	Operating at Ethernet 1Gbps full duplex mode and USB Super Speed mode	104.3	mA
I <sub>VDD33</sub>	Current Consumption of 3.3V		90.5	mA
I <sub>VDD11</sub>	Current Consumption of 1.1V	Operating at Ethernet 100Mbps full duplex mode and USB Super Speed mode	73.4	mA
I <sub>VDD33</sub>	Current Consumption of 3.3V		42.6	mA
I <sub>VDD11</sub>	Current Consumption of 1.1V	Operating at Ethernet 100Mbps half duplex mode and USB Super Speed mode	73.3	mA
I <sub>VDD33</sub>	Current Consumption of 3.3V		42.6	mA
I <sub>VDD11</sub>	Current Consumption of 1.1V	Operating at Ethernet 10Mbps half duplex mode and USB Super Speed mode	63.5	mA
I <sub>VDD33</sub>	Current Consumption of 3.3V		32.7	mA
I <sub>VDD11</sub>	Current Consumption of 1.1V	Operating at Ethernet 1Gbps full duplex mode and USB High Speed mode	64	mA
I <sub>VDD33</sub>	Current Consumption of 3.3V		90.1	mA
I <sub>VDD11</sub>	Current Consumption of 1.1V	Operating at Ethernet 100Mbps full duplex mode and USB High Speed mode	34	mA
I <sub>VDD33</sub>	Current Consumption of 3.3V		33.2	mA
I <sub>VDD11</sub>	Current Consumption of 1.1V	Operating at Ethernet 100Mbps half duplex mode and USB Super Speed mode	33.8	mA
I <sub>VDD33</sub>	Current Consumption of 3.3V		29.7	mA
I <sub>VDD11</sub>	Current Consumption of 1.1V	Operating at Ethernet 10Mbps half duplex mode and USB High Speed mode	22.6	mA
I <sub>VDD33</sub>	Current Consumption of 3.3V		38.5	mA
I <sub>VDD11</sub>	Current Consumption of 1.1V	Operating at Ethernet 1Gbps full duplex mode and USB Full Speed mode	59.4	mA
I <sub>VDD33</sub>	Current Consumption of 3.3V		75	mA
I <sub>VDD11</sub>	Current Consumption of 1.1V	Operating at Ethernet 100Mbps full duplex mode and USB Full Speed mode	30.7	mA
I <sub>VDD33</sub>	Current Consumption of 3.3V		31	mA
I <sub>VDD11</sub>	Current Consumption of 1.1V	Operating at Ethernet 100Mbps half duplex mode and USB Full Speed mode	30.6	mA
I <sub>VDD33</sub>	Current Consumption of 3.3V		26	mA
I <sub>VDD11</sub>	Current Consumption of 1.1V	Operating at Ethernet 10Mbps half duplex mode and USB Full Speed mode	21.4	mA
I <sub>VDD33</sub>	Current Consumption of 3.3V		23	mA
I <sub>VDD11</sub>	Current Consumption of 1.1V	Ethernet unlink (Disable AutoDetach) and USB Super Speed mode	62.8	mA
I <sub>VDD33</sub>	Current Consumption of 3.3V		31.2	mA
I <sub>VDD11</sub>	Current Consumption of 1.1V	Ethernet unlink (Enable AutoDetach)	14.7	mA
I <sub>VDD33</sub>	Current Consumption of 3.3V		7.3	mA
I <sub>VDD11</sub>	Current Consumption of 1.1V	USB Suspend and Ethernet is 1Gbps: enable Remote WakeUp and disable WOLLP (WOL Low Power)	57.7	mA
I <sub>VDD33</sub>	Current Consumption of 3.3V		70.6	mA
I <sub>VDD11</sub>	Current Consumption of 1.1V	USB Suspend and enable Remote WakeUp and enable WOLLP to 10Mbps	19.4	mA
I <sub>VDD33</sub>	Current Consumption of 3.3V		11.9	mA
I <sub>VDD11</sub>	Current Consumption of 1.1V	Suspend and disable Remote WakeUp	0.8	mA
I <sub>VDD33</sub>	Current Consumption of 3.3V		0	mA
System				
I <sub>VDD11</sub>	Current Consumption of 1.1V	Operating at Ethernet 1Gbps mode and USB Super Speed mode (Ethernet linked in EEE)	58.8	mA
I <sub>VDD33</sub>	Current Consumption of 3.3V		70.3	mA
I <sub>VDD11</sub>	Current Consumption of 1.1V	Operating at Ethernet 1Gbps mode and USB Super Speed mode (Ethernet linked in non-EEE)	103	mA
I <sub>VDD33</sub>	Current Consumption of 3.3V		89.5	mA
I <sub>VDD11</sub>	Current Consumption of 1.1V	USB Suspend and enable Remote WakeUp (Ethernet linked in EEE 1Gbps mode)	19.2	mA
I <sub>VDD33</sub>	Current Consumption of 3.3V		11.9	mA
I <sub>VDD11</sub>	Current Consumption of 1.1V	USB Suspend and enable Remote WakeUp (Ethernet linked in non-EEE 1Gbps mode)	58.7	mA
I <sub>VDD33</sub>	Current Consumption of 3.3V		69.9	mA
I <sub>DEVICE</sub>	Power consumption of AX88179A full loading (chip only)	1.1V	104.3	mA
		3.3V	90.5	mA
I <sub>SYSTEM</sub>	Power consumption of AX88179A full loading (test board)	VBUS of 5.0V (Using Switching regulator with two ports:1.1/3.3V)	133.9	mA
I <sub>SYSTEM (Suspend)</sub>	Power consumption of AX88179A (test board): Suspend and disable Remote WakeUp.	VBUS of 5.0V (Using Switching regulator with two ports:1.1/3.3V)	0.7	mA

Note: Above current value are typical values measured on AX88179A Test board.

Table 5-1: AX88179A Power Consumption



Symbol	Description	Condition	Min	Typ	Max	Unit
$\Theta_{JC}$	Thermal resistance of junction to case		-	18.5	-	°C/W
$\Theta_{JA}$	Thermal resistance of junction to ambient	Still Air	-	32.9	-	°C/W
$\Theta_{JB}$	Thermal resistance of junction to board (PCB 4L)		-	9	-	°C/W
$\Psi_{JT}$	Junction to Top of the Package Characterization Parameter		-	0.67	-	°C/W

Table 5-2: Thermal Characteristics



### 5.3 Power-On-Reset (POR) Specification

Below figures and table show the two POR circuit spec during power ramp-up/down.

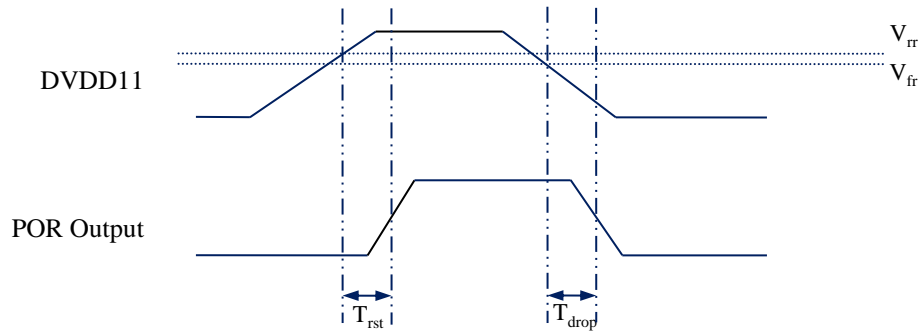

Figure 5-1: Power On Reset (POR) Timing Diagram

Symbol	Description	Conditions	Min.	Typ.	Max.	Units
DVDD11	Power supply voltage to be detected	-	1.045	1.1	1.155	V
$V_{rr}$	DVDD11 rise relax voltage	-	-	0.85	0.9	V
$V_{fr}$	DVDD11 fall release voltage	-	-	0.63	0.80	V
$T_{rst}$	Reset time after POR trigger up	DVDD11 slew rate = 1.0V / 1 $\mu$ s	1.8	2.5	4.8	$\mu$ s
$T_{drop}$	Drop time of DVDD11 to reset	DVDD11 slew rate = 2.5V / 1 $\mu$ s	0.2	0.4	0.9	$\mu$ s

Table 5-3: Power On Reset (POR) Timing Table





### 5.4 Power-up Sequence

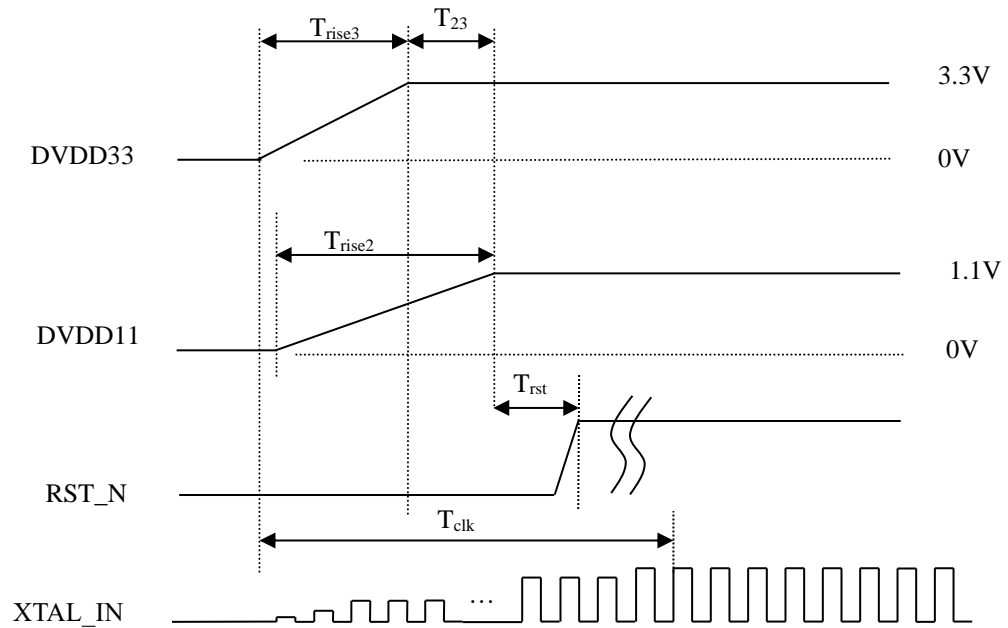

Figure 5-2: Power-up Sequence Timing Diagram

Symbol	Parameter	Conditions	Min	Typ	Max	Units
$T_{rise3}$	3.3V power supply rise time.	From 0V to 3.3V.	-	400	-	us
$T_{rise2}$	1.1V power supply rise time.	From 0V to 1.1V.	-	200	-	us
$T_{23}$	Interval between DVDD33 rising to 2.64V(80%) to DVDD11 rising to 0.88V(80%)		2	-	4	ms
$T_{rst}$	RST_N asserted low level interval.	From DVDD33 rising to 3.3V to RST_N going high.	-	40	-	us
$T_{clk}$	20MHz crystal oscillator start-up time.	From DVDD33 rising to 3.3V to clock stable of 20MHz crystal oscillator.	-	-	20	ms

Note: The above typical timing data is measured from AX88179A test board.

Table 5-4: Power-up Sequence Timing Table



### 5.5 AC Timing Characteristics

#### 5.5.1 SPI Timing

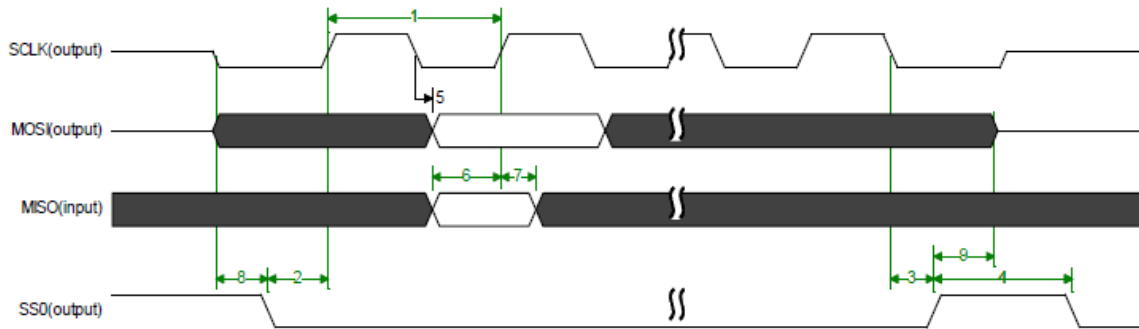

Figure 5-3: SPI Timing

Symbol	Parameter	Min	Typ	Max	Units
1	SCLK clock frequency	-	Fsys_clk (SPIBRR + 1) * 2		MHz
2	Setup time of SS to the first SCLK edge	-	0.5 * Tclk	-	ns
3	Hold time of SS after the last SCLK edge	-	0.5 * Tclk	-	ns
4	Minimum idle time between transfers (minimum SS high time)	-	((32 * SPIDT + 6) * Tsys_clk) + (0.5 * Tclk)	-	ns
5	MOSI data valid time, after SCLK edge	-		1.53	ns
6	MISO data setup time before SCLK edge	5.98		-	ns
7	MISO data hold time after SCLK edge	0		-	ns
8, 9	Bus drive time before SS assertion and after SS de-assertion	-		0.5 * Tclk	ns

Note 1: Fclk = 1/Tclk, where Tclk = ((SCL\_HP + SCL\_LP) \* Tsys\_clk).  
Tsys\_clk is 20MHz or 80MHz.

Table 5-5: SPI Timing Table



**5.5.2 Clock Timing**

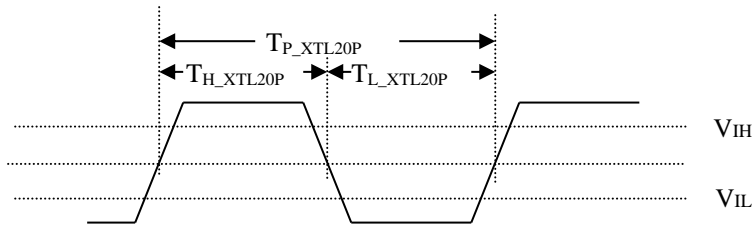
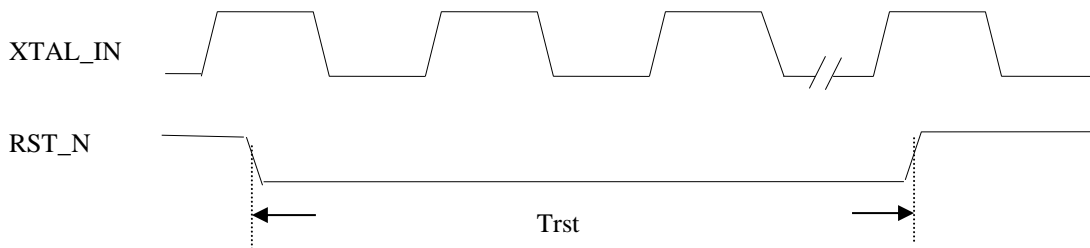

Figure 5-4: Clock Timing Diagram

Symbol	Parameter	Condition	Min	Typ	Max	Unit
$T_{P\_XTL20P}$	XTL20P clock cycle time		-	50.0	-	ns
$T_{H\_XTL20P}$	XTL20P clock high time		-	25.0	-	ns
$T_{L\_XTL20P}$	XTL20P clock low time		-	25.0	-	ns

Table 5-6: Clock Timing Table

**5.5.3 Reset Timing**



Symbol	Description	Min	Typ	Max	Unit
Trst	Reset pulse width after XTAL_IN is running	200	-	-	XTAL_IN clock cycle

Table 5-7: Reset Timing Table



## 6 Package Information

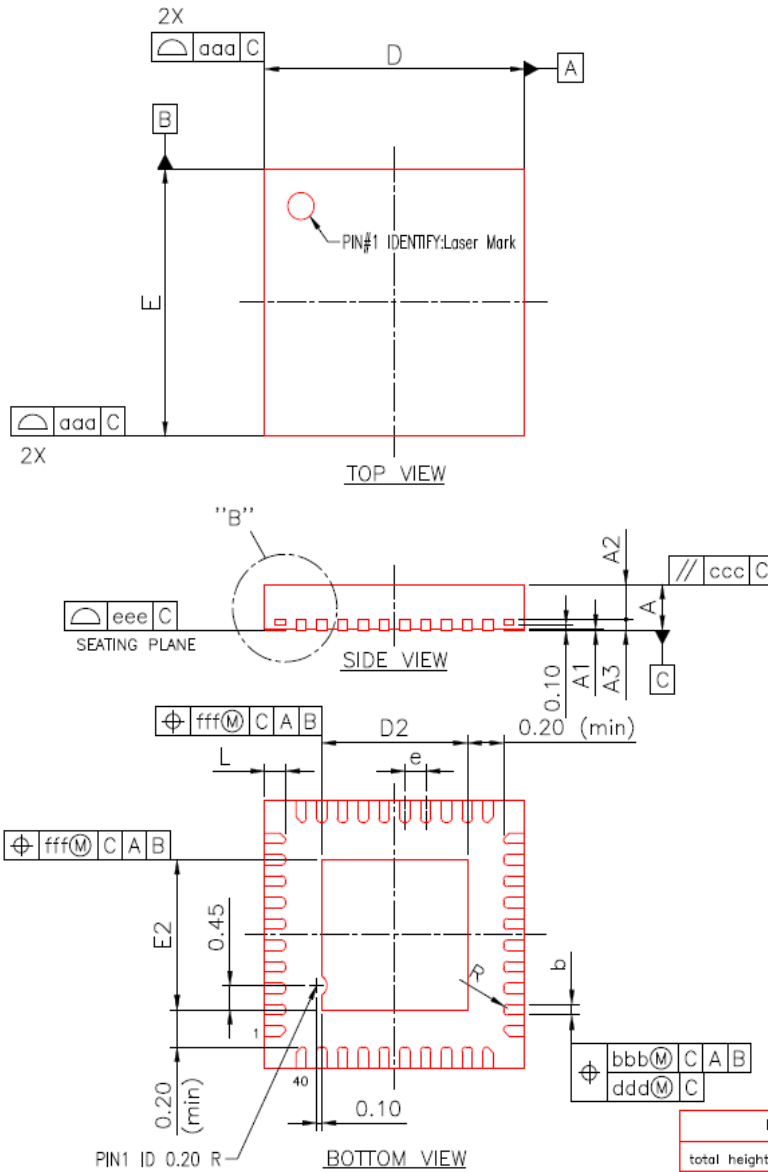

Item	Symbol	MIN.	NOM.	MAX.
total height	A	0.80	0.85	0.90
stand off	A1	0.00	0.02	0.05
mold thickness	A2	0.60	0.65	0.70
leadframe thickness	A3	0.20 REF.		
lead width	b	0.15	0.20	0.25
package size	X D	4.90	5.00	5.10
	Y E	4.90	5.00	5.10
E-PAD size	X D2	2.70	2.80	2.90
	Y E2	2.70	2.80	2.90
lead length	L	0.30	0.40	0.50
lead pitch	e	0.40 bsc		
lead arc	R	0.075	---	---
Package profile of a surface	aaa	0.10		
Lead position	bbb	0.07		
Parallelism	ccc	0.10		
Lead position	ddd	0.05		
Lead profile of a surface	eee	0.08		
Epad position	fff	0.10		



## 7 Ordering Information

Part Number	Description
AX88179AQF	40-pin QFN lead Free package, Commercial temperature range: 0 to 70°C.

## 8 Revision History

Revision	Date	Comments
V0.10	2020/10/13	Preliminary release.
V0.20	2020/10/21	1.Modified some descriptions in Section 1.4, 3.1, 4.3. 2.Updated the package information in Section 6. 3.Updated the part number information in Section 7.
V0.30	2021/01/08	Updated Wake-on-LAN Functions in Features page
V0.40	2021/01/26	Corrected USB Device Controller Functions in Features page
V0.50	2021/06/16	1.Modified some descriptions in Section 1.4.4 2.Updated Table 5-2.
V1.00	2021/06/25	Updated some description in Section 1.4.4
V1.01	2021/12/06	Updated some description in Section 5.1.1
V1.02	2021/12/21	Updated some description in Features page.



**ASIX** Electronics Corporation.

4F, No. 8, Hsin Ann Rd., HsinChu Science Park,  
HsinChu, Taiwan, R.O.C.

TEL: 886-3-5799500

FAX: 886-3-5799558

Email: [support@asix.com.tw](mailto:support@asix.com.tw)

Web: <http://www.asix.com.tw>

www.boccn.com.cn 010-51581140/51663110