

## Synchronous Buck NexFET™ Power Block

### FEATURES

- Half-Bridge Power Block
- 91% system Efficiency at 25A
- Up To 50A Operation
- High Frequency Operation (Up To 1.5MHz)
- High Density – SON 5-mm x 6-mm Footprint
- Optimized for 5V Gate Drive
- Low Switching Losses
- Ultra Low Inductance Package
- RoHS Compliant
- Halogen Free
- Pb-Free Terminal Plating

### APPLICATIONS

- Synchronous Buck Converters
  - High Frequency Applications
  - High Current, Low Duty Cycle Applications
- Multiphase Synchronous Buck Converters
- POL DC-DC Converters
- IMVP, VRM, and VRD Applications

### DESCRIPTION

The CSD86360Q5D NexFET™ power block is an optimized design for synchronous buck applications offering high current, high efficiency, and high frequency capability in a small 5-mm x 6-mm outline. Optimized for 5V gate drive applications, this product offers a flexible solution capable of offering a high density power supply when paired with any 5V gate drive from an external controller/driver.

Top View

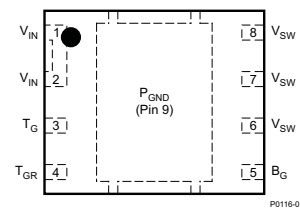

### ORDERING INFORMATION

| Device      | Package                         | Media        | Qty  | Ship          |
|-------------|---------------------------------|--------------|------|---------------|
| CSD86360Q5D | SON 5-mm x 6-mm Plastic Package | 13-Inch Reel | 2500 | Tape and Reel |

TYPICAL CIRCUIT

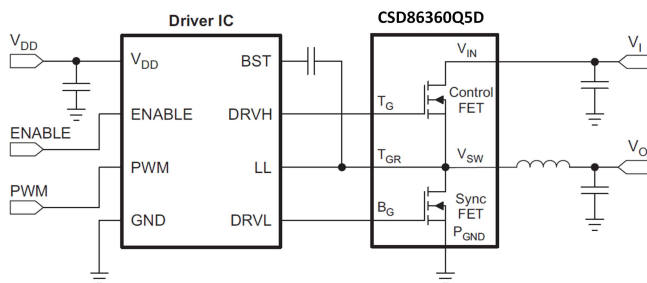

TYPICAL POWER BLOCK EFFICIENCY and POWER LOSS

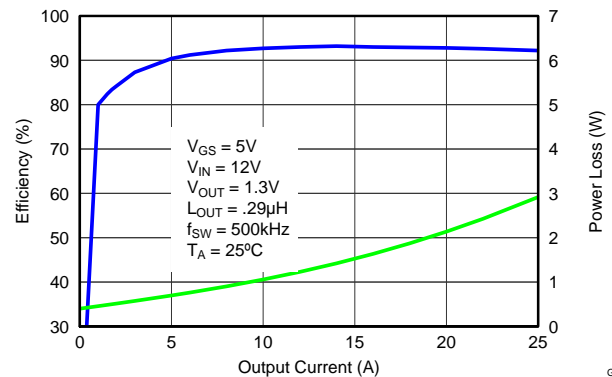

G001



Please be aware that an important notice concerning availability, standard warranty, and use in critical applications of Texas Instruments semiconductor products and disclaimers thereto appears at the end of this data sheet.

NexFET is a trademark of Texas Instruments.

PRODUCTION DATA information is current as of publication date. Products conform to specifications per the terms of the Texas Instruments standard warranty. Production processing does not necessarily include testing of all parameters.

Copyright © 2012, Texas Instruments Incorporated



These devices have limited built-in ESD protection. The leads should be shorted together or the device placed in conductive foam during storage or handling to prevent electrostatic damage to the MOS gates.

## ABSOLUTE MAXIMUM RATINGS

$T_A = 25^\circ\text{C}$  (unless otherwise noted) <sup>(1)</sup>

| Parameter   | Conditions   | VALUE |     | UNIT             |
|---|--|-------|-----|------------------|
|   |  | MIN   | MAX |                  |
| Voltage range   | $V_{IN}$ to $P_{GND}$                                |       | 25  | V                |
|   | $V_{SW}$ to $P_{GND}$                                |       | 25  |                  |
|   | $V_{SW}$ to $P_{GND}$ (10 ns)                        |       | 27  |                  |
|   | $T_G$ to $T_{GR}$                                    | -8    | 10  | V                |
|   | $B_G$ to $P_{GND}$                                   | -8    | 10  | V                |
| Pulsed Current Rating, $I_{DM}$ <sup>(2)</sup>                      |  |       | 120 | A                |
| Power Dissipation, $P_D$ <sup>(3)</sup>                             |  |       | 13  | W                |
| Avalanche Energy $E_{AS}$   | Sync FET, $I_D = 110\text{A}$ , $L = 0.1\text{mH}$   |       | 605 | mJ               |
|   | Control FET, $I_D = 61\text{A}$ , $L = 0.1\text{mH}$ |       | 186 |                  |
| Operating Junction and Storage Temperature Range, $T_J$ , $T_{STG}$ |  | -55   | 150 | $^\circ\text{C}$ |

(1) Stresses beyond those listed under Absolute Maximum Ratings may cause permanent damage to the device. These are stress ratings only, and functional operation of the device at these or any other conditions beyond those indicated is not implied. Exposure to absolute-maximum-rated conditions for extended periods may affect device reliability.

(2) Pulse Duration  $\leq 50 \mu\text{s}$ . Duty cycle  $\leq 0.01$ .

(3)  $T_{PCB} \leq 95^\circ\text{C}$ .

## RECOMMENDED OPERATING CONDITIONS

$T_A = 25^\circ$  (unless otherwise noted)

| Parameter                      | Conditions                       | MIN | MAX  | UNIT             |
|--------------------------------|----------------------------------|-----|------|------------------|
| Gate Drive Voltage, $V_{GS}$   |                                  | 4.5 | 8    | V                |
| Input Supply Voltage, $V_{IN}$ |                                  |     | 22   | V                |
| Switching Frequency, $f_{SW}$  | $C_{BST} = 0.1\mu\text{F}$ (min) | 200 | 1500 | kHz              |
| Operating Current              |                                  |     | 50   | A                |
| Operating Temperature, $T_J$   |                                  |     | 125  | $^\circ\text{C}$ |

## POWER BLOCK PERFORMANCE

$T_A = 25^\circ$  (unless otherwise noted)

| Parameter                              | Conditions  | MIN | TYP | MAX | UNIT          |
|--|---|-----|-----|-----|---------------|
| Power Loss, $P_{LOSS}$ <sup>(1)</sup>  | $V_{IN} = 12\text{V}$ , $V_{GS} = 5\text{V}$ ,<br>$V_{OUT} = 1.3\text{V}$ , $I_{OUT} = 25\text{A}$ ,<br>$f_{SW} = 500\text{kHz}$ ,<br>$L_{OUT} = 0.3\mu\text{H}$ , $T_J = 25^\circ\text{C}$ |     | 2.6 |     | W             |
| $V_{IN}$ Quiescent Current, $I_{QVIN}$ | $T_G$ to $T_{GR} = 0\text{V}$<br>$B_G$ to $P_{GND} = 0\text{V}$   |     | 10  |     | $\mu\text{A}$ |

(1) Measurement made with six  $10\mu\text{F}$  (TDK C3216X5R1C106KT or equivalent) ceramic capacitors placed across  $V_{IN}$  to  $P_{GND}$  pins and using a high current 5V driver IC.

## THERMAL INFORMATION

 $T_A = 25^\circ\text{C}$  (unless otherwise stated)

| THERMAL METRIC  |   | MIN | TYP | MAX | UNIT |
|-----------------|---|-----|-----|-----|------|
| $R_{\theta JA}$ | Junction to ambient thermal resistance (Min Cu) <sup>(1)(2)</sup>   |     |     | 102 | °C/W |
|                 | Junction to ambient thermal resistance (Max Cu) <sup>(1)(2)</sup>   |     |     | 50  |      |
| $R_{\theta JC}$ | Junction to case thermal resistance (Top of package) <sup>(2)</sup> |     |     | 20  |      |
|                 | Junction to case thermal resistance ( $P_{GND}$ Pin) <sup>(2)</sup> |     |     | 2   |      |

(1) Device mounted on FR4 material with 1-inch<sup>2</sup> (6.45-cm<sup>2</sup>) Cu.

(2)  $R_{\theta JC}$  is determined with the device mounted on a 1-inch<sup>2</sup> (6.45-cm<sup>2</sup>), 2 oz. (0.071-mm thick) Cu pad on a 1.5-inch × 1.5-inch (3.81-cm × 3.81-cm), 0.06-inch (1.52-mm) thick FR4 board.  $R_{\theta JC}$  is specified by design while  $R_{\theta JA}$  is determined by the user's board design.

## ELECTRICAL CHARACTERISTICS

T<sub>A</sub> = 25°C (unless otherwise stated)

| PARAMETER                      |   | TEST CONDITIONS  | Q1 Control FET |     |     | Q2 Sync FET |     |     | UNIT |   |
|--------------------------------|---|--|----------------|-----|-----|-------------|-----|-----|------|---|
|                                |   |  | MIN            | TYP | MAX | MIN         | TYP | MAX |      |   |
| <b>Static Characteristics</b>  |   |  |                |     |     |             |     |     |      |   |
| B <sub>V</sub> DSS             | Drain to Source Voltage                     | V <sub>GS</sub> = 0V, I <sub>DS</sub> = 250µA  | 25             |     |     | 25          |     |     | V    |   |
| I <sub>DSS</sub>               | Drain to Source Leakage Current             | V <sub>GS</sub> = 0V, V <sub>DS</sub> = 20V  | 1              |     |     | 1           |     |     | µA   |   |
| I <sub>GSS</sub>               | Gate to Source Leakage Current              | V <sub>DS</sub> = 0V, V <sub>GS</sub> = +10 / -8   | 100            |     |     | 100         |     |     | nA   |   |
| V <sub>GS(th)</sub>            | Gate to Source Threshold Voltage            | V <sub>DS</sub> = V <sub>GS</sub> , I <sub>DS</sub> = 250µA  | 1              |     |     | 0.75        |     |     | 1.15 | V |
| Z <sub>DS(on)</sub>            | Drain to Source On Impedance                | V <sub>In</sub> = 12V, V <sub>DD</sub> = 5V, V <sub>Out</sub> = 1.3V, I <sub>Out</sub> = 25A, f <sub>SW</sub> = 500kHz, L <sub>Out</sub> = 0.3µH | 3.7            |     |     | 0.7         |     |     | mΩ   |   |
| g <sub>fs</sub>                | Transconductance                            | V <sub>DS</sub> = 10V, I <sub>DS</sub> = 20A   | 113            |     |     | 169         |     |     | S    |   |
| <b>Dynamic Characteristics</b> |   |  |                |     |     |             |     |     |      |   |
| C <sub>ISS</sub>               | Input Capacitance <sup>(1)</sup>            | V <sub>GS</sub> = 0V, V <sub>DS</sub> = 12.5V, f = 1MHz  | 1590           |     |     | 2060        |     |     | pF   |   |
| C <sub>OSS</sub>               | Output Capacitance <sup>(1)</sup>           |  | 840            |     |     | 1090        |     |     |      |   |
| C <sub>RSS</sub>               | Reverse Transfer Capacitance <sup>(1)</sup> |  | 42             |     |     | 54          |     |     |      |   |
| R <sub>G</sub>                 | Series Gate Resistance <sup>(1)</sup>       |  | 1.2            |     |     | 2.5         |     |     | Ω    |   |
| Q <sub>g</sub>                 | Gate Charge Total (4.5V) <sup>(1)</sup>     | V <sub>DS</sub> = 12.5V, I <sub>DS</sub> = 20A   | 9.7            |     |     | 12.6        |     |     | nC   |   |
| Q <sub>gd</sub>                | Gate Charge - Gate to Drain                 |  | 2.3            |     |     | 3.6         |     |     |      |   |
| Q <sub>gs</sub>                | Gate Charge - Gate to Source                |  | 3.5            |     |     | 6.0         |     |     |      |   |
| Q <sub>g(th)</sub>             | Gate Charge at V <sub>th</sub>              |  | 1.9            |     |     | 3.5         |     |     |      |   |
| Q <sub>OSS</sub>               | Output Charge                               | V <sub>DS</sub> = 12.5V, V <sub>GS</sub> = 0V  | 15.1           |     |     | 33          |     |     | nC   |   |
| t <sub>d(on)</sub>             | Turn On Delay Time                          | V <sub>DS</sub> = 12.5V, V <sub>GS</sub> = 4.5V, I <sub>DS</sub> = 20A, R <sub>G</sub> = 2Ω  | 8.4            |     |     | 9.5         |     |     | ns   |   |
| t <sub>r</sub>                 | Rise Time                                   |  | 20.4           |     |     | 14.8        |     |     |      |   |
| t <sub>d(off)</sub>            | Turn Off Delay Time                         |  | 14.5           |     |     | 29.3        |     |     |      |   |
| t <sub>f</sub>                 | Fall Time                                   |  | 4.3            |     |     | 6.6         |     |     |      |   |
| <b>Diode Characteristics</b>   |   |  |                |     |     |             |     |     |      |   |
| V <sub>SD</sub>                | Diode Forward Voltage                       | I <sub>DS</sub> = 20A, V <sub>GS</sub> = 0V  | 0.85           |     |     | 1           |     |     | V    |   |
| Q <sub>rr</sub>                | Reverse Recovery Charge                     | V <sub>dd</sub> = 12V, I <sub>F</sub> = 20A,   | 27             |     |     | 50          |     |     |      |   |
| t <sub>rr</sub>                | Reverse Recovery Time                       | di/dt = 300A/µs  | 22             |     |     | 34          |     |     |      |   |

(1) Specified by design

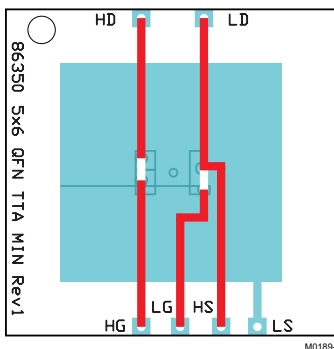

M0189-01

Max R<sub>θJA</sub> = 50°C/W when mounted on 1 inch<sup>2</sup> (6.45 cm<sup>2</sup>) of 2-oz. (0.071-mm thick) Cu.

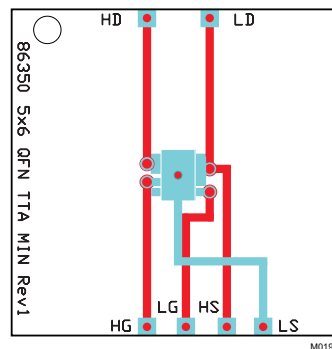

M0190-01

Max R<sub>θJA</sub> = 102°C/W when mounted on minimum pad area of 2-oz. (0.071-mm thick) Cu.

## TYPICAL POWER BLOCK DEVICE CHARACTERISTICS

$T_J = 125^\circ\text{C}$ , unless stated otherwise.

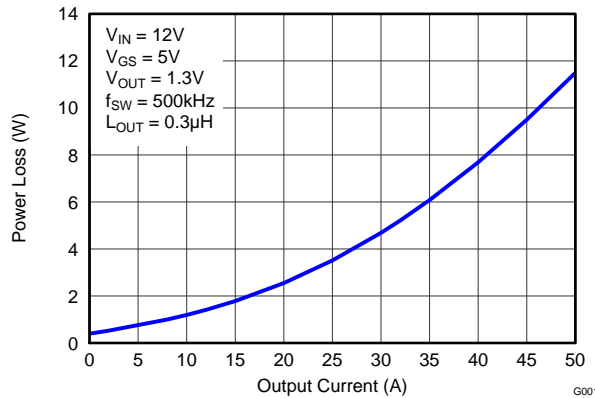

Figure 1. Power Loss vs Output Current

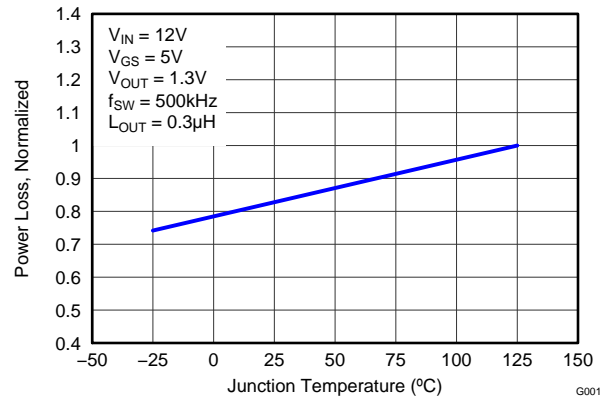

Figure 2. Normalized Power Loss vs Temperature

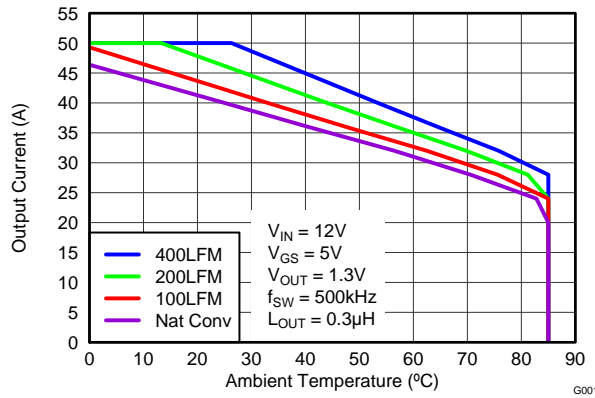

Figure 3. Safe Operating Area – PCB Vertical Mount <sup>(1)</sup>

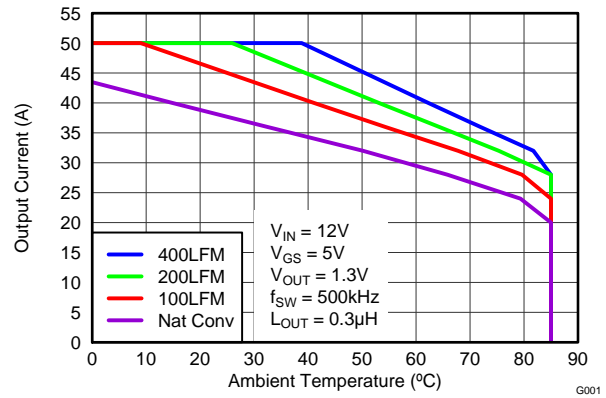

Figure 4. Safe Operating Area – PCB Horizontal Mount <sup>(1)</sup>

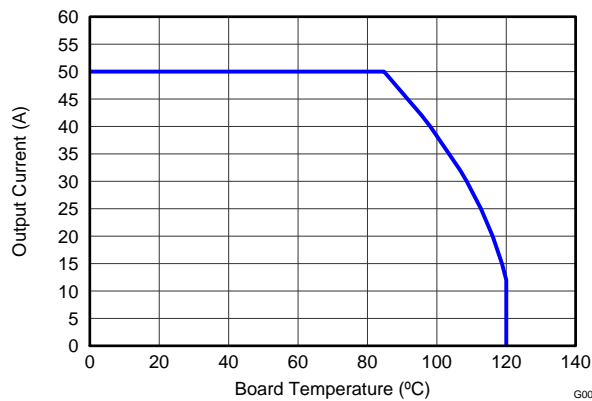
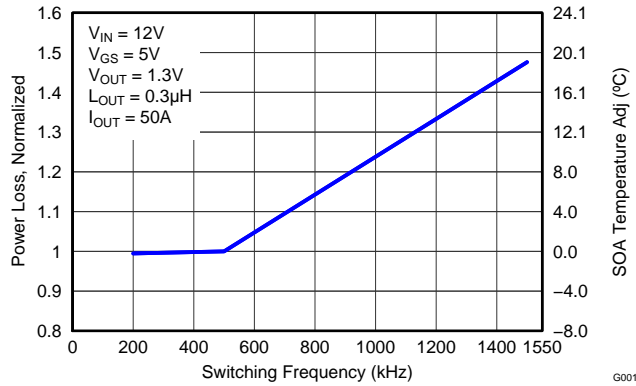

Figure 5. Typical Safe Operating Area<sup>(1)</sup>

(1) The Typical Power Block System Characteristic curves are based on measurements made on a PCB design with dimensions of 4.0" (W) x 3.5" (L) x 0.062" (H) and 6 copper layers of 1 oz. copper thickness. See Application Section for detailed explanation.

**TYPICAL POWER BLOCK DEVICE CHARACTERISTICS (continued)**

T<sub>J</sub> = 125°C, unless stated otherwise.



**Figure 6. Normalized Power Loss vs Switching Frequency**

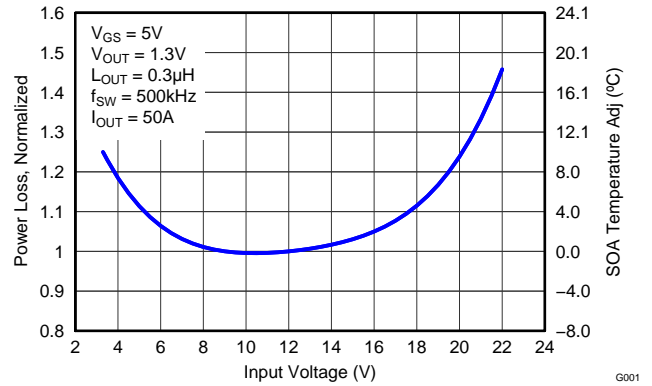

**Figure 7. Normalized Power Loss vs Input Voltage**

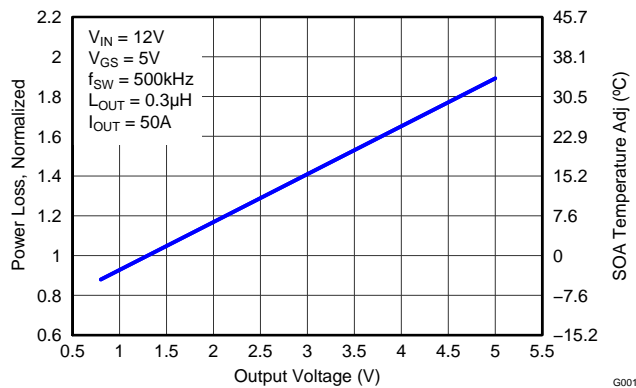

**Figure 8. Normalized Power Loss vs. Output Voltage**

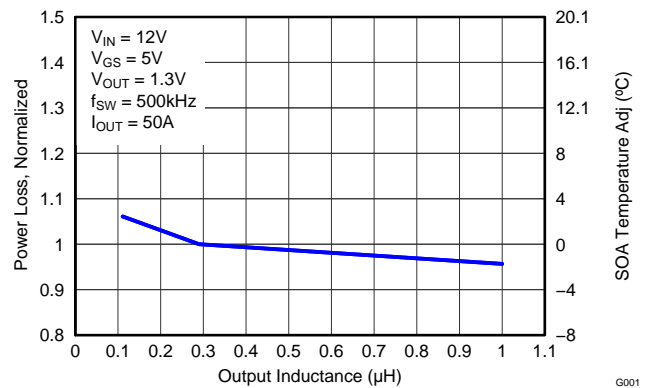

**Figure 9. Normalized Power Loss vs. Output Inductance**

### TYPICAL POWER BLOCK MOSFET CHARACTERISTICS

$T_A = 25^\circ\text{C}$ , unless stated otherwise.

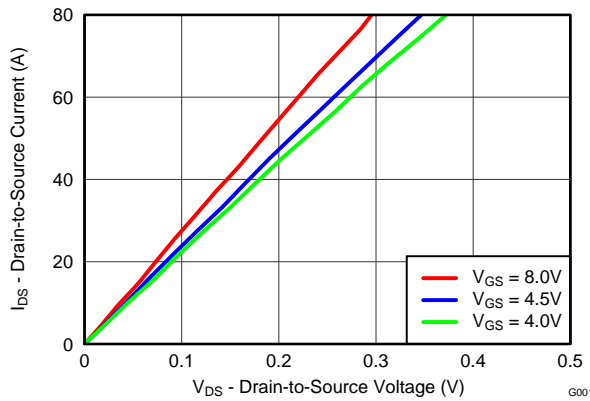

Figure 10. Control MOSFET Saturation

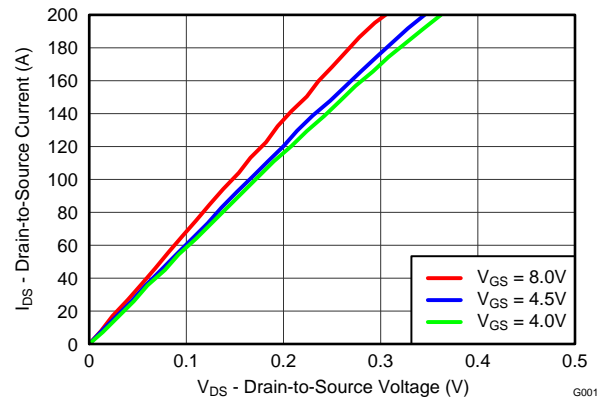

Figure 11. Sync MOSFET Saturation

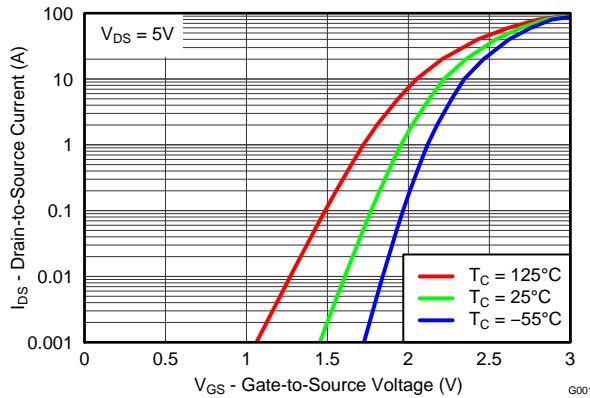

Figure 12. Control MOSFET Transfer

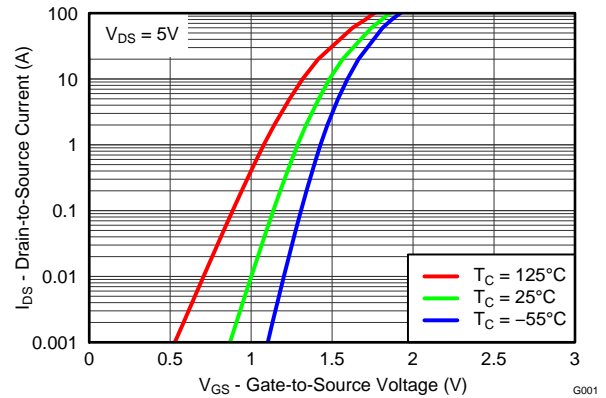

Figure 13. Sync MOSFET Transfer

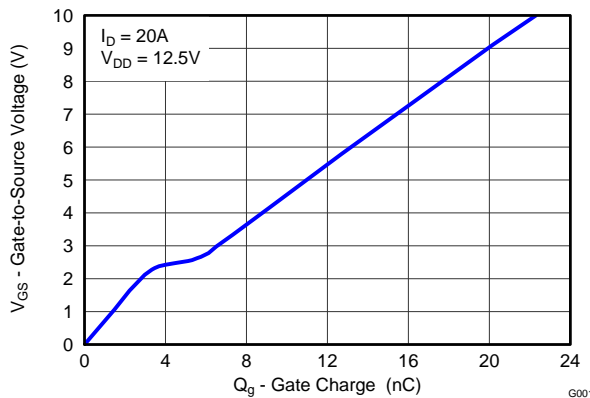

Figure 14. Control MOSFET Gate Charge

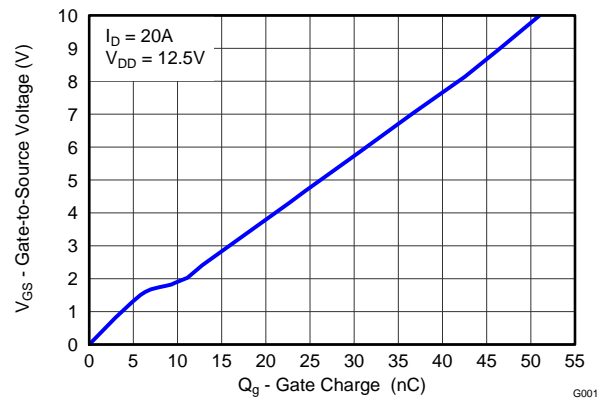
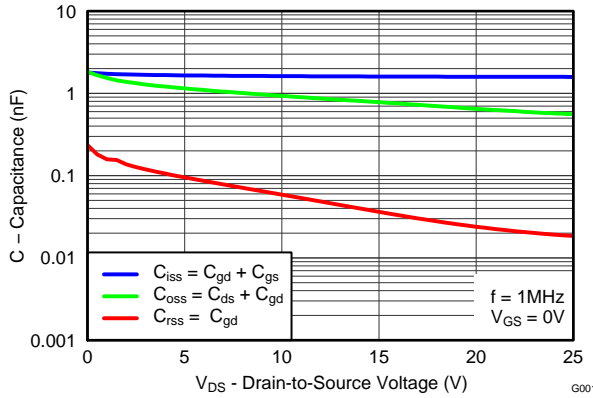

Figure 15. Sync MOSFET Gate Charge

**TYPICAL POWER BLOCK MOSFET CHARACTERISTICS (continued)**

T<sub>A</sub> = 25°C, unless stated otherwise.



**Figure 16. Control MOSFET Capacitance**

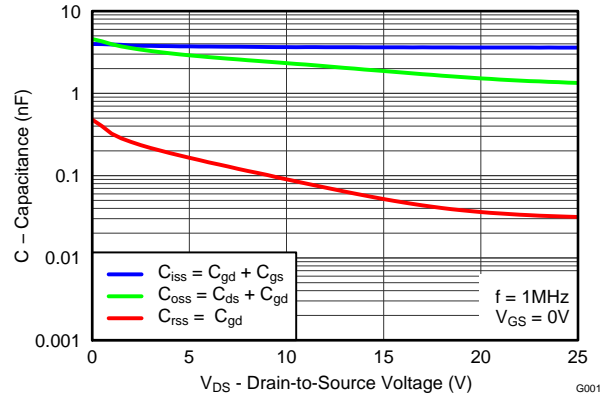

**Figure 17. Sync MOSFET Capacitance**

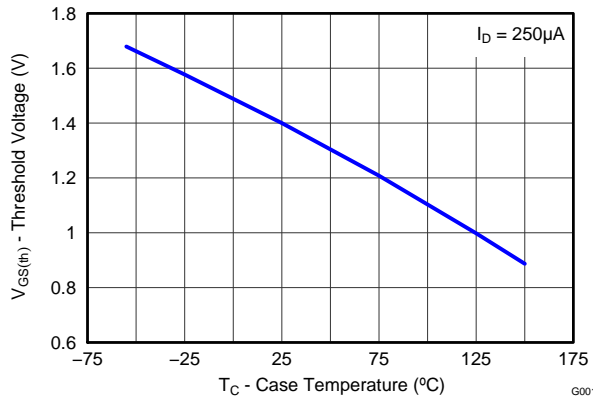

**Figure 18. Control MOSFET V<sub>GS(th)</sub>**

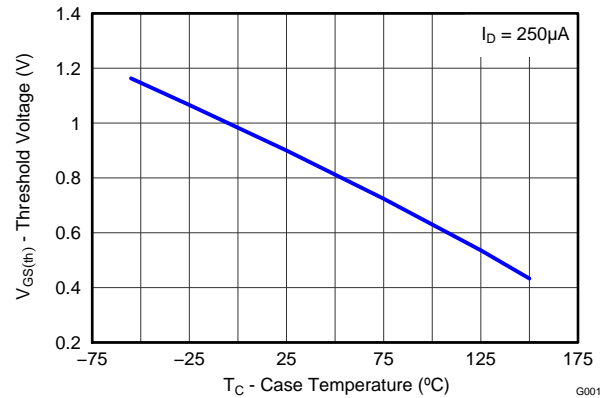

**Figure 19. Sync MOSFET V<sub>GS(th)</sub>**

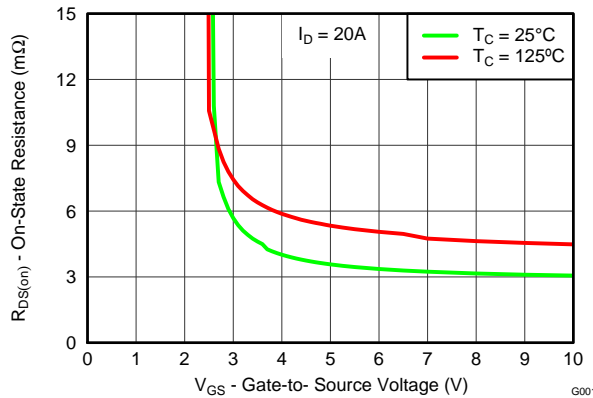

**Figure 20. Control MOSFET R<sub>DS(on)</sub> vs V<sub>GS</sub>**

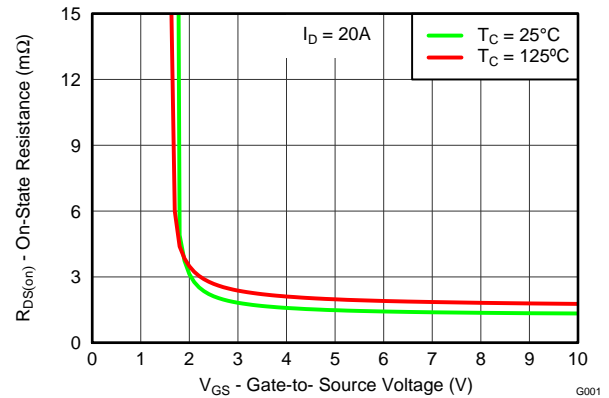
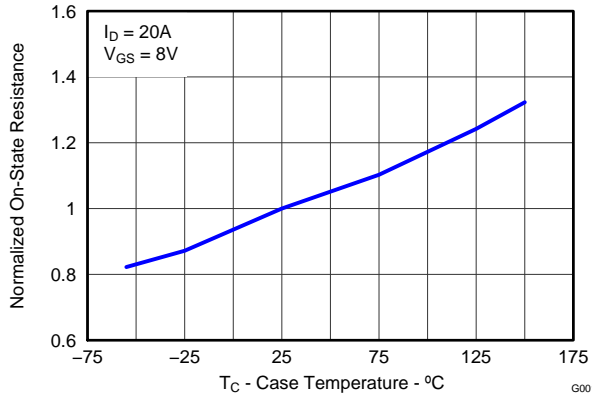

**Figure 21. Sync MOSFET R<sub>DS(on)</sub> vs V<sub>GS</sub>**



**TYPICAL POWER BLOCK MOSFET CHARACTERISTICS (continued)**

$T_A = 25^\circ\text{C}$ , unless stated otherwise.



**Figure 22. Control MOSFET Normalized  $R_{DS(on)}$**

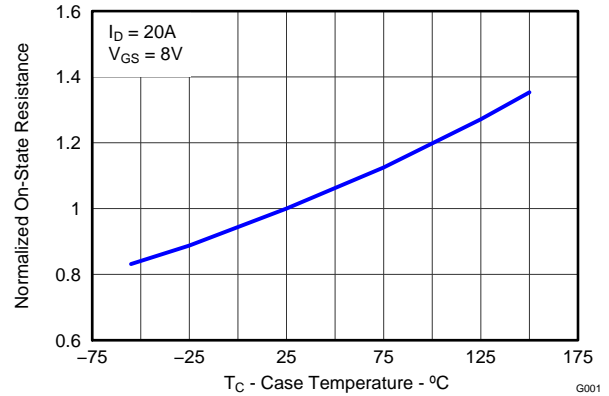

**Figure 23. Sync MOSFET Normalized  $R_{DS(on)}$**

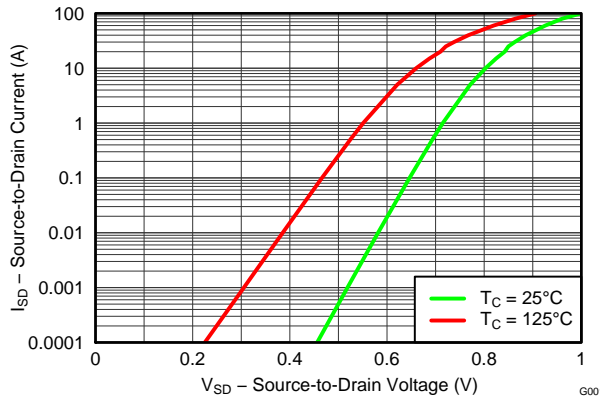

**Figure 24. Control MOSFET Body Diode**

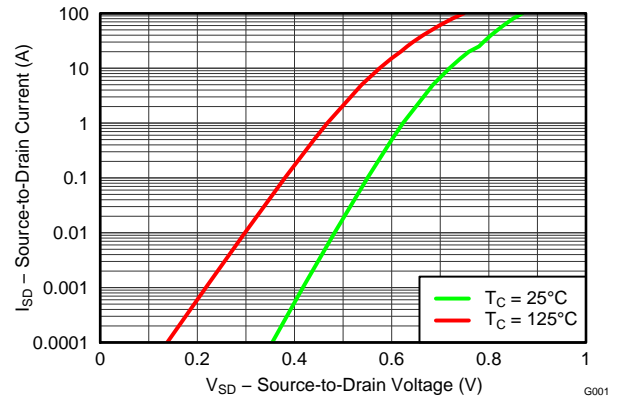

**Figure 25. Sync MOSFET Body Diode**

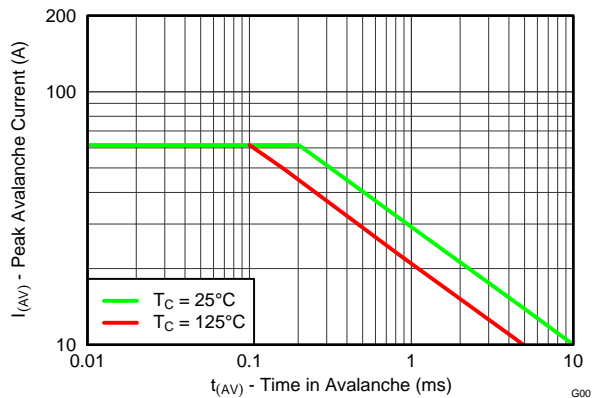

**Figure 26. Control MOSFET Unclamped Inductive Switching**

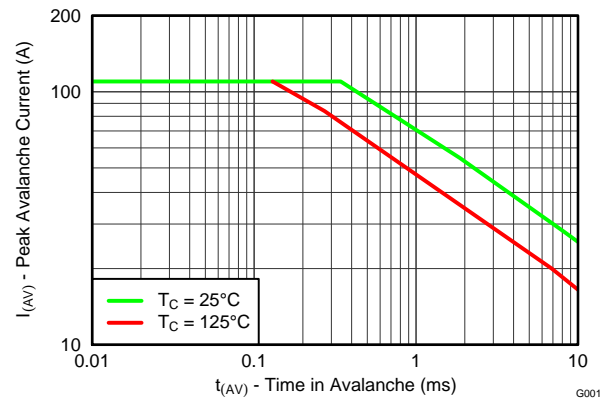
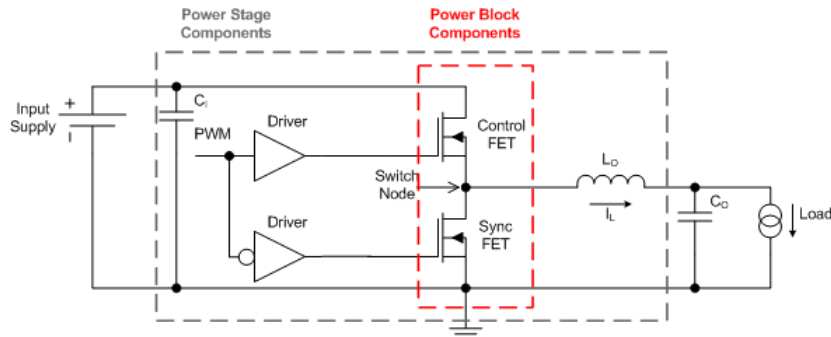

**Figure 27. Sync MOSFET Unclamped Inductive Switching**

## APPLICATION INFORMATION

### Equivalent System Performance

Many of today's high performance computing systems require low power consumption in an effort to reduce system operating temperatures and improve overall system efficiency. This has created a major emphasis on improving the conversion efficiency of today's Synchronous Buck Topology. In particular, there has been an emphasis in improving the performance of the critical Power Semiconductor in the Power Stage of this Application (see [Figure 28](#)). As such, optimization of the power semiconductors in these applications, needs to go beyond simply reducing  $R_{DS(ON)}$ .



**Figure 28.**

The CSD86360Q5D is part of TI's Power Block product family which is a highly optimized product for use in a synchronous buck topology requiring high current, high efficiency, and high frequency. It incorporates TI's latest generation silicon which has been optimized for switching performance, as well as minimizing losses associated with  $Q_{GD}$ ,  $Q_{GS}$ , and  $Q_{RR}$ . Furthermore, TI's patented packaging technology has minimized losses by nearly eliminating parasitic elements between the Control FET and Sync FET connections (see [Figure 29](#)). A key challenge solved by TI's patented packaging technology is the system level impact of Common Source Inductance (CSI). CSI greatly impedes the switching characteristics of any MOSFET which in turn increases switching losses and reduces system efficiency. As a result, the effects of CSI need to be considered during the MOSFET selection process. In addition, standard MOSFET switching loss equations used to predict system efficiency need to be modified in order to account for the effects of CSI. Further details behind the effects of CSI and modification of switching loss equations are outlined in TI's Application Note [SLPA009](#).

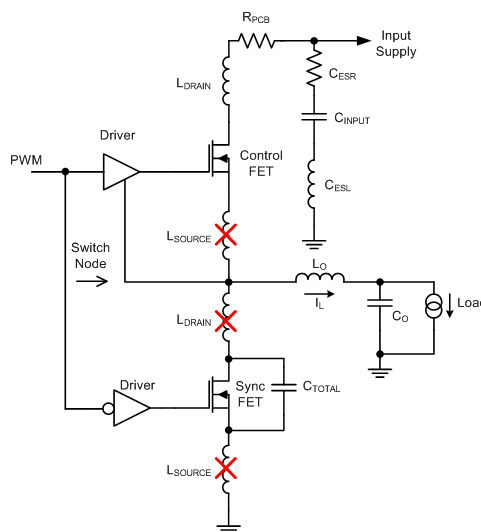

**Figure 29.**

The combination of TI's latest generation silicon and optimized packaging technology has created a benchmarking solution that outperforms industry standard MOSFET chipsets of similar  $R_{DS(ON)}$  and MOSFET chipsets with lower  $R_{DS(ON)}$ . Figure 30 and Figure 31 compare the efficiency and power loss performance of the CSD86360Q5D versus industry standard MOSFET chipsets commonly used in this type of application. This comparison purely focuses on the efficiency and generated loss of the power semiconductors only. The performance of CSD86360Q5D clearly highlights the importance of considering the Effective AC On-Impedance ( $Z_{DS(ON)}$ ) during the MOSFET selection process of any new design. Simply normalizing to traditional MOSFET  $R_{DS(ON)}$  specifications is not an indicator of the actual in-circuit performance when using TI's Power Block technology.

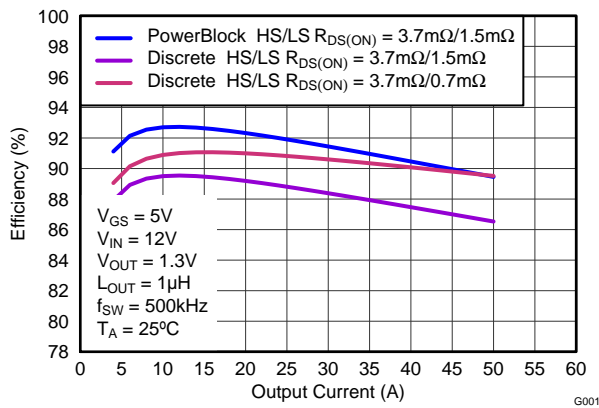

Figure 30. Efficiency Comparison for Discrete Parts vs. Power Block

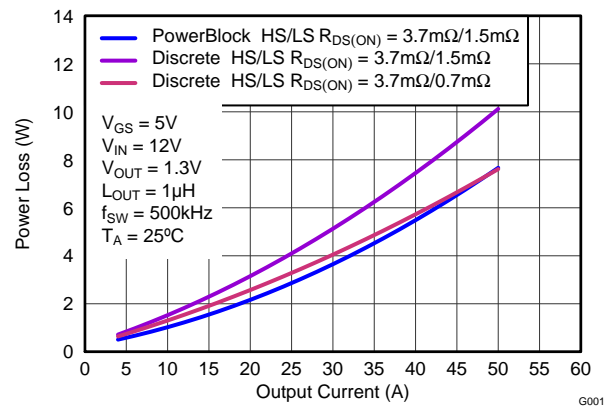

Figure 31. Power Loss Comparison for Discrete Parts vs. Power Block

The chart below compares the traditional DC measured  $R_{DS(ON)}$  of CSD86360Q5D versus its  $Z_{DS(ON)}$ . This comparison takes into account the improved efficiency associated with TI's patented packaging technology. As such, when comparing TI's Power Block products to individually packaged discrete MOSFETs or dual MOSFETs in a standard package, the in-circuit switching performance of the solution must be considered. In this example, individually packaged discrete MOSFETs or dual MOSFETs in a standard package would need to have DC measured  $R_{DS(ON)}$  values that are equivalent to CSD86360Q5D's  $Z_{DS(ON)}$  value in order to have the same efficiency performance at full load. Mid to light-load efficiency will still be lower with individually packaged discrete MOSFETs or dual MOSFETs in a standard package.

Comparison of  $R_{DS(ON)}$  vs.  $Z_{DS(ON)}$

| Parameter  | HS  |     | LS  |     |
|--|-----|-----|-----|-----|
|  | Typ | Max | Typ | Max |
| Effective AC On-Impedance $Z_{DS(ON)}$ ( $V_{GS} = 5V$ ) | 3.7 | -   | 0.7 | -   |
| DC Measured $R_{DS(ON)}$ ( $V_{GS} = 4.5V$ )             | 3.7 | 4.5 | 1.5 | 1.9 |

The CSD86360Q5D NexFET™ power block is an optimized design for synchronous buck applications using 5V gate drive. The Control FET and Sync FET silicon are parametrically tuned to yield the lowest power loss and highest system efficiency. As a result, a new rating method is needed which is tailored towards a more systems centric environment. System level performance curves such as Power Loss, Safe Operating Area, and normalized graphs allow engineers to predict the product performance in the actual application.

## Power Loss Curves

MOSFET centric parameters such as  $R_{DS(ON)}$  and  $Q_{gd}$  are needed to estimate the loss generated by the devices. In an effort to simplify the design process for engineers, Texas Instruments has provided measured power loss performance curves. [Figure 1](#) plots the power loss of the CSD86360Q5D as a function of load current. This curve is measured by configuring and running the CSD86360Q5D as it would be in the final application (see [Figure 32](#)). The measured power loss is the CSD86360Q5D loss and consists of both input conversion loss and gate drive loss. [Equation 1](#) is used to generate the power loss curve.

$$(V_{IN} \times I_{IN}) + (V_{DD} \times I_{DD}) - (V_{SW\_AVG} \times I_{OUT}) = \text{Power Loss} \quad (1)$$

The power loss curve in [Figure 1](#) is measured at the maximum recommended junction temperatures of 125°C under isothermal test conditions.

## Safe Operating Curves (SOA)

The SOA curves in the CSD86360Q5D data sheet provides guidance on the temperature boundaries within an operating system by incorporating the thermal resistance and system power loss. [Figure 3](#) to [Figure 5](#) outline the temperature and airflow conditions required for a given load current. The area under the curve dictates the safe operating area. All the curves are based on measurements made on a PCB design with dimensions of 4" (W) x 3.5" (L) x 0.062" (T) and 6 copper layers of 1 oz. copper thickness.

## Normalized Curves

The normalized curves in the CSD86360Q5D data sheet provides guidance on the Power Loss and SOA adjustments based on their application specific needs. These curves show how the power loss and SOA boundaries will adjust for a given set of systems conditions. The primary Y-axis is the normalized change in power loss and the secondary Y-axis is the change in system temperature required in order to comply with the SOA curve. The change in power loss is a multiplier for the Power Loss curve and the change in temperature is subtracted from the SOA curve.

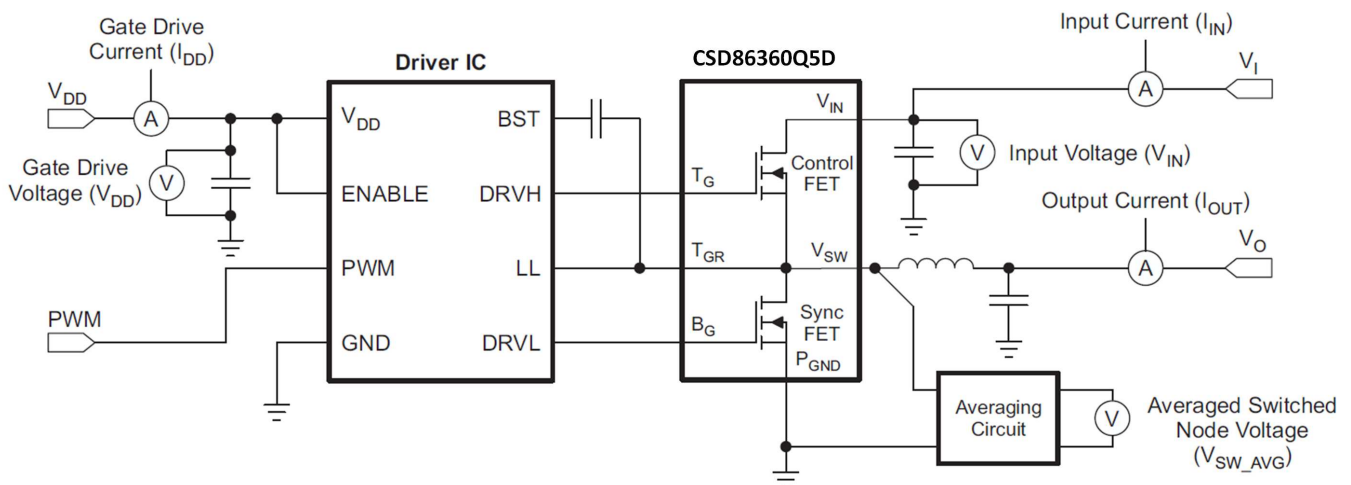

**Figure 32. Typical Application**

## Calculating Power Loss and SOA

The user can estimate product loss and SOA boundaries by arithmetic means (see Design Example). Though the Power Loss and SOA curves in this data sheet are taken for a specific set of test conditions, the following procedure will outline the steps the user should take to predict product performance for any set of system conditions.

### Design Example

Operating Conditions:

- Output Current = 25A
- Input Voltage = 7V
- Output Voltage = 1V
- Switching Frequency = 800kHz
- Inductor = 0.2μH

### Calculating Power Loss

- Power Loss at 25A = 3.5W (Figure 1)
- Normalized Power Loss for input voltage  $\approx 1.03$  (Figure 7)
- Normalized Power Loss for output voltage  $\approx 0.90$  (Figure 8)
- Normalized Power Loss for switching frequency  $\approx 1.15$  (Figure 6)
- Normalized Power Loss for output inductor  $\approx 1.03$  (Figure 9)
- **Final calculated Power Loss = 3.5W x 1.03 x 0.90 x 1.15 x 1.03  $\approx 3.84$ W**

### Calculating SOA Adjustments

- SOA adjustment for input voltage  $\approx 1.3^{\circ}\text{C}$  (Figure 7)
- SOA adjustment for output voltage  $\approx -2.5^{\circ}\text{C}$  (Figure 8)
- SOA adjustment for switching frequency  $\approx 6.0^{\circ}\text{C}$  (Figure 6)
- SOA adjustment for output inductor  $\approx 1.3^{\circ}\text{C}$  (Figure 9)
- **Final calculated SOA adjustment = 1.3 + (-2.5) + 6.0 + 1.3  $\approx 6.1^{\circ}\text{C}$**

In the design example above, the estimated power loss of the CSD86360Q5D would increase to 3.84W. In addition, the maximum allowable board and/or ambient temperature would have to decrease by 6.1°C. Figure 33 graphically shows how the SOA curve would be adjusted accordingly.

1. Start by drawing a horizontal line from the application current to the SOA curve.
2. Draw a vertical line from the SOA curve intercept down to the board/ambient temperature.
3. Adjust the SOA board/ambient temperature by subtracting the temperature adjustment value.

In the design example, the SOA temperature adjustment yields a reduction in allowable board/ambient temperature of 6.1°C. In the event the adjustment value is a negative number, subtracting the negative number would yield an increase in allowable board/ambient temperature.

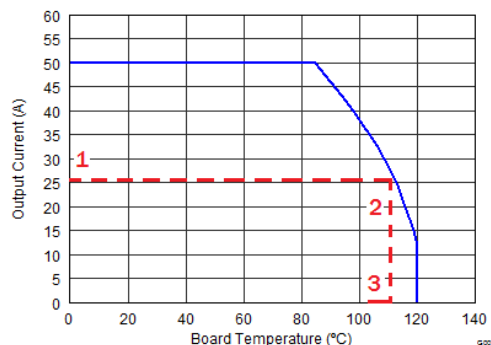

Figure 33. Power Block SOA

## RECOMMENDED PCB DESIGN OVERVIEW

There are two key system-level parameters that can be addressed with a proper PCB design: Electrical and Thermal performance. Properly optimizing the PCB layout will yield maximum performance in both areas. A brief description on how to address each parameter is provided.

### Electrical Performance

The Power Block has the ability to switch voltages at rates greater than 10kV/ $\mu$ s. Special care must be then taken with the PCB layout design and placement of the input capacitors, Driver IC, and output inductor.

- The placement of the input capacitors relative to the Power Block's VIN and PGND pins should have the highest priority during the component placement routine. It is critical to minimize these node lengths. As such, ceramic input capacitors need to be placed as close as possible to the VIN and PGND pins (see [Figure 34](#)). The example in [Figure 34](#) uses 6x10 $\mu$ F ceramic capacitors (TDK Part # C3216X5R1C106KT or equivalent). Notice there are ceramic capacitors on both sides of the board with an appropriate amount of vias interconnecting both layers. In terms of priority of placement next to the Power Block, C5, C7, C19, and C8 should follow in order.
  - The Driver IC should be placed relatively close to the Power Block Gate pins. T<sub>G</sub> and B<sub>G</sub> should connect to the outputs of the Driver IC. The T<sub>GR</sub> pin serves as the return path of the high-side gate drive circuitry and should be connected to the Phase pin of the IC (sometimes called LX, LL, SW, PH, etc.). The bootstrap capacitor for the Driver IC will also connect to this pin.
  - The switching node of the output inductor should be placed relatively close to the Power Block VSW pins. Minimizing the node length between these two components will reduce the PCB conduction losses and actually reduce the switching noise level. In the event the switch node waveform exhibits ringing that reaches undesirable levels, the use of a Boost Resistor or RC snubber can be an effective way to easily reduce the peak ring level. The recommended Boost Resistor value will range between 1.0 Ohms to 4.7 Ohms depending on the output characteristics of Driver IC used in conjunction with the Power Block. The RC snubber values can range from 0.5 Ohms to 2.2 Ohms for the R and 330pF to 2200pF for the C. Please refer to TI App Note [SLUP100](#) for more details on how to properly tune the RC snubber values. The RC snubber should be placed as close as possible to the Vsw node and PGND see [Figure 34](#) <sup>(1)</sup>
- (1) Keong W. Kam, David Pommerenke, "EMI Analysis Methods for Synchronous Buck Converter EMI Root Cause Analysis", University of Missouri – Rolla

## Thermal Performance

The Power Block has the ability to utilize the GND planes as the primary thermal path. As such, the use of thermal vias is an effective way to pull away heat from the device and into the system board. Concerns of solder voids and manufacturability problems can be addressed by the use of three basic tactics to minimize the amount of solder attach that will wick down the via barrel:

- Intentionally space out the vias from each other to avoid a cluster of holes in a given area.
- Use the smallest drill size allowed in your design. The example in [Figure 34](#) uses vias with a 10 mil drill hole and a 16 mil capture pad.
- Tent the opposite side of the via with solder-mask.

In the end, the number and drill size of the thermal vias should align with the end user's PCB design rules and manufacturing capabilities.

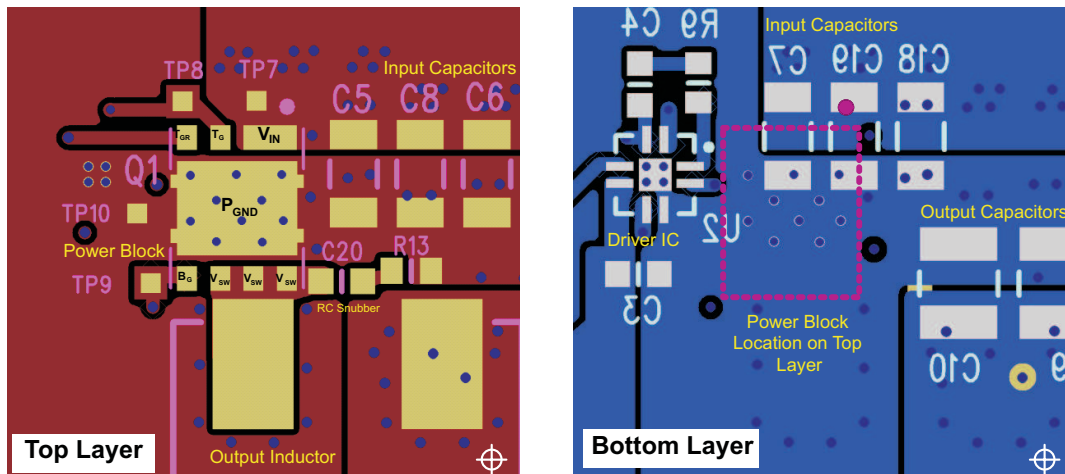
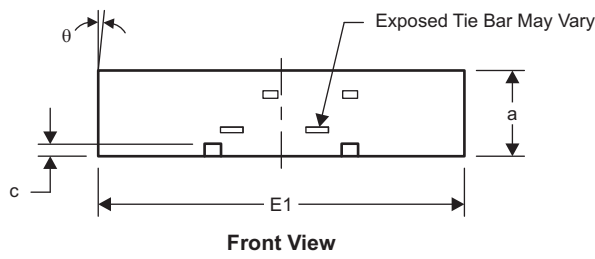
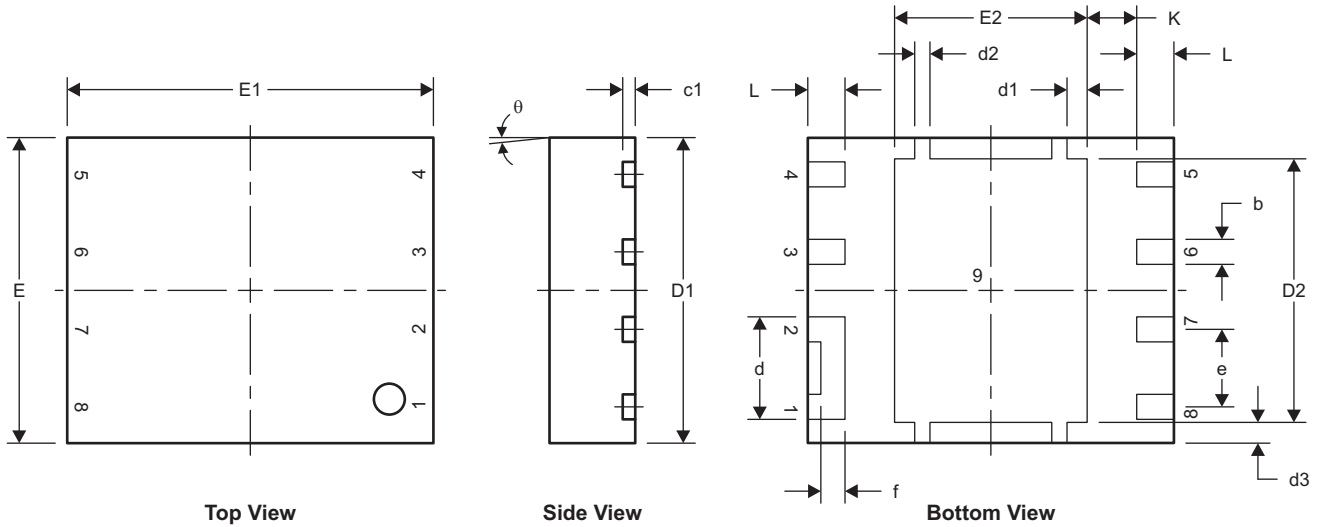

Figure 34. Recommended PCB Layout (Top Down View)

**MECHANICAL DATA**

**Q5D Package Dimensions**



| Pinout   |                  |
|----------|------------------|
| Position | Designation      |
| Pin 1    | V <sub>IN</sub>  |
| Pin 2    | V <sub>IN</sub>  |
| Pin 3    | T <sub>G</sub>   |
| Pin 4    | T <sub>GR</sub>  |
| Pin 5    | B <sub>G</sub>   |
| Pin 6    | V <sub>SW</sub>  |
| Pin 7    | V <sub>SW</sub>  |
| Pin 8    | V <sub>SW</sub>  |
| Pin 9    | P <sub>GND</sub> |

M0187-01

| DIM   | MILLIMETERS |       | INCHES |       |
|-------|-------------|-------|--------|-------|
|       | MIN         | MAX   | MIN    | MAX   |
| a     | 1.40        | 1.5   | 0.055  | 0.059 |
| b     | 0.360       | 0.460 | 0.014  | 0.018 |
| c     | 0.150       | 0.250 | 0.006  | 0.010 |
| c1    | 0.150       | 0.250 | 0.006  | 0.010 |
| d     | 1.630       | 1.730 | 0.064  | 0.068 |
| d1    | 0.280       | 0.380 | 0.011  | 0.015 |
| d2    | 0.200       | 0.300 | 0.008  | 0.012 |
| d3    | 0.291       | 0.391 | 0.012  | 0.015 |
| D1    | 4.900       | 5.100 | 0.193  | 0.201 |
| D2    | 4.269       | 4.369 | 0.168  | 0.172 |
| E     | 4.900       | 5.100 | 0.193  | 0.201 |
| E1    | 5.900       | 6.100 | 0.232  | 0.240 |
| E2    | 3.106       | 3.206 | 0.122  | 0.126 |
| e     | 1.27 TYP    |       | 0.050  |       |
| f     | 0.396       | 0.496 | 0.016  | 0.020 |
| L     | 0.510       | 0.710 | 0.020  | 0.028 |
| theta | 0.00        | -     | -      | -     |
| K     | 0.812       |       | 0.032  |       |





**Q5D Tape and Reel Information**

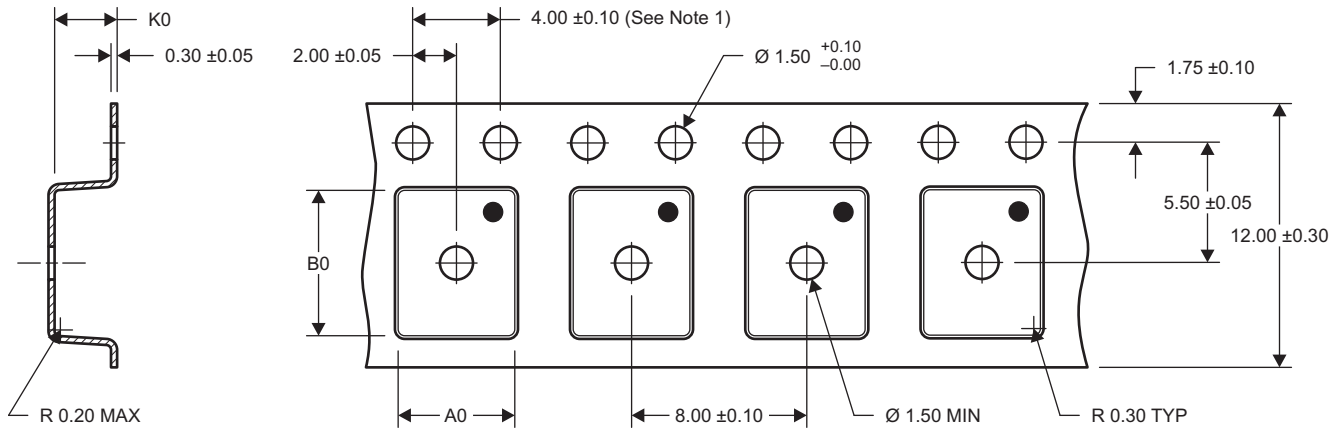

A0 = 5.30 ±0.10  
 B0 = 6.50 ±0.10  
 K0 = 1.90 ±0.10

M0191-01

- NOTES: 1. 10-sprocket hole-pitch cumulative tolerance ±0.2  
 2. Camber not to exceed 1mm in 100mm, noncumulative over 250mm  
 3. Material: black static-dissipative polystyrene  
 4. All dimensions are in mm, unless otherwise specified.  
 5. Thickness: 0.30 ±0.05mm  
 6. MSL1 260°C (IR and convection) PbF reflow compatible

**PACKAGING INFORMATION**

| Orderable Device | Status <sup>(1)</sup> | Package Type | Package Drawing | Pins | Package Qty | Eco Plan <sup>(2)</sup> | Lead/<br>Ball Finish | MSL Peak Temp <sup>(3)</sup> | Samples<br>(Requires Login) |
|------------------|-----------------------|--------------|-----------------|------|-------------|-------------------------|----------------------|------------------------------|-----------------------------|
| CSD86360Q5D      | ACTIVE                | SON          | DQY             | 8    | 2500        | Pb-Free (RoHS Exempt)   | CU NIPDAU            | Level-1-260C-UNLIM           |                             |

<sup>(1)</sup> The marketing status values are defined as follows:

**ACTIVE:** Product device recommended for new designs.

**LIFEBUY:** TI has announced that the device will be discontinued, and a lifetime-buy period is in effect.

**NRND:** Not recommended for new designs. Device is in production to support existing customers, but TI does not recommend using this part in a new design.

**PREVIEW:** Device has been announced but is not in production. Samples may or may not be available.

**OBSOLETE:** TI has discontinued the production of the device.

<sup>(2)</sup> Eco Plan - The planned eco-friendly classification: Pb-Free (RoHS), Pb-Free (RoHS Exempt), or Green (RoHS & no Sb/Br) - please check <http://www.ti.com/productcontent> for the latest availability information and additional product content details.

**TBD:** The Pb-Free/Green conversion plan has not been defined.

**Pb-Free (RoHS):** TI's terms "Lead-Free" or "Pb-Free" mean semiconductor products that are compatible with the current RoHS requirements for all 6 substances, including the requirement that lead not exceed 0.1% by weight in homogeneous materials. Where designed to be soldered at high temperatures, TI Pb-Free products are suitable for use in specified lead-free processes.

**Pb-Free (RoHS Exempt):** This component has a RoHS exemption for either 1) lead-based flip-chip solder bumps used between the die and package, or 2) lead-based die adhesive used between the die and leadframe. The component is otherwise considered Pb-Free (RoHS compatible) as defined above.

**Green (RoHS & no Sb/Br):** TI defines "Green" to mean Pb-Free (RoHS compatible), and free of Bromine (Br) and Antimony (Sb) based flame retardants (Br or Sb do not exceed 0.1% by weight in homogeneous material)

<sup>(3)</sup> MSL, Peak Temp. -- The Moisture Sensitivity Level rating according to the JEDEC industry standard classifications, and peak solder temperature.

**Important Information and Disclaimer:** The information provided on this page represents TI's knowledge and belief as of the date that it is provided. TI bases its knowledge and belief on information provided by third parties, and makes no representation or warranty as to the accuracy of such information. Efforts are underway to better integrate information from third parties. TI has taken and continues to take reasonable steps to provide representative and accurate information but may not have conducted destructive testing or chemical analysis on incoming materials and chemicals. TI and TI suppliers consider certain information to be proprietary, and thus CAS numbers and other limited information may not be available for release.

In no event shall TI's liability arising out of such information exceed the total purchase price of the TI part(s) at issue in this document sold by TI to Customer on an annual basis.

## TAPE AND REEL INFORMATION



### QUADRANT ASSIGNMENTS FOR PIN 1 ORIENTATION IN TAPE



\*All dimensions are nominal

| Device      | Package Type | Package Drawing | Pins | SPQ  | Reel Diameter (mm) | Reel Width W1 (mm) | A0 (mm) | B0 (mm) | K0 (mm) | P1 (mm) | W (mm) | Pin1 Quadrant |
|-------------|--------------|-----------------|------|------|--------------------|--------------------|---------|---------|---------|---------|--------|---------------|
| CSD86360Q5D | SON          | DQY             | 8    | 2500 | 330.0              | 12.4               | 5.3     | 6.3     | 1.8     | 8.0     | 12.0   | Q2            |

**TAPE AND REEL BOX DIMENSIONS**



\*All dimensions are nominal

| Device      | Package Type | Package Drawing | Pins | SPQ  | Length (mm) | Width (mm) | Height (mm) |
|-------------|--------------|-----------------|------|------|-------------|------------|-------------|
| CSD86360Q5D | SON          | DQY             | 8    | 2500 | 367.0       | 367.0      | 35.0        |

## IMPORTANT NOTICE

Texas Instruments Incorporated and its subsidiaries (TI) reserve the right to make corrections, enhancements, improvements and other changes to its semiconductor products and services per JESD46, latest issue, and to discontinue any product or service per JESD48, latest issue. Buyers should obtain the latest relevant information before placing orders and should verify that such information is current and complete. All semiconductor products (also referred to herein as "components") are sold subject to TI's terms and conditions of sale supplied at the time of order acknowledgment.

TI warrants performance of its components to the specifications applicable at the time of sale, in accordance with the warranty in TI's terms and conditions of sale of semiconductor products. Testing and other quality control techniques are used to the extent TI deems necessary to support this warranty. Except where mandated by applicable law, testing of all parameters of each component is not necessarily performed.

TI assumes no liability for applications assistance or the design of Buyers' products. Buyers are responsible for their products and applications using TI components. To minimize the risks associated with Buyers' products and applications, Buyers should provide adequate design and operating safeguards.

TI does not warrant or represent that any license, either express or implied, is granted under any patent right, copyright, mask work right, or other intellectual property right relating to any combination, machine, or process in which TI components or services are used. Information published by TI regarding third-party products or services does not constitute a license to use such products or services or a warranty or endorsement thereof. Use of such information may require a license from a third party under the patents or other intellectual property of the third party, or a license from TI under the patents or other intellectual property of TI.

Reproduction of significant portions of TI information in TI data books or data sheets is permissible only if reproduction is without alteration and is accompanied by all associated warranties, conditions, limitations, and notices. TI is not responsible or liable for such altered documentation. Information of third parties may be subject to additional restrictions.

Resale of TI components or services with statements different from or beyond the parameters stated by TI for that component or service voids all express and any implied warranties for the associated TI component or service and is an unfair and deceptive business practice. TI is not responsible or liable for any such statements.

Buyer acknowledges and agrees that it is solely responsible for compliance with all legal, regulatory and safety-related requirements concerning its products, and any use of TI components in its applications, notwithstanding any applications-related information or support that may be provided by TI. Buyer represents and agrees that it has all the necessary expertise to create and implement safeguards which anticipate dangerous consequences of failures, monitor failures and their consequences, lessen the likelihood of failures that might cause harm and take appropriate remedial actions. Buyer will fully indemnify TI and its representatives against any damages arising out of the use of any TI components in safety-critical applications.

In some cases, TI components may be promoted specifically to facilitate safety-related applications. With such components, TI's goal is to help enable customers to design and create their own end-product solutions that meet applicable functional safety standards and requirements. Nonetheless, such components are subject to these terms.

No TI components are authorized for use in FDA Class III (or similar life-critical medical equipment) unless authorized officers of the parties have executed a special agreement specifically governing such use.

Only those TI components which TI has specifically designated as military grade or "enhanced plastic" are designed and intended for use in military/aerospace applications or environments. Buyer acknowledges and agrees that any military or aerospace use of TI components which have **not** been so designated is solely at the Buyer's risk, and that Buyer is solely responsible for compliance with all legal and regulatory requirements in connection with such use.

TI has specifically designated certain components which meet ISO/TS16949 requirements, mainly for automotive use. Components which have not been so designated are neither designed nor intended for automotive use; and TI will not be responsible for any failure of such components to meet such requirements.

### Products

|                              |  |
|------------------------------|--|
| Audio                        | <a href="http://www.ti.com/audio">www.ti.com/audio</a>                               |
| Amplifiers                   | <a href="http://amplifier.ti.com">amplifier.ti.com</a>                               |
| Data Converters              | <a href="http://dataconverter.ti.com">dataconverter.ti.com</a>                       |
| DLP® Products                | <a href="http://www.dlp.com">www.dlp.com</a>   |
| DSP                          | <a href="http://dsp.ti.com">dsp.ti.com</a>   |
| Clocks and Timers            | <a href="http://www.ti.com/clocks">www.ti.com/clocks</a>                             |
| Interface                    | <a href="http://interface.ti.com">interface.ti.com</a>                               |
| Logic                        | <a href="http://logic.ti.com">logic.ti.com</a>                                       |
| Power Mgmt                   | <a href="http://power.ti.com">power.ti.com</a>                                       |
| Microcontrollers             | <a href="http://microcontroller.ti.com">microcontroller.ti.com</a>                   |
| RFID                         | <a href="http://www.ti-rfid.com">www.ti-rfid.com</a>                                 |
| OMAP Applications Processors | <a href="http://www.ti.com/omap">www.ti.com/omap</a>                                 |
| Wireless Connectivity        | <a href="http://www.ti.com/wirelessconnectivity">www.ti.com/wirelessconnectivity</a> |

### Applications

|                               |  |
|-------------------------------|--|
| Automotive and Transportation | <a href="http://www.ti.com/automotive">www.ti.com/automotive</a>                         |
| Communications and Telecom    | <a href="http://www.ti.com/communications">www.ti.com/communications</a>                 |
| Computers and Peripherals     | <a href="http://www.ti.com/computers">www.ti.com/computers</a>                           |
| Consumer Electronics          | <a href="http://www.ti.com/consumer-apps">www.ti.com/consumer-apps</a>                   |
| Energy and Lighting           | <a href="http://www.ti.com/energy">www.ti.com/energy</a>                                 |
| Industrial                    | <a href="http://www.ti.com/industrial">www.ti.com/industrial</a>                         |
| Medical                       | <a href="http://www.ti.com/medical">www.ti.com/medical</a>                               |
| Security                      | <a href="http://www.ti.com/security">www.ti.com/security</a>                             |
| Space, Avionics and Defense   | <a href="http://www.ti.com/space-avionics-defense">www.ti.com/space-avionics-defense</a> |
| Video and Imaging             | <a href="http://www.ti.com/video">www.ti.com/video</a>                                   |

### TI E2E Community

[e2e.ti.com](http://e2e.ti.com)