

IS series

Sealed pushbutton switches •
threaded bushing Ø 12 mm • momentary



DISTINCTIVE FEATURES

- Threaded bushing models
- Compact, lightweight
- Tactile feedback
- Sealed to IP67



ENVIRONMENTAL SPECIFICATIONS

- Front panel sealing according to IEC 60529 : IP67
- Shock resistance : 100 g according to IEC 512-4, test 6c
- Vibration resistance : 10-500 Hz - 10 g according to IEC 512-4, test 6d
- Salt spray : IEC 512-6, test 11f
- Operating temperature : -40 °C to +85 °C (-40 °F to +185 °F)



ELECTRICAL SPECIFICATIONS

- Max. current/voltage rating with resistive load :
400 mA 32 VAC - 100 mA 48 VDC
- Initial contact resistance : 50 mΩ max.
- Insulation resistance : 1 GΩ min. at 500 VDC
- Dielectric strength : 1,000 Vrms
- Electrical life at full load : 500,000 cycles



GENERAL SPECIFICATIONS

- Panel thickness : 1.5 mm (.059) min. - 4 mm (.157) max.
- Total travel : 1.7 mm (.066) ± 0,3 mm
- Typical operating force : 4 N ± 3 N
- Low level or mechanical life : 1,000,000 cycles
- Torque (applied to nut) : 1 Nm max. with metal nut U166
1.5 Nm max. with plastic nut U4248
- Soldering : 300 °C (572 °F) max. for 3 seconds

The company reserves the right to change specifications without notice.

4006-022-002

shunto@126.com



IS series

Sealed pushbutton switches • threaded bushing Ø 12 mm • momentary



MATERIALS

- Case : thermoplastic UL94-V0
- Actuator : polyamide 6/6
- Bushing/bezel : polyamide 6/6
- Contacts : silver, gold plated
- Terminal seal : epoxy

APEM products may be recycled at end-of-life for the re-claiming of valuable metal components.

AGENCY APPROVAL



2 A 125 VAC/250 VAC
File E83438

Availability : consult factory for details of approved models.

Marking : to order switches marked UL, complete appropriate box of ordering format.



TERMINALS

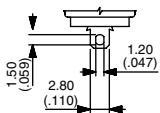

Solder lug S

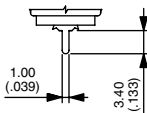

Straight P

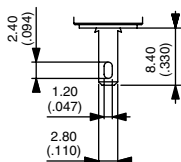

Quick-connect Z



ELECTRICAL FUNCTIONS

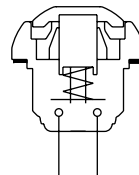

Function 3 (NO)



MOUNTING STANDARD BEZEL

PANEL CUT-OUT

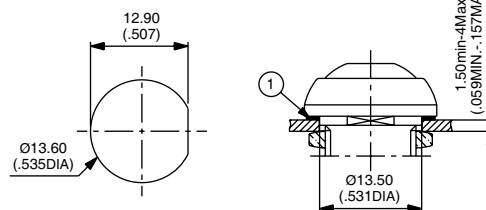

① - Flat seal

MATRIX MOUNTING

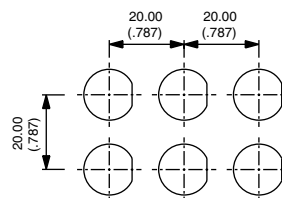

MOUNTING REDUCED MODEL

PANEL CUT-OUT

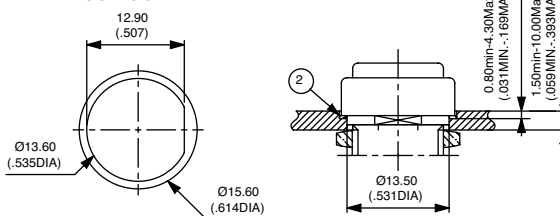

② - O-ring

MATRIX MOUNTING

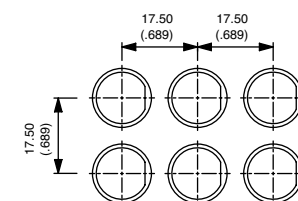

IS series

Sealed pushbutton switches • threaded bushing Ø 12 mm • momentary



BUILD YOUR PART NUMBER

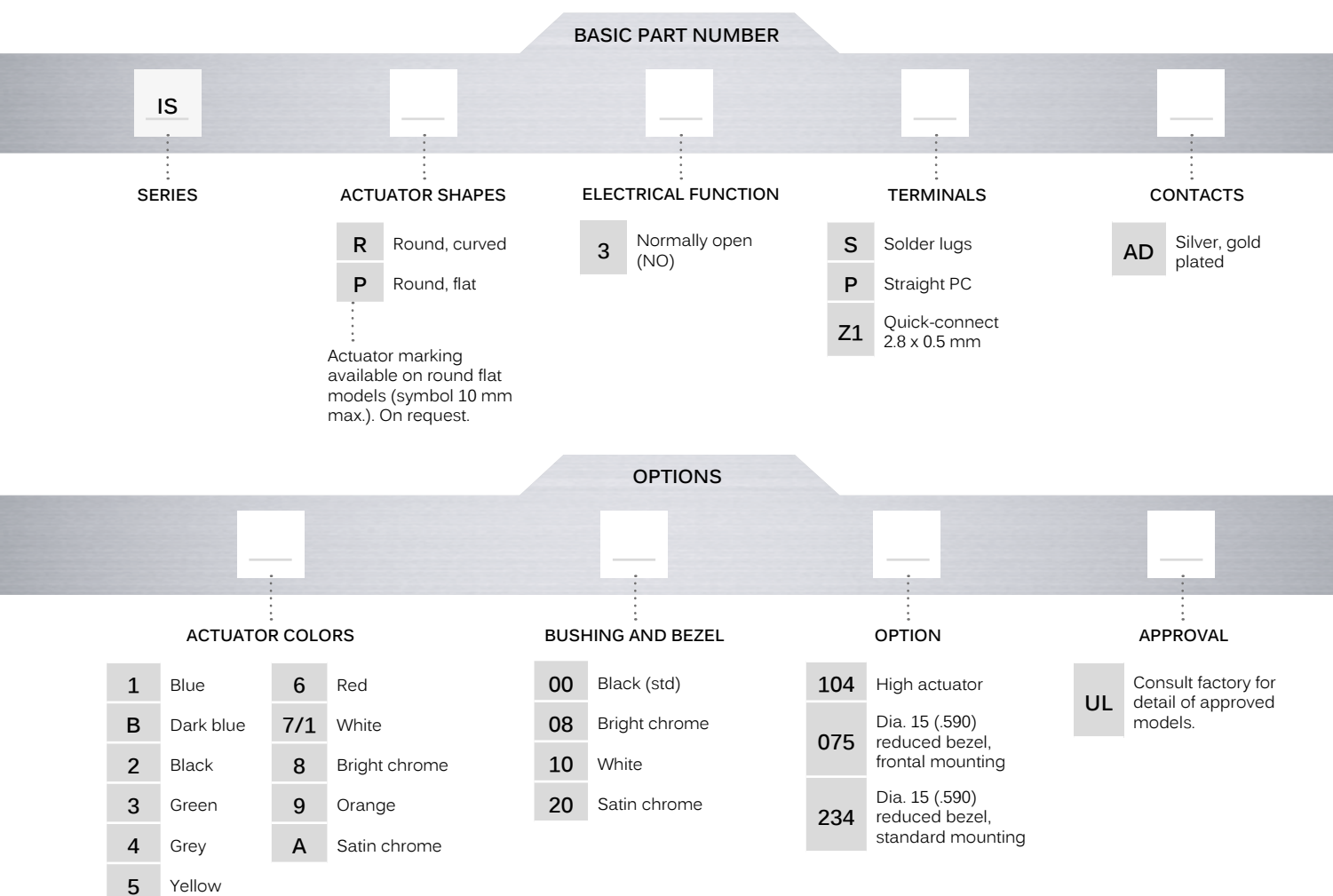

ABOUT THIS SERIES

On the following pages, you will find successively basic part numbers of switches and options in the same order as in above chart.

- Notice** : please note that not all combinations of above numbers are available. Refer to the following pages for further information.
- A sealing boot** is available to protect the switches against frost and sand (P/N U5125). See "Sealing Boots" section of website.
- Mounting accessories** : Standard hardware supplied : 1 flat seal. Plastic nut 17 mm (.669) across flats, thickness 4 mm (.157) available on request. Part number U4248.

IS series

Sealed pushbutton switches • threaded bushing Ø 12 mm • momentary

SOLDER LUG TERMINALS



Curved actuator

ISR3SAD



Normally Open

Flat actuator

ISP3SAD



Normally Open

Also available with straight PC terminals : **IS•3PAD**
or quick-connect terminals : **IS•3Z1AD**

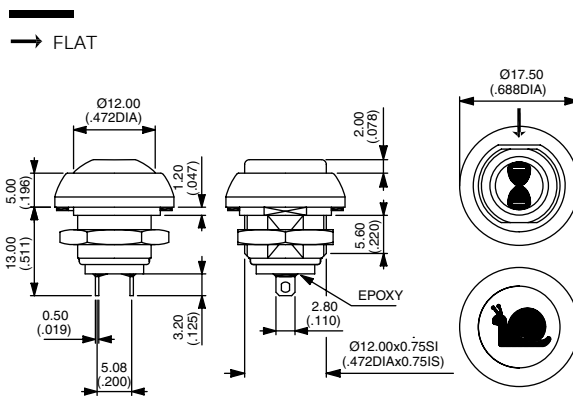

ACTUATOR COLORS



- 1 Blue
- B Dark blue
- 2 Black
- 3 Green
- 4 Grey
- 5 Yellow
- 6 Red
- 7/1 White
- 8 Bright chrome
- 9 Orange
- A Satin chrome

BUSHING AND BEZEL



- 00 Black (standard)
- 08 Bright chrome
- 10 White
- 20 Satin chrome

IS series

Sealed pushbutton switches • threaded bushing Ø 12 mm • momentary

OPTIONS



- 104 High actuator
- 075 Dia. 15 (.590) reduced bezel, mounting of the switch from the front into a threaded panel cut-out
- 234 Dia. 15 (.590) reduced bezel, standard mounting

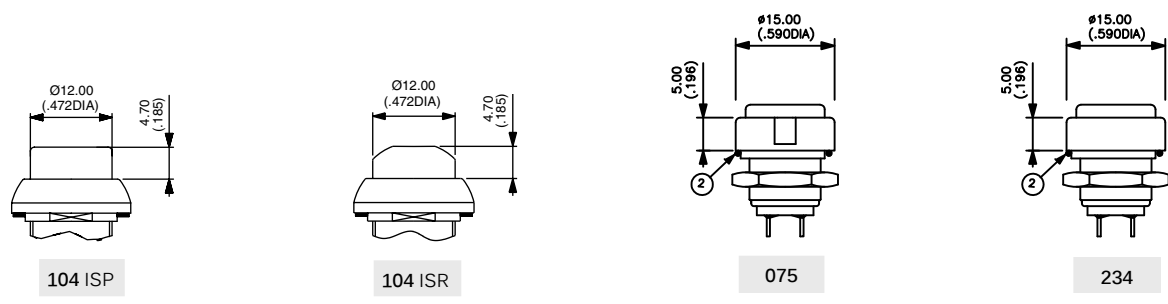

AGENCY APPROVAL



UL
Availability : consult factory for details of approved models.
Marking : to order switches marked UL, complete appropriate box of ordering format.

EXAMPLE OF CUSTOM SWITCH



ISR3FADB22X1248-01

- Painted bushing and actuator, soft feel
- Flying leads (55 mm) + connector
- Overmolded rear part