

- Complies with Directive 2002/95/EC (RoHS)
- Moisture Sensitivity Level: 1

RoHS  
Compliant

SF2446E

435 MHz  
SAW Filter

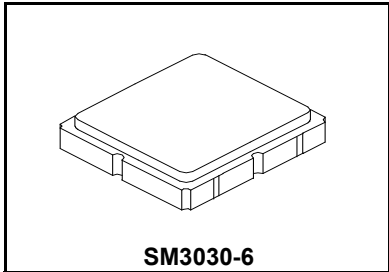

**Maximum Rating**

Rating	Value	Units
Input Power Level	10	dB <sub>m</sub>
DC Voltage	10	V
Operable Temperature Range	-45 to +125	°C
Specification Temperature Range	-40 to +85	°C
Storage Temperature in Tape and Reel	-45 to +85	°C
Moisture Sensitivity Level	1	MSL

**Electrical Characteristics**

Characteristic	Sym	Notes	Min	Typ	Max	Units
Center Frequency	f <sub>C</sub>			435		MHz
3dB Bandwidth			10	23		MHz
Insertion Loss, 430 to 440 MHz	IL			1.9	3.0	dB
Amplitude Ripple, 430 to 440 MHz				0.8	2.0	dB
Attenuation Referenced to 0 dB						dB
0.3 to 386.6 MHz			45	54		
386.6 to 396.6 MHz			46	52		
474.8 to 480.8 MHz			45	54		
480.8 to 680 MHz			45	50		
680 to 1000 MHz			35	46		
Temperature Coefficient of Frequency				-36		ppm/°C

Case Style	SM3030-6 3.0 x 3.0 mm Nominal Footprint
Lid Symbolization (Y=year, WW=week, S=shift) dot=pin 1 indicator	B3, <u>YWWS</u>

**Measurement Circuit**

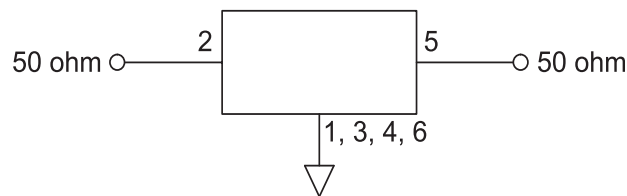

# Frequency Characteristics

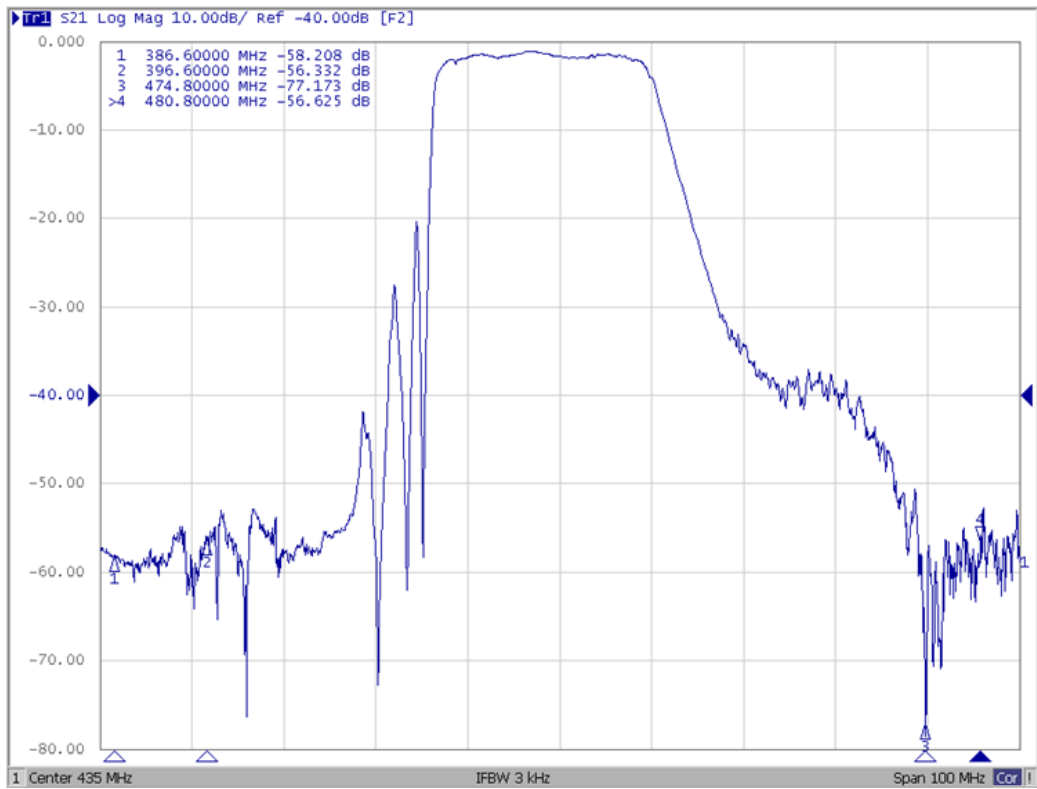
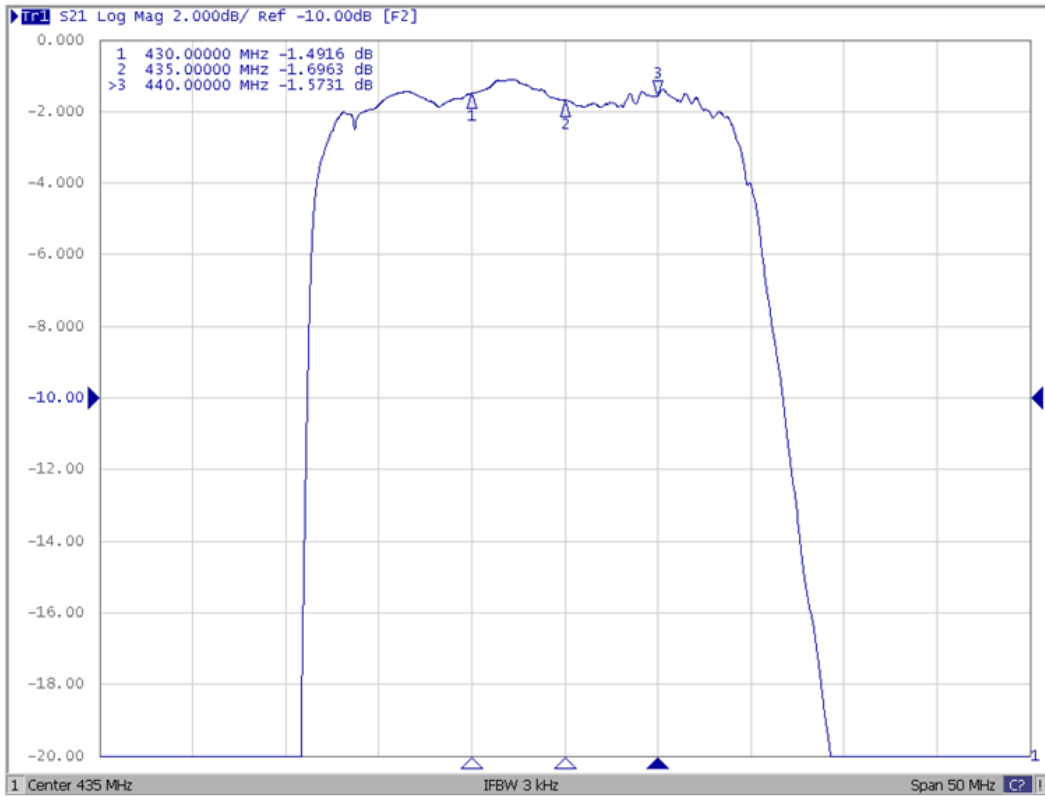

## 6- Terminal Ceramic Surface Mount Case 3.0 x 3.0 mm Nominal Footprint

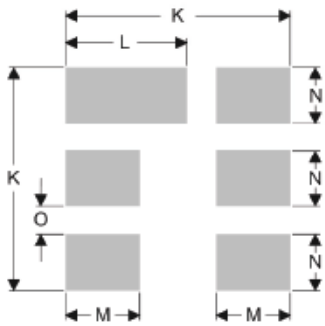
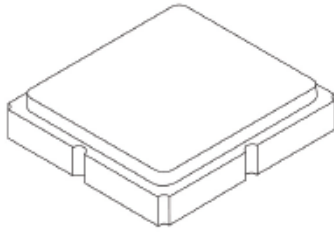

**PCB Footprint Top View**

Dimension	mm			Inches		
	Min	Nom	Max	Min	Nom	Max
A	2.87	3.0	3.13	0.113	0.118	0.123
B	2.87	3.0	3.13	0.113	0.118	0.123
C	1.12	1.25	1.38	0.044	0.049	0.054
D	0.77	0.90	1.03	0.030	0.035	0.040
E	2.67	2.80	2.93	0.105	0.110	0.115
F	1.47	1.60	1.73	0.058	0.063	0.068
G	0.72	0.85	0.98	0.028	0.033	0.038
H	1.37	1.50	1.63	0.054	0.059	0.064
I	0.47	0.60	0.73	0.019	0.024	0.029
J	1.17	1.30	1.43	0.046	0.051	0.056
K		3.20			0.126	
L		1.70			0.067	
M		1.05			0.041	
N		0.81			0.032	
O		0.38			0.015	

### Case Materials

Materials	
Solder Pad Plating	0.3 to 1.0 $\mu\text{m}$ Gold over 1.27 to 8.89 $\mu\text{m}$ Nickel
Lid Plating	2.0 to 3.0 $\mu\text{m}$ Nickel
Body	$\text{Al}_2\text{O}_3$ Ceramic

**Top View**

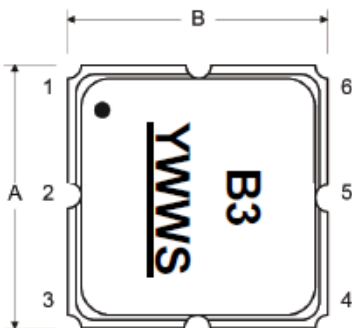

**Bottom View**

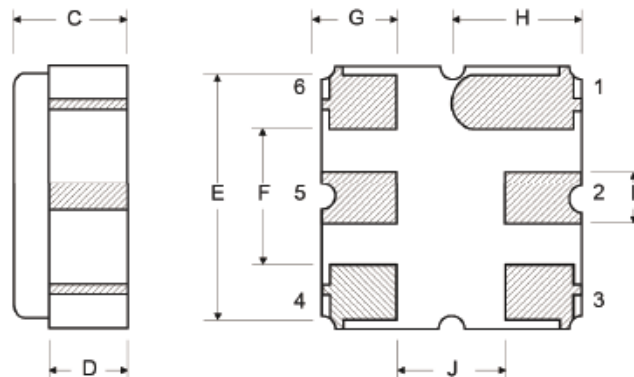

## Tape and Reel Specifications

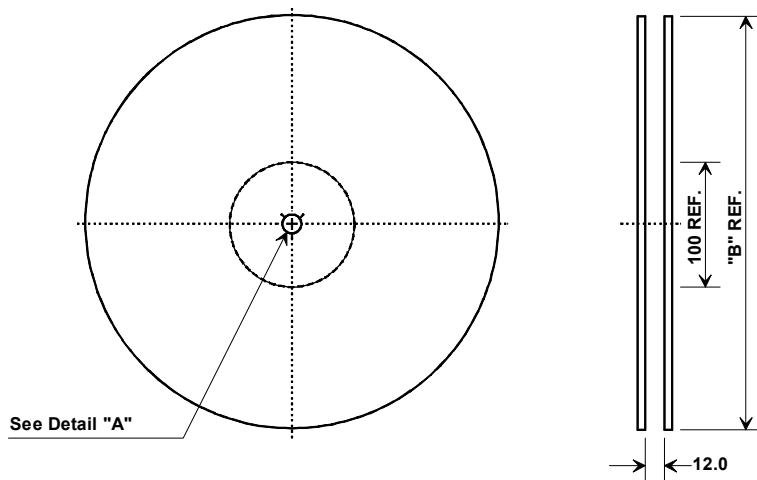

Tape and Reel Standard per ANSI/EIA-481

"B"		Quantity Per Reel
Inches	millimeters	
7	178	500
13	330	3000

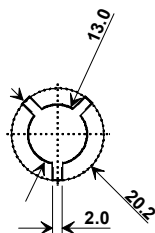

### COMPONENT ORIENTATION and DIMENSIONS

Carrier Tape Dimensions	
<b>Ao</b>	4.25 mm
<b>Bo</b>	4.25 mm
<b>Ko</b>	1.30 mm
<b>Pitch</b>	8.0 mm
<b>W</b>	12.0 mm

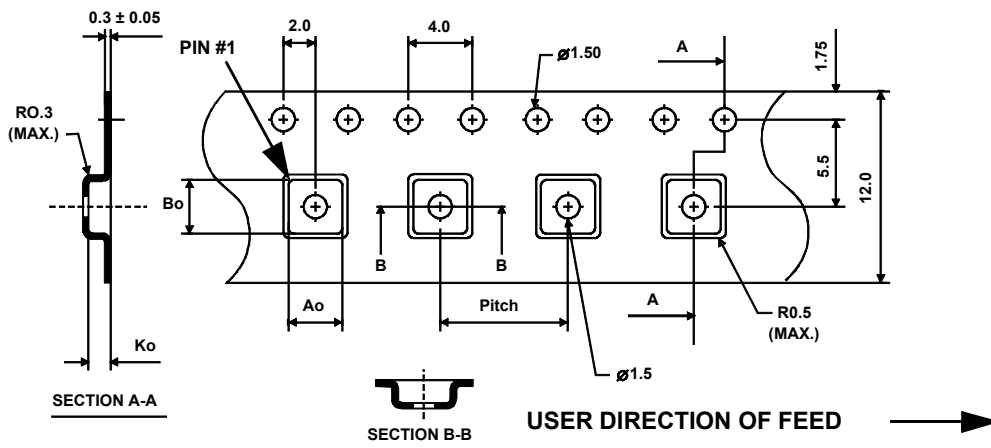

## Recommended Reflow Profile

1. Preheating shall be fixed at 150~180°C for 60~90 seconds.
2. Ascending time to preheating temperature 150°C shall be 30 seconds min.
3. Heating shall be fixed at 220°C for 50~80 seconds and at 260°C +0/-5°C peak (10 seconds).
4. Time: 5 times maximum.

