

## LMR33620-Q1 3.8V 至 36V、2A 同步降压转换器

### 1 特性

- 符合面向汽车应用的 AEC-Q100 标准：
  - 温度等级 1：-40°C 至 +125°C，T<sub>A</sub>
- 提供功能安全
  - 可帮助进行功能安全系统设计的文档
- 专用于条件严苛的汽车应用
  - 输入电压范围：3.8V 至 36V
  - 输出电压范围：1V 至 24V
  - 输出电流：2A
  - 75mΩ/50mΩ R<sub>DS-ON</sub> 功率 MOSFET
  - 峰值电流模式控制
  - 最短导通时间很短，只有 68ns
  - 频率：400kHz、1.4MHz、2.1MHz
  - 集成补偿网络
- 低 EMI 和开关噪声
  - {13}Hotrod{14} 封装
  - 并行输入电流路径
- 可在所有负载下进行高效电源转换
  - 峰值效率 > 95%
  - 5 μA 的低关断静态电流
  - 25 μA 的低工作静态电流
- 使用 LMR33620-Q1 并借助 WEBENCH® Power Designer 创建定制设计方案

### 2 应用

- 信息娱乐系统与仪表组：USB 充电
- 远程信息处理控制单元

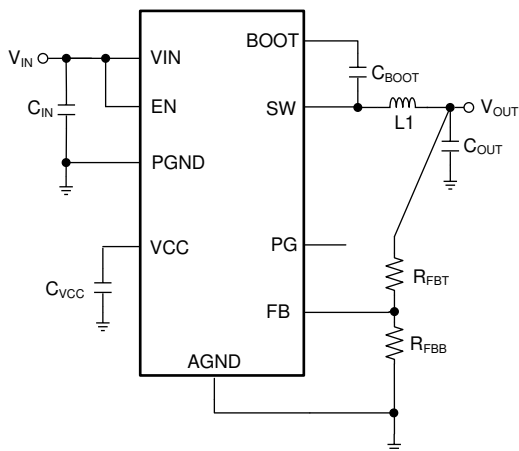

简化版原理图

### 3 说明

LMR33620-Q1 稳压器符合汽车标准，是一款简单易用的同步降压直流/直流转换器，可提供出色的效率，适用于条件严苛的应用。LMR33620-Q1 能够使用高达 36V 的输入电压驱动高达 2A 的负载电流。LMR33620-Q1 以超小的解决方案尺寸提供出色的轻负载效率和输出精度。电源正常状态标志和精密使能端等特性有助于实现灵活而又易用的解决方案，适用于广泛的应用。LMR33620-Q1 在轻负载条件下自动折返频率以提高效率。此器件通过集成技术省去了大部分外部组件，并提供专为实现简单 PCB 布局而设计的引脚排列方式。保护特性包括热关断、输入欠压锁定、逐周期电流限制和断续短路保护。LMR33620-Q1 可采用具有可湿性侧面的 12 引脚 3mm × 2mm 新型 VQFN 封装。

#### 器件信息

| 器件型号        | 封装 <sup>(1)</sup> | 封装尺寸 (标称值)      |
|-------------|-------------------|-----------------|
| LMR33620-Q1 | VQFN (12)         | 3.00mm × 2.00mm |

(1) 如需了解所有可用封装，请参阅数据表末尾的可订购产品附录。

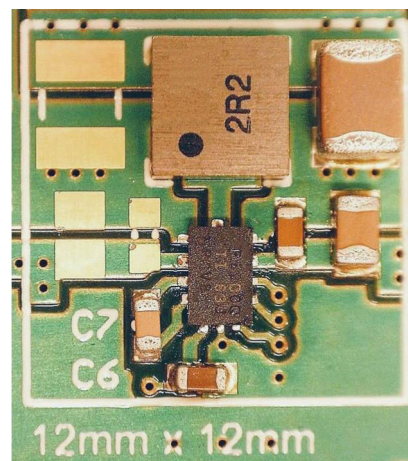

超少组件示例



## Table of Contents

|  |    |  |    |
|--|----|--|----|
| <b>1 特性</b> .....                              | 1  | 7.4 Device Functional Modes.....                 | 15 |
| <b>2 应用</b> .....                              | 1  | <b>8 Application and Implementation</b> .....    | 19 |
| <b>3 说明</b> .....                              | 1  | 8.1 Application Information.....                 | 19 |
| <b>4 修订历史记录</b> .....                          | 2  | 8.2 Typical Application.....                     | 19 |
| <b>5 Pin Configuration and Functions</b> ..... | 4  | 8.3 What to Do and What Not to Do.....           | 32 |
| <b>6 Specifications</b> .....                  | 5  | <b>9 Power Supply Recommendations</b> .....      | 33 |
| 6.1 Absolute Maximum Ratings.....              | 5  | <b>10 Layout</b> .....                           | 34 |
| 6.2 ESD Ratings.....                           | 5  | 10.1 Layout Guidelines.....                      | 34 |
| 6.3 Recommended Operating Conditions.....      | 5  | 10.2 Layout Example.....                         | 36 |
| 6.4 Thermal Information.....                   | 6  | <b>11 Device and Documentation Support</b> ..... | 37 |
| 6.5 Electrical Characteristics.....            | 6  | 11.1 Device Support.....                         | 37 |
| 6.6 Timing Characteristics.....                | 8  | 11.2 Documentation Support.....                  | 37 |
| 6.7 System Characteristics.....                | 9  | 11.3 支持资源.....                                   | 37 |
| 6.8 Typical Characteristics.....               | 10 | 11.4 接收文档更新通知.....                               | 37 |
| <b>7 Detailed Description</b> .....            | 11 | 11.5 Trademarks.....                             | 37 |
| 7.1 Overview.....                              | 11 | 11.6 静电放电警告.....                                 | 38 |
| 7.2 Functional Block Diagram.....              | 11 | 11.7 术语表.....                                    | 38 |
| 7.3 Feature Description.....                   | 12 |  |    |

## 4 修订历史记录

注：以前版本的页码可能与当前版本的页码不同

| <b>Changes from Revision A (November 2018) to Revision B (March 2019)</b> | <b>Page</b> |
|---|-------------|
| • 在整个数据表中添加了 WSON 信息.....   | 1           |
| • Changed block diagram to fix drawing error.....                         | 11          |

---

| <b>Changes from Revision * (June 2018) to Revision A (November 2018)</b> | <b>Page</b> |
|--|-------------|
| • 首次发布量产数据数据表.....   | 1           |

## Device Comparison Table

| DEVICE OPTION  | PACKAGE                              | FREQUENCY | RATED CURRENT | OUTPUT VOLTAGE |
|----------------|--------------------------------------|-----------|---------------|----------------|
| LMR33620AQRNX  | RNX (12-pin VQFN)<br>3 × 2 × 0.85 mm | 400 kHz   | 2 A           | Adjustable     |
| LMR33620BQRNX  |                                      | 1400 kHz  | 2 A           |                |
| LMR33620CQRNX  |                                      | 2100 kHz  | 2 A           |                |
| LMR33620CQ5RNX | RNX (12-pin VQFN)<br>3 × 2 × 0.85 mm | 2100 kHz  | 2 A           | 5-V fixed      |
| LMR33620CQ3RNX | RNX (12-pin VQFN)<br>3 × 2 × 0.85 mm | 2100 kHz  | 2 A           | 3.3-V fixed    |
| LMR33620AQ5RNX | RNX (12-pin VQFN)<br>3 × 2 × 0.85 mm | 400 kHz   | 2 A           | 5-V fixed      |

## 5 Pin Configuration and Functions



图 5-1. 12-Pin VQFN RNX Package (Top View)

表 5-1. Pin Functions

| PIN   |      | TYPE | DESCRIPTION  |
|-------|------|------|--|
| NO.   | NAME |      |  |
| 1, 11 | PGND | G    | Power ground terminal. Connect to system ground and AGND. Connect to a bypass capacitor with short wide traces.  |
| 2, 10 | VIN  | P    | Input supply to regulator. Connect a high-quality bypass capacitor(s) directly to this pin and PGND.   |
| 3     | NC   | —    | On the VQFN package, connect the SW pin to NC on the PCB. This simplifies the connection from the $C_{BOOT}$ capacitor to the SW pin. This pin has no internal connection to the regulator.  |
| 4     | BOOT | P    | Boot-strap supply voltage for internal high-side driver. Connect a high-quality 100-nF capacitor from this pin to the SW pin. On the VQFN package connect the SW pin to NC on the PCB. This simplifies the connection from the $C_{BOOT}$ capacitor to the SW pin. |
| 5     | VCC  | P    | Internal 5-V LDO output. Used as supply to internal control circuits. Do not connect to external loads. Can be used as logic supply for power-good flag. Connect a high quality 1- $\mu$ F capacitor from this pin to GND.   |
| 6     | AGND | G    | Analog ground for regulator and system. Ground reference for internal references and logic. All electrical parameters are measured with respect to this pin. Connect to system ground on PCB.  |
| 7     | FB   | A    | Feedback input to regulator. Connect to tap point of feedback voltage divider. DO NOT FLOAT. DO NOT GROUND. With the fixed output voltage version, connect this input directly to $V_{OUT}$ near the output capacitor.   |
| 8     | PG   | A    | Open drain power-good flag output. Connect to suitable voltage supply through a current limiting resistor. High = power OK, low = power bad. Flag pulls low when EN = Low. Can be left open when not used.   |
| 9     | EN   | A    | Enable input to regulator. High = ON, low = OFF. Can be connected directly to VIN; DO NOT FLOAT.   |
| 12    | SW   | P    | Regulator switch node. Connect to power inductor. On the VQFN package the SW pin must be connected to NC on the PCB. This simplifies the connection from the $C_{BOOT}$ capacitor to the SW pin.   |

A = Analog, P = Power, G = Ground

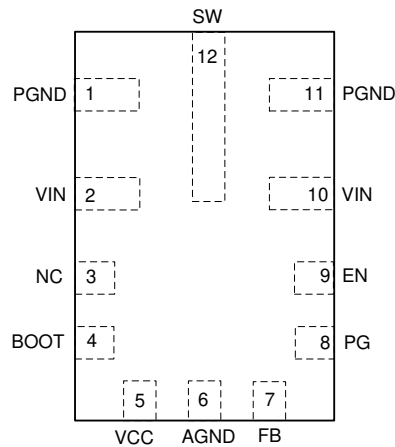
## 6 Specifications

### 6.1 Absolute Maximum Ratings

Over the recommended operating junction temperature range<sup>(1)</sup>

| PARAMETER        |  | MIN   | MAX                   | UNIT |
|------------------|--|-------|-----------------------|------|
| Voltages         | VIN to PGND                            | - 0.3 | 38                    | V    |
|                  | EN to AGND <sup>(2)</sup>              | - 0.3 | V <sub>IN</sub> + 0.3 |      |
|                  | FB to AGND                             | - 0.3 | 5.5                   |      |
|                  | PG to AGND <sup>(2)</sup>              | 0     | 22                    |      |
|                  | AGND to PGND                           | - 0.3 | 0.3                   |      |
|                  | SW to PGND                             | - 0.3 | V <sub>IN</sub> + 0.3 | V    |
|                  | SW to PGND less than 100-ns transients | - 3.5 | 38                    |      |
|                  | BOOT to SW                             | - 0.3 | 5.5                   |      |
|                  | VCC to AGND <sup>(4)</sup>             | - 0.3 | 5.5                   |      |
| T <sub>J</sub>   | Junction temperature <sup>(3)</sup>    | - 40  | 150                   | °C   |
| T <sub>stg</sub> | Storage temperature                    | - 55  | 150                   | °C   |

- (1) Stresses beyond those listed under *Absolute Maximum Ratings* may cause permanent damage to the device. These are stress ratings only, which do not imply functional operation of the device at these or any other conditions beyond those indicated under *Recommended Operating Conditions*. Exposure to absolute-maximum-rated conditions for extended periods may affect device reliability.
- (2) The voltage on this pin must not exceed the voltage on the VIN pin by more than 0.3 V
- (3) Operating at junction temperatures greater than 125°C, although possible, degrades the lifetime of the device.
- (4) Under some operating conditions the VCC LDO voltage may increase beyond 5.5V.

### 6.2 ESD Ratings

|                    |                         |   | VALUE | UNIT |
|--------------------|-------------------------|---|-------|------|
| V <sub>(ESD)</sub> | Electrostatic discharge | Human-body model (HBM), per AEC Q100-002 <sup>(1)</sup><br>HBM ESD Classification Level 2 | ±2500 | V    |
|                    |                         | Charged-device model (CDM), per AEC Q100-011<br>CDM ESD Classification Level C5           | ±750  |      |

- (1) AEC Q100-002 indicates that HBM stressing shall be in accordance with ANSI/ESDA/JEDEC JS-001 specification.

### 6.3 Recommended Operating Conditions

Over the recommended operating temperature range of - 40 °C to 125 °C (unless otherwise noted) <sup>(1)</sup>

|                           |                                 | MIN | MAX             | UNIT |
|---------------------------|---------------------------------|-----|-----------------|------|
| Input voltage             | VIN to PGND                     | 3.8 | 36              | V    |
|                           | EN <sup>(2)</sup>               | 0   | V <sub>IN</sub> |      |
|                           | PG <sup>(2)</sup>               | 0   | 18              |      |
| Adjustable output voltage | V <sub>OUT</sub> <sup>(3)</sup> | 1   | 24              | V    |
| Output current            | I <sub>OUT</sub>                | 0   | 2               | A    |

- (1) Recommended operating conditions indicate conditions for which the device is intended to be functional, but do not ensure specific performance limits. For ensured specifications, see [§ 6.5](#).
- (2) The voltage on this pin must not exceed the voltage on the VIN pin by more than 0.3 V.
- (3) The maximum output voltage can be extended to 95% of V<sub>IN</sub>; contact TI for details. Under no conditions should the output voltage be allowed to fall below zero volts.

## 6.4 Thermal Information

The value of  $R_{\theta JA}$  given in this table is only valid for comparison with other packages and can not be used for design purposes. These values were calculated in accordance with JESD 51-7, and simulated on a 4-layer JEDEC board. They do not represent the performance obtained in an actual application. For design information see *Maximum Ambient Temperature* section.

| THERMAL METRIC <sup>(1) (2)</sup> |  | LMR336x0            | UNIT |
|-----------------------------------|--|---------------------|------|
|                                   |  | RNX (VQFN)          |      |
|                                   |  | 12 PINS             |      |
| $R_{\theta JA}$                   | Junction-to-ambient thermal resistance       | 72.5 <sup>(2)</sup> | °C/W |
| $R_{\theta JC(top)}$              | Junction-to-case (top) thermal resistance    | 35.9                | °C/W |
| $R_{\theta JB}$                   | Junction-to-board thermal resistance         | 23.3                | °C/W |
| $\psi_{JT}$                       | Junction-to-top characterization parameter   | 0.8                 | °C/W |
| $\psi_{JB}$                       | Junction-to-board characterization parameter | 23.5                | °C/W |
| $R_{\theta JC(bot)}$              | Junction-to-case (bottom) thermal resistance | N/A                 | °C/W |

- (1) For more information about traditional and new thermal metrics, see the [Semiconductor and IC Package Thermal Metrics](#) application report.
- (2) The value of  $R_{\theta JA}$  given in this table is only valid for comparison with other packages and can not be used for design purposes. These values were calculated in accordance with JESD 51-7, and simulated on a 4-layer JEDEC board. They do not represent the performance obtained in an actual application. For design information see *Maximum Ambient Temperature* section.

## 6.5 Electrical Characteristics

Limits apply over the operating junction temperature ( $T_J$ ) range of  $-40^{\circ}\text{C}$  to  $+125^{\circ}\text{C}$ , unless otherwise stated. Minimum and maximum limits are specified through test, design or statistical correlation. Typical values represent the most likely parametric norm at  $T_J = 25^{\circ}\text{C}$ , and are provided for reference purposes only. Unless otherwise stated, the following conditions apply:

$V_{IN} = 12\text{ V}$ ,  $V_{EN} = 4\text{ V}$ .

| PARAMETER                         |  | TEST CONDITIONS                           | MIN   | TYP   | MAX   | UNIT          |
|-----------------------------------|--|---|-------|-------|-------|---------------|
| <b>SUPPLY VOLTAGE</b>             |  |   |       |       |       |               |
| $V_{IN}$                          | Minimum operating input voltage                                  |   |       |       | 3.8   | V             |
| $I_Q$                             | Non-switching input current; measured at VIN pin <sup>(2)</sup>  | $V_{FB} = 1.2\text{ V}$                   |       | 24    | 34    | $\mu\text{A}$ |
| $I_{SD}$                          | Shutdown quiescent current; measured at VIN pin                  | $EN = 0$                                  |       | 5     | 10    | $\mu\text{A}$ |
| <b>ENABLE</b>                     |  |   |       |       |       |               |
| $V_{EN-VCC-H}$                    | EN input level required to turn on internal LDO                  | Rising threshold                          |       |       | 1     | V             |
| $V_{EN-VCC-L}$                    | EN input level required to turn off internal LDO                 | Falling threshold                         | 0.3   |       |       | V             |
| $V_{EN-H}$                        | EN input level required to start switching                       | Rising threshold                          | 1.2   | 1.231 | 1.26  | V             |
| $V_{EN-HYS}$                      | Hysteresis below $V_{EN-H}$                                      | Hysteresis below $V_{EN-H}$ ; falling     |       | 100   |       | mV            |
| $I_{LKG-EN}$                      | Enable input leakage current                                     | $V_{EN} = 3.3\text{ V}$                   |       | 0.2   |       | nA            |
| <b>INTERNAL SUPPLIES</b>          |  |   |       |       |       |               |
| VCC                               | Internal LDO output voltage appearing at the VCC pin             | $6\text{ V} \leq V_{IN} \leq 36\text{ V}$ | 4.75  | 5     | 5.25  | V             |
| $V_{BOOT-UVLO}$                   | Bootstrap voltage undervoltage lock-out threshold <sup>(3)</sup> |   |       | 2.2   |       | V             |
| <b>VOLTAGE REFERENCE (FB PIN)</b> |  |   |       |       |       |               |
| $V_{FB}$                          | Feedback voltage; ADJ option                                     |   | 0.985 | 1     | 1.015 | V             |
| $V_{FB}$                          | Feedback voltage; 3.3-V fixed option                             | 3.3 V fixed output voltage option         | 3.26  | 3.3   | 3.36  | V             |
| $V_{FB}$                          | Feedback voltage; 5-V fixed option                               | 5 V fixed output voltage option           | 4.95  | 5     | 5.095 | V             |
| $I_{FB}$                          | Current into FB pin; ADJ option                                  | $FB = 1\text{ V}$                         |       | 0.2   | 50    | nA            |

Limits apply over the operating junction temperature ( $T_J$ ) range of  $-40^{\circ}\text{C}$  to  $+125^{\circ}\text{C}$ , unless otherwise stated. Minimum and maximum limits are specified through test, design or statistical correlation. Typical values represent the most likely parametric norm at  $T_J = 25^{\circ}\text{C}$ , and are provided for reference purposes only. Unless otherwise stated, the following conditions apply:  $V_{IN} = 12\text{ V}$ ,  $V_{EN} = 4\text{ V}$ .

| PARAMETER                              |  | TEST CONDITIONS   | MIN  | TYP      | MAX       | UNIT          |
|--|--|---|------|----------|-----------|---------------|
| $I_{FB}$                               | Current into FB pin; 3.3-V fixed option                          | 3.3 V fixed output voltage option, FB = 3.3 V                           |      | 1.6      | 2         | $\mu\text{A}$ |
| $I_{FB}$                               | Current into FB pin; 5-V fixed option                            | 5 V fixed output voltage option, FB = 5 V                               |      | 2.9      | 3.5       | $\mu\text{A}$ |
| <b>CURRENT LIMITS<sup>(4)</sup></b>    |  |   |      |          |           |               |
| $I_{SC}$                               | High-side current limit  | LMR33620  | 2.9  | 3.5      | 4         | A             |
| $I_{LIMIT}$                            | Low-side current limit   | LMR33620  | 1.95 | 2.45     | 2.9       | A             |
| $I_{PEAK-MIN}$                         | Minimum peak inductor current                                    | LMR33620  |      | 0.54     |           | A             |
| $I_{ZC}$                               | Zero current detector threshold                                  |   |      | -0.106   |           | A             |
| <b>SOFT START</b>                      |  |   |      |          |           |               |
| $t_{SS}$                               | Internal soft-start time   |   | 2.9  | 4        | 6         | ms            |
| <b>POWER GOOD (PG PIN)</b>             |  |   |      |          |           |               |
| $V_{PG-HIGH-UP}$                       | Power-good upper threshold - rising                              | % of FB voltage   | 105% | 107%     | 110%      |               |
| $V_{PG-HIGH-DN}$                       | Power-good upper threshold - falling                             | % of FB voltage   | 103% | 105%     | 108%      |               |
| $V_{PG-LOW-UP}$                        | Power-good lower threshold - rising                              | % of FB voltage   | 92%  | 94%      | 97%       |               |
| $V_{PG-LOW-DN}$                        | Power-good lower threshold - falling                             | % of FB voltage   | 90%  | 92%      | 95%       |               |
| $V_{PG-HIGH-UP}$ (fixed output option) | Power-good upper threshold - rising Fixed output voltage option  | % of FB voltage   | 104% | 106%     | 110%      |               |
| $V_{PG-HIGH-DN}$ (fixed output option) | Power-good upper threshold - falling Fixed output voltage option | % of FB voltage   | 102% | 104%     | 108%      |               |
| $V_{PG-LOW-UP}$ (fixed output option)  | Power-good lower threshold - rising Fixed output voltage option  | % of FB voltage   | 91%  | 93%      | 97%       |               |
| $V_{PG-LOW-DN}$ (fixed output option)  | Power-good lower threshold - falling Fixed output voltage option | % of FB voltage   | 89%  | 91%      | 95%       |               |
| $t_{PG}$                               | Power-good glitch filter delay <sup>(1)</sup>                    |   | 60   |          | 170       | $\mu\text{s}$ |
| $R_{PG}$                               | Power-good flag $R_{DS(ON)}$                                     | $V_{IN} = 12\text{ V}$ , $V_{EN} = 4\text{ V}$<br>$V_{EN} = 0\text{ V}$ |      | 76<br>35 | 150<br>60 | $\Omega$      |
| $V_{IN-PG}$                            | Minimum input voltage for proper PG function                     | 50- $\mu\text{A}$ , $EN = 0\text{ V}$                                   |      |          | 2         | V             |
| $V_{PG}$                               | PG logic low output  | 50- $\mu\text{A}$ , $EN = 0\text{ V}$ , $V_{IN} = 2\text{ V}$           |      |          | 0.2       | V             |
| <b>OSCILLATOR</b>                      |  |   |      |          |           |               |
| $f_{SW}$                               | Switching frequency  | "A" Version   | 340  | 400      | 460       | kHz           |
| $f_{SW}$                               | Switching frequency  | "B" Version   | 1.2  | 1.4      | 1.6       | MHz           |
| $f_{SW}$                               | Switching frequency  | "C" Version, RNX package  | 1.8  | 2.1      | 2.3       | MHz           |

Limits apply over the operating junction temperature ( $T_J$ ) range of  $-40^{\circ}\text{C}$  to  $+125^{\circ}\text{C}$ , unless otherwise stated. Minimum and maximum limits are specified through test, design or statistical correlation. Typical values represent the most likely parametric norm at  $T_J = 25^{\circ}\text{C}$ , and are provided for reference purposes only. Unless otherwise stated, the following conditions apply:  $V_{IN} = 12\text{ V}$ ,  $V_{EN} = 4\text{ V}$ .

| PARAMETER      |                                | TEST CONDITIONS | MIN | TYP | MAX | UNIT             |
|----------------|--------------------------------|-----------------|-----|-----|-----|------------------|
| <b>MOSFETS</b> |                                |                 |     |     |     |                  |
| $R_{DS-ON-HS}$ | High-side MOSFET ON-resistance | RNX package     |     | 75  | 145 | $\text{m}\Omega$ |
| $R_{DS-ON-LS}$ | Low-side MOSFET ON-resistance  | RNX package     |     | 50  | 95  | $\text{m}\Omega$ |

- (1) See *Power-Good Flag Output* for details.
- (2) This is the current used by the device open loop. It does not represent the total input current of the system when in regulation.
- (3) When the voltage across the  $C_{BOOT}$  capacitor falls below this voltage, the low side MOSFET is turned on to recharge  $C_{BOOT}$ .
- (4) The current limit values in this table are tested, open loop, in production. They may differ from those found in a closed loop application.

## 6.6 Timing Characteristics

Limits apply over the operating junction temperature ( $T_J$ ) range of  $-40^{\circ}\text{C}$  to  $+125^{\circ}\text{C}$ , unless otherwise stated. Minimum and maximum limits are specified through test, design or statistical correlation. Typical values represent the most likely parametric norm at  $T_J = 25^{\circ}\text{C}$ , and are provided for reference purposes only. Unless otherwise stated, the following conditions apply:  $V_{IN} = 12\text{ V}$ ,  $V_{EN} = 4\text{ V}$ .

|               |                         |             | MIN | NOM | MAX | UNIT          |
|---------------|-------------------------|-------------|-----|-----|-----|---------------|
| $t_{ON-MIN}$  | Minimum switch on-time  | RNX package |     | 68  | 80  | ns            |
| $t_{OFF-MIN}$ | Minimum switch off-time | RNX package |     | 52  | 70  | ns            |
| $t_{ON-MAX}$  | Maximum switch on-time  |             |     | 7   | 9   | $\mu\text{s}$ |



## 6.7 System Characteristics

The following specifications apply to a typical applications circuit, with nominal component values. Specifications in the typical (TYP) column apply to  $T_J = 25^\circ\text{C}$  only. Specifications in the minimum (MIN) and maximum (MAX) columns apply to the case of typical components over the temperature range of  $T_J = -40^\circ\text{C}$  to  $125^\circ\text{C}$ . *These specifications are not ensured by production testing.*

| PARAMETER    |  | TEST CONDITIONS  | MIN    | TYP | MAX  | UNIT             |
|--------------|--|--|--------|-----|------|------------------|
| $V_{IN}$     | Operating input voltage range                                | $V_{OUT} = 3.3\text{ V}$ , $I_{OUT} = 0\text{ A}$  | 3.8    |     | 36   | V                |
| $V_{OUT}$    | Output voltage regulation for $V_{OUT} = 5\text{ V}^{(1)}$   | $V_{OUT} = 5\text{ V}$ , $V_{IN} = 7\text{ V}$ to $36\text{ V}$ , $I_{OUT} = 0\text{ A}$ to max. load          | - 1.5% |     | 2.5% |                  |
|              |  | $V_{OUT} = 5\text{ V}$ , $V_{IN} = 7\text{ V}$ to $36\text{ V}$ , $I_{OUT} = 1\text{ A}$ to max. load          | - 1.5% |     | 1.5% |                  |
|              | Output voltage regulation for $V_{OUT} = 3.3\text{ V}^{(1)}$ | $V_{OUT} = 3.3\text{ V}$ , $V_{IN} = 3.8\text{ V}$ to $36\text{ V}$ , $I_{OUT} = 0\text{ A}$ to max. load      | - 1.5% |     | 2.5% |                  |
|              |  | $V_{OUT} = 3.3\text{ V}$ , $V_{IN} = 3.8\text{ V}$ to $36\text{ V}$ , $I_{OUT} = 1\text{ A}$ to max. load      | - 1.5% |     | 1.5% |                  |
| $I_{SUPPLY}$ | Input supply current when in regulation                      | $V_{IN} = 12\text{ V}$ , $V_{OUT} = 3.3\text{ V}$ , $I_{OUT} = 0\text{ A}$ ,<br>$R_{FBT} = 1\text{ M}\Omega$   |        | 25  |      | $\mu\text{A}$    |
| $V_{DROP}$   | Dropout voltage; ( $V_{IN} - V_{OUT}$ )                      | $V_{OUT} = 5\text{ V}$ , $I_{OUT} = 1\text{ A}$<br>Dropout at - 1% of regulation,<br>$f_{SW} = 140\text{ kHz}$ |        | 150 |      | mV               |
| $D_{MAX}$    | Maximum switch duty cycle <sup>(2)</sup>                     | $V_{IN} = V_{OUT} = 12\text{ V}$ , $I_{OUT} = 1\text{ A}$  |        | 98% |      |                  |
| $V_{HC}$     | FB pin voltage required to trip short-circuit hiccup mode    |  |        | 0.4 |      | V                |
| $t_{HC}$     | Time between current-limit hiccup burst                      |  |        | 94  |      | ms               |
| $t_D$        | Switch voltage dead time                                     |  |        | 2   |      | ns               |
| $T_{SD}$     | Thermal shutdown temperature                                 | Shutdown temperature   |        | 165 |      | $^\circ\text{C}$ |
|              |  | Recovery temperature   |        | 148 |      | $^\circ\text{C}$ |

(1) Deviation is with respect to  $V_{IN} = 12\text{ V}$ ,  $I_{OUT} = 1\text{ A}$ .

(2) In dropout the switching frequency drops to increase the effective duty cycle. The lowest frequency is clamped at approximately:  $f_{MIN} = 1 / (t_{ON-MAX} + t_{OFF-MIN})$ .  $D_{MAX} = t_{ON-MAX} / (t_{ON-MAX} + t_{OFF-MIN})$ .

## 6.8 Typical Characteristics

Unless otherwise specified the following conditions apply:  $T_A = 25^\circ\text{C}$  and  $V_{IN} = 12\text{ V}$



图 6-1. Non-Switching Input Supply Current



图 6-2. Shutdown Supply Current

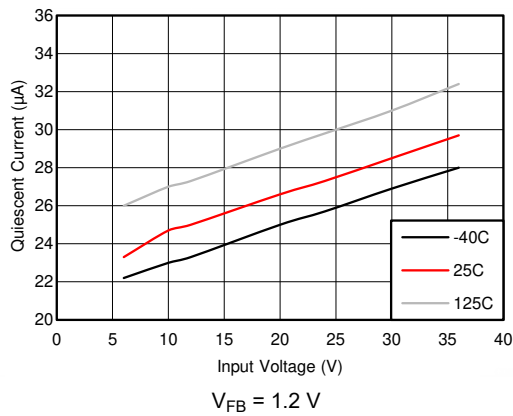

图 6-3. Short-Circuit Output Current

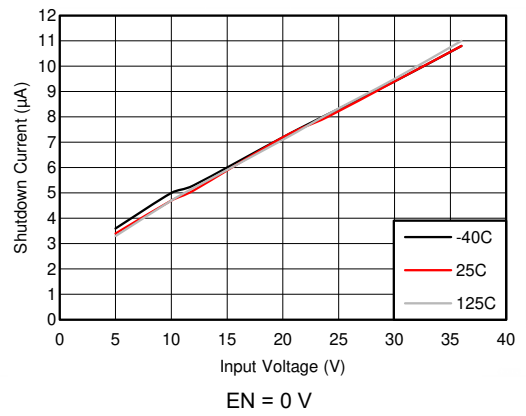

图 6-4. Precision Enable Thresholds

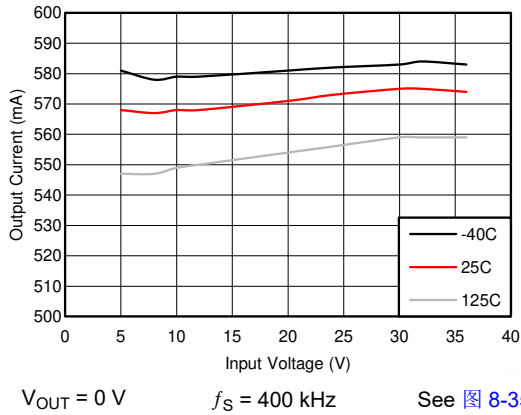

图 6-5. UVLO Thresholds

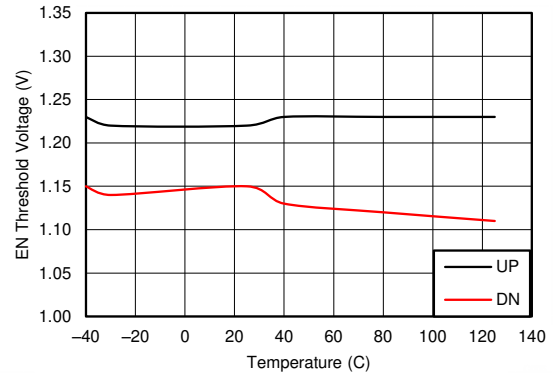

图 6-6. I<sub>PEAK-MIN</sub>

## 7 Detailed Description

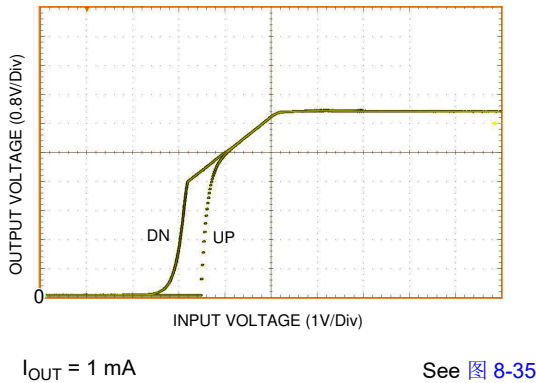
### 7.1 Overview

The LMR33620-Q1 is a synchronous peak-current-mode buck regulator designed for a wide variety of automotive applications. Advanced high speed circuitry allows the device to regulate from an input voltage of 20 V, while providing an output voltage of 3.3 V at a switching frequency of 2.1 MHz. The innovative architecture allows the device to regulate a 3.3-V output from an input of only 3.8 V. The regulator automatically switches modes between PFM and PWM depending on load. At heavy loads, the device operates in PWM at a constant switching frequency. At light loads, the mode changes to PFM with diode emulation allowing DCM. This reduces the input supply current and keeps efficiency high. The device features internal loop compensation which reduces design time and requires fewer external components than externally compensated regulators.

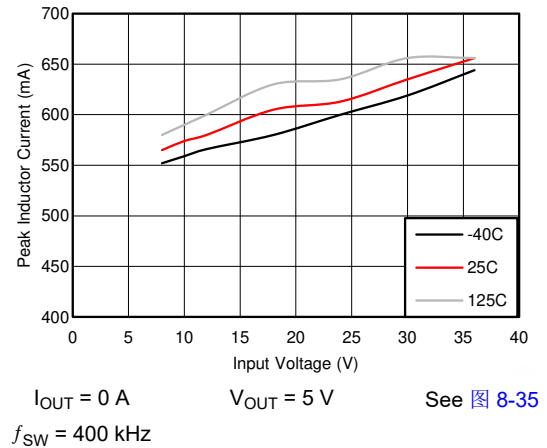
The LMR33620-Q1 is available in an ultra-miniature VQFN package with wettable flanks. This package features extremely small parasitic inductance and resistance, enabling very high efficiency while minimizing switch node ringing and dramatically reducing EMI. The VIN/PGND pin layout is symmetrical on either side of the VQFN package. This allows the input current magnetic fields to partially cancel, resulting in reduce EMI generation.

### 7.2 Functional Block Diagram

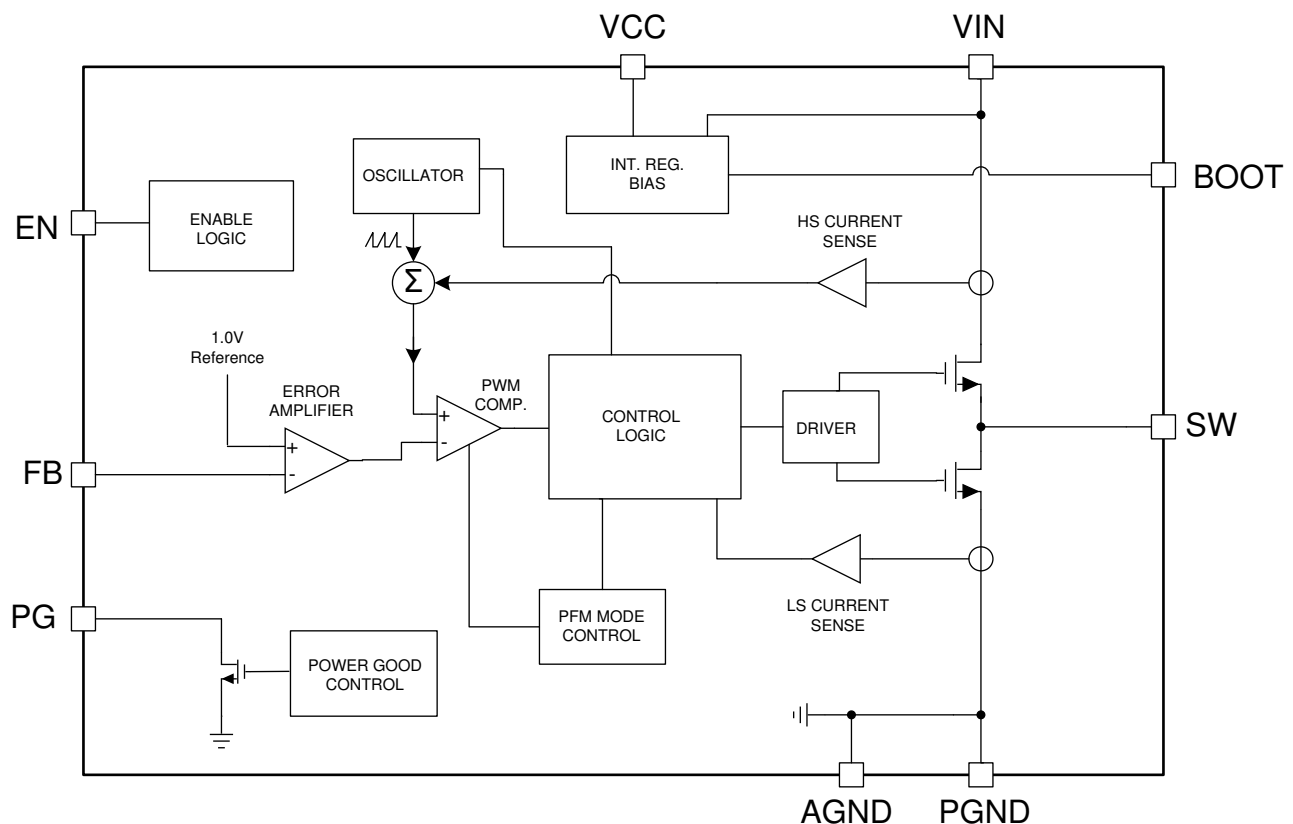

## 7.3 Feature Description

### 7.3.1 Power-Good Flag Output

The power-good flag function (PG output pin) of the LMR33620-Q1 can be used to reset a system microprocessor whenever the output voltage is out of regulation. This open-drain output goes low under fault conditions, such as current limit and thermal shutdown, as well as during normal start-up. A glitch filter prevents false flag operation for short excursions of the output voltage, such as during line and load transients. The timing parameters of the glitch filter are found in [§ 6.5](#). Output voltage excursions lasting less than  $t_{PG}$  do not trip the power-good flag. Power-good operation can best be understood by reference to [图 7-1](#) and [图 7-2](#). Note that during initial power up, a delay of about 4 ms (typical) is inserted from the time that EN is asserted to the time that the power-good flag goes high. This delay only occurs during start-up and is not encountered during normal operation of the power-good function.

The power-good output consists of an open-drain NMOS, requiring an external pullup resistor to a suitable logic supply. It can also be pulled up to either  $V_{CC}$  or  $V_{OUT}$ , through a 100-k $\Omega$  resistor, as desired. If this function is not needed, the PG pin must be left floating. When EN is pulled low, the flag output is also forced low. With EN low, power good remains valid as long as the input voltage is  $\geq 2$  V (typical). Limit the current into the power-good flag pin to less than 5 mA D.C. The maximum current is internally limited to about 35 mA when the device is enabled and about 65 mA when the device is disabled. The internal current limit protects the device from any transient currents that can occur when discharging a filter capacitor connected to this output.



图 7-1. Static Power-Good Operation



图 7-2. Power-Good-Timing Behavior

### 7.3.2 Enable and Start-up

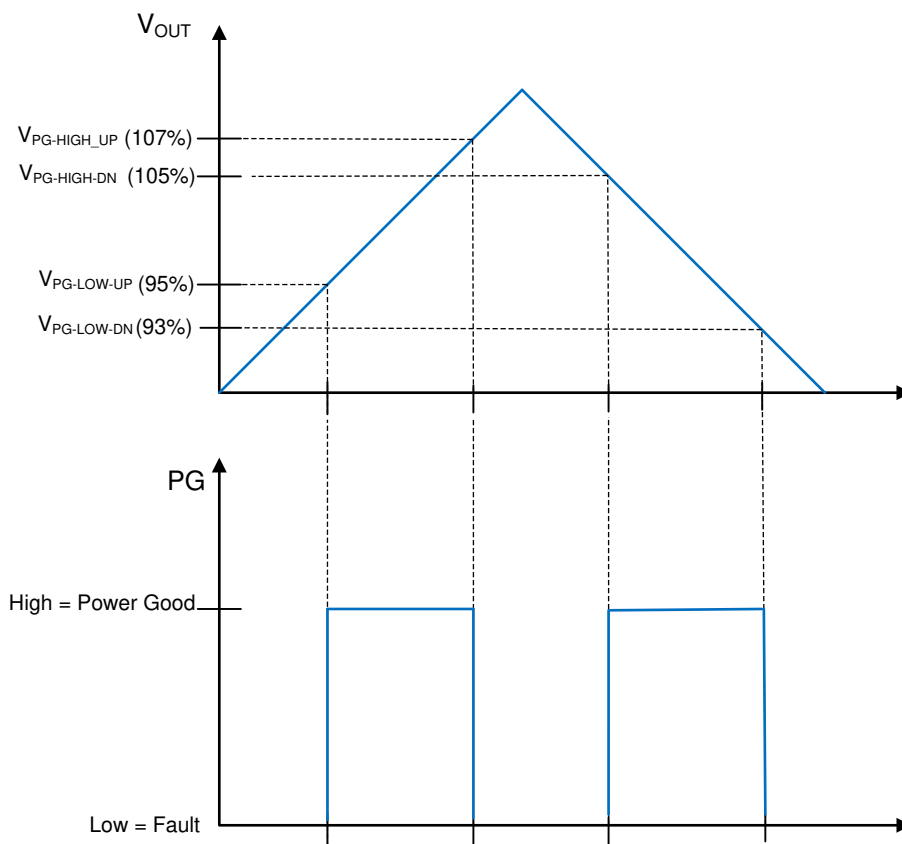
Start-up and shutdown are controlled by the EN input. This input features precision thresholds, allowing the use of an external voltage divider to provide an adjustable input UVLO (see § 8.2.2.10). Applying a voltage of  $\geq V_{EN-VCC\_H}$  causes the device to enter standby mode, powering the internal VCC, but not producing an output voltage. Increasing the EN voltage to  $V_{EN-H}$  fully enables the device, allowing it to enter start-up mode and start the soft-start period. When the EN input is brought below  $V_{EN-H}$  by  $V_{EN-HYS}$ , the regulator stops running and enters standby mode. Further decrease in the EN voltage to below  $V_{EN-VCC-L}$  completely shuts down the device. This behavior is shown in 图 7-3. The EN input can be connected directly to VIN if this feature is not needed. This input must not be allowed to float. The values for the various EN thresholds can be found in § 6.5.

The LMR33620-Q1 uses a reference-based soft start that prevents output voltage overshoots and large inrush currents as the regulator is starting up. A typical start-up waveform is shown in 图 7-4, indicating typical timings. The rise time of the output voltage is about 4 ms (see the § 6.5).

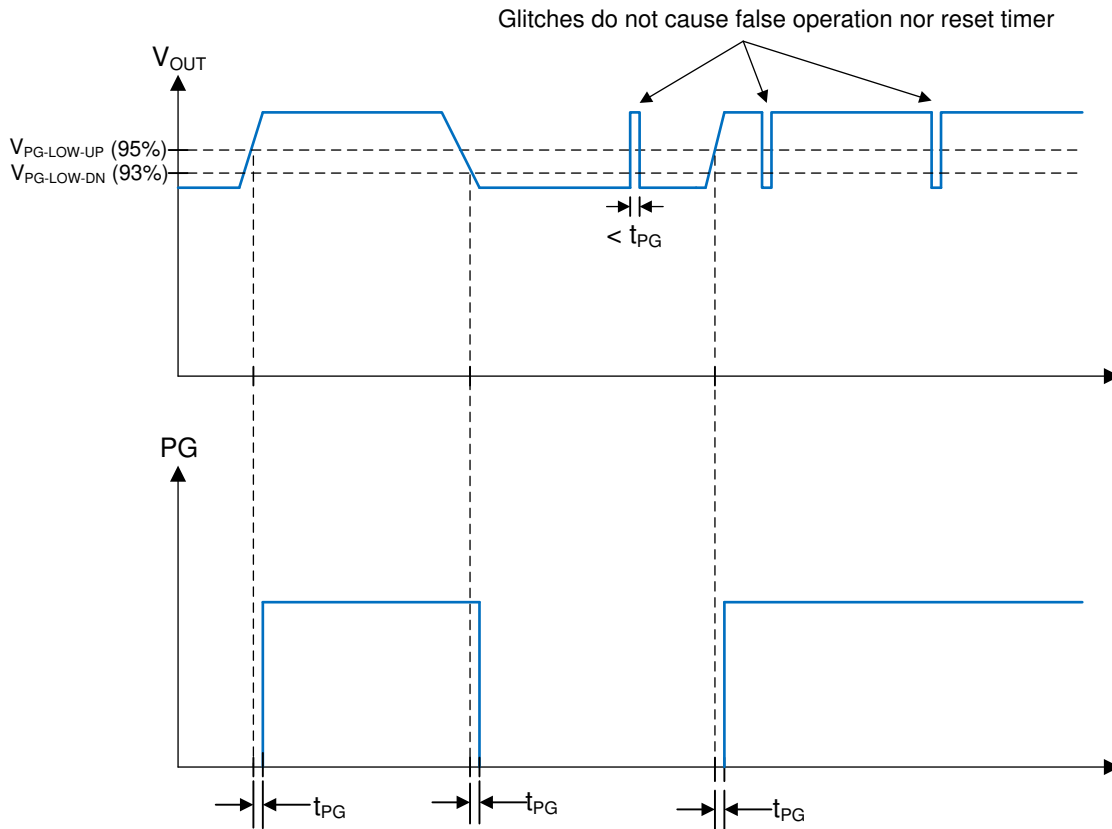

图 7-3. Precision Enable Behavior

图 7-4. Typical Start-up Behavior  $V_{IN} = 12\text{ V}$ ,  $V_{OUT} = 5\text{ V}$ ,  $I_{OUT} = 2\text{ A}$ 

### 7.3.3 Current Limit and Short Circuit

The LMR33620-Q1 incorporates both peak and valley inductor current limit to provide protection to the device from overloads and short circuits and limit the maximum output current. Valley current limit prevents inductor current runaway during short circuits on the output, while both peak and valley limits work together to limit the maximum output current of the converter. Cycle-by-cycle current limit is used for overloads, while hiccup mode is used for sustained short circuits. Finally, a zero current detector is used on the low-side power MOSFET to implement DEM at light loads (see the [Glossary](#)). The typical value of this current limit is found under  $I_{ZC}$  in [§ 6.5](#).

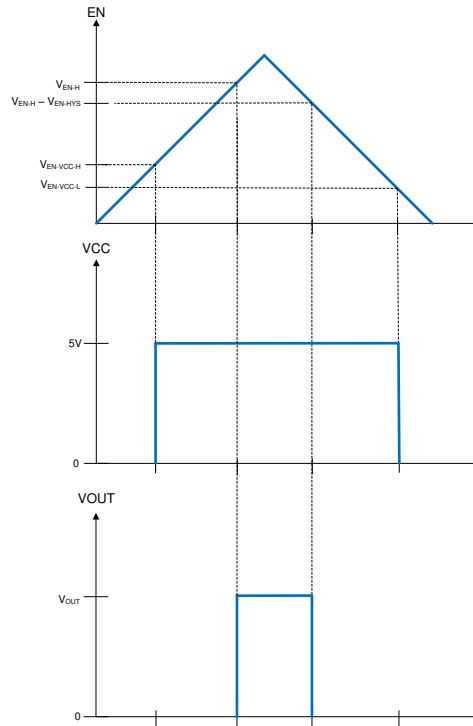
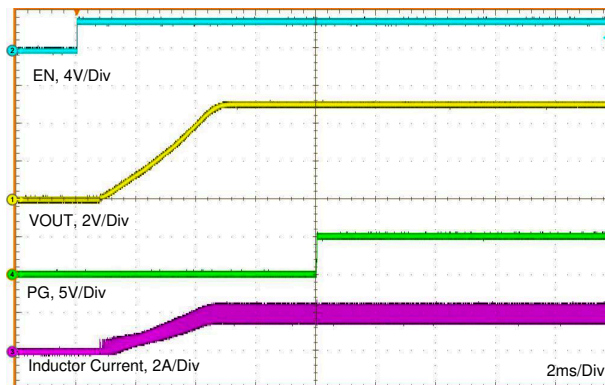
When the device is overloaded, the valley of the inductor current may not reach below  $I_{LIMIT}$  (see [§ 6.5](#)) before the next clock cycle. When this occurs, the valley current limit control skips that cycle, causing the switching frequency to drop. Further overload causes the switching frequency to continue to drop, and the inductor ripple current to increase. When the peak of the inductor current reaches the high-side current limit,  $I_{SC}$  (see [§ 6.5](#)),

the switch duty cycle is reduced and the output voltage falls out of regulation. This represents the maximum output current from the converter and is given approximately by 方程式 1.

$$I_{OUT}|_{max} = \frac{I_{LIMIT} + I_{SC}}{2} \quad (1)$$

If, during current limit, the voltage on the FB input falls below about 0.4 V due to a short circuit, the device enters hiccup mode. In this mode, the device stops switching for  $t_{HC}$  (see 节 6.7), or about 94 ms and then goes through a normal re-start with soft start. If the short-circuit condition remains, the device runs in current limit for about 20 ms (typical) and then shuts down again. This cycle repeats, as shown in 图 7-5 as long as the short-circuit-condition persists. This mode of operation helps reduce the temperature rise of the device during a hard short on the output. The output current is greatly reduced during hiccup mode. Once the output short is removed and the hiccup delay is passed, the output voltage recovers normally as shown in 图 7-6.



图 7-5. Inductor Current Burst in Short-Circuit Mode



图 7-6. Short-Circuit Transient and Recovery

### 7.3.4 Undervoltage Lockout and Thermal Shutdown

The LMR33620-Q1 incorporates an undervoltage-lockout feature on the output of the internal LDO (at the VCC pin). When VCC reaches about 3.7 V, the device is ready to receive an EN signal and start up. When VCC falls below about 3 V, the device shuts down, regardless of EN status. Because the LDO is in dropout during these transitions, the above values roughly represent the input voltage levels during the transitions.

Thermal shutdown is provided to protect the regulator from excessive junction temperature. When the junction temperature reaches about 165°C, the device shuts down; re-start occurs when the temperature falls to about 148°C.

## 7.4 Device Functional Modes

### 7.4.1 Auto Mode

In auto mode, the device moves between PWM and PFM as the load changes. At light loads, the regulator operates in PFM. At higher loads, the mode changes to PWM. The load current for which the device moves from PFM to PWM can be found in 节 8.2.3. The output current at which the device changes modes depends on the input voltage, inductor value, and the nominal switching frequency. For output currents above the curve, the device is in PWM mode. For currents below the curve, the device is in PFM. The curves apply for a nominal switching frequency of 400 kHz and the BOM shown in 表 8-3. At higher switching frequencies, the load at which the mode change occurs is greater. For applications where the switching frequency must be known for a given condition, the transition between PFM and PWM must be carefully tested before the design is finalized.

In PWM mode, the regulator operates as a constant frequency converter using PWM to regulate the output voltage. While operating in this mode, the output voltage is regulated by switching at a constant frequency and

modulating the duty cycle to control the power to the load. This provides excellent line and load regulation and low output voltage ripple.

In PFM, the high-side MOSFET is turned on in a burst of one or more pulses to provide energy to the load. The duration of the burst depends on how long it takes the inductor current to reach  $I_{PEAK-MIN}$ . The periodicity of these bursts is adjusted to regulate the output, while diode emulation (DEM) is used to maximize efficiency (see the [Glossary](#)). This mode provides high light-load efficiency by reducing the amount of input supply current required to regulate the output voltage at light loads. PFM results in very good light-load efficiency, but also yields larger output voltage ripple and variable switching frequency. Also, a small increase in output voltage occurs at light loads. The actual switching frequency and output voltage ripple depends on the input voltage, output voltage, and load. Typical switching waveforms in PFM and PWM are shown in [图 7-7](#) and [图 7-8](#).

See [# 8.2.3](#) for output voltage variation with load in auto mode.

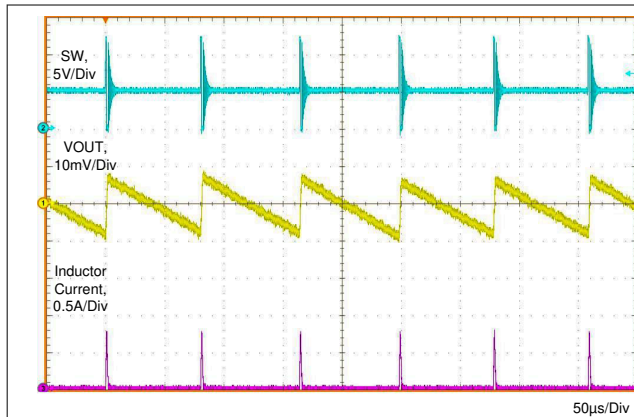

**图 7-7. Typical PFM Switching Waveforms  $V_{IN} = 12$  V,  $V_{OUT} = 5$  V,  $I_{OUT} = 10$  mA**

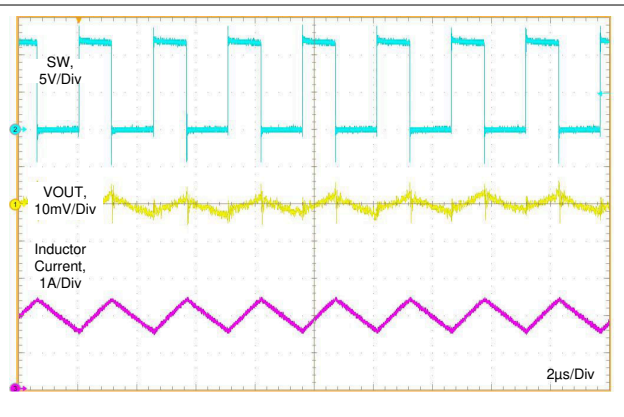

**图 7-8. Typical PWM Switching Waveforms  $V_{IN} = 12$  V,  $V_{OUT} = 5$  V,  $I_{OUT} = 2$  A,  $f_S = 400$  kHz**

## 7.4.2 Dropout

The dropout performance of any buck regulator is affected by the  $R_{DS(ON)}$  of the power MOSFETs, the DC resistance of the inductor, and the maximum duty cycle that the controller can achieve. As the input voltage level approaches the output voltage, the off-time of the high-side MOSFET starts to approach the minimum value (see [# 6.6](#)). Beyond this point, the switching can become erratic, and the output voltage falls out of regulation. To avoid this problem, the LMR33620-Q1 automatically reduces the switching frequency to increase the effective duty cycle and maintain regulation. In this data sheet, the dropout voltage is defined as the difference between the input and output voltage when the output has dropped by 1% of its nominal value. Under this condition, the switching frequency has dropped to its minimum value of about 140 kHz. Note that the 0.4 V short circuit detection threshold is not activated when in dropout mode. Typical dropout characteristics can be found in [图 7-9](#), [图 7-10](#), [图 7-11](#), and [图 7-12](#).





图 7-9. Overall Dropout Characteristic  $V_{OUT} = 5\text{ V}$



图 7-10. Typical Dropout Voltage versus Output Current in Frequency Foldback  $f_{SW} = 140\text{ kHz}$

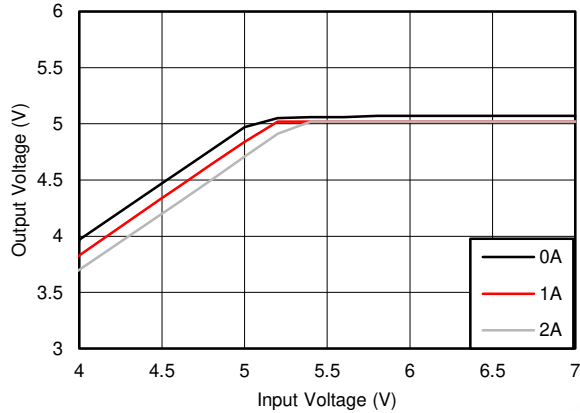

图 7-11. Typical Switching Frequency in Dropout Mode  $V_{OUT} = 3.3\text{ V}$ ,  $f_{SW} = 2.1\text{ MHz}$

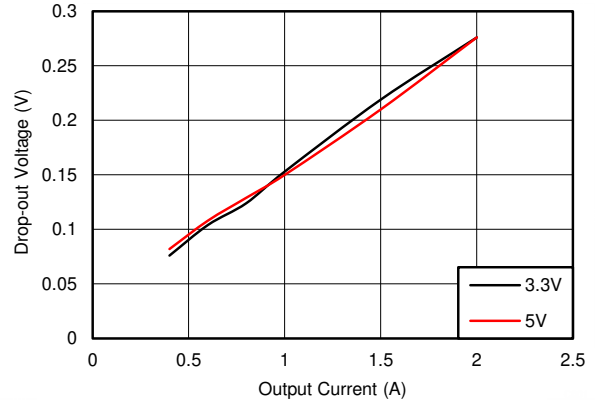

图 7-12. Typical Switching Frequency in Dropout Mode  $V_{OUT} = 5\text{ V}$ ,  $f_{SW} = 2.1\text{ MHz}$

### 7.4.3 Minimum Switch On-Time

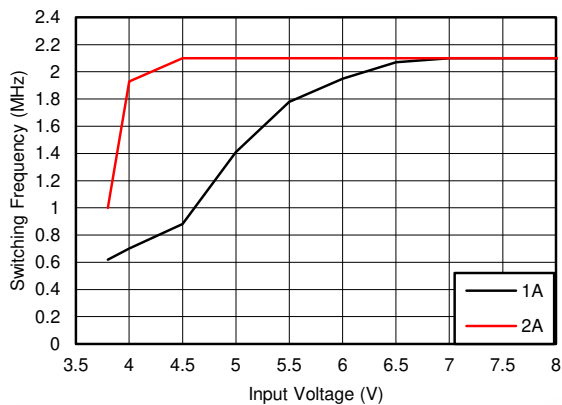
Every switching regulator has a minimum controllable on-time dictated by the inherent delays and blanking times associated with the control circuits. This imposes a minimum switch duty cycle and, therefore, a minimum conversion ratio. The constraint is encountered at high input voltages and low output voltages. To help extend the minimum controllable duty cycle, the LMR33620-Q1 automatically reduces the switching frequency when the minimum on-time limit is reached. This way the converter can regulate the lowest programmable output voltage at the maximum input voltage. An estimate for the approximate input voltage, for a given output voltage, before frequency foldback occurs is found in 方程式 2. The values of  $t_{ON}$  and  $f_{SW}$  can be found in 节 6.5. As the input voltage is increased, the switch on-time (duty-cycle) reduces to regulate the output voltage. When the on-time reaches the limit, the switching frequency drops, while the on-time remains fixed. This relationship is highlighted in 图 7-13 for a nominal switching frequency of 2.1 MHz.

$$V_{IN} \leq \frac{V_{OUT}}{t_{ON} \cdot f_{SW}} \quad (2)$$

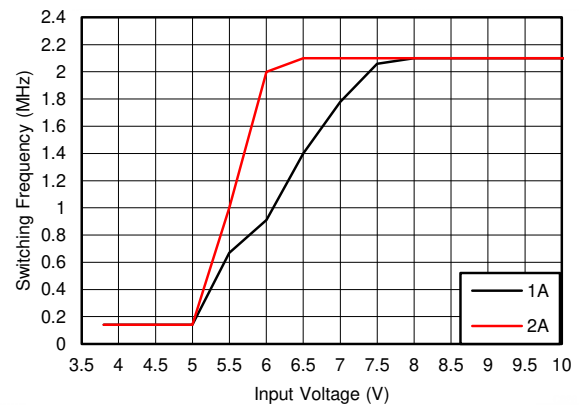

图 7-13. Switching Frequency versus Input Voltage  $V_{OUT} = 3.3\text{ V}$

## 8 Application and Implementation

### 备注

以下应用部分的信息不属于 TI 组件规范，TI 不担保其准确性和完整性。客户应负责确定 TI 组件是否适用于其应用。客户应验证并测试其设计，以确保系统功能。

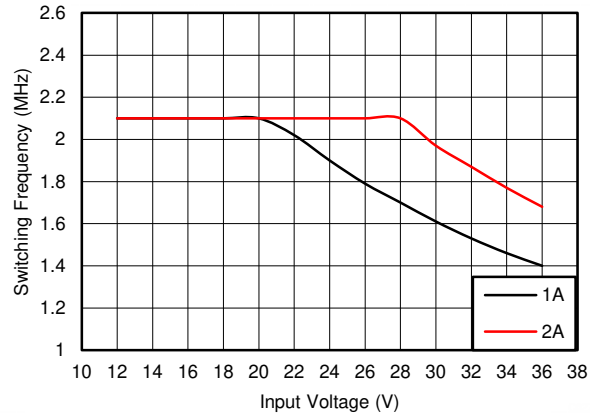
### 8.1 Application Information

The LMR33620-Q1 step-down DC-to-DC converter is typically used to convert a higher DC voltage to a lower DC voltage with a maximum output current of 2 A. The following design procedure can be used to select components for the LMR33620-Q1. Alternately, the WEBENCH Design Tool can be used to generate a complete design. This tool utilizes an iterative design procedure and has access to a comprehensive database of components. This allows the tool to create an optimized design and allows the user to experiment with various options.

### 备注

In this data sheet, the *effective* value of capacitance is defined as the actual capacitance under D.C. bias and temperature; not the rated or nameplate values. Use high-quality, low-ESR, ceramic capacitors with an X5R or better dielectric throughout. All high value ceramic capacitors have a large voltage coefficient in addition to normal tolerances and temperature effects. Under D.C. bias the capacitance drops considerably. Large case sizes and/or higher voltage ratings are better in this regard. To help mitigate these effects, multiple capacitors can be used in parallel to bring the minimum *effective* capacitance up to the required value. This can also ease the RMS current requirements on a single capacitor. A careful study of bias and temperature variation of any capacitor bank should be made in order to ensure that the minimum value of *effective* capacitance is provided.

### 8.2 Typical Application

图 8-1 shows a typical application circuit for the LMR33620-Q1. This device is designed to function over a wide range of external components and system parameters. However, the internal compensation is optimized for a certain range of external inductance and output capacitance. As a quick start guide, 图 8-1 provide typical component values for a range of the most common output voltages. The values given in the table are typical. Other values can be used to enhance certain performance criterion as required by the application. When using the fixed output voltage version, connect the FB input directly to  $V_{OUT}$ . Note that for the VQFN package, the input capacitors are split and placed on either side of the package; see 节 8.2.2.6 for more details.



图 8-1. Example Application Circuit (400 kHz)

## 8.2.1 Design Requirements

表 8-1 provides the parameters for our detailed design procedure example:

表 8-1. Detailed Design Parameters

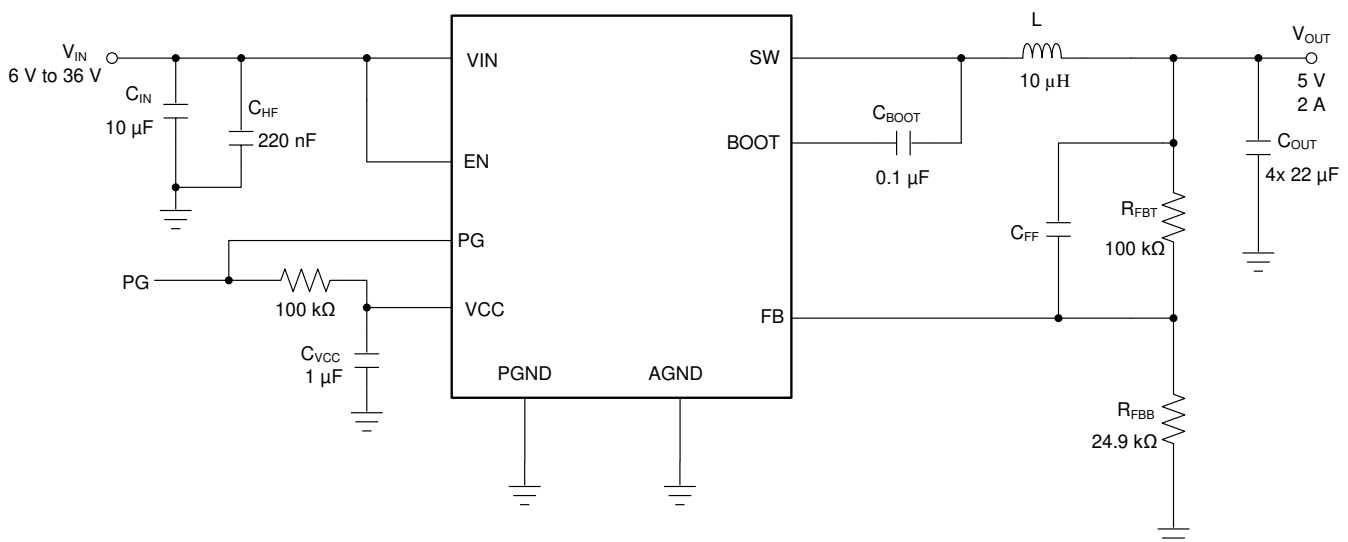
| DESIGN PARAMETER       | EXAMPLE VALUE      |
|------------------------|--------------------|
| Input voltage          | 12 V (6 V to 36 V) |
| Output voltage         | 5 V                |
| Maximum output current | 0 A to 2 A         |
| Switching frequency    | 400 kHz            |

表 8-2. Typical External Component Values

| $f_{sw}$<br>(kHz) | $V_{OUT}$ (V) | L ( $\mu$ H) | $C_{OUT}$ (RATED<br>CAPACITANCE) | $R_{FBT}$ ( $\Omega$ ) | $R_{FBB}$ ( $\Omega$ ) | $C_{IN} + C_{HF}$   | $C_{BOOT}$ | $C_{VCC}$ | $C_{FF}$ |
|-------------------|---------------|--------------|----------------------------------|------------------------|------------------------|---------------------|------------|-----------|----------|
| 400               | 3.3           | 10           | 4 × 22 $\mu$ F                   | 100 k                  | 43.2 k                 | 10 $\mu$ F + 220 nF | 100 nF     | 1 $\mu$ F | open     |
| 1400              | 3.3           | 2.2          | 2 × 22 $\mu$ F                   | 100 k                  | 43.2 k                 | 10 $\mu$ F + 220 nF | 100 nF     | 1 $\mu$ F | open     |
| 2100              | 3.3           | 1.2          | 2 × 22 $\mu$ F                   | 100 k                  | 43.2 k                 | 10 $\mu$ F + 220 nF | 100 nF     | 1 $\mu$ F | open     |
| 400               | 5             | 10           | 4 × 22 $\mu$ F                   | 100 k                  | 24.9 k                 | 10 $\mu$ F + 220 nF | 100 nF     | 1 $\mu$ F | open     |
| 1400              | 5             | 2.2          | 2 × 22 $\mu$ F                   | 100 k                  | 24.9 k                 | 10 $\mu$ F + 220 nF | 100 nF     | 1 $\mu$ F | open     |
| 2100              | 5             | 1.5          | 2 × 22 $\mu$ F                   | 100 k                  | 24.9 k                 | 10 $\mu$ F + 220 nF | 100 nF     | 1 $\mu$ F | open     |
| 400               | 12            | 27           | 4 × 22 $\mu$ F                   | 100 k                  | 9.09 k                 | 10 $\mu$ F + 220 nF | 100 nF     | 1 $\mu$ F | open     |
| 1400              | 12            | 4.7          | 4 × 10 $\mu$ F                   | 100 k                  | 9.09 k                 | 10 $\mu$ F + 220 nF | 100 nF     | 1 $\mu$ F | open     |
| 2100              | 12            | 3.3          | 4 × 10 $\mu$ F                   | 100 k                  | 9.09 k                 | 10 $\mu$ F + 220 nF | 100 nF     | 1 $\mu$ F | open     |

## 8.2.2 Detailed Design Procedure

The following design procedure applies to 图 8-1 and 表 8-1.

### 8.2.2.1 Custom Design With WEBENCH® Tools

Click [here](#) to create a custom design using the LMR33620-Q1 device with the WEBENCH® Power Designer.

1. Start by entering the input voltage ( $V_{IN}$ ), output voltage ( $V_{OUT}$ ), and output current ( $I_{OUT}$ ) requirements.
2. Optimize the design for key parameters such as efficiency, footprint, and cost using the optimizer dial.
3. Compare the generated design with other possible solutions from Texas Instruments.

The WEBENCH Power Designer provides a customized schematic along with a list of materials with real-time pricing and component availability.

In most cases, these actions are available:

- Run electrical simulations to see important waveforms and circuit performance
- Run thermal simulations to understand board thermal performance
- Export customized schematic and layout into popular CAD formats
- Print PDF reports for the design, and share the design with colleagues

Get more information about WEBENCH tools at [www.ti.com/WEBENCH](http://www.ti.com/WEBENCH).

### 8.2.2.2 Choosing the Switching Frequency

The choice of switching frequency is a compromise between conversion efficiency and overall solution size. Lower switching frequency implies reduced switching losses and usually results in higher system efficiency. However, higher switching frequency allows the use of smaller inductors and output capacitors, and hence a more compact design. For this example, 400 kHz was chosen.

### 8.2.2.3 Setting the Output Voltage

The output voltage of the LMR33620-Q1 is externally adjustable using a resistor divider network. The range of recommended output voltage is found in [§ 6.3](#). The divider network is comprised of  $R_{FBT}$  and  $R_{FBB}$ , and closes the loop between the output voltage and the converter. The converter regulates the output voltage by holding the voltage on the FB pin equal to the internal reference voltage,  $V_{REF}$ . The resistance of the divider is a compromise between excessive noise pick-up and excessive loading of the output. Smaller values of resistance reduce noise sensitivity but also reduce the light-load efficiency. The recommended value for  $R_{FBT}$  is 100 k $\Omega$ ; with a maximum value of 1 M $\Omega$ . If a 1 M $\Omega$  is selected for  $R_{FBT}$ , then a feedforward capacitor must be used across this resistor to provide adequate loop phase margin (see [§ 8.2.2.9](#)). Once  $R_{FBT}$  is selected, [方程式 3](#) is used to select  $R_{FBB}$ .  $V_{REF}$  is nominally 1 V (see [§ 6.5](#) for limits).

$$R_{FBB} = \frac{R_{FBT}}{\left[ \frac{V_{OUT}}{V_{REF}} - 1 \right]} \quad (3)$$

For this 5-V example,  $R_{FBT} = 100 \text{ k}\Omega$  and  $R_{FBB} = 24.9 \text{ k}\Omega$  are chosen.

#### 8.2.2.3.1 Fixed Output Voltage Option

With the fixed output voltage version, the feed-back divider is internal to the device. Therefore, an external divider is not needed and the FB input is connected directly to  $V_{OUT}$ . The total resistance of the internal divider is about 2 M $\Omega$  (see [§ 6.5](#)). The large value of the divider reduces the loading on the output and helps to reduce the no-load input current of the system. For those applications that require the lowest no-load input current, without resorting to large value feed-back resistors, the fixed output voltage option is a good solution. [图 8-2](#) and [图 8-3](#) show the no-load and light load input supply current for the fixed option, using the BOM from [表 8-3](#) and with  $R_{FBT} = 0 \Omega$  and  $R_{FBB} = \text{open}$ . [图 8-4](#) and [图 8-5](#) show the same characteristics for the 3.3-V fixed option.



图 8-2. No-load Input Supply Current for 5-V Fixed Output Option



图 8-3. Input Supply Current vs Output Current for 5-V Fixed Output Option

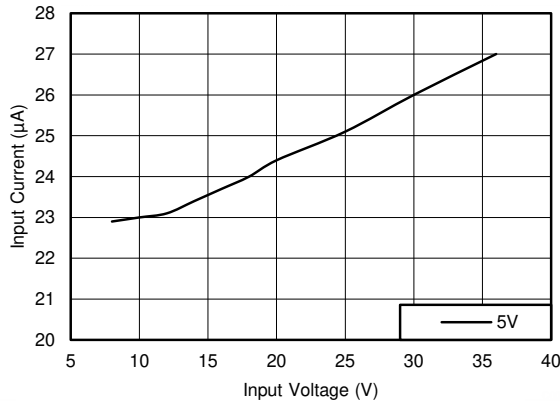

图 8-4. No-load Input Supply Current for 3.3-V Fixed Output Option

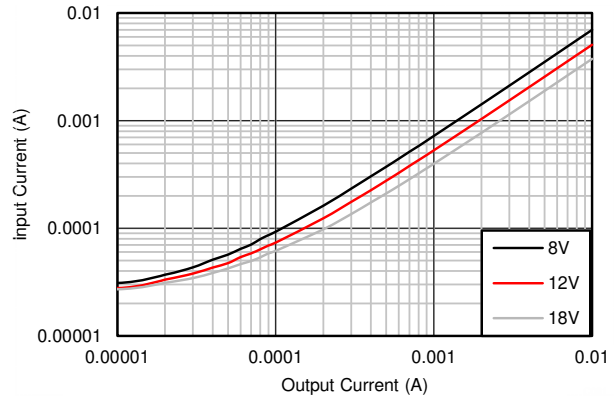

图 8-5. Input Supply Current vs Output Current for 3.3-V Fixed Output Option

### 8.2.2.4 Inductor Selection

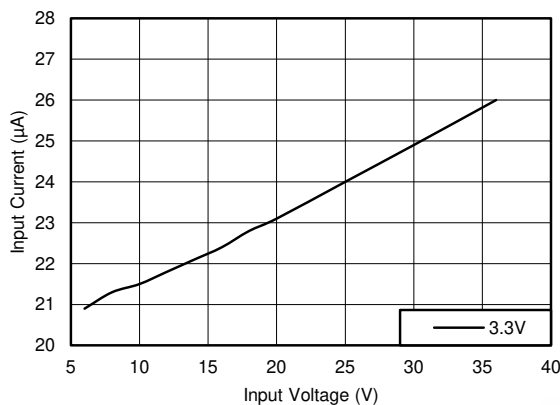
The parameters for selecting the inductor are the inductance and saturation current. The inductance is based on the desired peak-to-peak ripple current and is normally chosen to be in the range of 20% to 40% of the maximum output current. Experience shows that the best value for inductor ripple current is 30% of the maximum load current. Note that when selecting the ripple current for applications with much smaller maximum load than the maximum available from the device, the maximum device current should be used. 方程式 4 可以用于确定电感值的值。常数 K 是电感器电流纹波百分比。对于此示例，K = 0.3 被选中并找到了电感值；下一个标准值为 10 µH 被选中。

$$L = \frac{(V_{IN} - V_{OUT})}{f_{SW} \cdot K \cdot I_{OUT_{max}}} \cdot \frac{V_{OUT}}{V_{IN}} \quad (4)$$

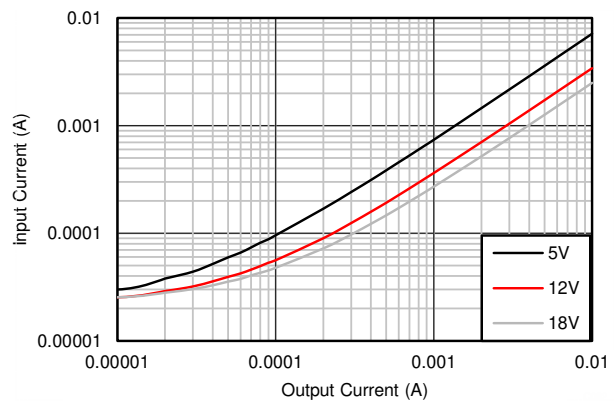
Ideally, the saturation current rating of the inductor must be at least as large as the high-side switch current limit,  $I_{SC}$  (see 节 6.5). This ensures that the inductor does not saturate even during a short circuit on the output. When the inductor core material saturates, the inductance falls to a very low value, causing the inductor current to rise very rapidly. Although the valley current limit,  $I_{LIMIT}$ , is designed to reduce the risk of current run-away, a saturated inductor can cause the current to rise to high values very rapidly. This can lead to component damage; do not allow the inductor to saturate. Inductors with a ferrite core material have very *hard* saturation characteristics, but usually have lower core losses than powdered iron cores. Powdered iron cores exhibit a *soft* saturation, allowing for some relaxation in the current rating of the inductor. However, they have more core losses at frequencies typically above 1 MHz. In any case, the inductor saturation current must not be less than the device low-side current limit,  $I_{LIMIT}$  (see the 节 6.5). The maximum inductance is limited by the minimum

current ripple required for the current mode control to perform correctly. As a rule-of-thumb, the minimum inductor ripple current must be no less than about 10% of the device maximum rated current under nominal conditions.

$$L_{\text{MIN}} \geq 0.36 \cdot \frac{V_{\text{OUT}}}{f_{\text{SW}}} \quad (5)$$

### 8.2.2.5 Output Capacitor Selection

The value of the output capacitor and the ESR of the capacitor determine the output voltage ripple and load transient performance. The output capacitor bank is usually limited by the load transient requirements, rather than the output voltage ripple. [方程式 6](#) can be used to estimate a lower bound on the total output capacitance and an upper bound on the ESR, which is required to meet a specified load transient.

$$C_{\text{OUT}} \geq \frac{\Delta I_{\text{OUT}}}{f_{\text{SW}} \cdot \Delta V_{\text{OUT}} \cdot K} \cdot \left[ (1-D) \cdot (1+K) + \frac{K^2}{12} \cdot (2-D) \right]$$

$$\text{ESR} \leq \frac{(2+K) \cdot \Delta V_{\text{OUT}}}{2 \cdot \Delta I_{\text{OUT}} \left[ 1+K + \frac{K^2}{12} \cdot \left( 1 + \frac{1}{(1-D)} \right) \right]}$$

$$D = \frac{V_{\text{OUT}}}{V_{\text{IN}}} \quad (6)$$

where

- $\Delta V_{\text{OUT}}$  = output voltage transient
- $\Delta I_{\text{OUT}}$  = output current transient
- K = ripple factor from [节 8.2.2.4](#)

Once the output capacitor and ESR have been calculated, [方程式 7](#) can be used to check the peak-to-peak output voltage ripple;  $V_r$ .

$$V_r \cong \Delta I_L \cdot \sqrt{\text{ESR}^2 + \frac{1}{(8 \cdot f_{\text{SW}} \cdot C_{\text{OUT}})^2}} \quad (7)$$

The output capacitor and ESR can then be adjusted to meet both the load transient and output ripple requirements.

For this example, a  $\Delta V_{\text{OUT}} \leq 250$  mV for an output current step of  $\Delta I_{\text{OUT}} = 2$  A is required. [方程式 6](#) gives a minimum value of 45  $\mu\text{F}$  and a maximum ESR of 0.11  $\Omega$ . Assuming a 20% tolerance and a 10% bias de-rating, you arrive at a minimum capacitance of 63  $\mu\text{F}$ . This can be achieved with a bank of 4  $\times$  22- $\mu\text{F}$ , 16-V ceramic capacitors in the 1210 case size. More output capacitance can be used to improve the load transient response. Ceramic capacitors can easily meet the minimum ESR requirements. In some cases, an aluminum electrolytic capacitor can be placed in parallel with the ceramics to help build up the required value of capacitance. In general, use a capacitor of at least 10 V for output voltages of 3.3 V or less and a capacitor of 16 V or more for output voltages of 5 V and above.

In practice, the output capacitor has the most influence on the transient response and loop phase margin. Load transient testing and Bode plots are the best way to validate any given design and must always be completed before the application goes into production. In addition to the required output capacitance, a small ceramic placed on the output can help reduce high frequency noise. Small case size ceramic capacitors in the range of 1 nF to 100 nF can be very helpful in reducing voltage spikes on the output caused by inductor and board parasitics.

The maximum value of total output capacitance must be limited to about 10 times the design value, or 1000  $\mu\text{F}$ , whichever is smaller. Large values of output capacitance can adversely affect the start-up behavior of the regulator as well as the loop stability. If values larger than noted here must be used, then a careful study of start-up at full load and loop stability must be performed.

### 8.2.2.6 Input Capacitor Selection

The ceramic input capacitors provide a low impedance source to the regulator in addition to supplying the ripple current and isolating switching noise from other circuits. A minimum of 10  $\mu\text{F}$  of ceramic capacitance is required on the input of the LMR33620-Q1. This must be rated for at least the maximum input voltage that the application requires; preferably twice the maximum input voltage. This capacitance can be increased to help reduce input voltage ripple and maintain the input voltage during load transients. In addition, a small case size, 220-nF ceramic capacitor must be used at the input, as close as possible to the regulator. This provides a high frequency bypass for the control circuits internal to the device. For this example, a 4.7- $\mu\text{F}$ , 50-V, X7R (or better) ceramic capacitor is chosen. The 220 nF must also be rated at 50 V with an X7R dielectric. The VQFN (RNx) package provides two input voltage pins and two power ground pins on opposite sides of the package. This allows the input capacitors to be split, and placed optimally with respect to the internal power MOSFETs, thus improving the effectiveness of the input bypassing. In this example, a single 4.7- $\mu\text{F}$  and two 100-nF ceramic capacitors at each VIN/PGND location.

Many times, it is desirable to use an electrolytic capacitor on the input in parallel with the ceramics. This is especially true if long leads/traces are used to connect the input supply to the regulator. The moderate ESR of this capacitor can help damp any ringing on the input supply caused by the long power leads. The use of this additional capacitor also helps with momentary voltage dips caused by input supplies with unusually high impedance.

Most of the input switching current passes through the ceramic input capacitor or capacitors. The approximate worst case RMS value of this current can be calculated from [方程式 8](#) and must be checked against the manufacturers' maximum ratings.

$$I_{\text{RMS}} \cong \frac{I_{\text{OUT}}}{2} \quad (8)$$

### 8.2.2.7 C<sub>BOOT</sub>

The LMR33620-Q1 requires a bootstrap capacitor connected between the BOOT pin and the SW pin. This capacitor stores energy that is used to supply the gate drivers for the power MOSFETs. A high-quality ceramic capacitor of 100 nF and at least 10 V is required.

### 8.2.2.8 VCC

The VCC pin is the output of the internal LDO used to supply the control circuits of the regulator. This output requires a 1- $\mu\text{F}$ , 16-V ceramic capacitor connected from VCC to GND for proper operation. In general, avoid loading this output with any external circuitry. However, this output can be used to supply the pullup for the power-good function (see [节 7.3.1](#)). A value of 100 k $\Omega$  is a good choice in this case. The nominal output voltage on VCC is 5 V; see [节 6.5](#) for limits. Do not short this output to ground or any other external voltage.

### 8.2.2.9 C<sub>FF</sub> Selection

In some cases, a feedforward capacitor can be used across R<sub>FBT</sub> to improve the load transient response or improve the loop-phase margin. This is especially true when values of R<sub>FBT</sub> > 100 k $\Omega$  are used. Large values of R<sub>FBT</sub>, in combination with the parasitic capacitance at the FB pin, can create a small signal pole that interferes with the loop stability. A C<sub>FF</sub> can help to mitigate this effect. [方程式 9](#) can be used to estimate the value of C<sub>FF</sub>. The value found with [方程式 9](#) is a starting point; use lower values to determine if any advantage is gained by the use of a C<sub>FF</sub> capacitor. The [Optimizing Transient Response of Internally Compensated DC-DC Converters with Feed-forward Capacitor Application Report](#) is helpful when experimenting with a feedforward capacitor.



$$C_{FF} < \frac{V_{OUT} \cdot C_{OUT}}{120 \cdot R_{FBT} \cdot \sqrt{\frac{V_{REF}}{V_{OUT}}}} \quad (9)$$

### 8.2.2.10 External UVLO

In some cases, an input UVLO level different than that provided internal to the device is needed. This can be accomplished by using the circuit shown in [图 8-6](#). The input voltage at which the device turns on is designated  $V_{ON}$  while the turnoff voltage is  $V_{OFF}$ . First, a value for  $R_{ENB}$  is chosen in the range of 10 k $\Omega$  to 100 k $\Omega$  and then [方程式 10](#) is used to calculate  $R_{ENT}$  and  $V_{OFF}$ .

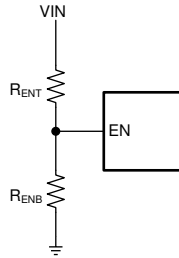

**图 8-6. Setup for External UVLO Application**

$$R_{ENT} = \left( \frac{V_{ON}}{V_{EN-H}} - 1 \right) \cdot R_{ENB}$$

$$V_{OFF} = V_{ON} \cdot \left( 1 - \frac{V_{EN-HYS}}{V_{EN-H}} \right) \quad (10)$$

where

- $V_{ON} = V_{IN}$  turnon voltage
- $V_{OFF} = V_{IN}$  turnoff voltage

### 8.2.2.11 Maximum Ambient Temperature

As with any power conversion device, the LMR33620-Q1 dissipates internal power while operating. The effect of this power dissipation is to raise the internal temperature of the converter above ambient. The internal die temperature ( $T_J$ ) is a function of the ambient temperature, the power loss, and the effective thermal resistance,  $R_{\theta JA}$ , of the device and PCB combination. The maximum internal die temperature for the LMR33620-Q1 must be limited to 125°C. This establishes a limit on the maximum device power dissipation and therefore the load current. [方程式 11](#) shows the relationships between the important parameters. It is easy to see that larger ambient temperatures ( $T_A$ ) and larger values of  $R_{\theta JA}$  reduce the maximum available output current. The converter efficiency can be estimated by using the curves provided in this data sheet. If the desired operating conditions cannot be found in one of the curves, then interpolation can be used to estimate the efficiency. Alternatively, the EVM can be adjusted to match the desired application requirements and the efficiency can be measured directly. The correct value of  $R_{\theta JA}$  is more difficult to estimate. As stated in the [Semiconductor and IC Package Thermal Metrics Application Report](#), the value of  $R_{\theta JA}$  given in [节 6.4](#) is not valid for design purposes and must not be used to estimate the thermal performance of the application. The values reported in that table were measured under a specific set of conditions that are rarely obtained in an actual application.

$$I_{OUT}|_{MAX} = \frac{(T_J - T_A)}{R_{\theta JA}} \cdot \frac{\eta}{(1 - \eta)} \cdot \frac{1}{V_{OUT}} \quad (11)$$

where

- $\eta$  = efficiency

The effective  $R_{\theta JA}$  is a critical parameter and depends on many factors such as power dissipation, air temperature/flow, PCB area, copper heat-sink area, number of thermal vias under the package, and adjacent component placement, just to mention just a few. Due to the ultra-miniature size of the VQFN (RNX) package, a DAP is not available. This means that this package exhibits a somewhat large value  $R_{\theta JA}$ . A typical example of  $R_{\theta JA}$  vs copper board area can be found in 图 8-7. The copper area given in the graph is for each layer; the top and bottom layers are 2 oz. copper each, while the inner layers are 1 oz. A typical curve of maximum output current vs. ambient temperature is shown in 图 8-8. This data was taken with a device/PCB combination giving an  $R_{\theta JA}$  of about 50°C/W. It must be remembered that the data given in these graphs are for illustration purposes only, and the actual performance in any given application depends on all of the previously mentioned factors.



图 8-7.  $R_{\theta JA}$  versus Copper Board Area for the VQFN (RNX) Package



$V_{IN} = 12\text{ V}$   $V_{OUT} = 5\text{ V}$   
 $f_{SW} = 400\text{ kHz}$   $R_{\theta JA} = 50^\circ\text{C/W}$

图 8-8. Maximum Output Current versus Ambient Temperature

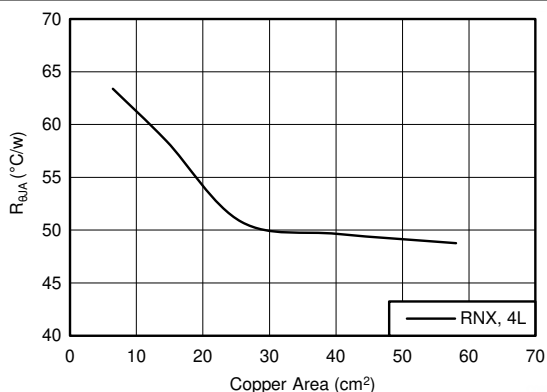
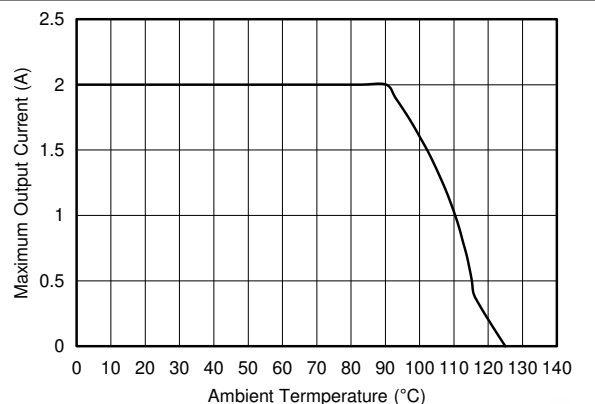
Use the following resources as a guide to optimal thermal PCB design and estimating  $R_{\theta JA}$  for a given application environment:

### 8.2.3 Application Curves

Unless otherwise specified the following conditions apply:  $V_{IN} = 12\text{ V}$ ,  $T_A = 25^\circ\text{C}$ . The circuit is shown in [图 8-35](#), with the appropriate BOM from [表 8-3](#).



图 8-9. Efficiency



图 8-10. Efficiency

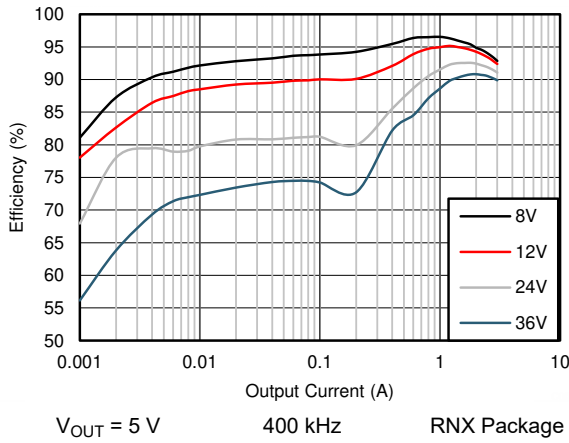

图 8-11. Efficiency

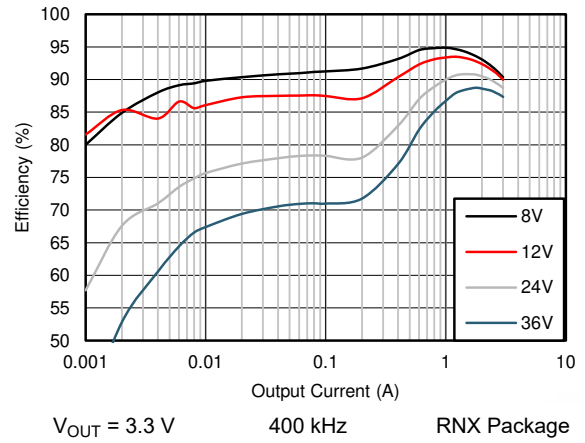

图 8-12. Efficiency

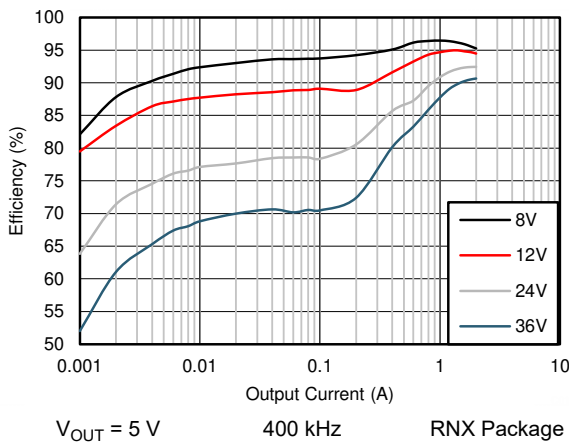

图 8-13. Efficiency

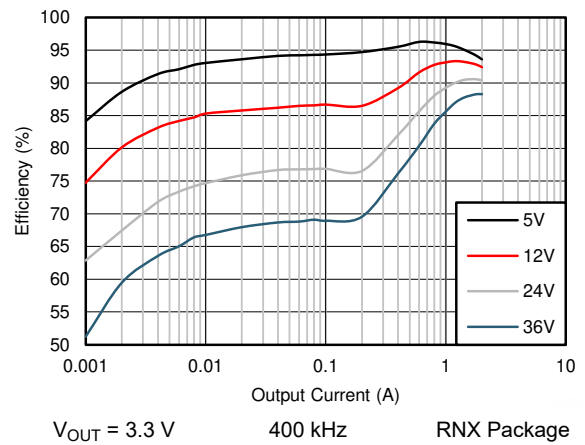

图 8-14. Efficiency

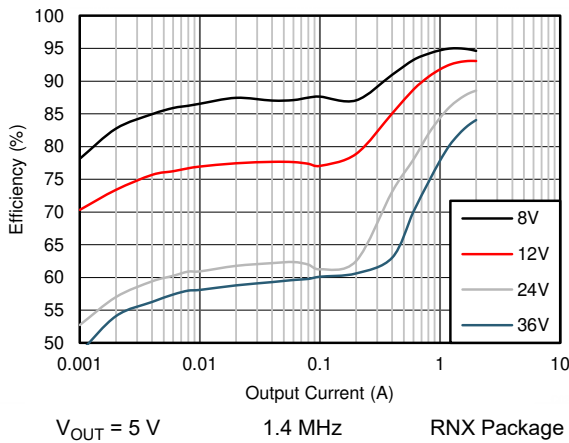

图 8-15. Efficiency

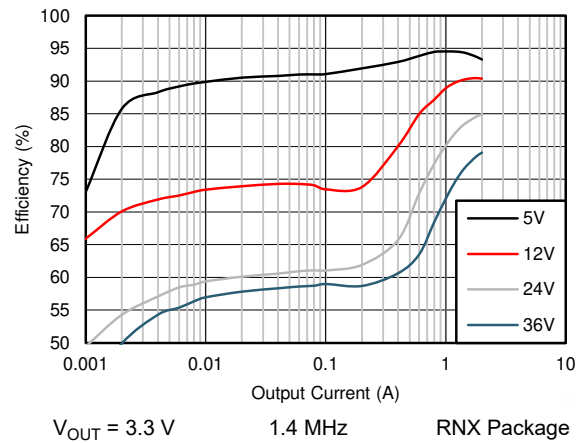

图 8-16. Efficiency

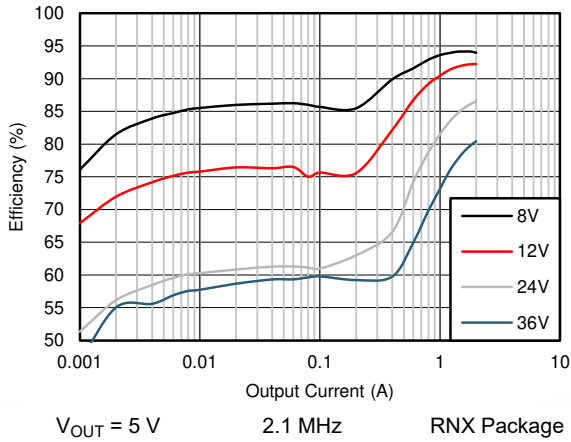

图 8-17. Line and Load Regulation

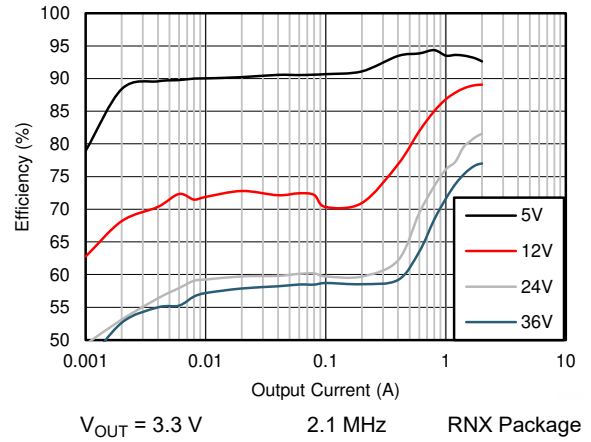

图 8-18. Input Supply Current

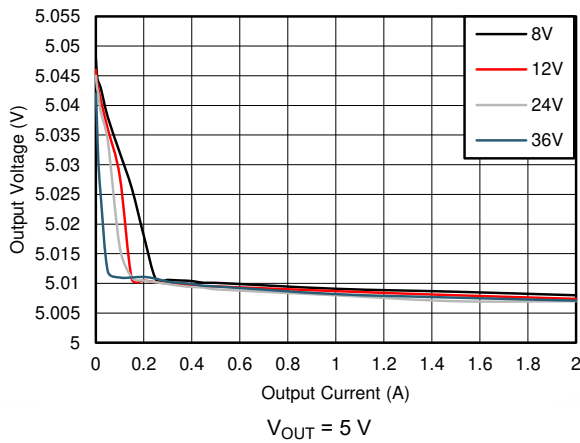

图 8-19. Mode Change Thresholds

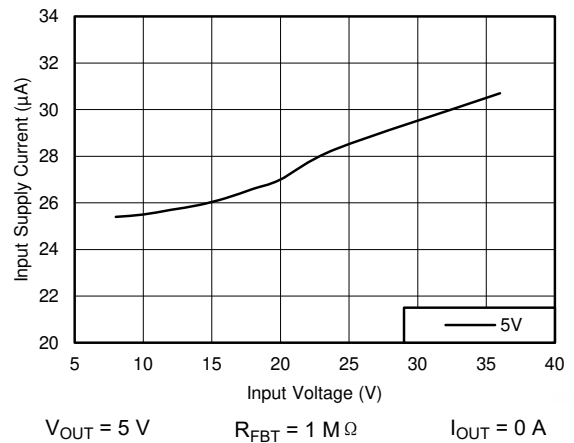

图 8-20. Switching Frequency versus Output Current

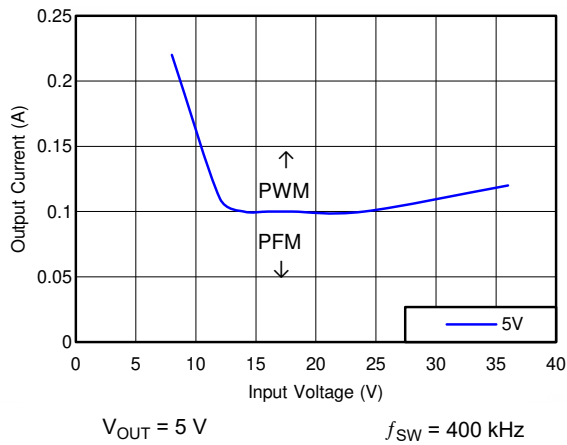

$V_{IN} = 12\text{ V}$                        $V_{OUT} = 5\text{ V}$   
 $t_f = t_r = 2\ \mu\text{s}$                        $I_{OUT} = 0\text{ A to } 2\text{ A}$

图 8-21. Load Transient

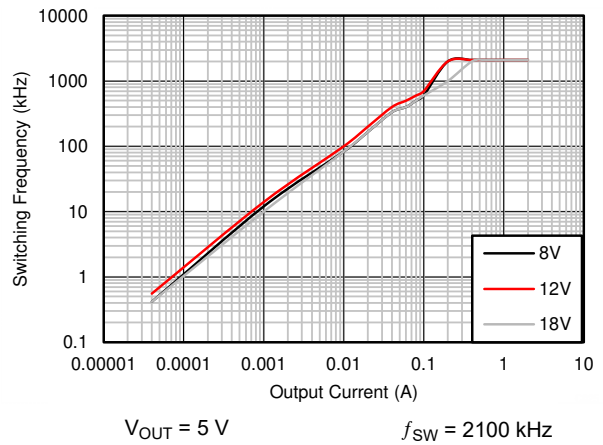
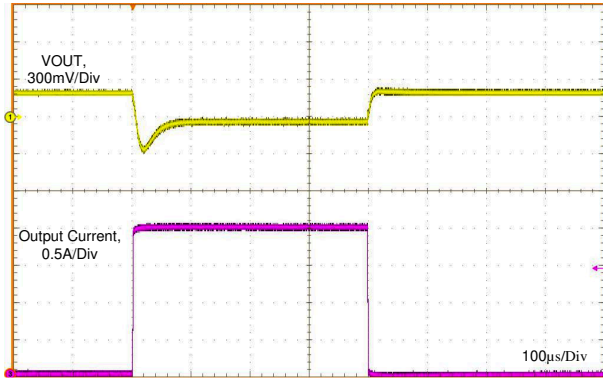
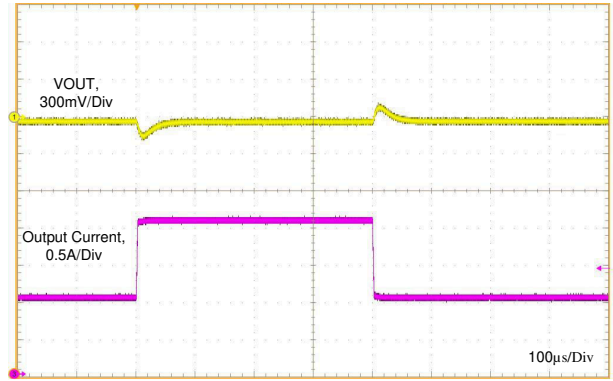

$V_{IN} = 12\text{ V}$                        $V_{OUT} = 5\text{ V}$   
 $t_f = t_r = 2\ \mu\text{s}$                        $I_{OUT} = 1\text{ A to } 2\text{ A}$

图 8-22. Load Transient



图 8-23. Line and Load Regulation



图 8-24. Input Supply Current

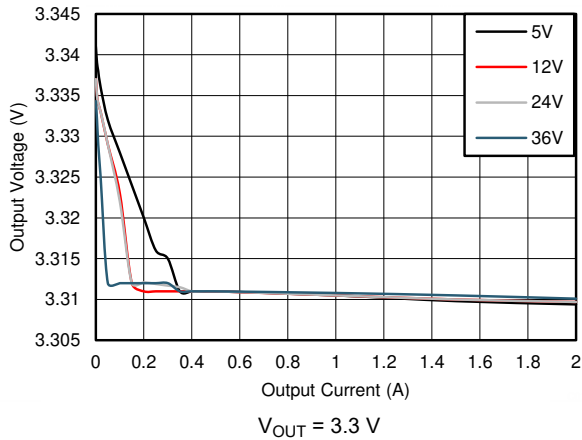

图 8-25. Mode Change Thresholds

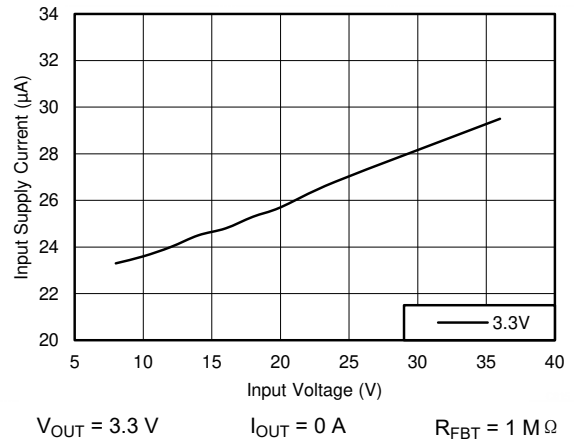

图 8-26. Switching Frequency versus Output Current

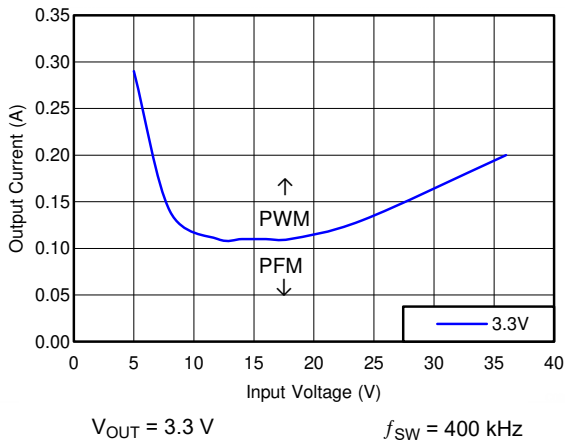

$V_{IN} = 12\text{ V}$                        $V_{OUT} = 3.3\text{ V}$   
 $t_f = t_r = 2\text{ }\mu\text{s}$                        $I_{OUT} = 0\text{ A to } 2\text{ A}$

**图 8-27. Load Transient**

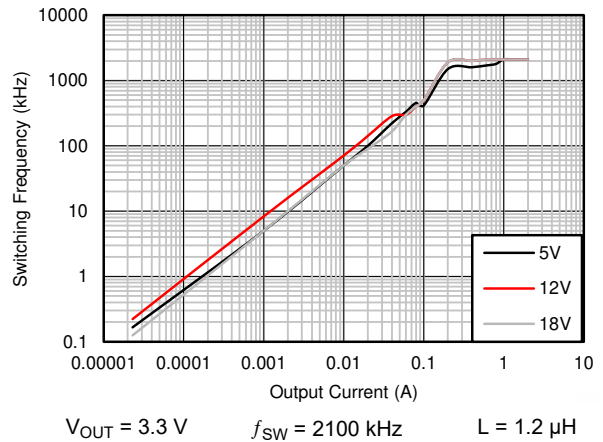
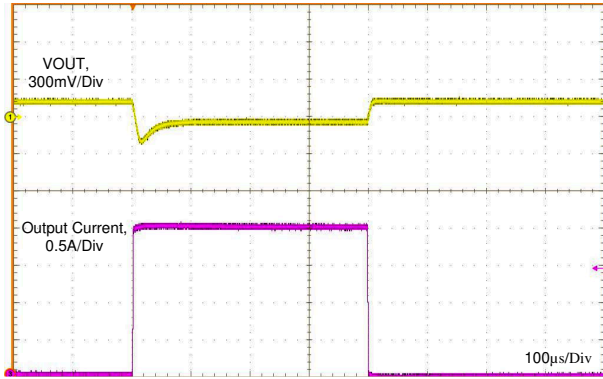
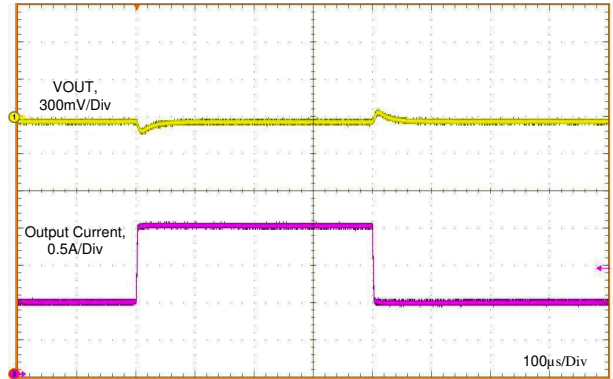

$V_{IN} = 12\text{ V}$                        $V_{OUT} = 3.3\text{ V}$                        $I_{OUT} = 1\text{ A to } 2\text{ A}$   
 $t_f = t_r = 2\text{ }\mu\text{s}$

**图 8-28. Load Transient**

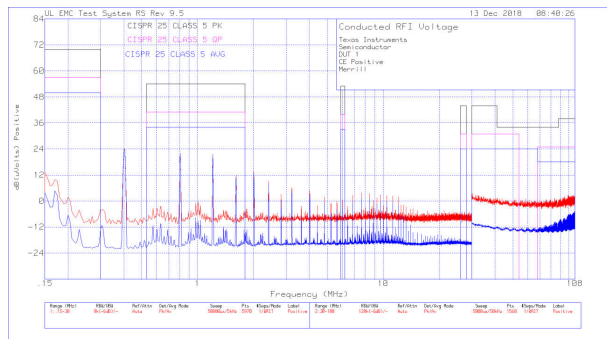

$V_{IN} = 12\text{ V}$                        $V_{OUT} = 5\text{ V}$                        $I_{OUT} = 2\text{ A}$   
 $f_{SW} = 400\text{ kHz}$                       **RNX package**

**图 8-29. Conducted EMI**

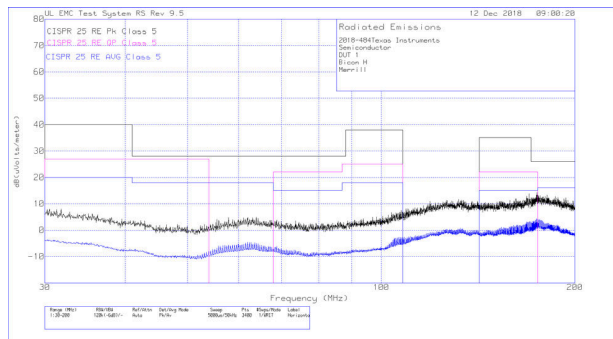

$V_{IN} = 12\text{ V}$                        $V_{OUT} = 5\text{ V}$                        $I_{OUT} = 2\text{ A}$   
 $f_{SW} = 400\text{ kHz}$                       **RNX package**

**图 8-30. Radiated EMI Biconical Antenna (Horizontal)**

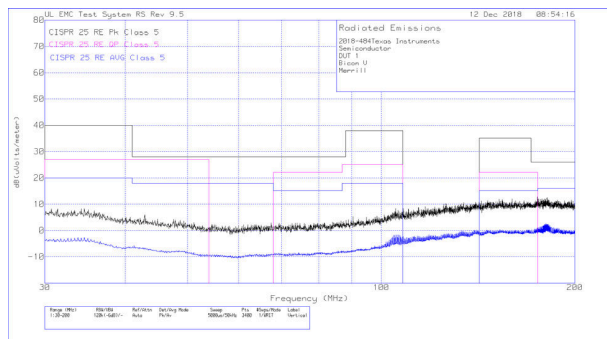

$V_{IN} = 12\text{ V}$                        $V_{OUT} = 5\text{ V}$                        $I_{OUT} = 2\text{ A}$   
 $f_{SW} = 400\text{ kHz}$                       **RNX package**

**图 8-31. Radiated EMI Biconical Antenna (Vertical)**

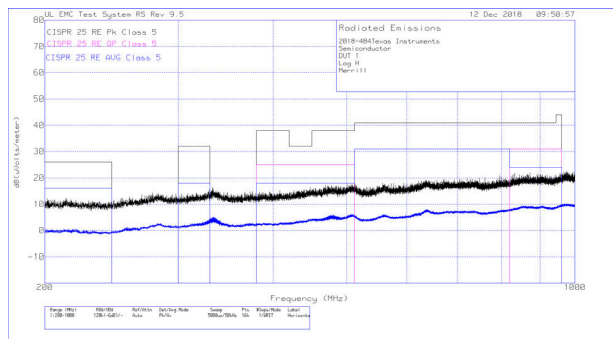

$V_{IN} = 12\text{ V}$                        $V_{OUT} = 5\text{ V}$                        $I_{OUT} = 2\text{ A}$   
 $f_{SW} = 400\text{ kHz}$                       **RNX package**

**图 8-32. Radiated EMI Log-periodic Antenna (Horizontal)**

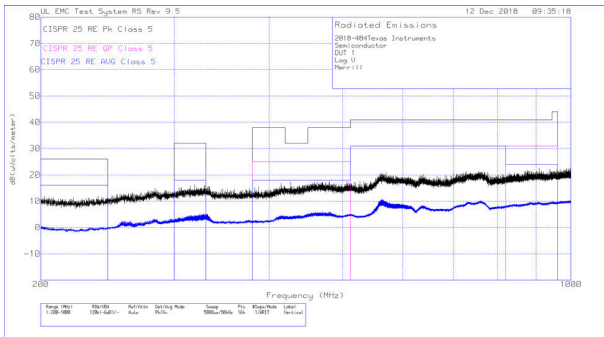

$V_{IN} = 12\text{ V}$        $V_{OUT} = 5\text{ V}$        $I_{OUT} = 2\text{ A}$   
 $f_{SW} = 400\text{ kHz}$       RNX package

**图 8-33. Radiated EMI Log-periodic Antenna (Vertical)**

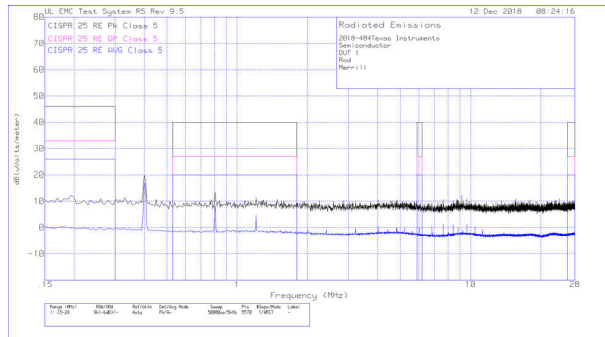

$V_{IN} = 12\text{ V}$        $V_{OUT} = 5\text{ V}$        $I_{OUT} = 2\text{ A}$   
 $f_{SW} = 400\text{ kHz}$       RNX package

**图 8-34. Radiated EMI Rod Antenna**



图 8-35. Circuit for Application Curves

表 8-3. BOM for Typical Application Curves RNX Package<sup>(1)</sup>

| V <sub>OUT</sub> | FREQUENCY | R <sub>FBB</sub> | C <sub>OUT</sub> | C <sub>IN</sub> + C <sub>HF</sub> | L               | U1           |
|------------------|-----------|------------------|------------------|-----------------------------------|-----------------|--------------|
| 3.3 V            | 400 kHz   | 43.3 kΩ          | 4 × 22 μF        | 2 × 4.7 μF + 2 × 100 nF           | 4.7 μH, 28 mΩ   | LMR33620ARNX |
| 3.3 V            | 1400 KHz  | 43.3 kΩ          | 4 × 22 μF        | 2 × 4.7 μF + 2 × 100 nF           | 2.2 μH, 11.4 mΩ | LMR33620BRNX |
| 3.3 V            | 2100 kHz  | 43.3 kΩ          | 4 × 22 μF        | 2 × 4.7 μF + 2 × 100 nF           | 2.2 μH, 11.4 mΩ | LMR33620CRNX |
| 5 V              | 400 kHz   | 24.9 kΩ          | 4 × 22 μF        | 2 × 4.7 μF + 2 × 100 nF           | 6.8 μH, 14 mΩ   | LMR33620ARNX |
| 5 V              | 1400 KHz  | 24.9 kΩ          | 4 × 22 μF        | 2 × 4.7 μF + 2 × 100 nF           | 2.2 μH, 11.4 mΩ | LMR33620BRNX |
| 5 V              | 2100 kHz  | 24.9 kΩ          | 4 × 22 μF        | 2 × 4.7 μF + 2 × 100 nF           | 2.2 μH, 11.4 mΩ | LMR33620CRNX |

(1) The values in this table were selected to enhance certain performance criteria and may not represent typical values.

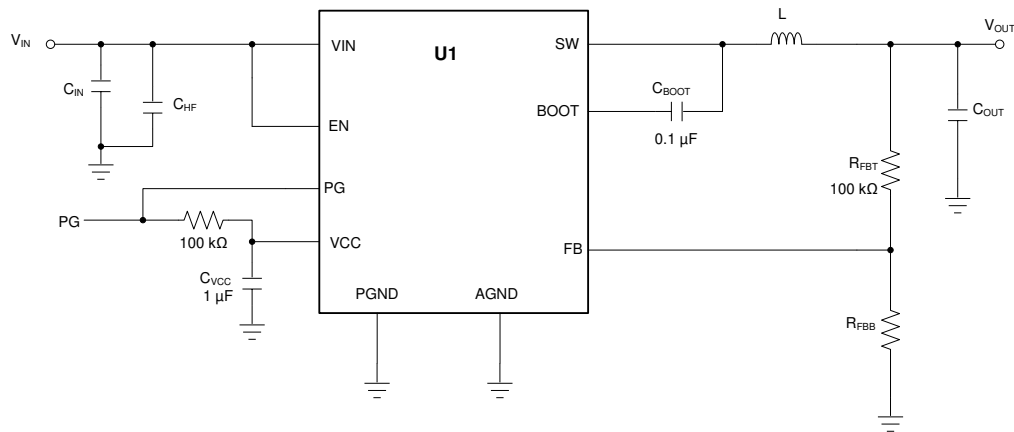
### 8.3 What to Do and What Not to Do

- **Don't:** Exceed the [Absolute Maximum Ratings](#).
- **Don't:** Exceed the [ESD Ratings](#).
- **Don't:** Exceed the [Recommended Operating Conditions](#).
- **Don't:** Allow the EN input to float.
- **Don't:** Allow the output voltage to exceed the input voltage, nor go below ground.
- **Don't:** Use the value of  $R_{\theta JA}$  given in the [Thermal Information](#) table to design your application. Use the information in the [Maximum Ambient Temperature](#) section.
- **Do:** Follow all the guidelines and suggestions found in this data sheet before committing the design to production. TI application engineers are ready to help critique your design and PCB layout to help make your project a success (see [节 11.3](#)).



## 9 Power Supply Recommendations

The characteristics of the input supply must be compatible with [§ 6.1](#) and [§ 6.3](#) found in this data sheet. In addition, the input supply must be capable of delivering the required input current to the loaded regulator. The average input current can be estimated with [方程式 12](#), where  $\eta$  is the efficiency.

$$I_{IN} = \frac{V_{OUT} \cdot I_{OUT}}{V_{IN} \cdot \eta} \quad (12)$$

If the regulator is connected to the input supply through long wires or PCB traces, special care is required to achieve good performance. The parasitic inductance and resistance of the input cables can have an adverse effect on the operation of the regulator. The parasitic inductance, in combination with the low-ESR, ceramic input capacitors, can form an under damped resonant circuit, resulting in overvoltage transients at the input to the regulator. The parasitic resistance can cause the voltage at the VIN pin to dip whenever a load transient is applied to the output. If the application is operating close to the minimum input voltage, this dip can cause the regulator to momentarily shutdown and reset. The best way to solve these kind of issues is to reduce the distance from the input supply to the regulator and/or use an aluminum or tantalum input capacitor in parallel with the ceramics. The moderate ESR of these types of capacitors help damp the input resonant circuit and reduce any overshoots. A value in the range of 20  $\mu$ F to 100  $\mu$ F is usually sufficient to provide input damping and help to hold the input voltage steady during large load transients.

Sometimes, for other system considerations, an input filter is used in front of the regulator. This can lead to instability, as well as some of the effects mentioned above, unless it is designed carefully. The user guide [AN-2162 Simple Success With Conducted EMI From DCDC Converters](#) provides helpful suggestions when designing an input filter for any switching regulator.

In some cases, a transient voltage suppressor (TVS) is used on the input of regulators. One class of this device has a *snap-back* characteristic (thyristor type). The use of a device with this type of characteristic is not recommended. When the TVS fires, the clamping voltage falls to a very low value. If this voltage is less than the output voltage of the regulator, the output capacitors discharge through the device back to the input. This uncontrolled current flow can damage the device.

The input voltage must not be allowed to fall below the output voltage. In this scenario, such as a shorted input test, the output capacitors discharges through the internal parasitic diode found between the VIN and SW pins of the device. During this condition, the current can become uncontrolled, possibly causing damage to the device. If this scenario is considered likely, then a Schottky diode between the input supply and the output should be used.

## 10 Layout

### 10.1 Layout Guidelines

The PCB layout of any DC/DC converter is critical to the optimal performance of the design. Bad PCB layout can disrupt the operation of an otherwise good schematic design. Even if the converter regulates correctly, bad PCB layout can mean the difference between a robust design and one that cannot be mass produced. Furthermore, the EMI performance of the regulator is dependent on the PCB layout, to a great extent. In a buck converter, the most critical PCB feature is the loop formed by the input capacitor or input capacitors, and power ground, as shown in [图 10-1](#). This loop carries large transient currents that can cause large transient voltages when reacting with the trace inductance. These unwanted transient voltages will disrupt the proper operation of the converter. Because of this, the traces in this loop must be wide and short, and the loop area as small as possible to reduce the parasitic inductance. [图 10-2](#) shows a recommended layout for the critical components of the LMR33620-Q1.

1. **Place the input capacitor or capacitors as close as possible to the VIN and GND terminals.** VIN and GND pins are adjacent, simplifying the input capacitor placement. With the VQFN package there are two VIN/PGND pairs on either side of the package. This provides for a symmetrical layout and helps minimize switching noise and EMI generation. A wide VIN plane must be used on a lower layer to connect both of the VIN pairs together to the input supply; see the layout example.
2. **Place bypass capacitor for VCC close to the VCC pin.** This capacitor must be placed close to the device and routed with short, wide traces to the VCC and GND pins.
3. **Use wide traces for the C<sub>BOOT</sub> capacitor.** Place C<sub>BOOT</sub> close to the device with short/wide traces to the BOOT and SW pins. It is important to route the SW connection under the device to the NC pin, and use this path to connect the BOOT capacitor to SW.
4. **Place the feedback divider as close as possible to the FB pin of the device.** Place R<sub>FBB</sub>, R<sub>FBT</sub>, and C<sub>FF</sub>, if used, physically close to the device. The connections to FB and GND must be short and close to those pins on the device. The connection to V<sub>OUT</sub> can be somewhat longer. However, this latter trace must not be routed near any noise source (such as the SW node) that can capacitively couple into the feedback path of the regulator.
5. **Use at least one ground plane in one of the middle layers.** This plane acts as a noise shield and also act as a heat dissipation path.
6. **Provide wide paths for VIN, VOUT, and GND.** Making these paths as wide and direct as possible reduces any voltage drops on the input or output paths of the converter and maximizes efficiency.
7. **Provide enough PCB area for proper heat sinking.** As stated in [节 8.2.2.11](#), enough copper area must be used to ensure a low R<sub>θJA</sub>, commensurate with the maximum load current and ambient temperature. Make the top and bottom PCB layers with two-ounce copper; and no less than one ounce. If the PCB design uses multiple copper layers (recommended), thermal vias can also be connected to the inner layer heat-spreading ground planes.
8. **Keep switch area small.** Keep the copper area connecting the SW pin to the inductor as short and wide as possible. At the same time the total area of this node should be minimized to help reduce radiated EMI.

See the following PCB layout resources for additional important guidelines:

- [Layout Guidelines for Switching Power Supplies](#)
- [Simple Switcher PCB Layout Guidelines](#)
- [Construction Your Power Supply- Layout Considerations](#)
- [Low Radiated EMI Layout Made Simple with LM4360x and LM4600x](#)



图 10-1. Current Loops with Fast Edges

### 10.1.1 Ground and Thermal Considerations

As mentioned above, TI recommends using one of the middle layers as a solid ground plane. A ground plane provides shielding for sensitive circuits and traces. It also provides a quiet reference potential for the control circuitry. The AGND and PGND pins must be connected to the ground planes using vias next to the bypass capacitors. PGND pins are connected directly to the source of the low side MOSFET switch, and also connected directly to the grounds of the input and output capacitors. The PGND net contains noise at the switching frequency and can bounce due to load variations. The PGND trace, as well as the VIN and SW traces, must be constrained to one side of the ground planes. The other side of the ground plane contains much less noise and must be used for sensitive routes.

Use as much copper as possible, for system ground plane, on the top and bottom layers for the best heat dissipation. Use a four-layer board with the copper thickness for the four layers, starting from the top as: 2 oz / 1 oz / 1 oz / 2 oz. A four-layer board with enough copper thickness, and proper layout, provides low current conduction impedance, proper shielding, and lower thermal resistance.

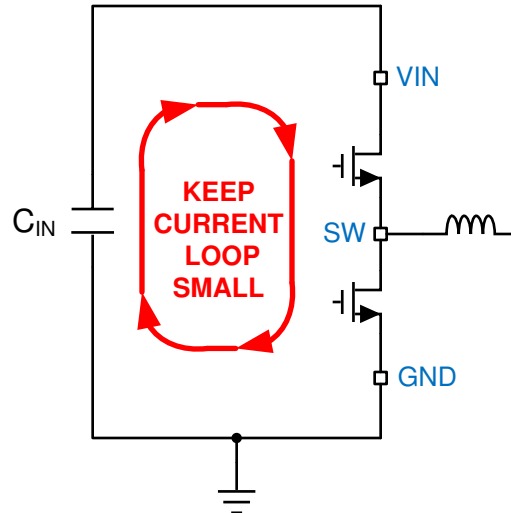
### 10.2 Layout Example

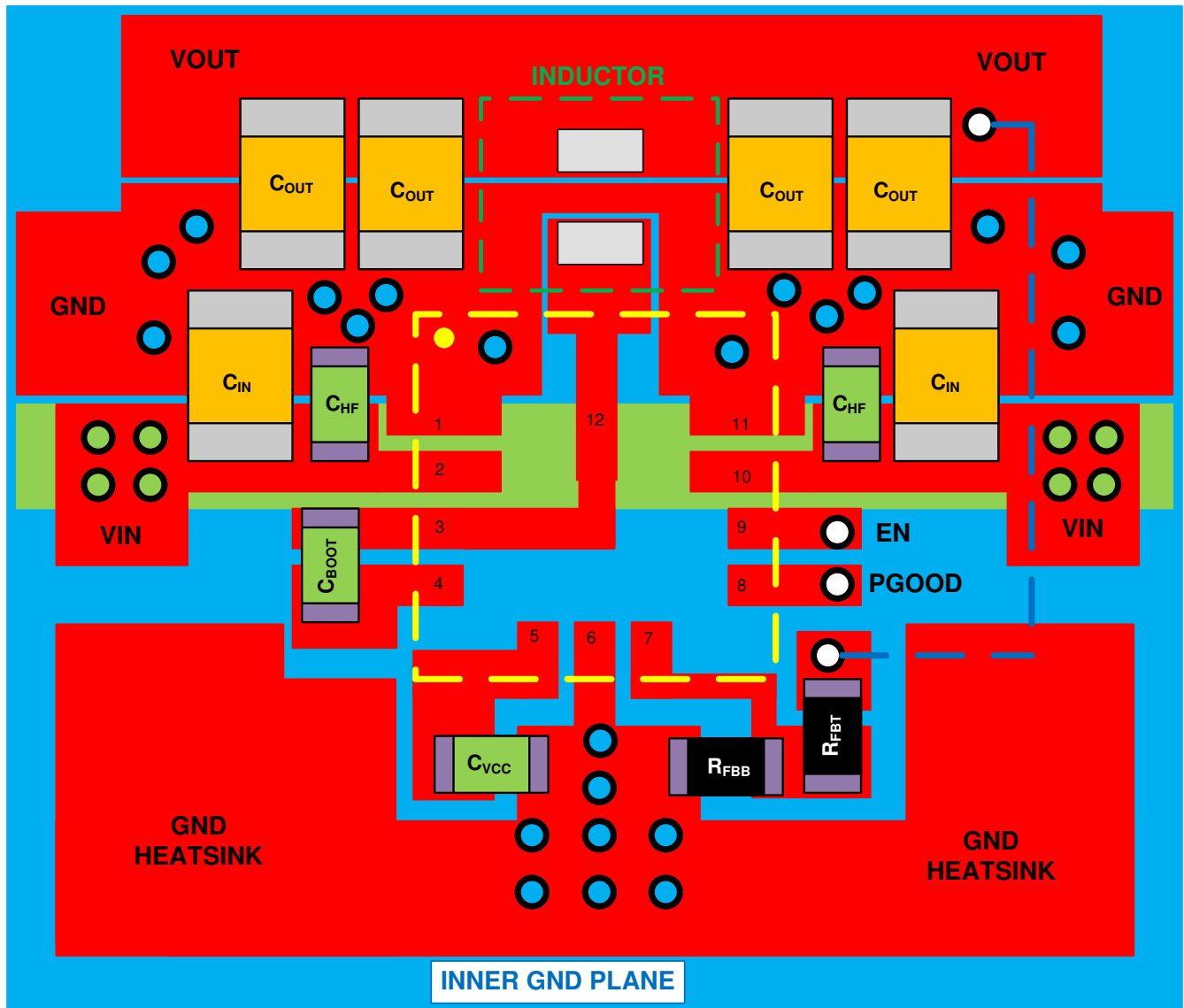

- Top Trace/Plane
- Inner GND Plane
- VIN Strap on Inner Layer
- VIA to Signal Layer
- VIA to GND Planes
- VIA to VIN Strap
- Trace on Signal Layer



图 10-2. Example Layout for VQFN Package

## 11 Device and Documentation Support

### 11.1 Device Support

#### 11.1.1 Development Support

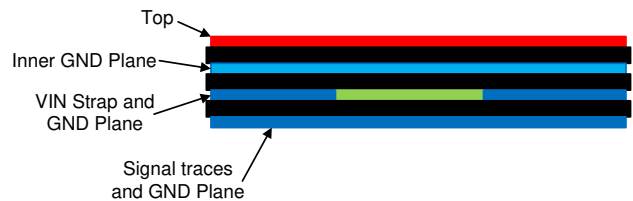
##### 11.1.1.1 Custom Design With WEBENCH® Tools

[Click here](#) to create a custom design using the LMR33620-Q1 device with the WEBENCH® Power Designer.

1. Start by entering the input voltage ( $V_{IN}$ ), output voltage ( $V_{OUT}$ ), and output current ( $I_{OUT}$ ) requirements.
2. Optimize the design for key parameters such as efficiency, footprint, and cost using the optimizer dial.
3. Compare the generated design with other possible solutions from Texas Instruments.

The WEBENCH Power Designer provides a customized schematic along with a list of materials with real-time pricing and component availability.

In most cases, these actions are available:

- Run electrical simulations to see important waveforms and circuit performance
- Run thermal simulations to understand board thermal performance
- Export customized schematic and layout into popular CAD formats
- Print PDF reports for the design, and share the design with colleagues

Get more information about WEBENCH tools at [www.ti.com/WEBENCH](http://www.ti.com/WEBENCH).

### 11.2 Documentation Support

#### 11.2.1 Related Documentation

For related documentation see the following:

- [Thermal Design by Insight not Hindsight](#)
- [A Guide to Board Layout for Best Thermal Resistance for Exposed Pad Packages](#)
- [Semiconductor and IC Package Thermal Metrics](#)
- [Thermal Design Made Simple with LM43603 and LM43602](#)
- [PowerPAD™ Thermally Enhanced Package](#)
- [PowerPAD™ Made Easy](#)
- [Using New Thermal Metrics](#)
- [Layout Guidelines for Switching Power Supplies](#)
- [Simple Switcher PCB Layout Guidelines](#)
- [Construction Your Power Supply- Layout Considerations](#)
- [Low Radiated EMI Layout Made Simple with LM4360x and LM4600x](#)

### 11.3 支持资源

TI E2E™ 支持论坛是工程师的重要参考资料，可直接从专家获得快速、经过验证的解答和设计帮助。搜索现有解答或提出自己的问题可获得所需的快速设计帮助。

链接的内容由各个贡献者“按原样”提供。这些内容并不构成 TI 技术规范，并且不一定反映 TI 的观点；请参阅 TI 的《使用条款》。

### 11.4 接收文档更新通知

要接收文档更新通知，请导航至 [ti.com](http://ti.com) 上的器件产品文件夹。点击 [订阅更新](#) 进行注册，即可每周接收产品信息更改摘要。有关更改的详细信息，请查看任何已修订文档中包含的修订历史记录。

### 11.5 Trademarks

TI E2E™ is a trademark of Texas Instruments.

WEBENCH® is a registered trademark of Texas Instruments.

所有商标均为其各自所有者的财产。

## 11.6 静电放电警告



静电放电 (ESD) 会损坏这个集成电路。德州仪器 (TI) 建议通过适当的预防措施处理所有集成电路。如果不遵守正确的处理和安装程序，可能会损坏集成电路。

ESD 的损坏小至导致微小的性能降级，大至整个器件故障。精密的集成电路可能更容易受到损坏，这是因为非常细微的参数更改都可能会导致器件与其发布的规格不相符。

## 11.7 术语表

### TI 术语表

本术语表列出并解释了术语、首字母缩略词和定义。

## **Mechanical, Packaging, and Orderable Information**

The following pages include mechanical, packaging, and orderable information. This information is the most current data available for the designated devices. This data is subject to change without notice and revision of this document. For browser-based versions of this data sheet, refer to the left-hand navigation.

**PACKAGING INFORMATION**

| Orderable Device  | Status<br>(1) | Package Type | Package Drawing | Pins | Package Qty | Eco Plan<br>(2) | Lead finish/<br>Ball material<br>(6) | MSL Peak Temp<br>(3) | Op Temp (°C) | Device Marking<br>(4/5) | Samples                 |
|-------------------|---------------|--------------|-----------------|------|-------------|-----------------|--------------------------------------|----------------------|--------------|-------------------------|-------------------------|
| LMR33620AQ5RNXRQ1 | ACTIVE        | VQFN-HR      | RNX             | 12   | 3000        | RoHS & Green    | NIPDAU   SN                          | Level-2-260C-1 YEAR  | -40 to 125   | 620AQ5                  | <a href="#">Samples</a> |
| LMR33620AQ5RNXTQ1 | ACTIVE        | VQFN-HR      | RNX             | 12   | 250         | RoHS & Green    | NIPDAU   SN                          | Level-2-260C-1 YEAR  | -40 to 125   | 620AQ5                  | <a href="#">Samples</a> |
| LMR33620AQRNXRQ1  | ACTIVE        | VQFN-HR      | RNX             | 12   | 3000        | RoHS & Green    | NIPDAU   SN                          | Level-2-260C-1 YEAR  | -40 to 125   | Z620AQ                  | <a href="#">Samples</a> |
| LMR33620AQRNXTQ1  | ACTIVE        | VQFN-HR      | RNX             | 12   | 250         | RoHS & Green    | NIPDAU   SN                          | Level-2-260C-1 YEAR  | -40 to 125   | Z620AQ                  | <a href="#">Samples</a> |
| LMR33620BQRNXRQ1  | ACTIVE        | VQFN-HR      | RNX             | 12   | 3000        | RoHS & Green    | NIPDAU   SN                          | Level-2-260C-1 YEAR  | -40 to 125   | Z620BQ                  | <a href="#">Samples</a> |
| LMR33620BQRNXTQ1  | ACTIVE        | VQFN-HR      | RNX             | 12   | 250         | RoHS & Green    | NIPDAU   SN                          | Level-2-260C-1 YEAR  | -40 to 125   | Z620BQ                  | <a href="#">Samples</a> |
| LMR33620CQ3RNXRQ1 | ACTIVE        | VQFN-HR      | RNX             | 12   | 3000        | RoHS & Green    | NIPDAU   SN                          | Level-2-260C-1 YEAR  | -40 to 125   | Z20CQ3                  | <a href="#">Samples</a> |
| LMR33620CQ3RNXTQ1 | ACTIVE        | VQFN-HR      | RNX             | 12   | 250         | RoHS & Green    | NIPDAU   SN                          | Level-2-260C-1 YEAR  | -40 to 125   | Z20CQ3                  | <a href="#">Samples</a> |
| LMR33620CQ5RNXRQ1 | ACTIVE        | VQFN-HR      | RNX             | 12   | 3000        | RoHS & Green    | NIPDAU   SN                          | Level-2-260C-1 YEAR  | -40 to 125   | Z205CQ                  | <a href="#">Samples</a> |
| LMR33620CQ5RNXTQ1 | ACTIVE        | VQFN-HR      | RNX             | 12   | 250         | RoHS & Green    | NIPDAU   SN                          | Level-2-260C-1 YEAR  | -40 to 125   | Z205CQ                  | <a href="#">Samples</a> |
| LMR33620CQRNXRQ1  | ACTIVE        | VQFN-HR      | RNX             | 12   | 3000        | RoHS & Green    | NIPDAU   SN                          | Level-2-260C-1 YEAR  | -40 to 125   | Z620CQ                  | <a href="#">Samples</a> |
| LMR33620CQRNXTQ1  | ACTIVE        | VQFN-HR      | RNX             | 12   | 250         | RoHS & Green    | NIPDAU   SN                          | Level-2-260C-1 YEAR  | -40 to 125   | Z620CQ                  | <a href="#">Samples</a> |

(1) The marketing status values are defined as follows:

**ACTIVE:** Product device recommended for new designs.

**LIFEBUY:** TI has announced that the device will be discontinued, and a lifetime-buy period is in effect.

**NRND:** Not recommended for new designs. Device is in production to support existing customers, but TI does not recommend using this part in a new design.

**PREVIEW:** Device has been announced but is not in production. Samples may or may not be available.

**OBSELETE:** TI has discontinued the production of the device.

(2) **RoHS:** TI defines "RoHS" to mean semiconductor products that are compliant with the current EU RoHS requirements for all 10 RoHS substances, including the requirement that RoHS substance do not exceed 0.1% by weight in homogeneous materials. Where designed to be soldered at high temperatures, "RoHS" products are suitable for use in specified lead-free processes. TI may reference these types of products as "Pb-Free".

**RoHS Exempt:** TI defines "RoHS Exempt" to mean products that contain lead but are compliant with EU RoHS pursuant to a specific EU RoHS exemption.

**Green:** TI defines "Green" to mean the content of Chlorine (Cl) and Bromine (Br) based flame retardants meet JS709B low halogen requirements of <=1000ppm threshold. Antimony trioxide based flame retardants must also meet the <=1000ppm threshold requirement.



- (3) MSL, Peak Temp. - The Moisture Sensitivity Level rating according to the JEDEC industry standard classifications, and peak solder temperature.
- (4) There may be additional marking, which relates to the logo, the lot trace code information, or the environmental category on the device.
- (5) Multiple Device Markings will be inside parentheses. Only one Device Marking contained in parentheses and separated by a "~" will appear on a device. If a line is indented then it is a continuation of the previous line and the two combined represent the entire Device Marking for that device.
- (6) Lead finish/Ball material - Orderable Devices may have multiple material finish options. Finish options are separated by a vertical ruled line. Lead finish/Ball material values may wrap to two lines if the finish value exceeds the maximum column width.

**Important Information and Disclaimer:**The information provided on this page represents TI's knowledge and belief as of the date that it is provided. TI bases its knowledge and belief on information provided by third parties, and makes no representation or warranty as to the accuracy of such information. Efforts are underway to better integrate information from third parties. TI has taken and continues to take reasonable steps to provide representative and accurate information but may not have conducted destructive testing or chemical analysis on incoming materials and chemicals. TI and TI suppliers consider certain information to be proprietary, and thus CAS numbers and other limited information may not be available for release.

In no event shall TI's liability arising out of such information exceed the total purchase price of the TI part(s) at issue in this document sold by TI to Customer on an annual basis.

**OTHER QUALIFIED VERSIONS OF LMR33620-Q1 :**

- Catalog : [LMR33620](#)

NOTE: Qualified Version Definitions:

- Catalog - TI's standard catalog product

**TAPE AND REEL INFORMATION**

**QUADRANT ASSIGNMENTS FOR PIN 1 ORIENTATION IN TAPE**

\*All dimensions are nominal

| Device            | Package Type | Package Drawing | Pins | SPQ  | Reel Diameter (mm) | Reel Width W1 (mm) | A0 (mm) | B0 (mm) | K0 (mm) | P1 (mm) | W (mm) | Pin1 Quadrant |
|-------------------|--------------|-----------------|------|------|--------------------|--------------------|---------|---------|---------|---------|--------|---------------|
| LMR33620AQ5RNXRQ1 | VQFN-HR      | RNX             | 12   | 3000 | 180.0              | 8.4                | 2.3     | 3.2     | 1.0     | 4.0     | 8.0    | Q1            |
| LMR33620AQ5RNXRQ1 | VQFN-HR      | RNX             | 12   | 3000 | 180.0              | 8.4                | 2.25    | 3.25    | 1.05    | 4.0     | 8.0    | Q1            |
| LMR33620AQ5RNXTQ1 | VQFN-HR      | RNX             | 12   | 250  | 180.0              | 8.4                | 2.25    | 3.25    | 1.05    | 4.0     | 8.0    | Q1            |
| LMR33620AQ5RNXTQ1 | VQFN-HR      | RNX             | 12   | 250  | 180.0              | 8.4                | 2.3     | 3.2     | 1.0     | 4.0     | 8.0    | Q1            |
| LMR33620AQRNXRQ1  | VQFN-HR      | RNX             | 12   | 3000 | 180.0              | 8.4                | 2.25    | 3.25    | 1.05    | 4.0     | 8.0    | Q1            |
| LMR33620AQRNXTQ1  | VQFN-HR      | RNX             | 12   | 250  | 180.0              | 8.4                | 2.3     | 3.2     | 1.0     | 4.0     | 8.0    | Q1            |
| LMR33620AQRNXTQ1  | VQFN-HR      | RNX             | 12   | 250  | 180.0              | 8.4                | 2.25    | 3.25    | 1.05    | 4.0     | 8.0    | Q1            |
| LMR33620BQRNXRQ1  | VQFN-HR      | RNX             | 12   | 3000 | 180.0              | 8.4                | 2.25    | 3.25    | 1.05    | 4.0     | 8.0    | Q1            |
| LMR33620BQRNXRQ1  | VQFN-HR      | RNX             | 12   | 3000 | 180.0              | 8.4                | 2.3     | 3.2     | 1.0     | 4.0     | 8.0    | Q1            |

| Device            | Package Type | Package Drawing | Pins | SPQ  | Reel Diameter (mm) | Reel Width W1 (mm) | A0 (mm) | B0 (mm) | K0 (mm) | P1 (mm) | W (mm) | Pin1 Quadrant |
|-------------------|--------------|-----------------|------|------|--------------------|--------------------|---------|---------|---------|---------|--------|---------------|
| LMR33620BQRNXTQ1  | VQFN-HR      | RNX             | 12   | 250  | 180.0              | 8.4                | 2.3     | 3.2     | 1.0     | 4.0     | 8.0    | Q1            |
| LMR33620BQRNXTQ1  | VQFN-HR      | RNX             | 12   | 250  | 180.0              | 8.4                | 2.25    | 3.25    | 1.05    | 4.0     | 8.0    | Q1            |
| LMR33620CQ3RNXRQ1 | VQFN-HR      | RNX             | 12   | 3000 | 180.0              | 8.4                | 2.3     | 3.2     | 1.0     | 4.0     | 8.0    | Q1            |
| LMR33620CQ3RNXRQ1 | VQFN-HR      | RNX             | 12   | 3000 | 180.0              | 8.4                | 2.25    | 3.25    | 1.05    | 4.0     | 8.0    | Q1            |
| LMR33620CQ3RNXTQ1 | VQFN-HR      | RNX             | 12   | 250  | 180.0              | 8.4                | 2.25    | 3.25    | 1.05    | 4.0     | 8.0    | Q1            |
| LMR33620CQ3RNXTQ1 | VQFN-HR      | RNX             | 12   | 250  | 180.0              | 8.4                | 2.3     | 3.2     | 1.0     | 4.0     | 8.0    | Q1            |
| LMR33620CQ5RNXRQ1 | VQFN-HR      | RNX             | 12   | 3000 | 180.0              | 8.4                | 2.25    | 3.25    | 1.05    | 4.0     | 8.0    | Q1            |
| LMR33620CQ5RNXTQ1 | VQFN-HR      | RNX             | 12   | 250  | 180.0              | 8.4                | 2.3     | 3.2     | 1.0     | 4.0     | 8.0    | Q1            |
| LMR33620CQ5RNXTQ1 | VQFN-HR      | RNX             | 12   | 250  | 180.0              | 8.4                | 2.25    | 3.25    | 1.05    | 4.0     | 8.0    | Q1            |
| LMR33620CQRNXRQ1  | VQFN-HR      | RNX             | 12   | 3000 | 180.0              | 8.4                | 2.25    | 3.25    | 1.05    | 4.0     | 8.0    | Q1            |
| LMR33620CQRNXTQ1  | VQFN-HR      | RNX             | 12   | 250  | 180.0              | 8.4                | 2.3     | 3.2     | 1.0     | 4.0     | 8.0    | Q1            |
| LMR33620CQRNXTQ1  | VQFN-HR      | RNX             | 12   | 250  | 180.0              | 8.4                | 2.25    | 3.25    | 1.05    | 4.0     | 8.0    | Q1            |

## TAPE AND REEL BOX DIMENSIONS



\*All dimensions are nominal

| Device            | Package Type | Package Drawing | Pins | SPQ  | Length (mm) | Width (mm) | Height (mm) |
|-------------------|--------------|-----------------|------|------|-------------|------------|-------------|
| LMR33620AQ5RNXRQ1 | VQFN-HR      | RNX             | 12   | 3000 | 213.0       | 191.0      | 35.0        |
| LMR33620AQ5RNXRQ1 | VQFN-HR      | RNX             | 12   | 3000 | 210.0       | 185.0      | 35.0        |
| LMR33620AQ5RNXTQ1 | VQFN-HR      | RNX             | 12   | 250  | 210.0       | 185.0      | 35.0        |
| LMR33620AQ5RNXTQ1 | VQFN-HR      | RNX             | 12   | 250  | 213.0       | 191.0      | 35.0        |
| LMR33620AQRNXRQ1  | VQFN-HR      | RNX             | 12   | 3000 | 210.0       | 185.0      | 35.0        |
| LMR33620AQRNXTQ1  | VQFN-HR      | RNX             | 12   | 250  | 213.0       | 191.0      | 35.0        |
| LMR33620AQRNXTQ1  | VQFN-HR      | RNX             | 12   | 250  | 210.0       | 185.0      | 35.0        |
| LMR33620BQRNXRQ1  | VQFN-HR      | RNX             | 12   | 3000 | 210.0       | 185.0      | 35.0        |
| LMR33620BQRNXRQ1  | VQFN-HR      | RNX             | 12   | 3000 | 213.0       | 191.0      | 35.0        |
| LMR33620BQRNXTQ1  | VQFN-HR      | RNX             | 12   | 250  | 213.0       | 191.0      | 35.0        |
| LMR33620BQRNXTQ1  | VQFN-HR      | RNX             | 12   | 250  | 210.0       | 185.0      | 35.0        |
| LMR33620CQ3RNXRQ1 | VQFN-HR      | RNX             | 12   | 3000 | 213.0       | 191.0      | 35.0        |
| LMR33620CQ3RNXRQ1 | VQFN-HR      | RNX             | 12   | 3000 | 210.0       | 185.0      | 35.0        |
| LMR33620CQ3RNXTQ1 | VQFN-HR      | RNX             | 12   | 250  | 210.0       | 185.0      | 35.0        |
| LMR33620CQ3RNXTQ1 | VQFN-HR      | RNX             | 12   | 250  | 213.0       | 191.0      | 35.0        |
| LMR33620CQ5RNXRQ1 | VQFN-HR      | RNX             | 12   | 3000 | 210.0       | 185.0      | 35.0        |
| LMR33620CQ5RNXTQ1 | VQFN-HR      | RNX             | 12   | 250  | 213.0       | 191.0      | 35.0        |
| LMR33620CQ5RNXTQ1 | VQFN-HR      | RNX             | 12   | 250  | 210.0       | 185.0      | 35.0        |

---

| Device           | Package Type | Package Drawing | Pins | SPQ  | Length (mm) | Width (mm) | Height (mm) |
|------------------|--------------|-----------------|------|------|-------------|------------|-------------|
| LMR33620CQRNXRQ1 | VQFN-HR      | RNX             | 12   | 3000 | 210.0       | 185.0      | 35.0        |
| LMR33620CQRNXTQ1 | VQFN-HR      | RNX             | 12   | 250  | 213.0       | 191.0      | 35.0        |
| LMR33620CQRNXTQ1 | VQFN-HR      | RNX             | 12   | 250  | 210.0       | 185.0      | 35.0        |

## GENERIC PACKAGE VIEW

**RNX 12**

**VQFN-HR - 1 mm max height**

**2 x 3 mm, 0.5 mm pitch**

PLASTIC QUAD FLATPACK-NO LEAD

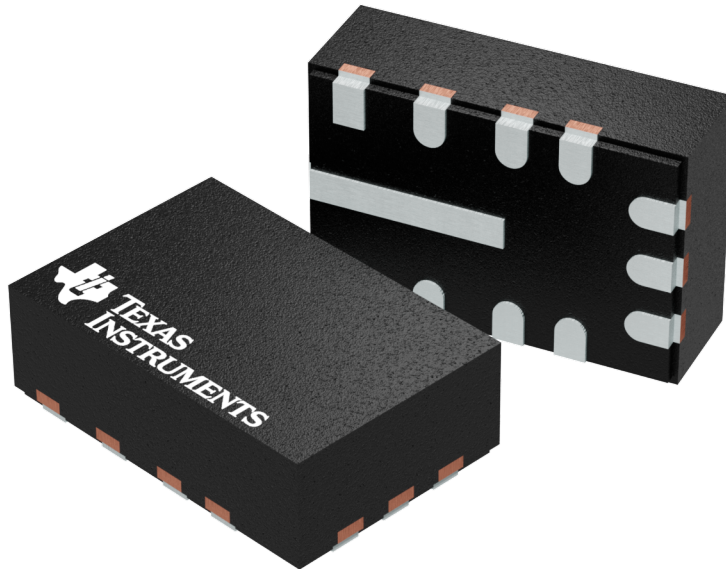

Images above are just a representation of the package family, actual package may vary.  
Refer to the product data sheet for package details.

4224286/A

# RNX0012B



# PACKAGE OUTLINE

## VQFN-HR - 0.9 mm max height

PLASTIC QUAD FLATPACK - NO LEAD

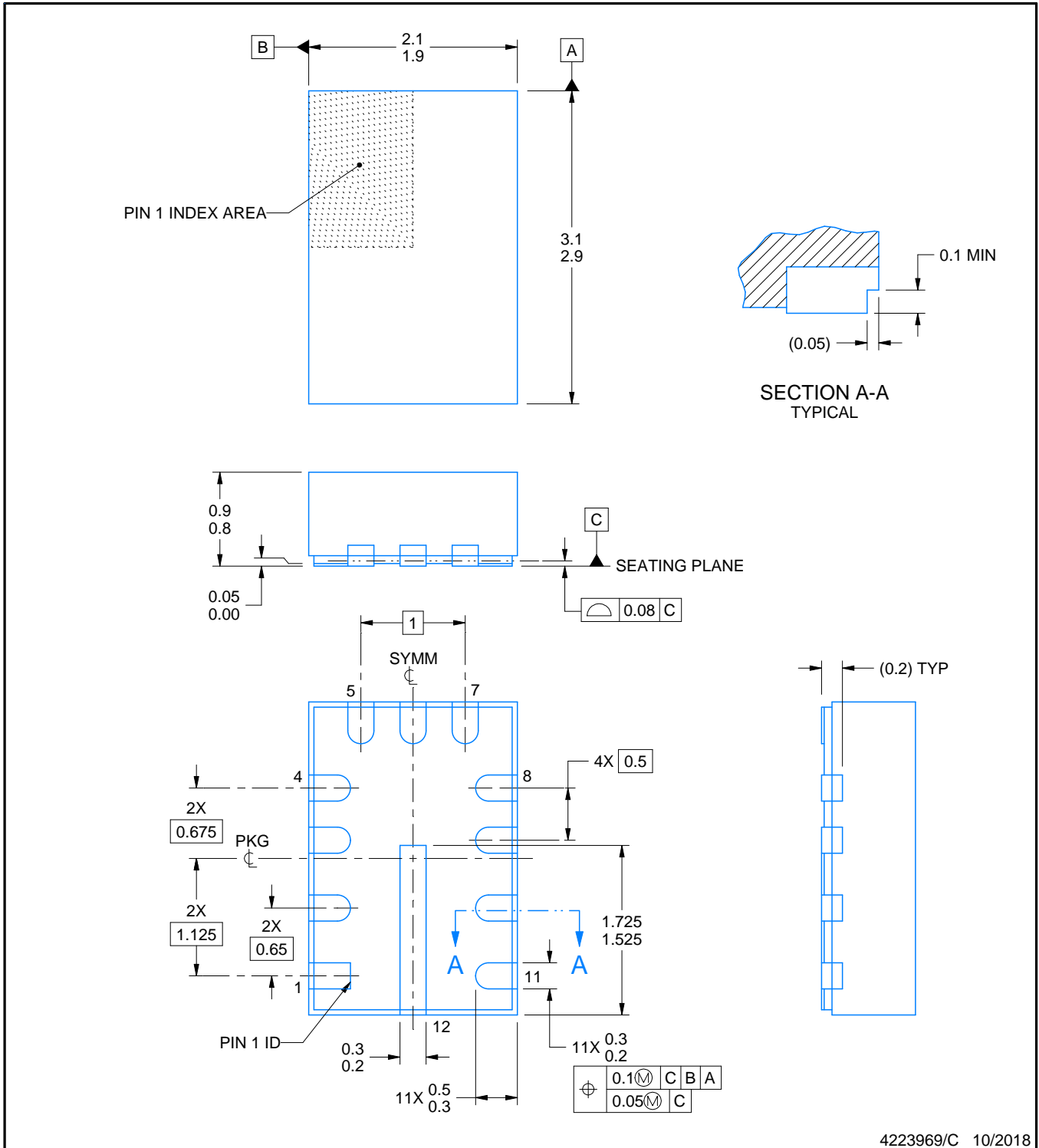

4223969/C 10/2018

### NOTES:

1. All linear dimensions are in millimeters. Any dimensions in parenthesis are for reference only. Dimensioning and tolerancing per ASME Y14.5M.
2. This drawing is subject to change without notice.
3. The package thermal pad must be soldered to the printed circuit board for thermal and mechanical performance.

# EXAMPLE BOARD LAYOUT

RNX0012B

VQFN-HR - 0.9 mm max height

PLASTIC QUAD FLATPACK - NO LEAD

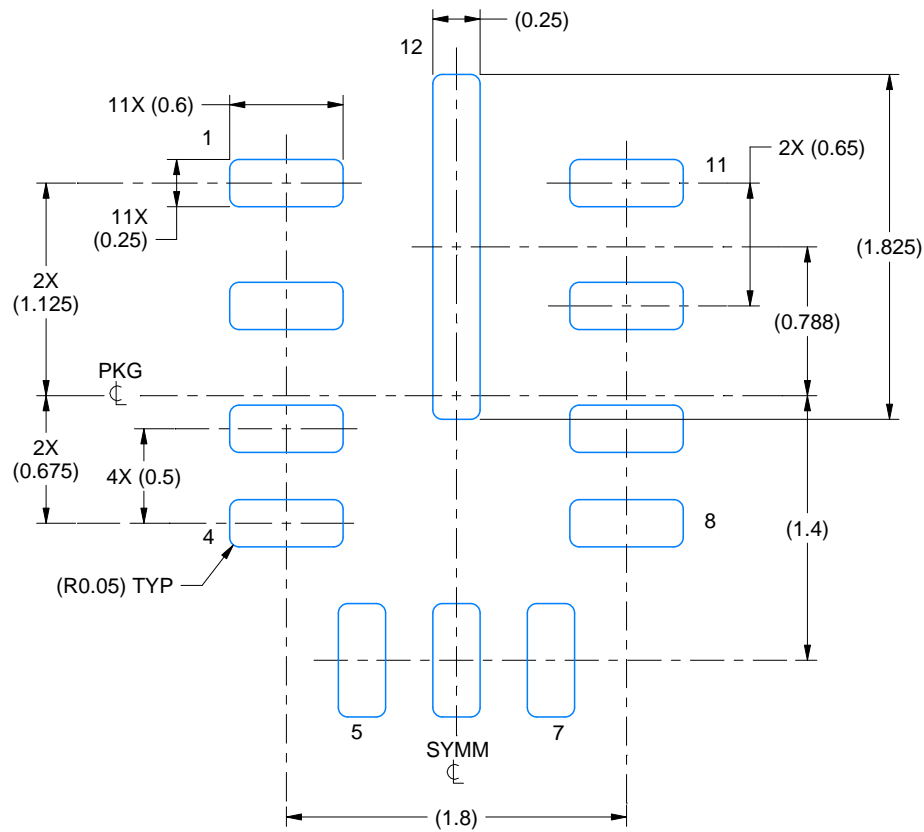

LAND PATTERN EXAMPLE  
EXPOSED METAL SHOWN  
SCALE:25X

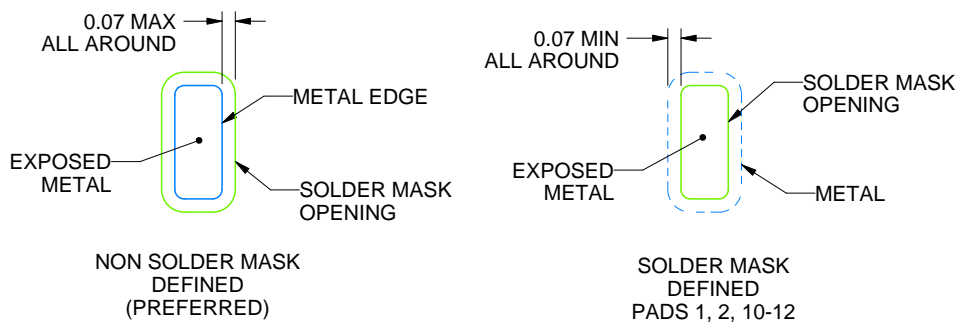

SOLDER MASK DETAILS

4223969/C 10/2018

NOTES: (continued)

4. This package is designed to be soldered to a thermal pad on the board. For more information, see Texas Instruments literature number SLUA271 ([www.ti.com/lit/slua271](http://www.ti.com/lit/slua271)).



# EXAMPLE STENCIL DESIGN

RNX0012B

VQFN-HR - 0.9 mm max height

PLASTIC QUAD FLATPACK - NO LEAD

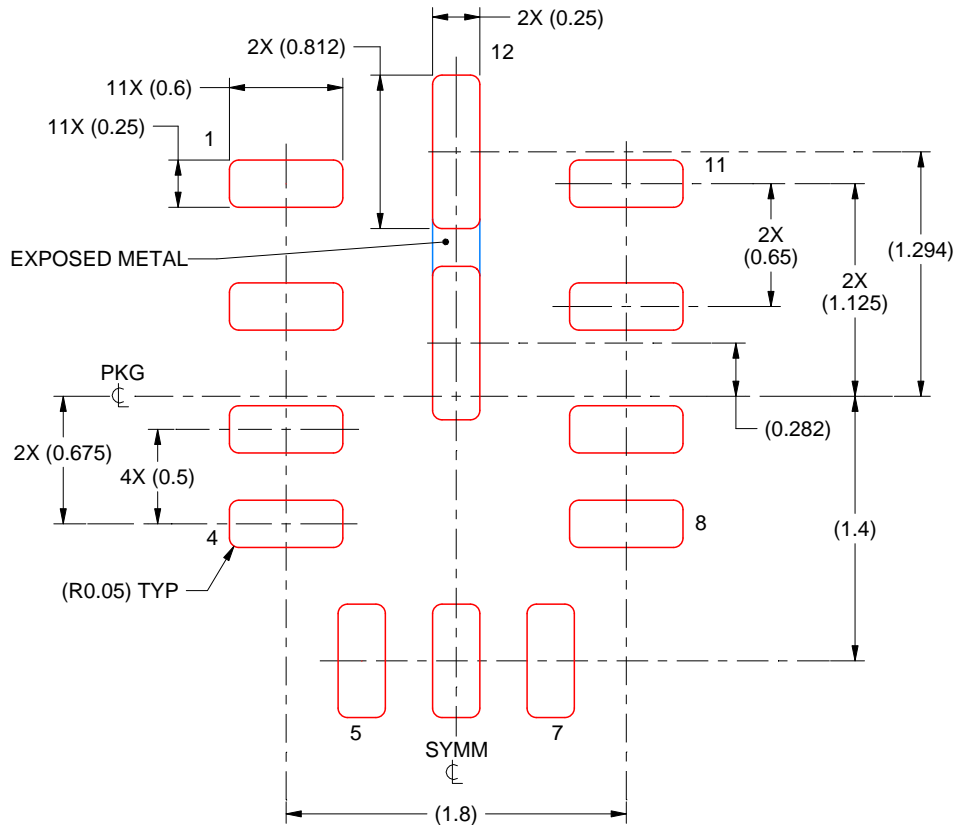

SOLDER PASTE EXAMPLE  
BASED ON 0.125 mm THICK STENCIL

FOR PAD 12  
87.7% PRINTED SOLDER COVERAGE BY AREA  
SCALE:25X

4223969/C 10/2018

NOTES: (continued)

5. Laser cutting apertures with trapezoidal walls and rounded corners may offer better paste release. IPC-7525 may have alternate design recommendations.

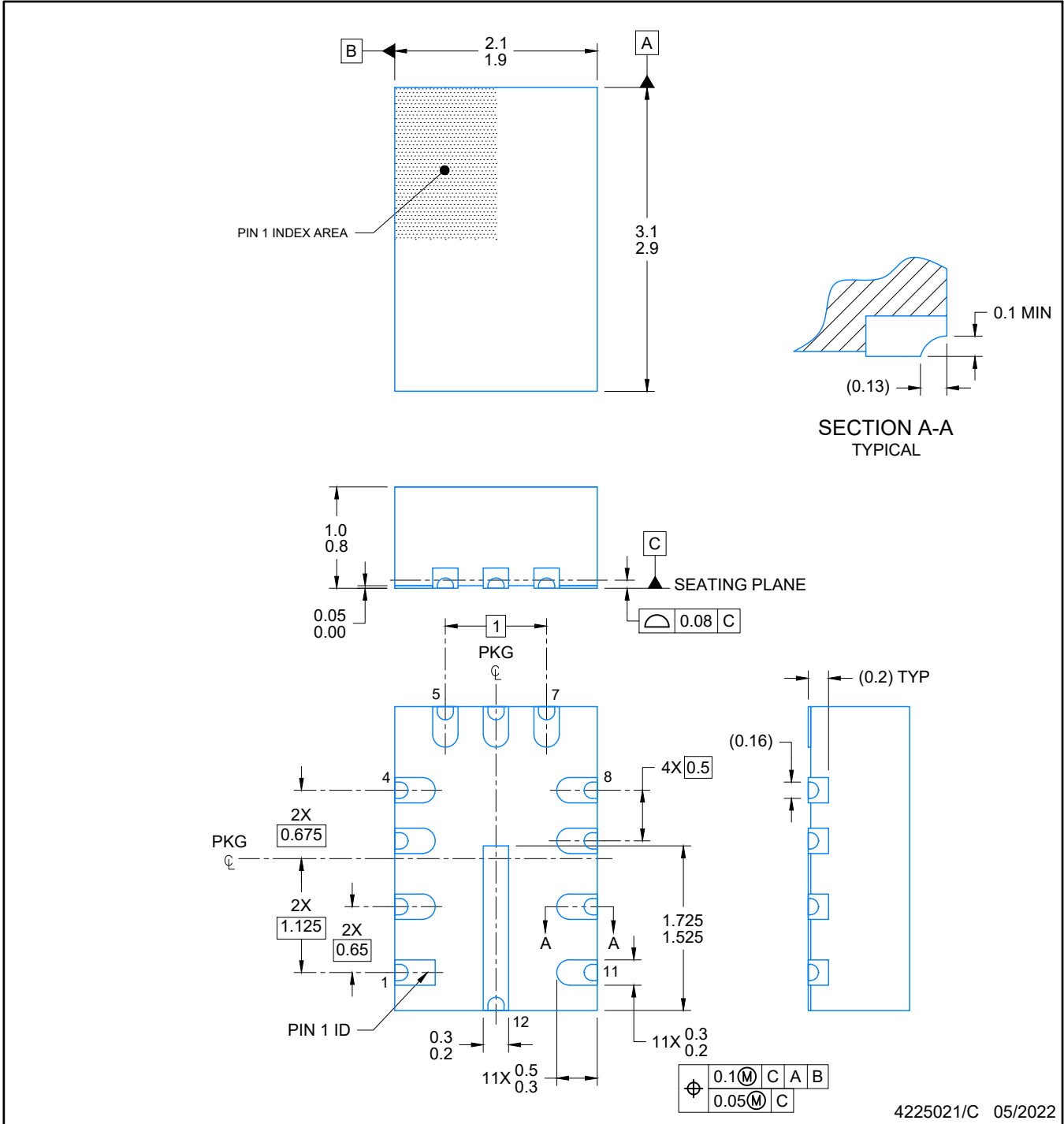

**NOTES:**

1. All linear dimensions are in millimeters. Any dimensions in parenthesis are for reference only. Dimensioning and tolerancing per ASME Y14.5M.
2. This drawing is subject to change without notice.

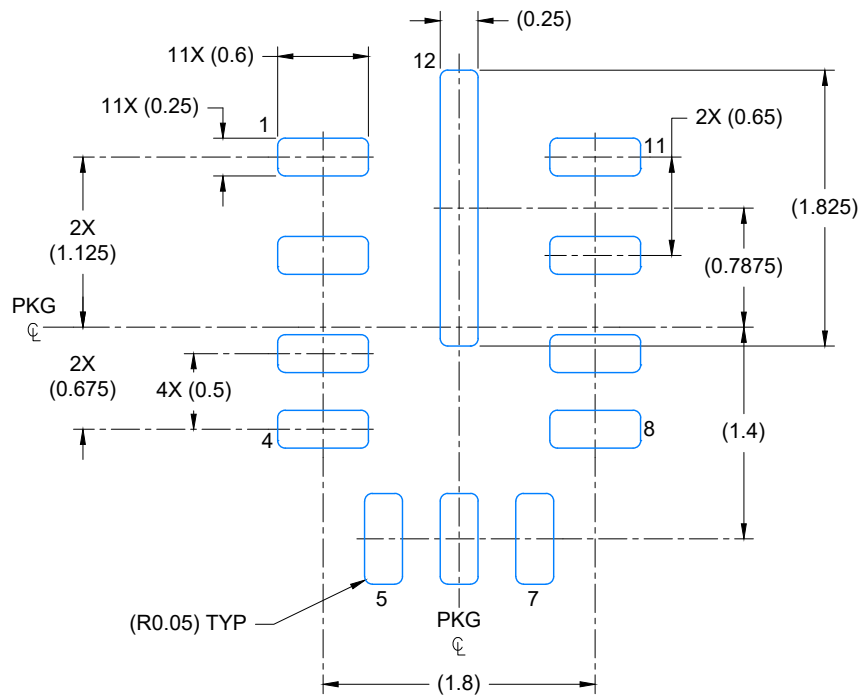

LAND PATTERN EXAMPLE  
SCALE: 20X

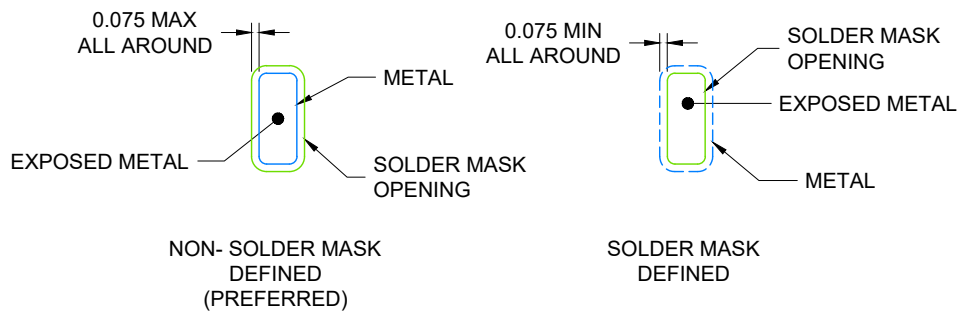

SOLDER MASK DETAILS

4225021/C 05/2022

NOTES: (continued)

3. For more information, see Texas Instruments literature number SLUA271 ([www.ti.com/lit/sluea271](http://www.ti.com/lit/sluea271)).
4. Solder mask tolerances between and around signal pads can vary based on board fabrication site.

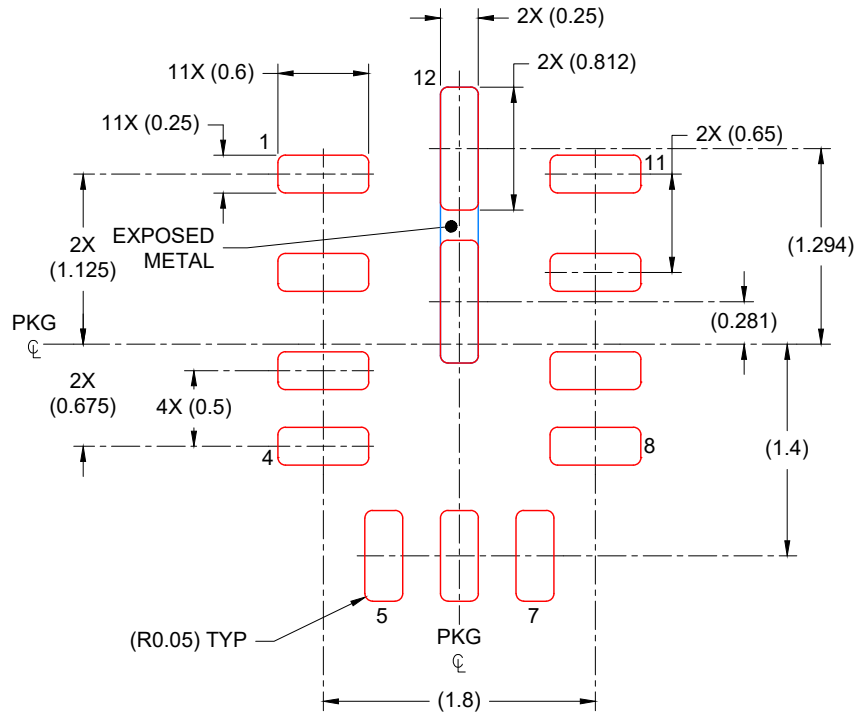

SOLDER PASTE EXAMPLE  
 BASED ON 0.100 mm THICK STENCIL

FOR PAD 12  
 87.7% PRINTED COVERAGE BY AREA  
 SCALE: 20X

4225021/C 05/2022

NOTES: (continued)

5. Laser cutting apertures with trapezoidal walls and rounded corners may offer better paste release. IPC-7525 may have alternate design recommendations.

## 重要声明和免责声明

TI“按原样”提供技术和可靠性数据（包括数据表）、设计资源（包括参考设计）、应用或其他设计建议、网络工具、安全信息和其他资源，不保证没有瑕疵且不做任何明示或暗示的担保，包括但不限于对适销性、某特定用途方面的适用性或不侵犯任何第三方知识产权的暗示担保。

这些资源可供使用 TI 产品进行设计的熟练开发人员使用。您将自行承担以下全部责任：(1) 针对您的应用选择合适的 TI 产品，(2) 设计、验证并测试您的应用，(3) 确保您的应用满足相应标准以及任何其他功能安全、信息安全、监管或其他要求。

这些资源如有变更，恕不另行通知。TI 授权您仅可将这些资源用于研发本资源所述的 TI 产品的应用。严禁对这些资源进行其他复制或展示。您无权使用任何其他 TI 知识产权或任何第三方知识产权。您应全额赔偿因在这些资源的使用中对 TI 及其代表造成的任何索赔、损害、成本、损失和债务，TI 对此概不负责。

TI 提供的产品受 [TI 的销售条款](#) 或 [ti.com](#) 上其他适用条款/TI 产品随附的其他适用条款的约束。TI 提供这些资源并不会扩展或以其他方式更改 TI 针对 TI 产品发布的适用的担保或担保免责声明。

TI 反对并拒绝您可能提出的任何其他或不同的条款。

邮寄地址：Texas Instruments, Post Office Box 655303, Dallas, Texas 75265

Copyright © 2022，德州仪器 (TI) 公司