

NCV4264-2C

Low I_Q Low Dropout Linear Regulator

The NCV4264-2C is a low quiescent current consumption LDO regulator. Its output stage supplies 100 mA with $\pm 2.0\%$ output voltage accuracy.

Maximum dropout voltage is 500 mV at 100 mA load current.

It is internally protected against 45 V input transients, input supply reversal, output overcurrent faults, and excess die temperature. No external components are required to enable these features.

Features

- 3.3 V and 5.0 V Fixed Output
- $\pm 2.0\%$ Output Accuracy, Over Full Temperature Range
- 33 μ A Typical Quiescent Current
- 500 mV Maximum Dropout Voltage at 100 mA Load Current
- Wide Input Voltage Operating Range of 4.5 V to 45 V
- Internal Fault Protection
 - ◆ -42 V Reverse Voltage
 - ◆ Short Circuit/Overcurrent
 - ◆ Thermal Overload
- NCV Prefix for Automotive and Other Applications Requiring Unique Site and Control Change Requirements; AEC-Q100 Qualified and PPAP Capable
- This is a Pb-Free Device



ON Semiconductor®

<http://onsemi.com>

MARKING DIAGRAM



SOT-223
ST SUFFIX
CASE 318E

x = 5 (5.0 V Version)
3 (3.3 V Version)
A = Assembly Location
Y = Year
W = Work Week
▪ = Pb-Free Package

(*Note: Microdot may be in either location)

PIN CONNECTIONS

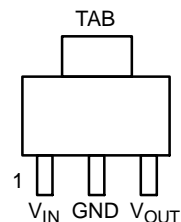

(Top View)

ORDERING INFORMATION

See detailed ordering and shipping information in the package dimensions section on page 9 of this data sheet.

NCV4264-2C

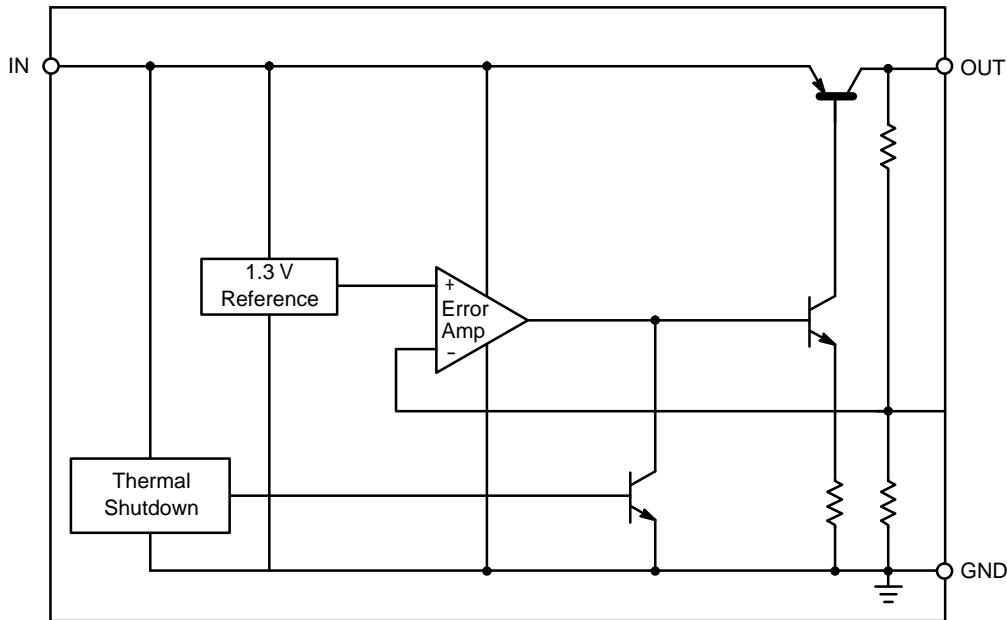

Figure 1. Block Diagram

PIN FUNCTION DESCRIPTION

Pin No.	Symbol	Function
1	V_{IN}	Unregulated input voltage; 4.5 V to 45 V.
2	GND	Ground; substrate.
3	V_{OUT}	Regulated output voltage; collector of the internal PNP pass transistor.
TAB	GND	Ground; substrate and best thermal connection to the die.

OPERATING RANGE

Rating	Symbol	Min	Max	Unit
V_{IN} , DC Input Operating Voltage (Note 3)	V_{IN}	4.5	+45	V
Junction Temperature Operating Range	T_J	-40	+150	°C

Functional operation above the stresses listed in the Recommended Operating Ranges is not implied. Extended exposure to stresses beyond the Recommended Operating Ranges limits may affect device reliability.

MAXIMUM RATINGS

Rating	Symbol	Min	Max	Unit
V_{IN} , DC Input Voltage	V_{IN}	-42	+45	V
V_{OUT} , DC Voltage	V_{OUT}	-0.3	+32	V
Storage Temperature	T_{stg}	-55	+150	°C
Moisture Sensitivity Level	MSL	3		-
ESD Capability, Human Body Model (Note 1)	V_{ESDHB}	4000	-	V
ESD Capability, Machine Model (Note 1)	V_{ESDMIM}	200	-	V
Lead Temperature Soldering Reflow (SMD Styles Only), Lead Free (Note 2)	T_{slid}	-	265 pk	°C

Stresses exceeding those listed in the Maximum Ratings table may damage the device. If any of these limits are exceeded, device functionality should not be assumed, damage may occur and reliability may be affected.

- This device series incorporates ESD protection and is tested by the following methods:
ESD HBM tested per AEC-Q100-002 (EIA/JESD22-A 114C)
ESD MM tested per AEC-Q100-003 (EIA/JESD22-A 115C)
- Lead Free, 60 sec – 150 sec above 217°C, 40 sec max at peak.
- See specific conditions for DC operating input voltage lower than 4.5 V in ELECTRICAL CHARACTERISTICS table at page 3

NCV4264-2C

THERMAL RESISTANCE

Parameter	Symbol	Min	Max	Unit
Junction-to-Ambient	SOT-223 $R_{\theta JA}$	-	109 (Note 4)	°C/W
Junction-to-Tab (psi-JL4)	SOT-223 Ψ_{JL4}	-	10.9	

ELECTRICAL CHARACTERISTICS ($V_{IN} = 13.5\text{ V}$, $T_J = -40^\circ\text{C}$ to $+150^\circ\text{C}$, unless otherwise noted.)

Characteristic	Symbol	Test Conditions	Min	Typ	Max	Unit
Output Voltage 5.0 V Version	V_{OUT}	$5.0\text{ mA} \leq I_{OUT} \leq 100\text{ mA}$ (Note 5) $6.0\text{ V} \leq V_{IN} \leq 28\text{ V}$	4.900	5.000	5.100	V
Output Voltage 3.3 V Version	V_{OUT}	$5.0\text{ mA} \leq I_{OUT} \leq 100\text{ mA}$ (Note 5) $4.5\text{ V} \leq V_{IN} \leq 28\text{ V}$	3.234	3.300	3.366	V
Output Voltage 3.3 V Version	V_{OUT}	$I_{OUT} = 5\text{ mA}$, $V_{IN} = 4\text{ V}$ (Note 7)	3.234	3.300	3.366	V
Line Regulation 5.0 V Version	ΔV_{OUT} vs. V_{IN}	$I_{OUT} = 5.0\text{ mA}$ $6.0\text{ V} \leq V_{IN} \leq 28\text{ V}$	-30	5.0	+30	mV
Line Regulation 3.3 V Version	ΔV_{OUT} vs. V_{IN}	$I_{OUT} = 5.0\text{ mA}$ $4.5\text{ V} \leq V_{IN} \leq 28\text{ V}$	-30	5.0	+30	mV
Load Regulation	ΔV_{OUT} vs. I_{OUT}	$1.0\text{ mA} \leq I_{OUT} \leq 100\text{ mA}$ (Note 5)	-40	5.0	+40	mV
Dropout Voltage – 5.0 V Version	$V_{IN} - V_{OUT}$	$I_{OUT} = 100\text{ mA}$ (Notes 5 & 6)	-	270	500	mV
Quiescent Current	I_q	$I_{OUT} = 100\text{ }\mu\text{A}$ $T_J = 25^\circ\text{C}$ $T_J = -40^\circ\text{C}$ to $+85^\circ\text{C}$ $T_J = -40^\circ\text{C}$ to 150°C	-	33	55	μA
Active Ground Current	$I_{G(ON)}$	$I_{OUT} = 50\text{ mA}$ (Note 5)	-	1.5	4.0	mA
Power Supply Rejection	PSRR	$V_{RIPPLE} = 0.5\text{ V}_{P-P}$, $F = 100\text{ Hz}$	-	67	-	dB

PROTECTION

Current Limit	$I_{OUT(LIM)}$	$V_{OUT} = 4.5\text{ V}$ (5.0 V Version) (Note 5) $V_{OUT} = 3.0\text{ V}$ (3.3 V Version) (Note 5)	150 150	- -	500 500	mA
Short Circuit Current Limit	$I_{OUT(SC)}$	$V_{OUT} = 0\text{ V}$ (Note 5)	40	-	500	mA
Thermal Shutdown Threshold	T_{TSD}	(Note 7)	150	-	200	°C

Product parametric performance is indicated in the Electrical Characteristics for the listed test conditions, unless otherwise noted. Product performance may not be indicated by the Electrical Characteristics if operated under different conditions.

4. 1 oz., 100 mm² copper area.

5. Use pulse loading to limit power dissipation.

6. Dropout voltage = $(V_{IN} - V_{OUT})$, measured when the output voltage has dropped 100 mV relative to the nominal value obtained with $V_{IN} = 13.5\text{ V}$.

7. Not tested in production. Limits are guaranteed by design.

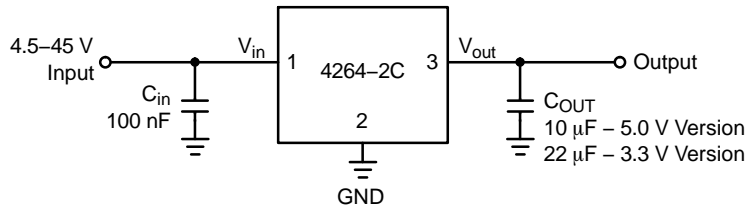

Figure 2. Applications Circuit

TYPICAL CHARACTERISTIC CURVES – 5 V Version

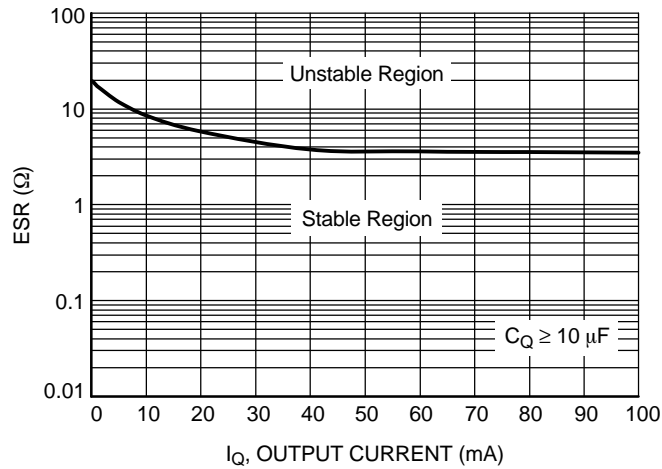

Figure 3. Output Stability with Output Capacitor ESR (5.0 V Version)

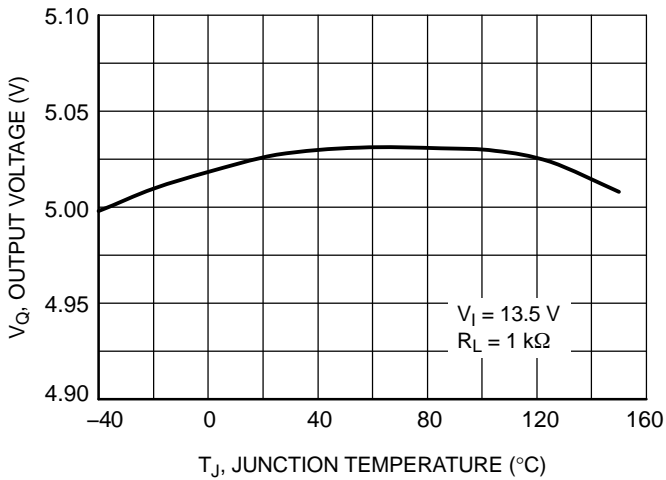

Figure 4. Output Voltage vs. Junction Temperature (5.0 V Version)

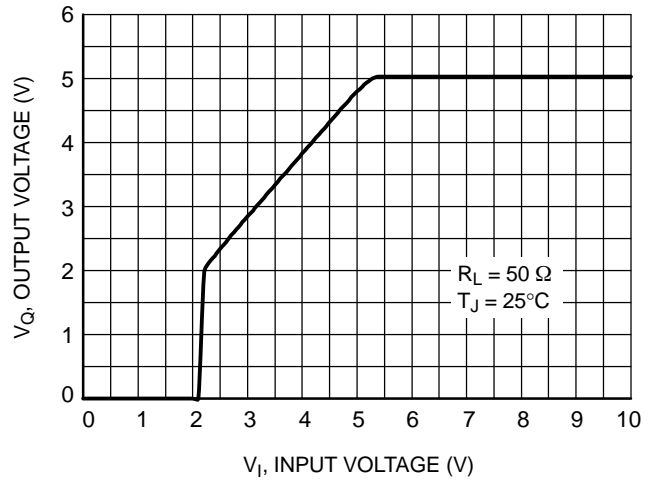

Figure 5. Output Voltage vs. Input Voltage (5.0 V Version)

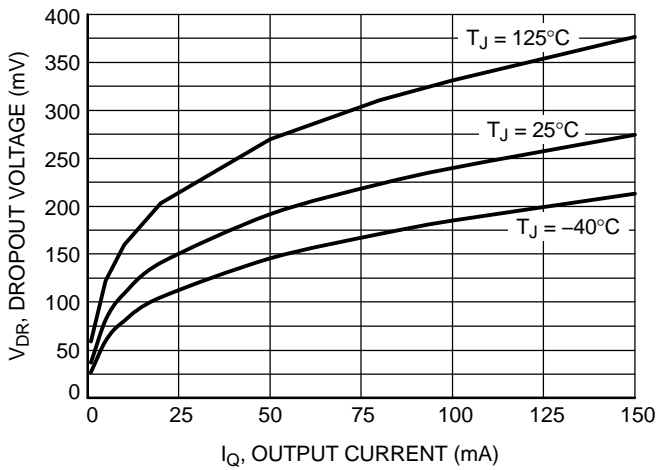

Figure 6. Dropout Voltage vs. Output Current (only 5.0 V Version)

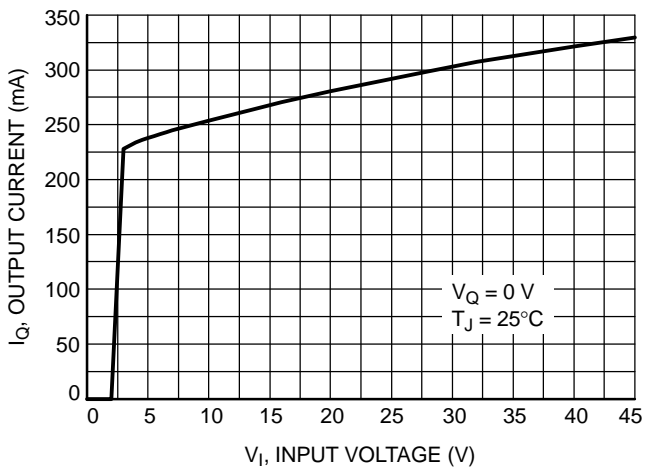

Figure 7. Maximum Output Current vs. Input Voltage (5.0 V Version)

TYPICAL CHARACTERISTIC CURVES – 5 V Version

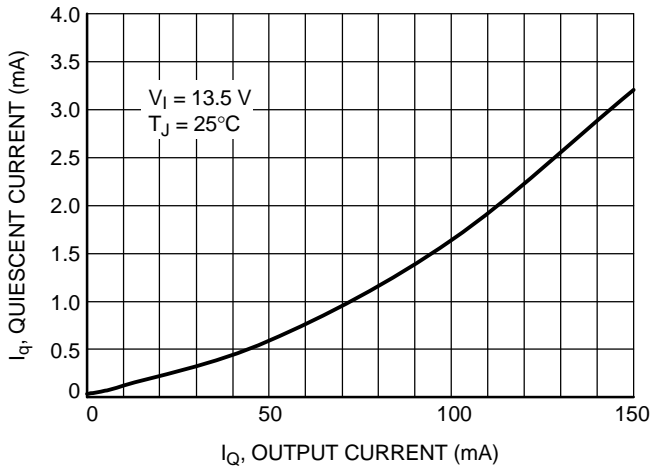

Figure 8. Quiescent Current vs. Output Current (5.0 V Version) (High Load)

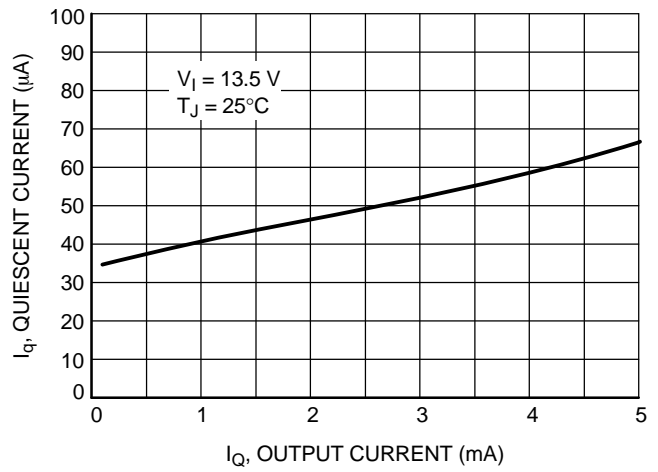

Figure 9. Quiescent Current vs. Output Current (5.0 V Version) (Low Load)

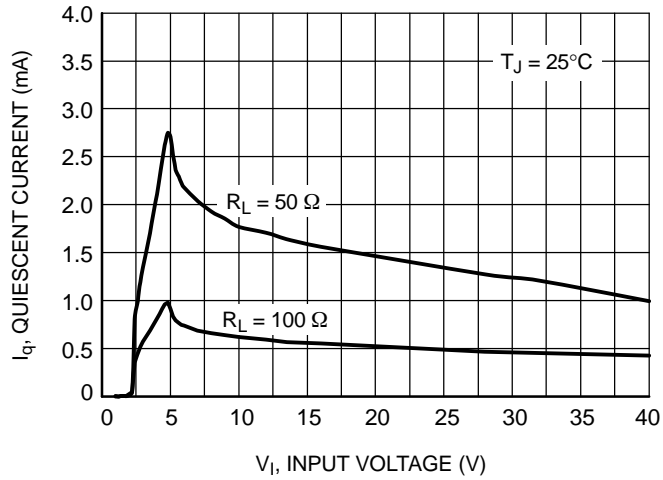

Figure 10. Quiescent Current vs. Input Voltage (5.0 V Version)

TYPICAL CHARACTERISTIC CURVES – 3.3 V Version

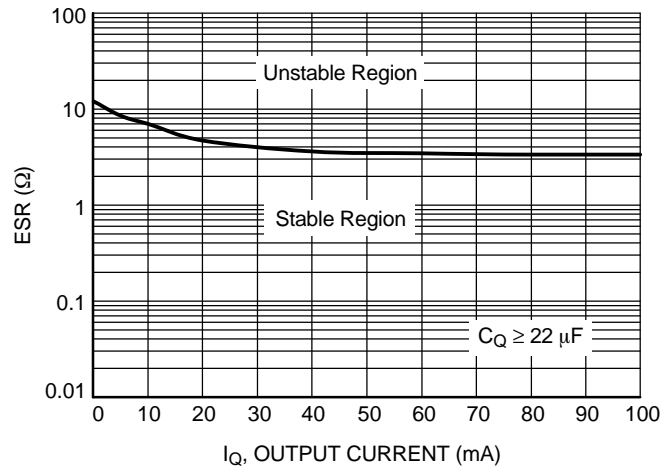

Figure 11. Output Stability with Output Capacitor ESR (3.3 V Version)

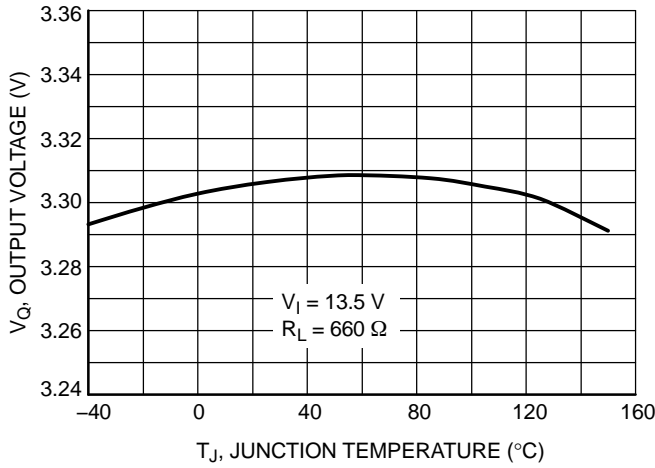

Figure 12. Output Voltage vs. Junction Temperature (3.3 V Version)

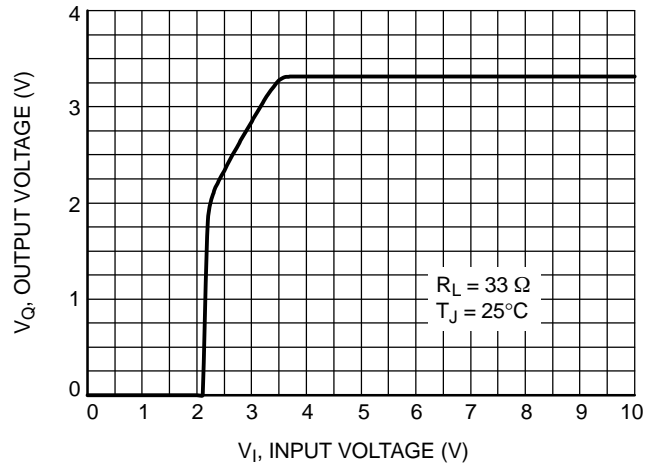

Figure 13. Output Voltage vs. Input Voltage (3.3 V Version)

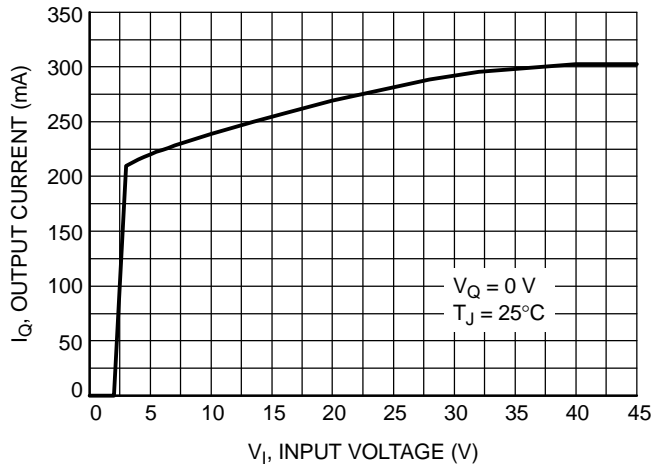

Figure 14. Maximum Output Current vs. Input Voltage (3.3 V Version)

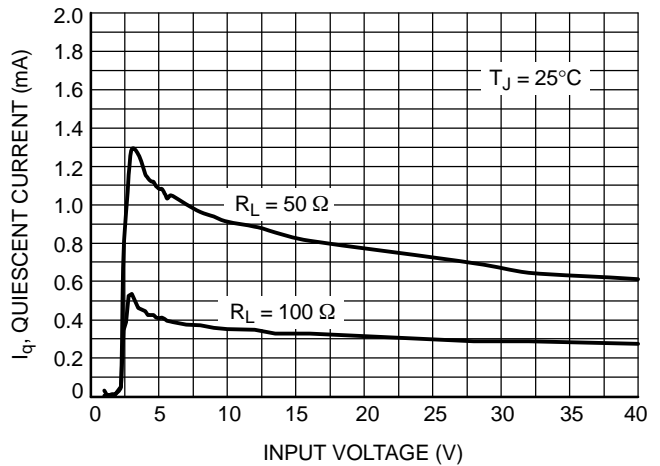

Figure 15. Quiescent Current vs. Input Voltage (3.3 V Version)

TYPICAL CHARACTERISTIC CURVES – 3.3 V Version

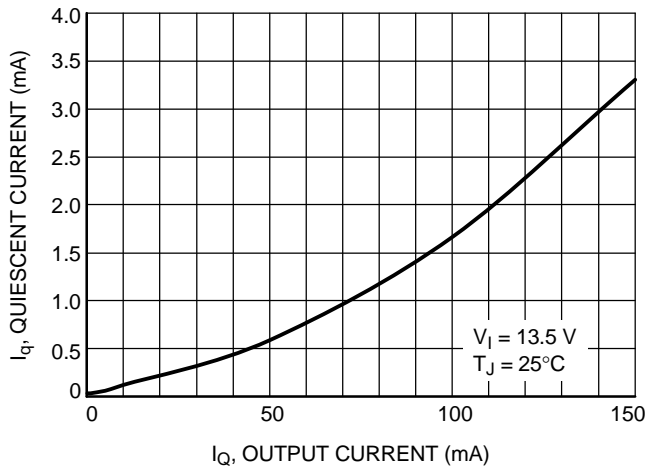

Figure 16. Quiescent Current vs. Output Current (3.3 V Version) (High Load)

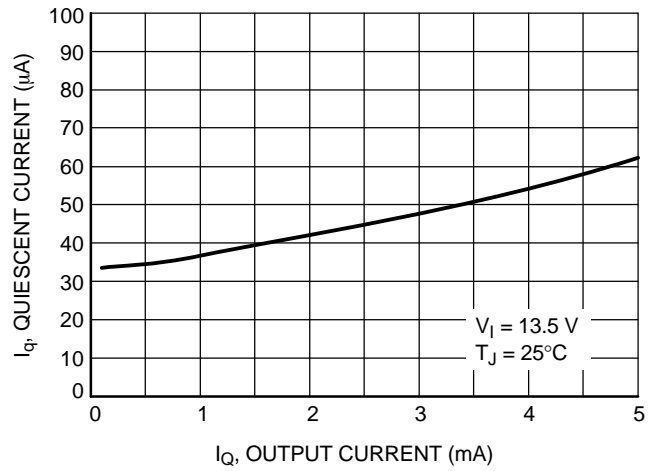

Figure 17. Quiescent Current vs. Output Current (3.3 V Version) (Low Load)

Circuit Description

The NCV4264–2C is a low quiescent current consumption LDO regulator. Its output stage supplies 100 mA with ±2.0% output voltage accuracy.

Maximum dropout voltage is 500 mV at 100 mA load current. It is internally protected against 45 V input transients, input supply reversal, output overcurrent faults, and excess die temperature. No external components are required to enable these features.

Regulator

The error amplifier compares the reference voltage to a sample of the output voltage (V_{OUT}) and drives the base of a PNP series pass transistor by a buffer. The reference is a bandgap design to give it a temperature–stable output. Saturation control of the PNP is a function of the load current and input voltage. Oversaturation of the output power device is prevented, and quiescent current in the ground pin is minimized.

Regulator Stability Considerations

The input capacitor C_{I1} in Figure 2 is necessary for compensating input line reactance. Possible oscillations caused by input inductance and input capacitance can be damped by using a resistor of approximately 1 Ω in series with C_{I2}. The output or compensation capacitor, C_{OUT} helps determine three main characteristics of a linear regulator: startup delay, load transient response and loop stability. Tantalum, aluminum electrolytic, film, or ceramic capacitors are all acceptable solutions, however, attention must be paid to ESR constraints. The capacitor manufacturer’s data sheet usually provides this information. The value for the output capacitor C_{OUT} shown in Figure 2 should work for most applications; however, it is not necessarily the optimized solution. Stability is guaranteed at values of C_Q ≥ 10 μF, with an ESR ≤ 3.5 Ω for the 5.0 V Version, and C_Q ≥ 22 μF with an ESR ≤ 3.35 Ω for the 3.3 V Version within the operating temperature range. Actual limits are shown in a graph in the Typical Performance Characteristics section.

Calculating Power Dissipation in a Single Output Linear Regulator

The maximum power dissipation for a single output regulator (Figure 3) is:

$$P_{D(max)} = [V_{IN(max)} - V_{OUT(min)}] * I_{Q(max)} + V_{I(max)} * I_Q \tag{eq. 1}$$

Where:

V_{IN(max)} is the maximum input voltage,

V_{OUT(min)} is the minimum output voltage,

I_{Q(max)} is the maximum output current for the application, and I_Q is the quiescent current the regulator consumes at I_{Q(max)}. Once the value of P_{D(max)} is known, the maximum permissible value of R_{θJA} can be calculated:

$$P_{\theta JA} = \frac{(150^\circ C - T_A)}{P_D} \tag{eq. 2}$$

The value of R_{θJA} can then be compared with those in the package section of the data sheet. Those packages with R_{θJA}’s less than the calculated value in Equation 2 will keep the die temperature below 150°C. In some cases, none of the packages will be sufficient to dissipate the heat generated by the IC, and an external heat sink will be required. The current flow and voltages are shown in the Measurement Circuit Diagram.

Heat Sinks

A heat sink effectively increases the surface area of the package to improve the flow of heat away from the IC and into the surrounding air. Each material in the heat flow path between the IC and the outside environment will have a thermal resistance. Like series electrical resistances, these resistances are summed to determine the value of R_{θJA}:

$$R_{\theta JA} = R_{\theta JC} + R_{\theta CS} + R_{\theta SA} \tag{eq. 3}$$

Where:

R_{θJC} = the junction–to–case thermal resistance,

R_{θCS} = the case–to–heat sink thermal resistance, and

R_{θSA} = the heat sink–to–ambient thermal resistance.

R_{θJC} appears in the package section of the data sheet. Like R_{θJA}, it too is a function of package type. R_{θCS} and R_{θSA} are functions of the package type, heatsink and the interface between them. These values appear in data sheets of heatsink manufacturers.

Thermal, mounting, and heat sinking are discussed in the ON Semiconductor application note AN1040/D, available on the ON Semiconductor Website.

NCV4264-2C

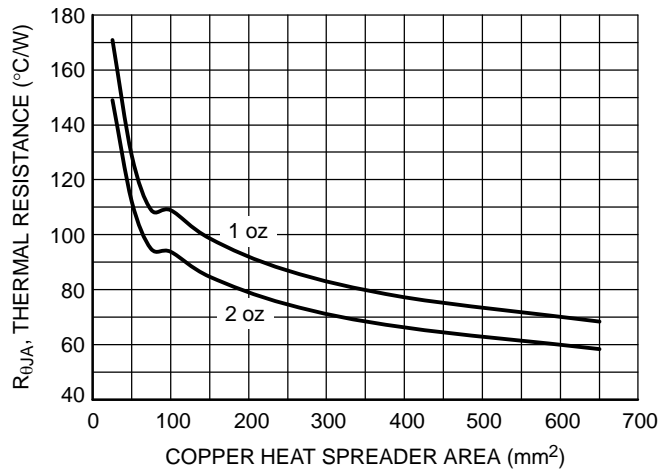

Figure 18. R_{θJA} vs. Copper Spreader Area

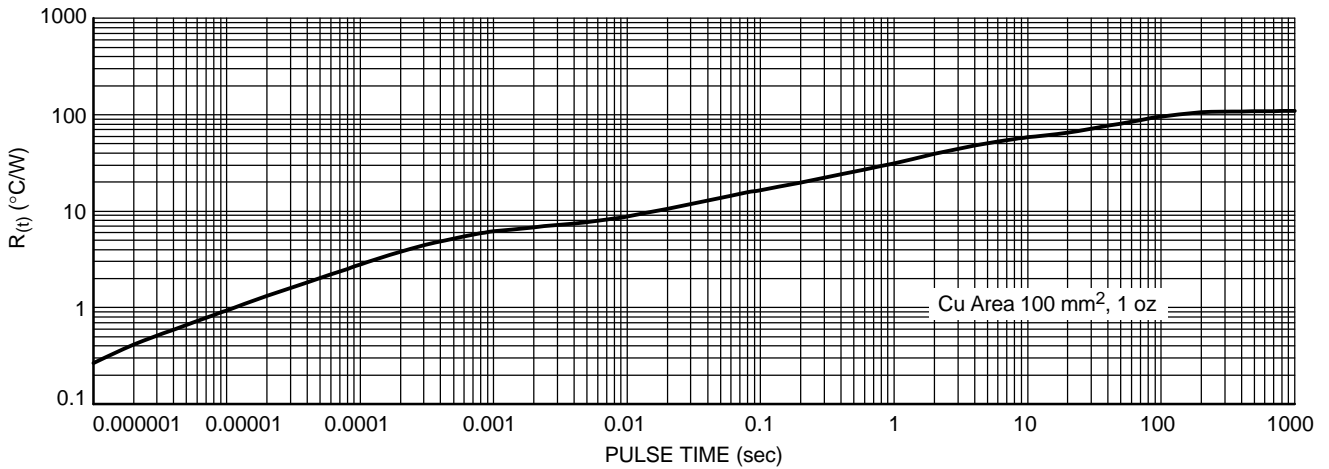

Figure 19. Single Pulse Heating Curve

ORDERING INFORMATION

Device	Package	Shipping†
NCV4264-2CST50T3G	SOT-223 (Pb-Free)	4000 / Tape & Reel
NCV4264-2CST33T3G	SOT-223 (Pb-Free)	4000 / Tape & Reel

†For information on tape and reel specifications, including part orientation and tape sizes, please refer to our Tape and Reel Packaging Specification Brochure, BRD8011/D.

NCV4264-2C

PACKAGE DIMENSIONS

SOT-223 (TO-261)
CASE 318E-04
ISSUE N

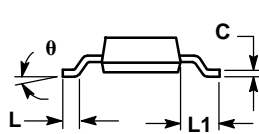
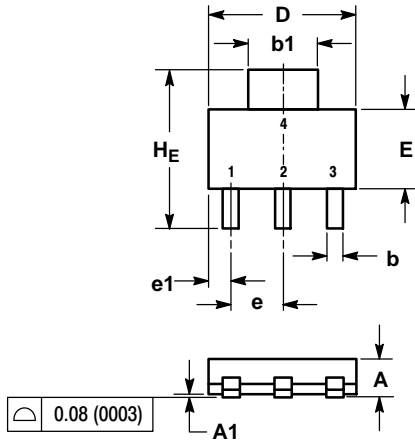

NOTES:
1. DIMENSIONING AND TOLERANCING PER ASME Y14.5M, 1994.
2. CONTROLLING DIMENSION: INCH.

DIM	MILLIMETERS			INCHES		
	MIN	NOM	MAX	MIN	NOM	MAX
A	1.50	1.63	1.75	0.060	0.064	0.068
A1	0.02	0.06	0.10	0.001	0.002	0.004
b	0.60	0.75	0.89	0.024	0.030	0.035
b1	2.90	3.06	3.20	0.115	0.121	0.126
c	0.24	0.29	0.35	0.009	0.012	0.014
D	6.30	6.50	6.70	0.249	0.256	0.263
E	3.30	3.50	3.70	0.130	0.138	0.145
e	2.20	2.30	2.40	0.087	0.091	0.094
e1	0.85	0.94	1.05	0.033	0.037	0.041
L	0.20	—	—	0.008	—	—
L1	1.50	1.75	2.00	0.060	0.069	0.078
HE	6.70	7.00	7.30	0.264	0.276	0.287
θ	0°	—	10°	0°	—	10°

SOLDERING FOOTPRINT

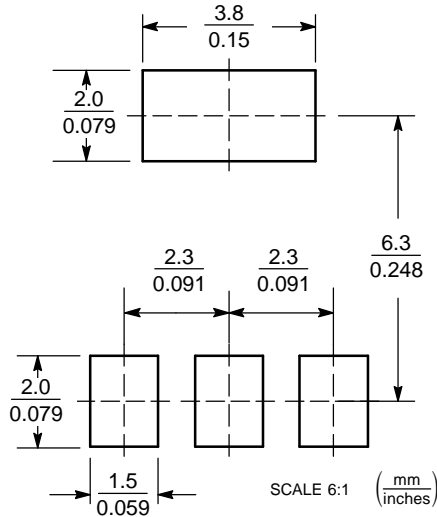

ON Semiconductor and are registered trademarks of Semiconductor Components Industries, LLC (SCILLC). SCILLC owns the rights to a number of patents, trademarks, copyrights, trade secrets, and other intellectual property. A listing of SCILLC's product/patent coverage may be accessed at www.onsemi.com/site/pdf/Patent-Marketing.pdf. SCILLC reserves the right to make changes without further notice to any products herein. SCILLC makes no warranty, representation or guarantee regarding the suitability of its products for any particular purpose, nor does SCILLC assume any liability arising out of the application or use of any product or circuit, and specifically disclaims any and all liability, including without limitation special, consequential or incidental damages. "Typical" parameters which may be provided in SCILLC data sheets and/or specifications can and do vary in different applications and actual performance may vary over time. All operating parameters, including "Typicals" must be validated for each customer application by customer's technical experts. SCILLC does not convey any license under its patent rights nor the rights of others. SCILLC products are not designed, intended, or authorized for use as components in systems intended for surgical implant into the body, or other applications intended to support or sustain life, or for any other application in which the failure of the SCILLC product could create a situation where personal injury or death may occur. Should Buyer purchase or use SCILLC products for any such unintended or unauthorized application, Buyer shall indemnify and hold SCILLC and its officers, employees, subsidiaries, affiliates, and distributors harmless against all claims, costs, damages, and expenses, and reasonable attorney fees arising out of, directly or indirectly, any claim of personal injury or death associated with such unintended or unauthorized use, even if such claim alleges that SCILLC was negligent regarding the design or manufacture of the part. SCILLC is an Equal Opportunity/Affirmative Action Employer. This literature is subject to all applicable copyright laws and is not for resale in any manner.

PUBLICATION ORDERING INFORMATION

LITERATURE FULFILLMENT:
Literature Distribution Center for ON Semiconductor
P.O. Box 5163, Denver, Colorado 80217 USA
Phone: 303-675-2175 or 800-344-3860 Toll Free USA/Canada
Fax: 303-675-2176 or 800-344-3867 Toll Free USA/Canada
Email: orderlit@onsemi.com

N. American Technical Support: 800-282-9855 Toll Free
USA/Canada
Europe, Middle East and Africa Technical Support:
Phone: 421 33 790 2910
Japan Customer Focus Center
Phone: 81-3-5817-1050

ON Semiconductor Website: www.onsemi.com
Order Literature: <http://www.onsemi.com/orderlit>
For additional information, please contact your local Sales Representative