

百盛新纪元半导体  
 电话：13534212799  
 Q Q：2851339680

## 300mA, Low Noise High PSRR LDO Regulator

### Description

The FP6185 is a low dropout, low noise, high PSRR, very low quiescent current positive linear regulator. The FP6185 can supply 300mA output current with low dropout voltage at about 400mV that optimized for battery-powered systems or portable wireless devices such as mobile phones. The shutdown function can provide remote control for the external signal to decide the on/off state of FP6185 that consumes less than 0.1 $\mu$ A during shutdown mode.

The FP6185 regulator is able to operate with output capacitors as small as 1 $\mu$ F for stability. Other than the current limit protection, FP6185 also offers the on chip thermal shutdown feature providing protection against overload or any condition when the ambient temperature exceeds the maximum junction temperature.

The FP6185 offers high precision output voltage of  $\pm 2\%$ . The FP6185 is available in SOT-23-5 package which features small size.

### Features

- Low  $V_{IN}$  and Wide  $V_{IN}$  Range: 2V to 5.5V
- Output Current 300mA<sup>\*1</sup>
- $\pm 2\%$  Output Voltage Accuracy
- Output Noise 65 $\mu$ Vrms from 10Hz to 100kHz
- $V_{OUT}$  Fixed 1.0V to 3.3V
- Low Dropout Voltage of 400mV at 300mA
- Ripple Rejection 75dB at 1KHz
- Very Low Quiescent Current at 35 $\mu$ A
- Needs Only 1 $\mu$ F Capacitor for Stability
- Thermal Shutdown Protection
- Current Limit Protection
- SOT-23-5 Package
- RoHS Compliant

\*

1. Attention should be paid to the power dissipation of the package when the output current is large.

### Applications

- PDAs, Mobile phones, GPS, Smartphones
- Wireless Handsets, Wireless LAN, Bluetooth®, Zigbee®
- Portable Medical Equipment
- Other Battery Powered Applications

**Pin Assignment**

S5 Package (SOT-23-5)

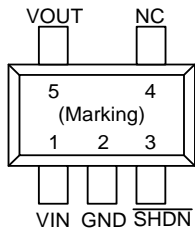
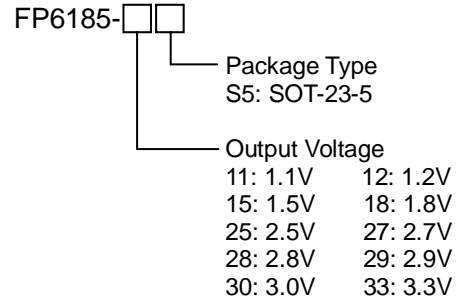

Figure 1. Pin Assignment of FP6185

**Ordering Information**



**Marking Information**

Part Number	Product Code
FP6185-11S5	FU4
FP6185-12S5	FD8
FP6185-15S5	FD9
FP6185-18S5	FE1
FP6185-25S5	FU5
FP6185-27S5	FU6
FP6185-28S5	FE3
FP6185-29S5	FE2
FP6185-30S5	FU7
FP6185-33S5	FE4

Note: Please consult Fitipower sales office or authorized distributors for availability of special output voltages.

## Typical Application Circuit

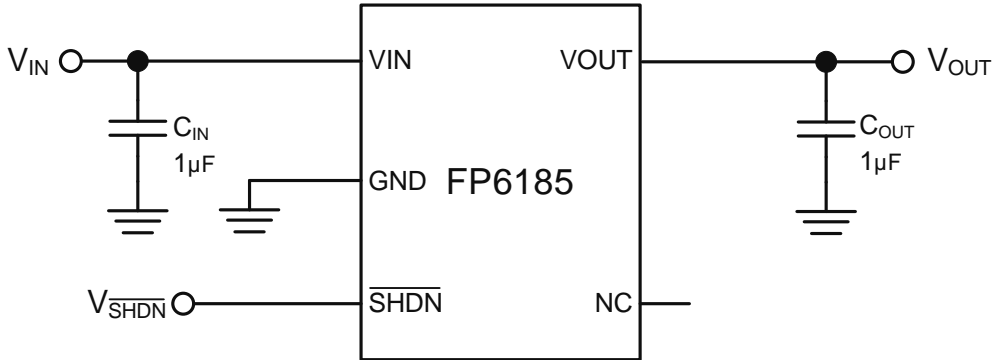

Figure 2. Typical Application Circuit of FP6185

Note: To prevent oscillation, it is recommended to use minimum 1μF X7R or X5R dielectric capacitors if ceramics are used as input/output capacitors.

## Functional Pin Description

Pin Name	Pin No.	Pin Function
VIN	1	Power is supplied to this device from this pin which is required an input filter capacitor. In general, the input capacitor in the range of 1μF to 10μF is sufficient.
GND	2	Common ground pin.
$\overline{\text{SHDN}}$	3	Pull this pin high to enable IC, pull this pin low to shutdown IC. Floating this pin will be shutdown due to the built-in pull-low resistor.
NC	4	No connection.
VOUT	5	The FP6185 is stable with an output capacitor 1μF or greater. The larger output capacitor will be required for application with larger load transients. The large output capacitor could reduce output noise, improve stability and PSRR.

## Block Diagram

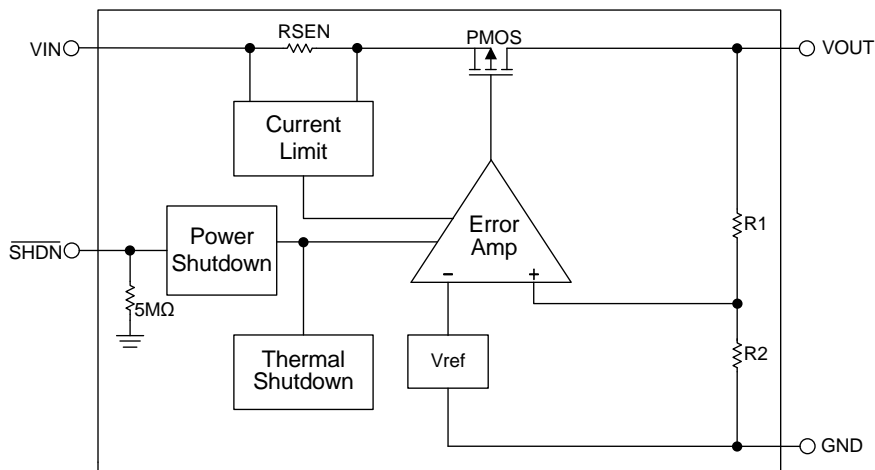

Figure 3. Block Diagram of FP6185

## Absolute Maximum Ratings <sup>(Note 1)</sup>

- Supply Voltage  $V_{IN}$  ----- -0.3V to +6.5V
- EN Voltage  $V_{EN}$  ----- -0.3V to  $V_{IN}+0.3V$
- Power Dissipation @  $T_A=25^{\circ}C$  &  $T_J=125^{\circ}C$  ( $P_D$ )
  - SOT-23-5 ----- 0.4W
- Package Thermal Resistance ( $\theta_{JA}$ ) <sup>(Note 2)</sup>
  - SOT-23-5 ----- 250°C/W
- Package Thermal Resistance ( $\theta_{JC}$ )
  - SOT-23-5 ----- 130°C/W
- Lead Temperature (Soldering, 10sec.) ----- +260°C
- Junction Temperature ( $T_J$ ) ----- -40°C to +150°C
- Storage Temperature ( $T_{STG}$ ) ----- -65°C to +150°C

Note 1: Stresses beyond this listed under "Absolute Maximum Ratings" may cause permanent damage to the device.

Note 2:  $\theta_{JA}$  is measured at 25°C ambient with the component mounted on a high effective thermal conductivity 4-layer board of JEDEC-51-7. The thermal resistance greatly varies with layout, copper thickness, number of layers and PCB size.

## Recommended Operating Conditions

- VIN Supply Voltage ----- +2V to +5.5V
- Output Current ( $I_{OUT}$ ) ----- 0mA to 300mA
- Operating Temperature Range ( $T_{OPR}$ ) ----- -40°C to +85°C
- Operating Junction Temperature Range ( $T_J$ ) ----- -40°C to +125°C

## Electrical Characteristics

( $V_{IN}=V_{OUT}+1V$ ,  $\overline{SHDN}$  pin connected to  $V_{IN}$ ,  $C_{IN}=1\mu F$ ,  $C_{OUT}=1\mu F$ ,  $T_A=25^\circ C$ , unless otherwise specified)

Parameter	Symbol	Conditions	Min	Typ	Max	Unit	
Input Voltage Range	$V_{IN}$		2		5.5	V	
Current Limit	$I_{LIMIT}$	$R_{Load}=1\Omega$	320			mA	
Quiescent Current	$I_Q$	$I_{OUT}=0mA$		35		$\mu A$	
Standby Current	$I_{STBY}$	$\overline{SHDN}$ Pin Connected to GND		0.1	1	$\mu A$	
Output Voltage Accuracy	$\Delta V_{OUT}$	$I_{OUT}=1mA$	-2		+2	%	
Dropout Voltage (Note 3)	$V_{DROP}$	$I_{OUT}=150mA$	$V_{OUT}=1.2V$		800	1200	mV
			$V_{OUT}=1.5V$		600	900	
			$V_{OUT}=1.8V$		475	700	
			$V_{OUT}=2.5V$		275	400	
			$V_{OUT}=2.7V$		250	350	
			$V_{OUT}=3.0V$		225	325	
			$V_{OUT}=3.3V$		200	300	
Dropout Voltage (Note 3)	$V_{DROP}$	$I_{OUT}=300mA$	$V_{OUT}=1.2V$		1550	2300	mV
			$V_{OUT}=1.5V$		950	1400	
			$V_{OUT}=1.8V$		750	1100	
			$V_{OUT}=2.5V$		550	800	
			$V_{OUT}=2.7V$		500	700	
			$V_{OUT}=3.0V$		450	650	
			$V_{OUT}=3.3V$		400	600	
Line Regulation	$\Delta V_{LINE}$	$I_{OUT}=1mA$ , $V_{IN}=V_{OUT}+1V$ to 5V		1	8	mV	
Load Regulation (Note 4)	$\Delta V_{LOAD}$	$I_{OUT}=0mA$ to 300mA		6	30	mV	
Ripple Rejection (Note 5)	PSRR	$V_{IN}=V_{OUT}+1V_{DC}+0.2V_{P-P(AC)}$ , $f_{RIPPLE}=1KHz$ , $V_{OUT}\geq 1.8V$ , $I_{OUT}=30mA$		75		dB	
Output Noise Voltage (Note 5)	$V_{NOISE}$	$C_{OUT}=1\mu F$ , $I_{OUT}=0mA$ $BW=10Hz \sim 100KHz$		65		$\mu V_{RMS}$	
Temperature Coefficient (Note 5)	TC	$I_{OUT}=1mA$ , $V_{IN}=5V$		100		ppm/ $^\circ C$	
Thermal Shutdown Threshold (Note 5)	$T_{SD}$			145		$^\circ C$	
	$\Delta T_{SD}$	Hysteresis		25		$^\circ C$	
Output Discharge Resistance	$R_{DIS}$	$V_{\overline{SHDN}}=0V$		60		$\Omega$	
$\overline{SHDN}$ Pin Current	$I_{\overline{SHDN}}$	$V_{\overline{SHDN}}=2.5V$		0.3		$\mu A$	

## Electrical Characteristics (Continued)

( $V_{IN}=V_{OUT}+1V$ ,  $\overline{SHDN}$  pin connected to  $V_{IN}$ ,  $C_{IN}=1\mu F$ ,  $C_{OUT}=1\mu F$ ,  $T_A=25^\circ C$ , unless otherwise specified)

Parameter	Symbol	Conditions	Min	Typ	Max	Unit
$\overline{SHDN}$ Pin Threshold	$V_{\overline{SHDN}(ON)}$	Start-up	1.0			V
	$V_{\overline{SHDN}(OFF)}$	Shutdown			0.4	V

Note 3: The dropout voltage is defined as  $V_{IN}-V_{OUT}$ , which is measured when  $V_{OUT}$  drops 2% of its normal value with the specified output current.

Note 4: Load regulation and dropout voltage are measured at a constant junction temperature by using a 40ms low duty cycle current pulse.

Note 5: Guarantee by design.

### Typical Performance Curves

$V_{IN}=V_{OUT}+1V$ ,  $\overline{SHDN}$  pin connected to  $V_{IN}$ ,  $C_{IN}=1\mu F$ ,  $C_{OUT}=1\mu F$ ,  $T_A=25^\circ C$ , unless otherwise specified

$V_{OUT}=3.3V$ ,  $I_{OUT}=0mA$

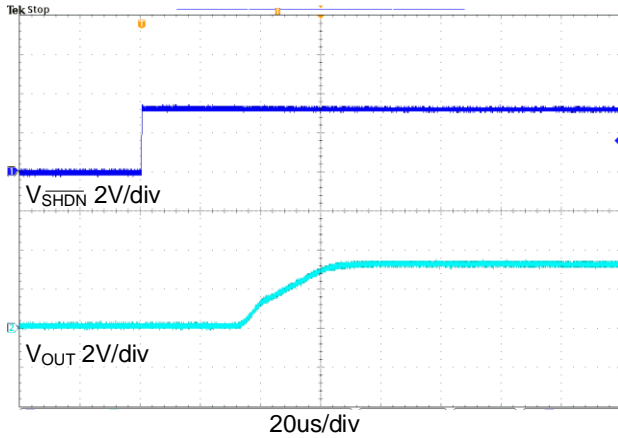

Figure 4. Turn ON Waveform

$V_{OUT}=3.3V$ ,  $I_{OUT}=0mA$

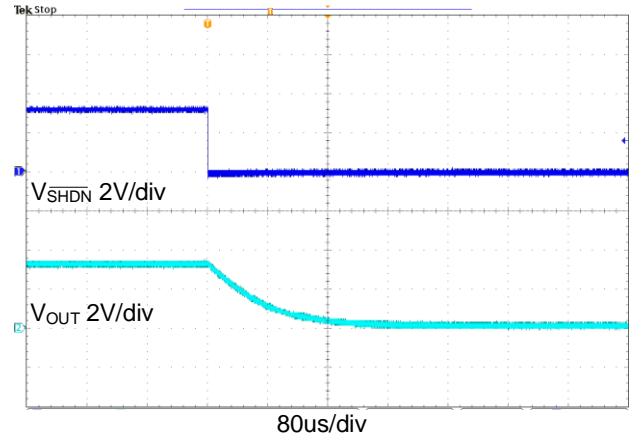

Figure 5. Turn OFF Waveform

$V_{OUT}=1.5V$ ,  $I_{OUT}=0mA$

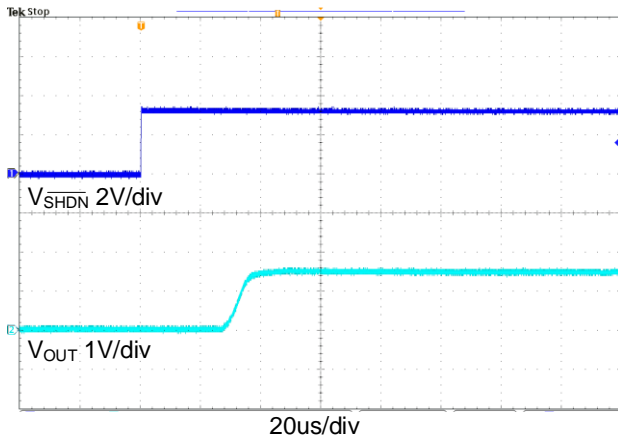

Figure 6. Turn ON Waveform

$V_{OUT}=1.5V$ ,  $I_{OUT}=0mA$

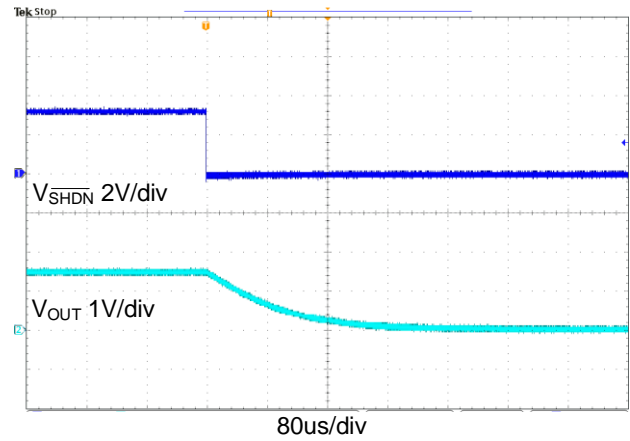

Figure 7. Turn OFF Waveform

$3.3V_{OUT}/I_{OUT}=1mA \rightarrow 300mA \rightarrow 1mA$

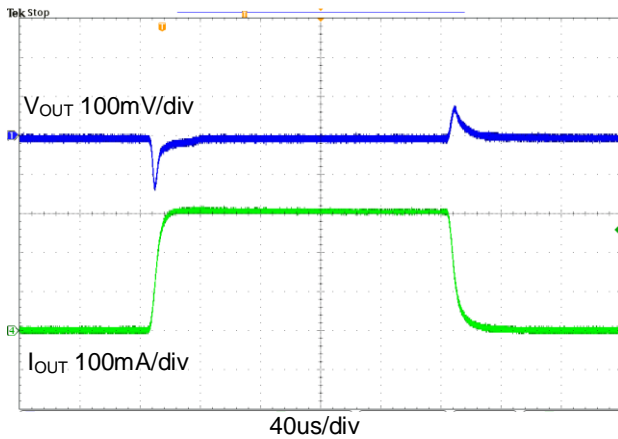

Figure 8. Load Transient Response

$1.5V_{OUT}/I_{OUT}=1mA \rightarrow 300mA \rightarrow 1mA$

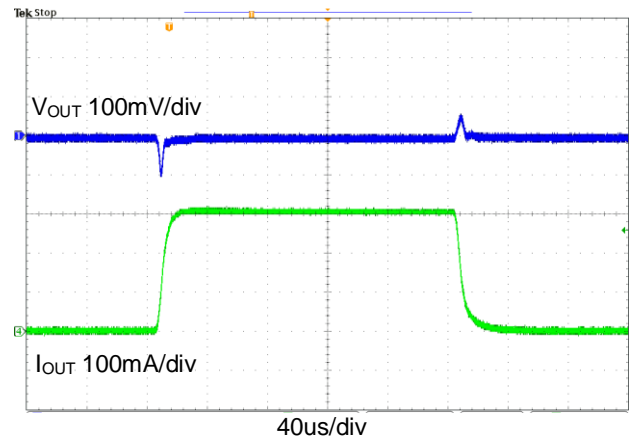

Figure 9. Load Transient Response

Typical Performance Curves (Continued)

$V_{IN}=V_{OUT}+1V$ ,  $\overline{SHDN}$  pin connected to  $V_{IN}$ ,  $C_{IN}=1\mu F$ ,  $C_{OUT}=1\mu F$ ,  $T_A=25^\circ C$ , unless otherwise specified

$V_{OUT}=3.3V/10mA$ ,  $C_{IN}=none$

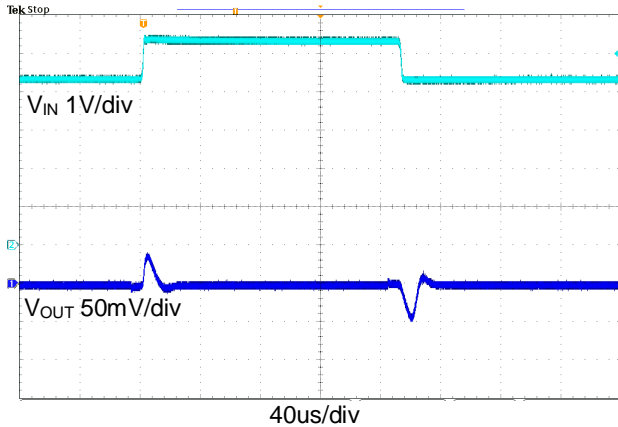

Figure 10. Line Transient Response

$V_{OUT}=1.5V/10mA$ ,  $C_{IN}=none$

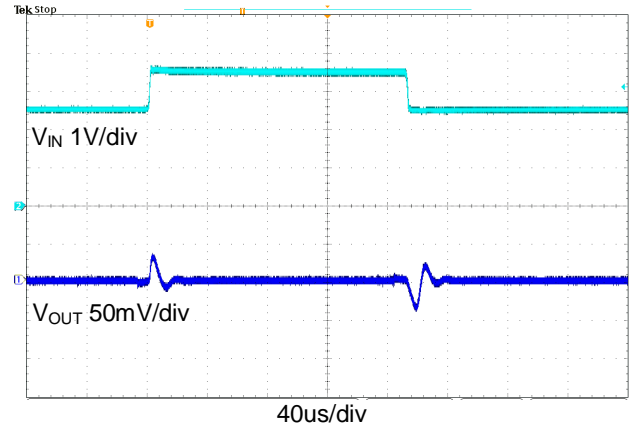

Figure 11. Line Transient Response

$I_{OUT}=1mA$

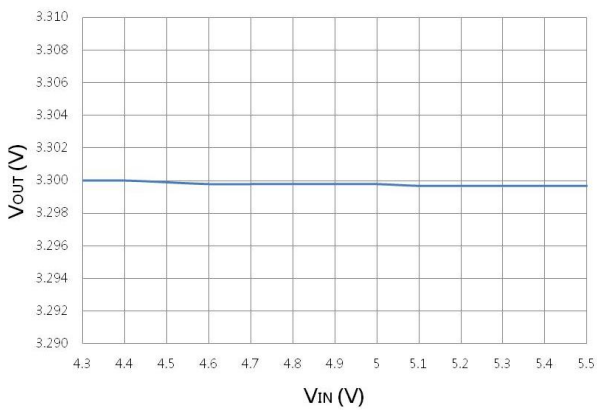

Figure 12. Output Voltage vs. Input Voltage

$I_{OUT}=1mA$

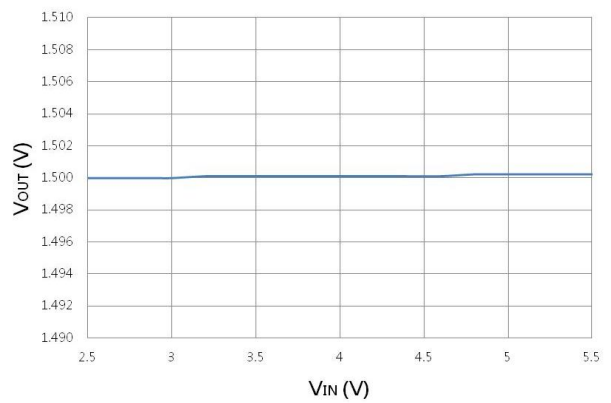

Figure 13. Output Voltage vs. Input Voltage

$V_{IN}=5V$

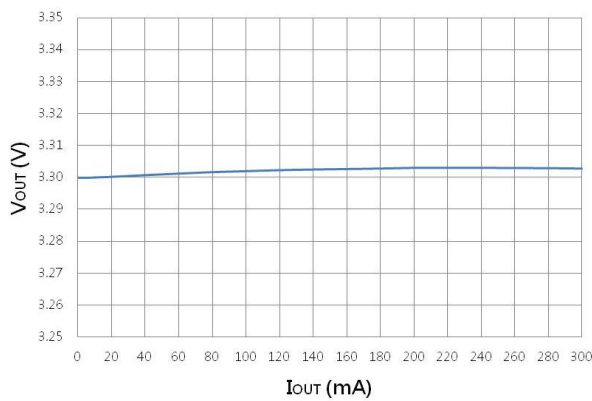

Figure 14. Output Voltage vs. Output Current

$V_{IN}=3.3V$

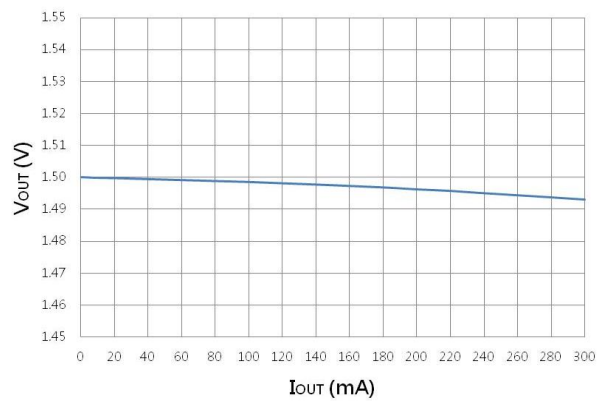

Figure 15. Output Voltage vs. Output Current



Typical Performance Curves (Continued)

$V_{IN}=V_{OUT}+1V$ ,  $\overline{SHDN}$  pin connected to  $V_{IN}$ ,  $C_{IN}=1\mu F$ ,  $C_{OUT}=1\mu F$ ,  $T_A=25^\circ C$ , unless otherwise specified

$V_{OUT}=3.3V$

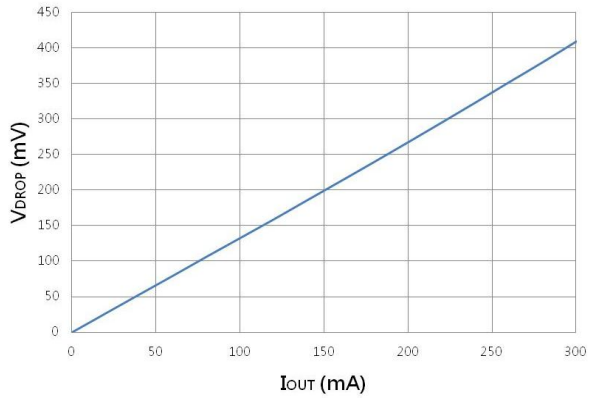

Figure 16. Dropout Voltage vs. Output Current

$V_{OUT}=1.5V$

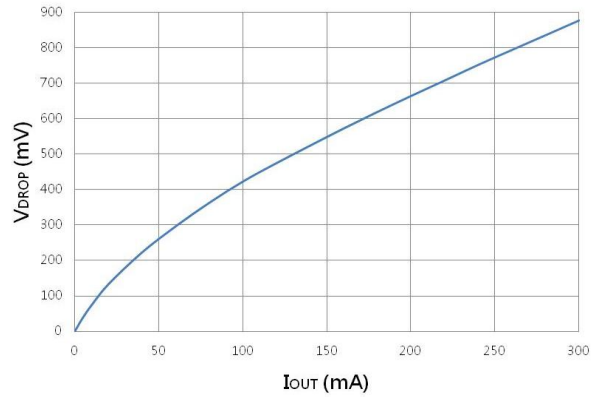

Figure 17. Dropout Voltage vs. Output Current

$I_{OUT}=1mA$

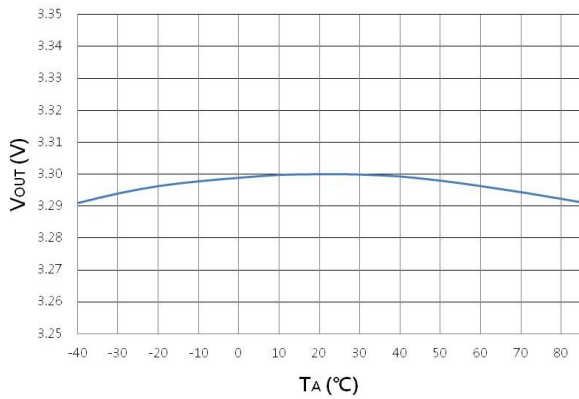

Figure 18. Output Voltage vs. Temperature

$I_{OUT}=1mA$

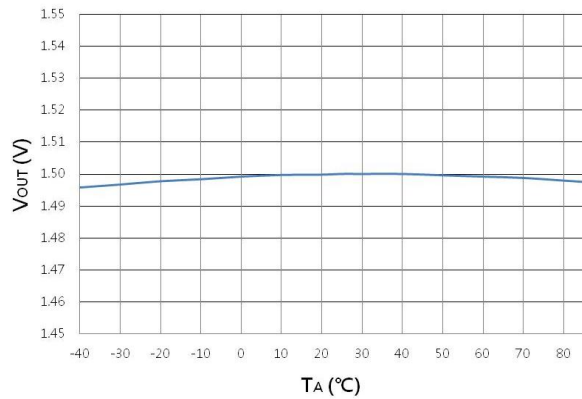

Figure 19. Output Voltage vs. Temperature

$V_{IN}=4.3V$ ,  $V_{OUT}=3.3V$

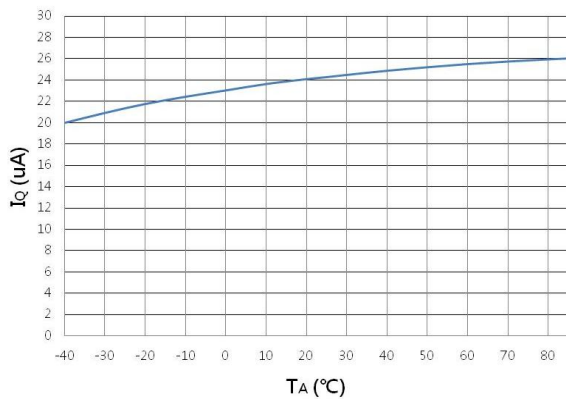

Figure 20. Quiescent Current vs. Temperature

$V_{IN}=2.5V$ ,  $V_{OUT}=1.5V$

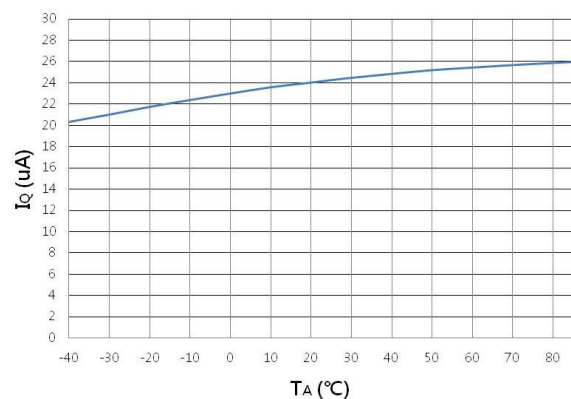

Figure 21. Quiescent Current vs. Temperature

Typical Performance Curves (Continued)

$V_{IN}=V_{OUT}+1V$ ,  $\overline{SHDN}$  pin connected to  $V_{IN}$ ,  $C_{IN}=1\mu F$ ,  $C_{OUT}=1\mu F$ ,  $T_A=25^\circ C$ , unless otherwise specified

$V_{OUT}=3.3V$ ,  $V_{SHDN}=0V$

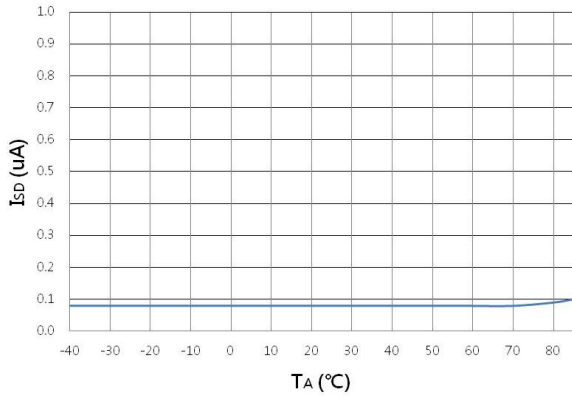

Figure 22. Shutdown Current vs. Temperature

$V_{OUT}=1.5V$ ,  $V_{SHDN}=0V$

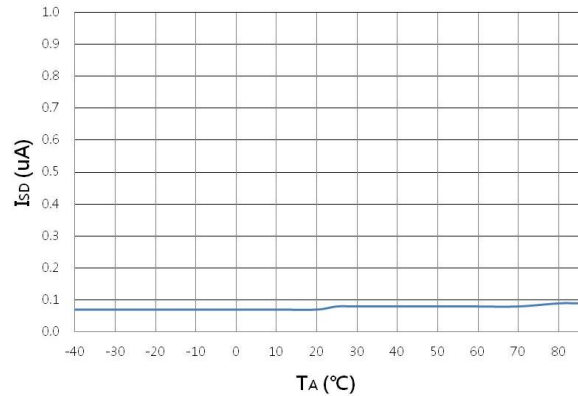

Figure 23. Shutdown Current vs. Temperature

$V_{OUT}=3.3V$ ,  $I_{OUT}=0mA$

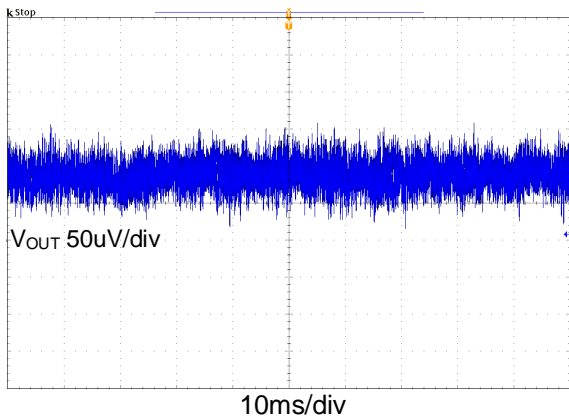

Figure 24. Output Noise Voltage

$V_{OUT}=1.5V$ ,  $I_{OUT}=0mA$

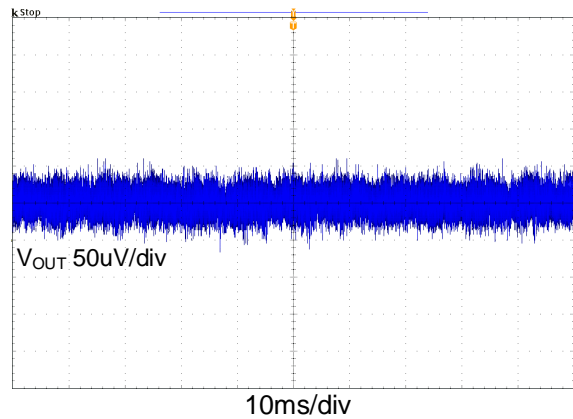

Figure 25. Output Noise Voltage

## Application Information

The FP6185 is a low dropout linear regulator that could provide 300mA output current at dropout voltage about 400mV. Current limit and on chip thermal shutdown features provide protection against any combination of overload or ambient temperature that could exceed maximum junction temperature.

### 1. Output and Input Capacitor

The FP6185 regulator is designed to be stable with a wide range of output capacitors. The ESR of the output capacitor affects stability. Larger value of the output capacitor decreases the peak deviations and improves transient response for larger current changes.

The capacitor types (aluminum, ceramic, and tantalum) have different characterizations such as temperature and voltage coefficients. All ceramic capacitors are manufactured with a variety of dielectrics, each with different behavior across temperature and applications. Common dielectrics used are X5R, X7R and Y5V. It is recommended to use 1 $\mu$ F to 10 $\mu$ F X5R or X7R dielectric ceramic capacitors with 30m $\Omega$  to 50m $\Omega$  ESR range between device outputs and ground for stability. The FP6185 is designed to be stable with low ESR ceramic capacitors and higher values of capacitors and ESR could improve output stability. The ESR of output capacitor is very important because it generates a zero to provide phase lead for loop stability.

There are no requirements for the ESR on the input capacitor, but its voltage and temperature coefficient have to be considered for device application environment.

### 2. Protection Features

In order to prevent overloading or thermal condition from damaging the device, FP6185 has internal thermal and current limiting functions designed to protect the device. It will rapidly shut off PMOS pass element during over-temperature condition.

### 3. Thermal Consideration

The power handling capability of the device will be limited by allowable operation junction temperature (125°C). The power dissipated by the device will be estimated by  $P_D = I_{OUT} \times (V_{IN} - V_{OUT})$ . The power dissipation should be lower than the maximum power dissipation listed in "Absolute Maximum Ratings" section.

### 4. Shutdown Operation

The FP6185 is shutdown by pulling the  $\overline{\text{SHDN}}$  input low, and turned on by driving the  $\overline{\text{SHDN}}$  high. If  $\overline{\text{SHDN}}$  pin floating, the FP6185 will shut down because  $\overline{\text{SHDN}}$  pin has built-in a pull low resistor (refer to Block Diagram).

Outline Information

SOT-23-5 Package (Unit: mm)

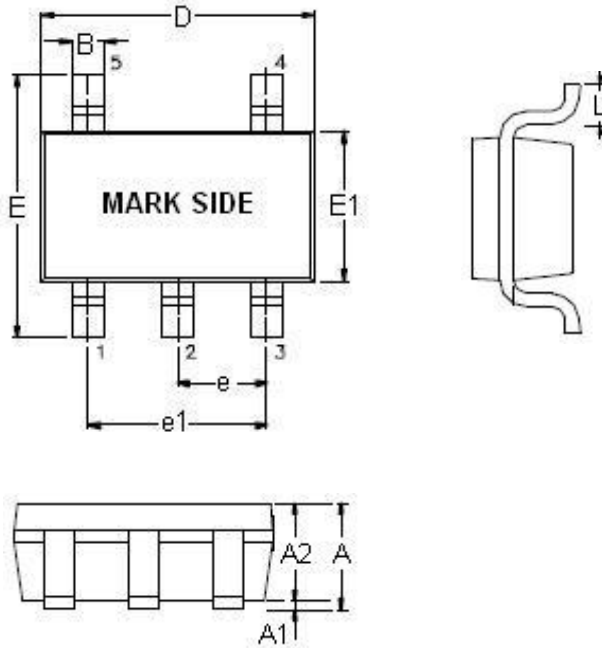

SYMBOLS UNIT	DIMENSION IN MILLIMETER	
	MIN	MAX
A	0.90	1.45
A1	0.00	0.15
A2	0.90	1.30
B	0.30	0.50
D	2.80	3.00
E	2.60	3.00
E1	1.50	1.70
e	0.90	1.00
e1	1.80	2.00
L	0.30	0.60

Note: Followed From JEDEC MO-178-C.

Carrier Dimensions

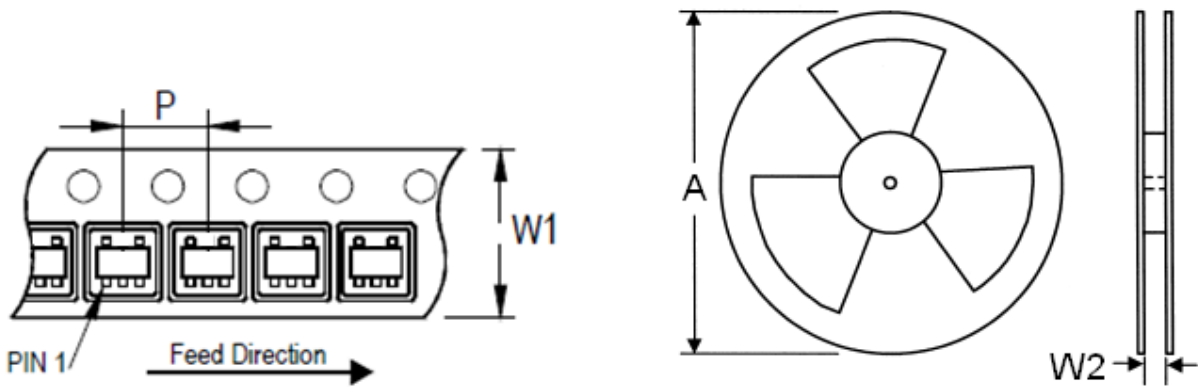

Tape Size (W1) mm	Pocket Pitch (P) mm	Reel Size (A)		Reel Width (W2) mm	Empty Cavity Length mm	Units per Reel
		in	mm			
8	4	7	180	8.4	300~1000	3,000

Life Support Policy

Fitipower's products are not authorized for use as critical components in life support devices or other medical systems.