

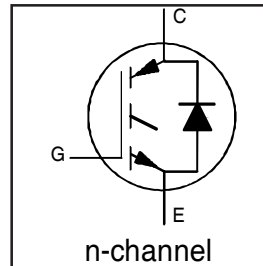
# IRG4BC30KDPbF

INSULATED GATE BIPOLAR TRANSISTOR WITH  
ULTRAFAST SOFT RECOVERY DIODE

Short Circuit Rated  
UltraFast IGBT

### Features

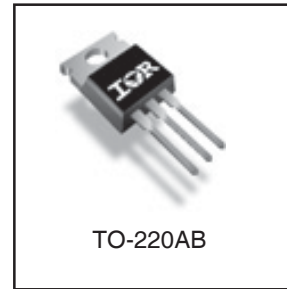
- High short circuit rating optimized for motor control,  $t_{sc} = 10\mu s$ , @360V  $V_{CE}$  (start),  $T_J = 125^\circ C$ ,  $V_{GE} = 15V$
- Combines low conduction losses with high switching speed
- tighter parameter distribution and higher efficiency than previous generations
- IGBT co-packaged with HEXFRED™ ultrafast, ultrasoft recovery antiparallel diodes
- Lead-Free



$V_{CES} = 600V$
$V_{CE(on)} \text{ typ.} = 2.21V$
@ $V_{GE} = 15V, I_C = 16A$

### Benefits

- Latest generation 4 IGBTs offer highest power density motor controls possible
- HEXFRED™ diodes optimized for performance with IGBTs. Minimized recovery characteristics reduce noise, EMI and switching losses
- This part replaces the IRGBC30KD2 and IRGBC30MD2 products
- For hints see design tip 97003



### Absolute Maximum Ratings

	Parameter	Max.	Units
$V_{CES}$	Collector-to-Emitter Voltage	600	V
$I_C @ T_C = 25^\circ C$	Continuous Collector Current	28	A
$I_C @ T_C = 100^\circ C$	Continuous Collector Current	16	
$I_{CM}$	Pulsed Collector Current ①	56	
$I_{LM}$	Clamped Inductive Load Current ②	56	
$I_F @ T_C = 100^\circ C$	Diode Continuous Forward Current	12	
$I_{FM}$	Diode Maximum Forward Current	58	
$t_{sc}$	Short Circuit Withstand Time	10	$\mu s$
$V_{GE}$	Gate-to-Emitter Voltage	$\pm 20$	V
$P_D @ T_C = 25^\circ C$	Maximum Power Dissipation	100	W
$P_D @ T_C = 100^\circ C$	Maximum Power Dissipation	42	
$T_J$	Operating Junction and	-55 to +150	$^\circ C$
$T_{STG}$	Storage Temperature Range		
	Soldering Temperature, for 10 sec.	300 (0.063 in. (1.6mm) from case)	
	Mounting Torque, 6-32 or M3 Screw.	10 lbf•in (1.1 N•m)	

### Thermal Resistance

	Parameter	Min.	Typ.	Max.	Units
$R_{\theta JC}$	Junction-to-Case - IGBT	---	---	1.2	$^\circ C/W$
$R_{\theta JC}$	Junction-to-Case - Diode	---	---	2.5	
$R_{\theta CS}$	Case-to-Sink, flat, greased surface	---	0.50	---	
$R_{\theta JA}$	Junction-to-Ambient, typical socket mount	---	---	80	
Wt	Weight	---	2 (0.07)	---	g (oz)

# IRG4BC30KDPbF

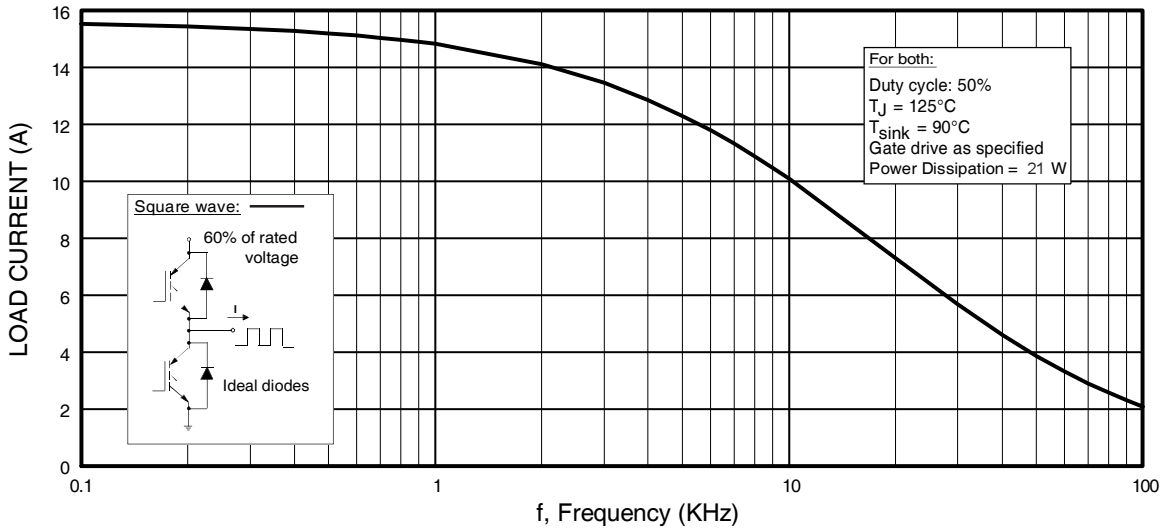
International  
IR Rectifier

## Electrical Characteristics @ T<sub>J</sub> = 25°C (unless otherwise specified)

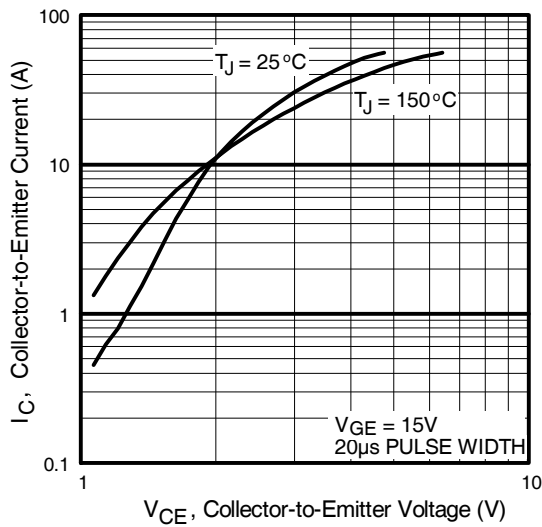
	Parameter	Min.	Typ.	Max.	Units	Conditions
V <sub>(BR)CES</sub>	Collector-to-Emitter Breakdown Voltage <sup>③</sup>	600	—	—	V	V <sub>GE</sub> = 0V, I <sub>C</sub> = 250μA
ΔV <sub>(BR)CES</sub> /ΔT <sub>J</sub>	Temperature Coeff. of Breakdown Voltage	—	0.54	—	V/°C	V <sub>GE</sub> = 0V, I <sub>C</sub> = 1.0mA
V <sub>CE(on)</sub>	Collector-to-Emitter Saturation Voltage	—	2.21	2.7	V	I <sub>C</sub> = 16A V <sub>GE</sub> = 15V
		—	2.88	—		I <sub>C</sub> = 28A See Fig. 2, 5
		—	2.36	—		I <sub>C</sub> = 16A, T <sub>J</sub> = 150°C
V <sub>GE(th)</sub>	Gate Threshold Voltage	3.0	—	6.0		V <sub>CE</sub> = V <sub>GE</sub> , I <sub>C</sub> = 250μA
ΔV <sub>GE(th)</sub> /ΔT <sub>J</sub>	Temperature Coeff. of Threshold Voltage	—	-12	—	mV/°C	V <sub>CE</sub> = V <sub>GE</sub> , I <sub>C</sub> = 250μA
g <sub>fe</sub>	Forward Transconductance <sup>④</sup>	5.4	8.1	—	S	V <sub>CE</sub> = 100V, I <sub>C</sub> = 16A
I <sub>CES</sub>	Zero Gate Voltage Collector Current	—	—	250	μA	V <sub>GE</sub> = 0V, V <sub>CE</sub> = 600V
		—	—	2500		V <sub>GE</sub> = 0V, V <sub>CE</sub> = 600V, T <sub>J</sub> = 150°C
V <sub>FM</sub>	Diode Forward Voltage Drop	—	1.4	1.7	V	I <sub>C</sub> = 12A See Fig. 13
		—	1.3	1.6		I <sub>C</sub> = 12A, T <sub>J</sub> = 150°C
I <sub>GES</sub>	Gate-to-Emitter Leakage Current	—	—	±100	nA	V <sub>GE</sub> = ±20V

## Switching Characteristics @ T<sub>J</sub> = 25°C (unless otherwise specified)

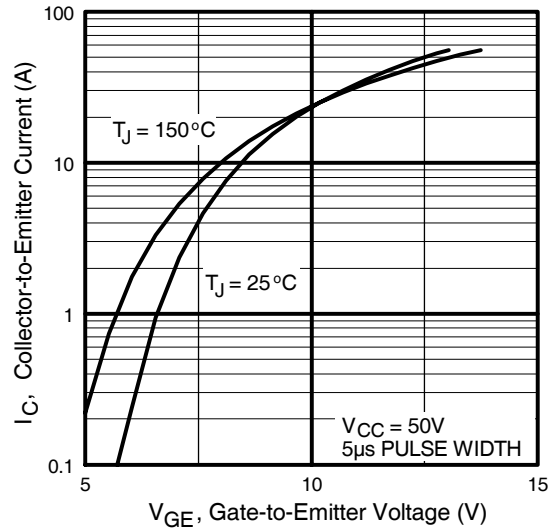
	Parameter	Min.	Typ.	Max.	Units	Conditions
Q <sub>g</sub>	Total Gate Charge (turn-on)	—	67	100	nC	I <sub>C</sub> = 16A V <sub>CC</sub> = 400V See Fig.8 V <sub>GE</sub> = 15V
Q <sub>ge</sub>	Gate - Emitter Charge (turn-on)	—	11	16		
Q <sub>gc</sub>	Gate - Collector Charge (turn-on)	—	25	37		
t <sub>d(on)</sub>	Turn-On Delay Time	—	60	—	ns	T <sub>J</sub> = 25°C I <sub>C</sub> = 16A, V <sub>CC</sub> = 480V V <sub>GE</sub> = 15V, R <sub>G</sub> = 23Ω
t <sub>r</sub>	Rise Time	—	42	—		
t <sub>d(off)</sub>	Turn-Off Delay Time	—	160	250		
t <sub>f</sub>	Fall Time	—	80	120		
E <sub>on</sub>	Turn-On Switching Loss	—	0.60	—	mJ	Energy losses include "tail" and diode reverse recovery See Fig. 9,10,14
E <sub>off</sub>	Turn-Off Switching Loss	—	0.58	—		
E <sub>ts</sub>	Total Switching Loss	—	1.18	1.6		
t <sub>sc</sub>	Short Circuit Withstand Time	10	—	—	μs	V <sub>CC</sub> = 360V, T <sub>J</sub> = 125°C V <sub>GE</sub> = 15V, R <sub>G</sub> = 10Ω, V <sub>CPK</sub> < 500V
t <sub>d(on)</sub>	Turn-On Delay Time	—	58	—	ns	T <sub>J</sub> = 150°C, See Fig. 11,14 I <sub>C</sub> = 16A, V <sub>CC</sub> = 480V V <sub>GE</sub> = 15V, R <sub>G</sub> = 23Ω
t <sub>r</sub>	Rise Time	—	42	—		
t <sub>d(off)</sub>	Turn-Off Delay Time	—	210	—		
t <sub>f</sub>	Fall Time	—	160	—		
E <sub>ts</sub>	Total Switching Loss	—	1.69	—	mJ	Energy losses include "tail" and diode reverse recovery
L <sub>E</sub>	Internal Emitter Inductance	—	7.5	—	nH	Measured 5mm from package
C <sub>ies</sub>	Input Capacitance	—	920	—	pF	V <sub>GE</sub> = 0V V <sub>CC</sub> = 30V See Fig. 7 f = 1.0MHz
C <sub>oes</sub>	Output Capacitance	—	110	—		
C <sub>res</sub>	Reverse Transfer Capacitance	—	27	—		
t <sub>rr</sub>	Diode Reverse Recovery Time	—	42	60	ns	T <sub>J</sub> = 25°C See Fig. 14
		—	80	120		T <sub>J</sub> = 125°C
I <sub>rr</sub>	Diode Peak Reverse Recovery Current	—	3.5	6.0	A	T <sub>J</sub> = 25°C See Fig. 15
		—	5.6	10		T <sub>J</sub> = 125°C
Q <sub>rr</sub>	Diode Reverse Recovery Charge	—	80	180	nC	T <sub>J</sub> = 25°C See Fig. 16
		—	220	600		T <sub>J</sub> = 125°C
di <sub>(rec)M</sub> /dt	Diode Peak Rate of Fall of Recovery During t <sub>b</sub>	—	180	—	A/μs	T <sub>J</sub> = 25°C See Fig. 17
		—	160	—		T <sub>J</sub> = 125°C



**Fig. 1 - Typical Load Current vs. Frequency**  
 (Load Current =  $I_{\text{RMS}}$  of fundamental)

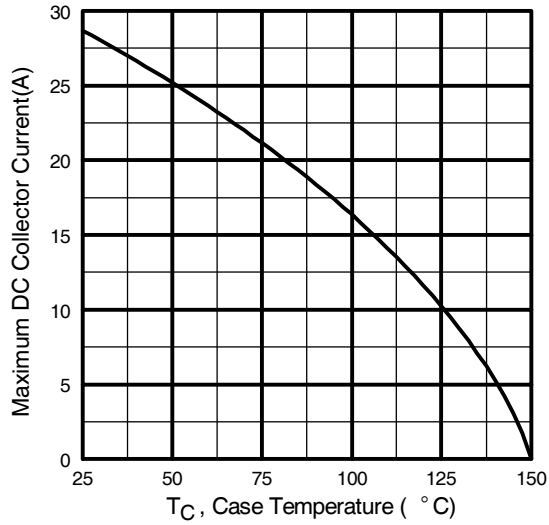


**Fig. 2 - Typical Output Characteristics**

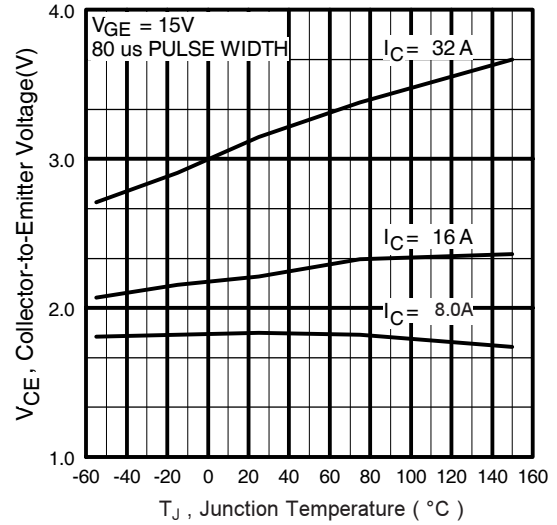


**Fig. 3 - Typical Transfer Characteristics**

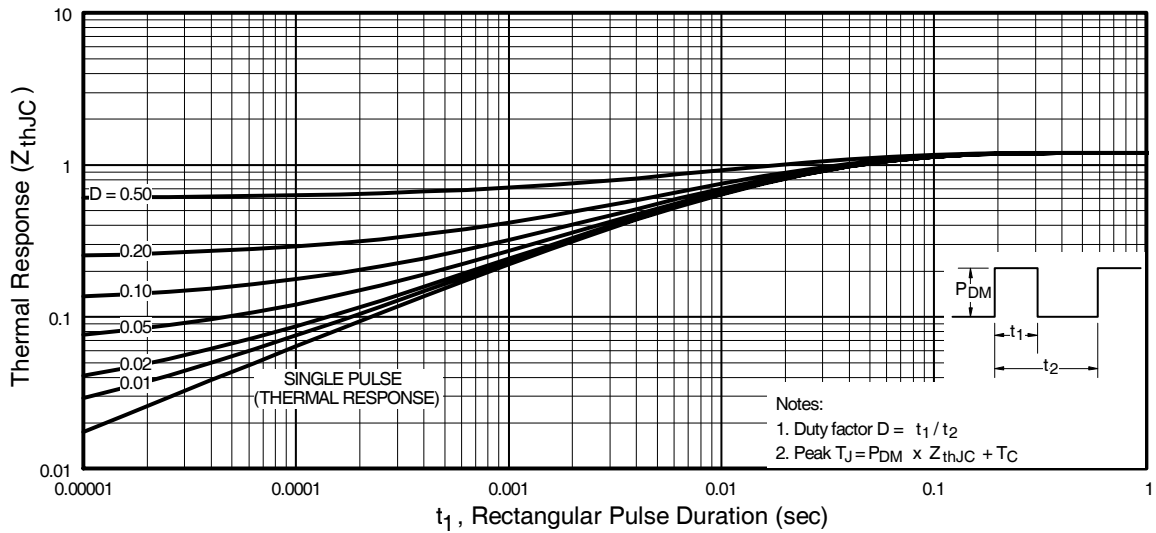
# IRG4BC30KDPbF



**Fig. 4 - Maximum Collector Current vs. Case Temperature**

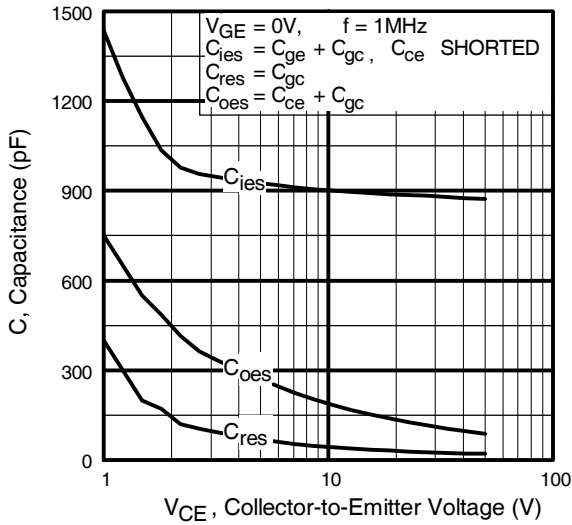


**Fig. 5 - Typical Collector-to-Emitter Voltage vs. Junction Temperature**

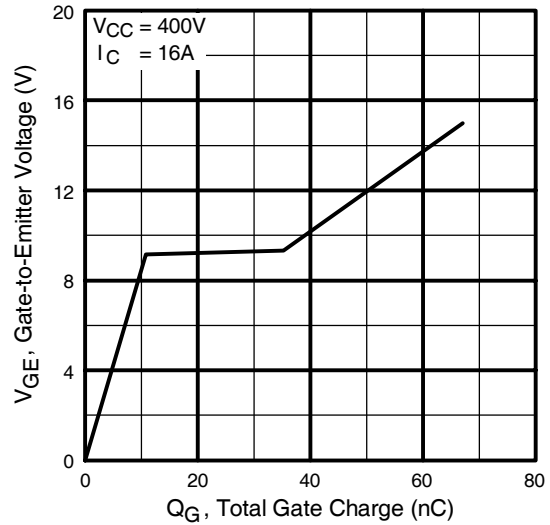


**Fig. 6 - Maximum Effective Transient Thermal Impedance, Junction-to-Case**

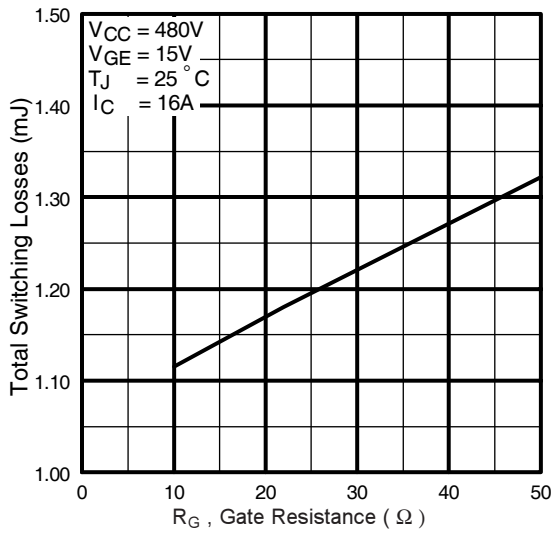
# IRG4BC30KDPbF



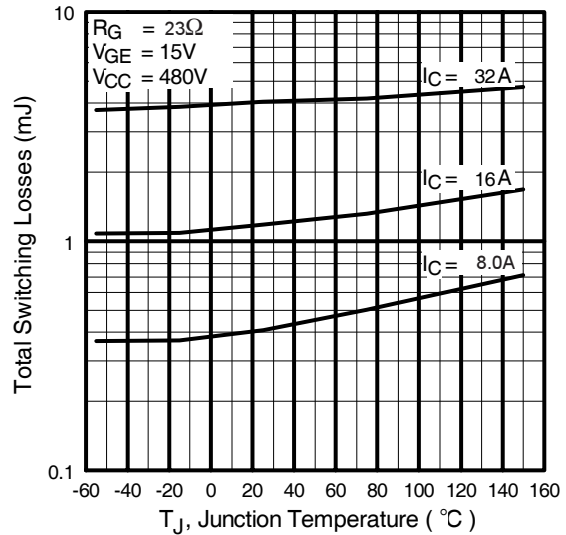
**Fig. 7** - Typical Capacitance vs. Collector-to-Emitter Voltage



**Fig. 8** - Typical Gate Charge vs. Gate-to-Emitter Voltage

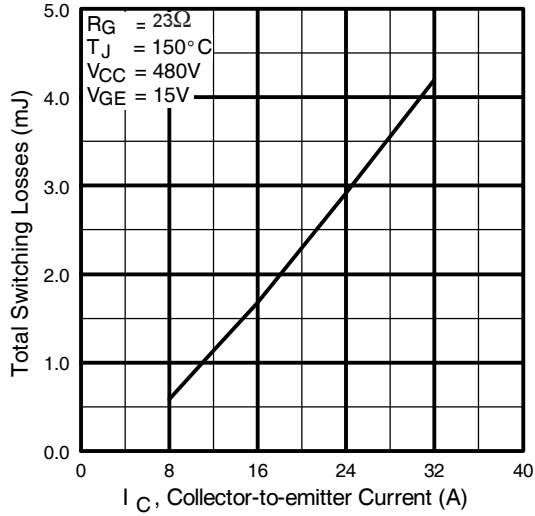


**Fig. 9** - Typical Switching Losses vs. Gate Resistance



**Fig. 10** - Typical Switching Losses vs. Junction Temperature

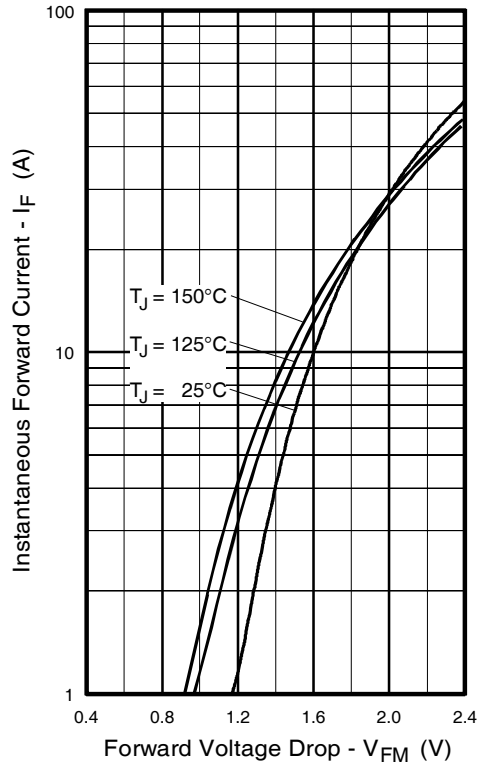
# IRG4BC30KDPbF



**Fig. 11** - Typical Switching Losses vs. Collector-to-Emitter Current



**Fig. 12** - Turn-Off SOA



**Fig. 13** - Maximum Forward Voltage Drop vs. Instantaneous Forward Current

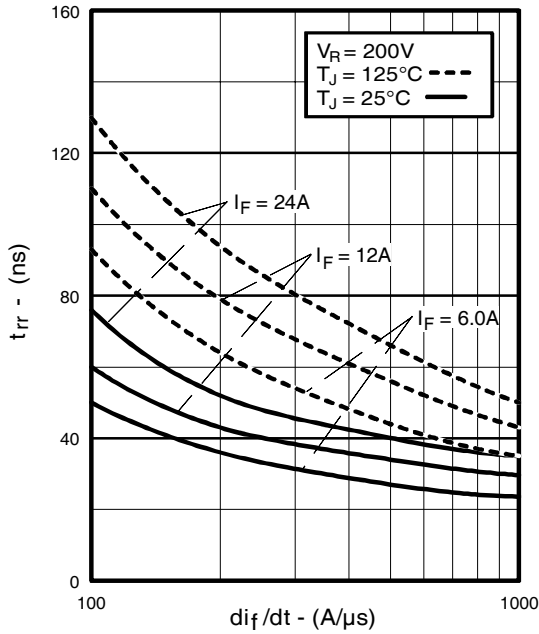


Fig. 14 - Typical Reverse Recovery vs.  $di_f/dt$

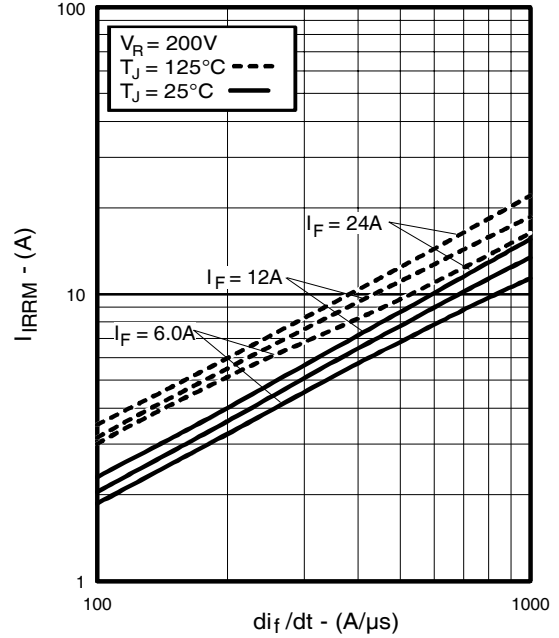


Fig. 15 - Typical Recovery Current vs.  $di_f/dt$

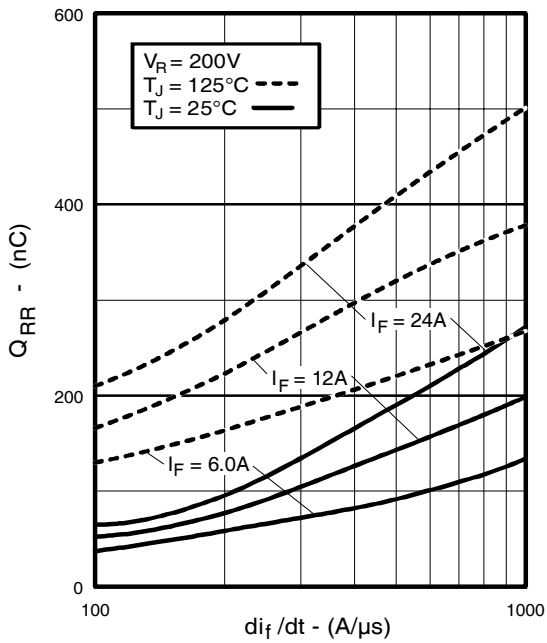


Fig. 16 - Typical Stored Charge vs.  $di_f/dt$

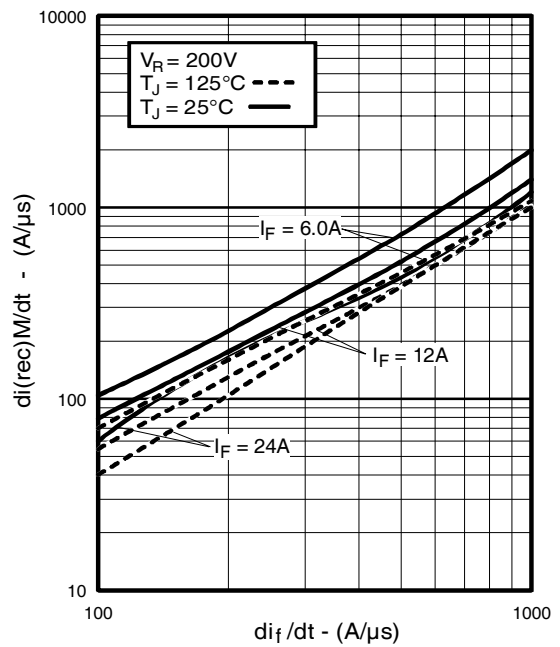
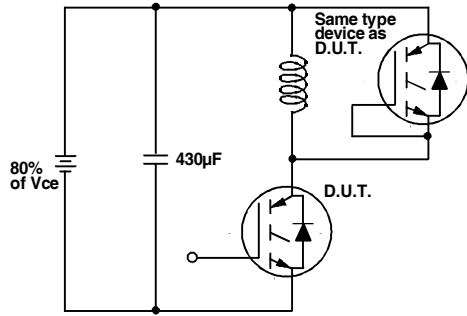
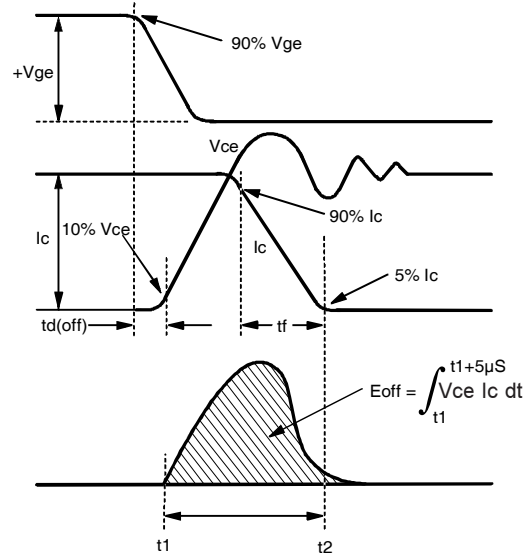


Fig. 17 - Typical  $di_{(rec)M}/dt$  vs.  $di_f/dt$

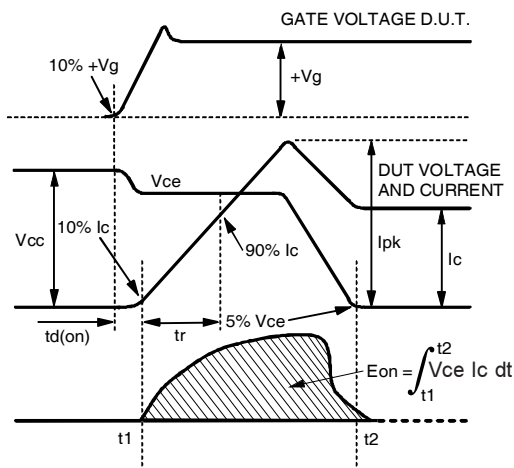
# IRG4BC30KDPbF



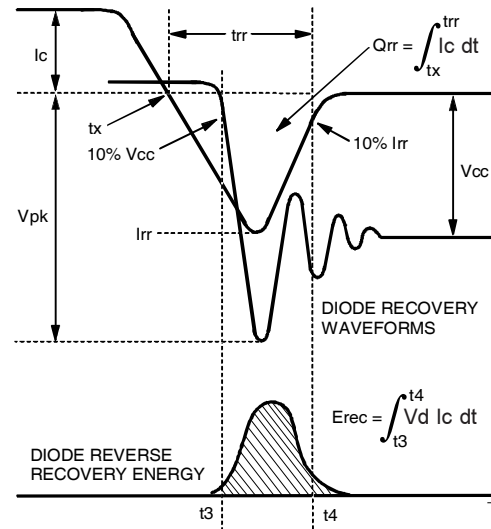
**Fig. 18a** - Test Circuit for Measurement of  $I_{LM}$ ,  $E_{on}$ ,  $E_{off}(\text{diode})$ ,  $t_{rr}$ ,  $Q_{rr}$ ,  $I_{rr}$ ,  $t_{d(on)}$ ,  $t_r$ ,  $t_{d(off)}$ ,  $t_f$



**Fig. 18b** - Test Waveforms for Circuit of Fig. 18a, Defining  $E_{off}$ ,  $t_{d(off)}$ ,  $t_f$



**Fig. 18c** - Test Waveforms for Circuit of Fig. 18a, Defining  $E_{on}$ ,  $t_{d(on)}$ ,  $t_r$



**Fig. 18d** - Test Waveforms for Circuit of Fig. 18a, Defining  $E_{rec}$ ,  $t_{rr}$ ,  $Q_{rr}$ ,  $I_{rr}$



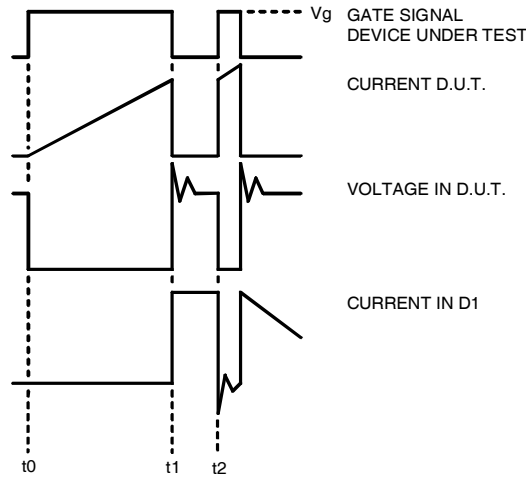


Figure 18e. Macro Waveforms for Figure 18a's Test Circuit

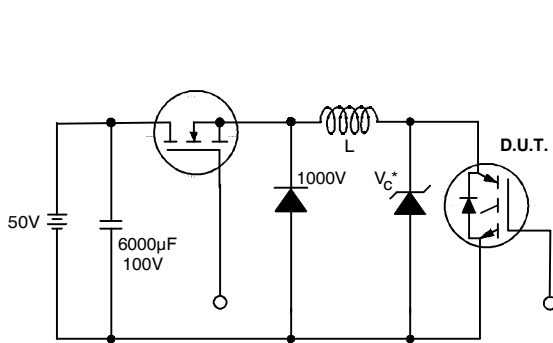


Figure 19. Clamped Inductive Load Test Circuit

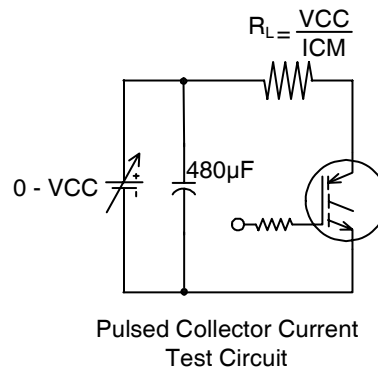


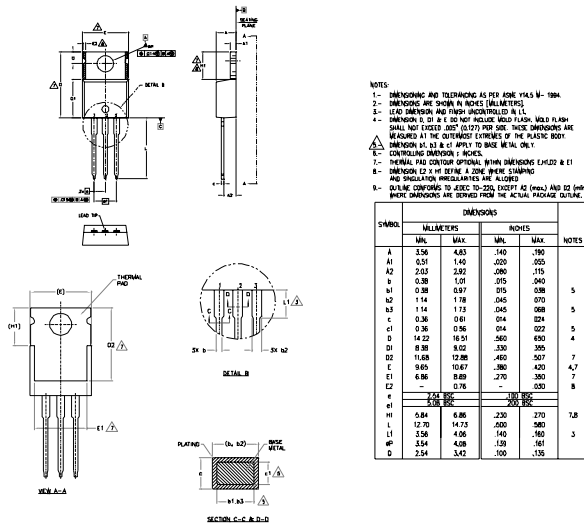
Figure 20. Pulsed Collector Current Test Circuit

# IRG4BC30KDPbF

## Notes:

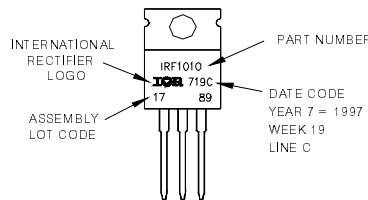
- ① Repetitive rating:  $V_{GE}=20V$ ; pulse width limited by maximum junction temperature (figure 20)
- ②  $V_{CC}=80\%(V_{CES})$ ,  $V_{GE}=20V$ ,  $L=10\mu H$ ,  $R_G=23\Omega$  (figure 19)
- ③ Pulse width  $\leq 80\mu s$ ; duty factor  $\leq 0.1\%$ .
- ④ Pulse width  $5.0\mu s$ , single shot.

## TO-220AB Package Outline (Dimensions are shown in millimeters (inches))



## TO-220AB Part Marking Information

EXAMPLE: THIS IS AN IRF1010  
 LOT CODE 1789  
 ASSEMBLED ON WW 19, 1997  
 IN THE ASSEMBLY LINE 'C'  
**Note:** "P" in assembly line position indicates "Lead-Free"



**Note:** For the most current drawing please refer to IR website at <http://www.irf.com/package/>

Data and specifications subject to change without notice.