



芯基科技

MPVX4N65F Series Power MOSFET

FEATURES

- BV_{DSS} : 650V, $I_D=4A$
- $R_{DS(on)}$: 2.8Ω(Max) @ $V_{GS}=10V$
- Very Low FOM ($R_{DS(on)} * Q_g$)
- Excellent stability and uniformity

APPLICATIONS

- Switch Mode Power Supply (SMPS)
- Uninterruptible Power Supply (UPS)
- Power Factor Correction (PFC)
- AC to DC Converters

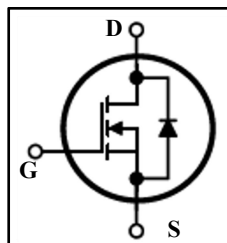
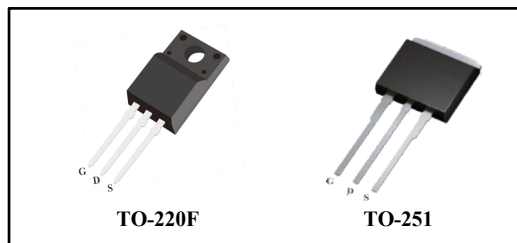

Ordering Information

Type NO.	Marking	Package Code
MPVA4N65F	MPVA4N65F	TO-220F
MPVU4N65F	MPVU4N65F	TO-251

Absolute Maximum Ratings $T_C = 25^\circ C$, unless otherwise noted

Parameter	Symbol	Value		Unit
		220F	251	
Drain-Source Voltage ($V_{GS} = 0V$)	V_{DSS}	650		V
Continuous Drain Current	I_D	4		A
Pulsed Drain Current (note1)	I_{DM}	16		A
Gate-Source Voltage	V_{GSS}	± 30		V
Single Pulse Avalanche Energy (note2)	E_{AS}	224		mJ
Avalanche Current (note1)	I_{AR}	4		A
Repetitive Avalanche Energy (note1)	E_{AR}	20		mJ
Power Dissipation ($T_C = 25^\circ C$)	P_D	36	80	W
Operating Junction and Storage Temperature Range	T_J, T_{stg}	-55~+150		$^\circ C$

Thermal Resistance

Parameter	Symbol	Value		Unit
		220F	251	
Thermal Resistance, Junction-to-Case	R_{thJC}	3.47	1.66	$^\circ C/W$
Thermal Resistance, Junction-to-Ambient	R_{thJA}	62.5	60.0	



芯基科技

MPVX4N65F Series Power MOSFET

Specifications $T_J = 25^\circ\text{C}$, unless otherwise noted						
Parameter	Symbol	Test Conditions	Value			Unit
			Min.	Typ.	Max.	
Static						
Drain-Source Breakdown Voltage	$V_{(BR)DSS}$	$V_{GS} = 0V, I_D = 250\mu A$	650	--	--	V
Zero Gate Voltage Drain Current	I_{DSS}	$V_{DS} = 650V, V_{GS} = 0V, T_J = 25^\circ\text{C}$	--	--	1	μA
Gate-Source Leakage	I_{GSS}	$V_{GS} = \pm 30V$	--	--	± 100	nA
Gate-Source Threshold Voltage	$V_{GS(th)}$	$V_{DS} = V_{GS}, I_D = 250\mu A$	2.0	--	4.0	V
Drain-Source On-Resistance (Note4)	$R_{DS(on)}$	$V_{GS} = 10V, I_D = 2.0A$	--	2.3	2.8	Ω
Dynamic						
Input Capacitance	C_{iss}	$V_{GS} = 0V,$ $V_{DS} = 25V,$ $f = 1.0\text{MHz}$	--	530	--	pF
Output Capacitance	C_{oss}		--	48	--	
Reverse Transfer Capacitance	C_{rss}		--	6	--	
Total Gate Charge	Q_g	$V_{DD} = 400V, I_D = 4.0A,$ $V_{GS} = 10V$	--	11	--	nC
Gate-Source Charge	Q_{gs}		--	3	--	
Gate-Drain Charge	Q_{gd}		--	4	--	
Turn-on Delay Time	$t_{d(on)}$	$V_{DD} = 325V, I_D = 4.0A,$ $R_G = 25\Omega$	--	20	--	ns
Turn-on Rise Time	t_r		--	55	--	
Turn-off Delay Time	$t_{d(off)}$		--	70	--	
Turn-off Fall Time	t_f		--	50	--	
Drain-Source Body Diode Characteristics						
Continuous Body Diode Current	I_S	$T_C = 25^\circ\text{C}$	--	--	4	A
Pulsed Diode Forward Current	I_{SM}		--	--	16	
Body Diode Voltage	V_{SD}	$T_J = 25^\circ\text{C}, I_{SD} = 4.0A, V_{GS} = 0V$	--	--	1.5	V
Reverse Recovery Time	t_{rr}	$V_R = 400V, I_F = 4.0A,$ $di_F/dt = 100A/\mu s$	--	390	--	ns
Reverse Recovery Charge	Q_{rr}		--	2.2	--	μC

Notes

1. Repetitive Rating: Pulse width limited by maximum junction temperature
2. $L = 10\text{mH}, V_{DD} = 50V, R_G = 25\Omega, \text{Starting } T_J = 25^\circ\text{C}$
3. Pulse Test: Pulse width $\leq 300\mu s$, Duty Cycle $\leq 1\%$
4. Essentially independent of operating temperature

Typical Characteristics $T_j = 25^\circ\text{C}$, unless otherwise noted

Figure 1. Output Characteristics

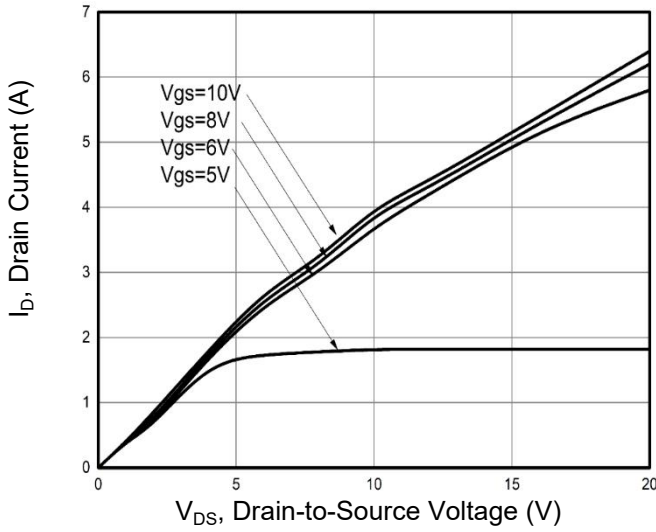

Figure 2. Transfer Characteristics

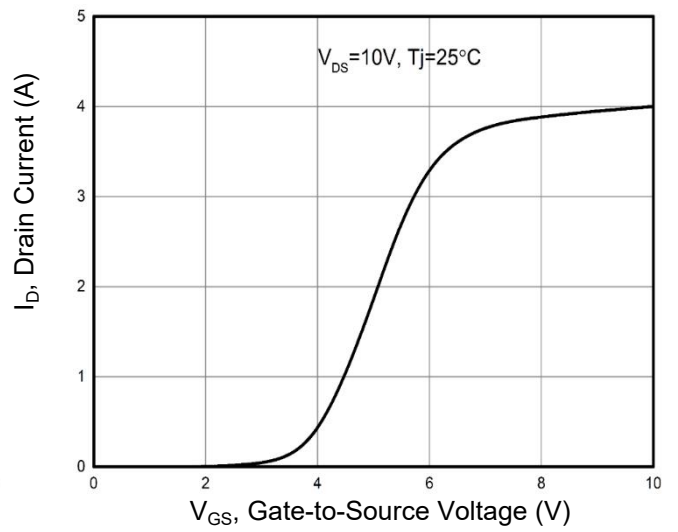

Figure 3. Drain Current vs. Temperature

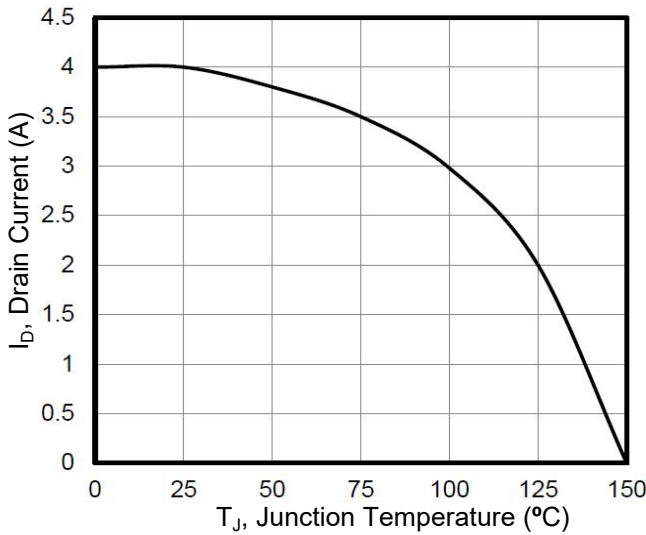

Figure 4. Capacitance

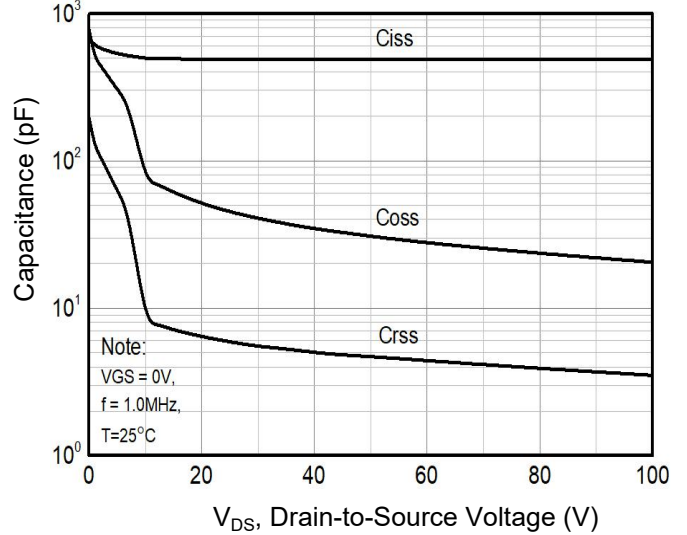

Figure 5. Gate Charge

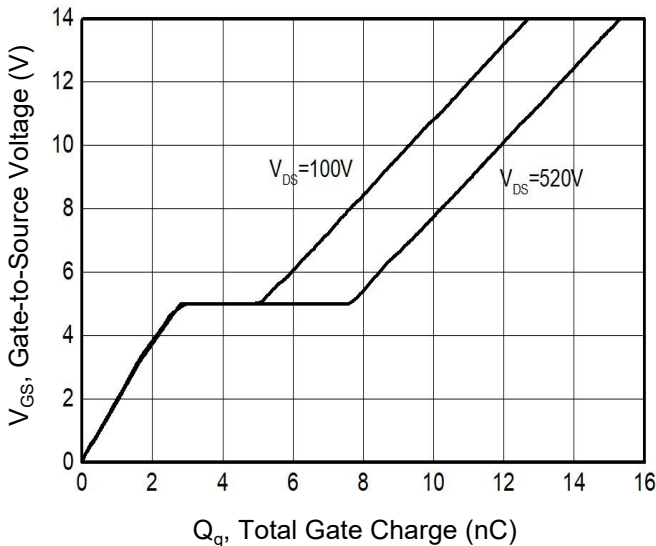
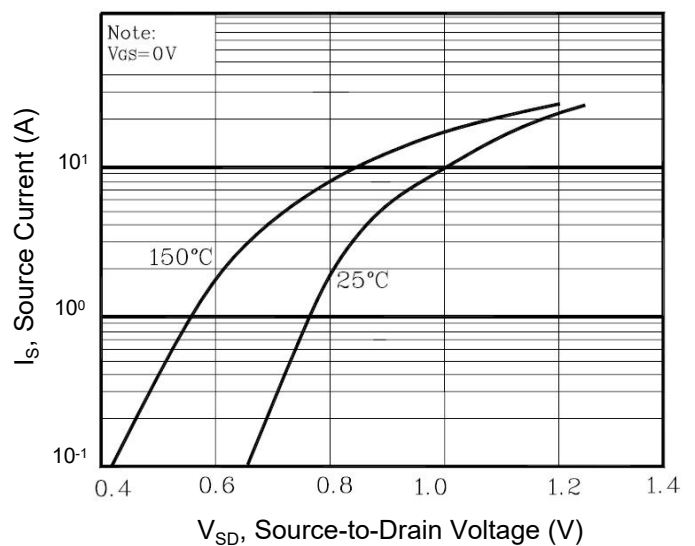

Figure 6. Body Diode Forward Voltage



Typical Characteristics $T_J = 25^\circ\text{C}$, unless otherwise noted

Figure 7. On-Resistance vs. Temperature

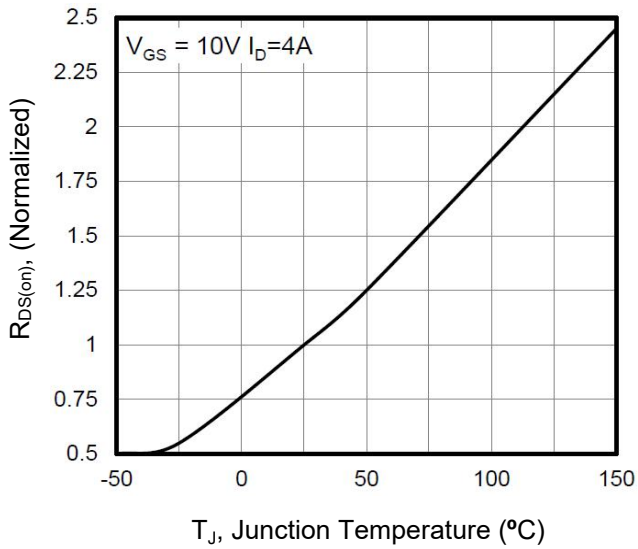
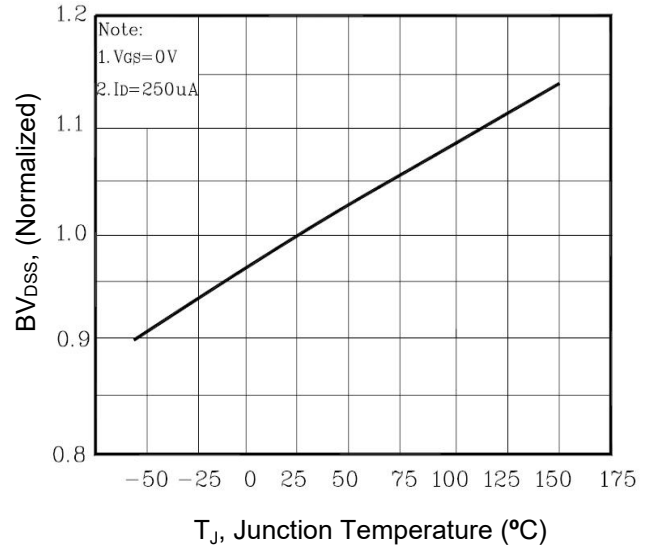
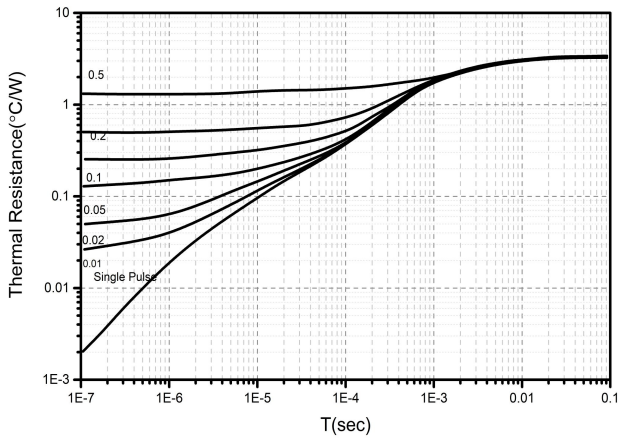

Figure 8. BV_{DSS} vs. Temperature



**Figure 9. Transient Thermal Impedance
(TO-220F)**



**Figure 10. Transient Thermal Impedance
(TO-251)**

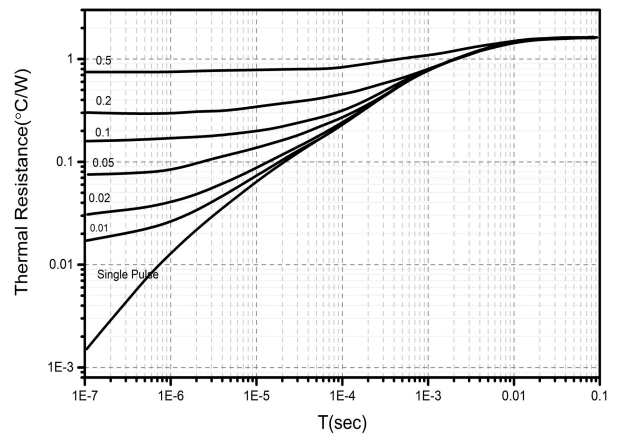

Figure A: Gate Charge Test Circuit and Waveform

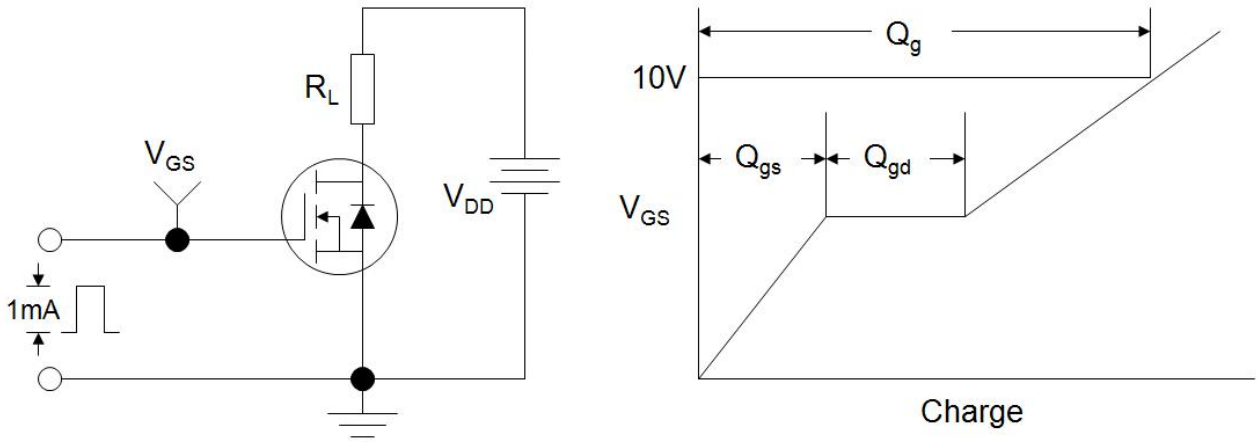

Figure B: Resistive Switching Test Circuit and Waveform

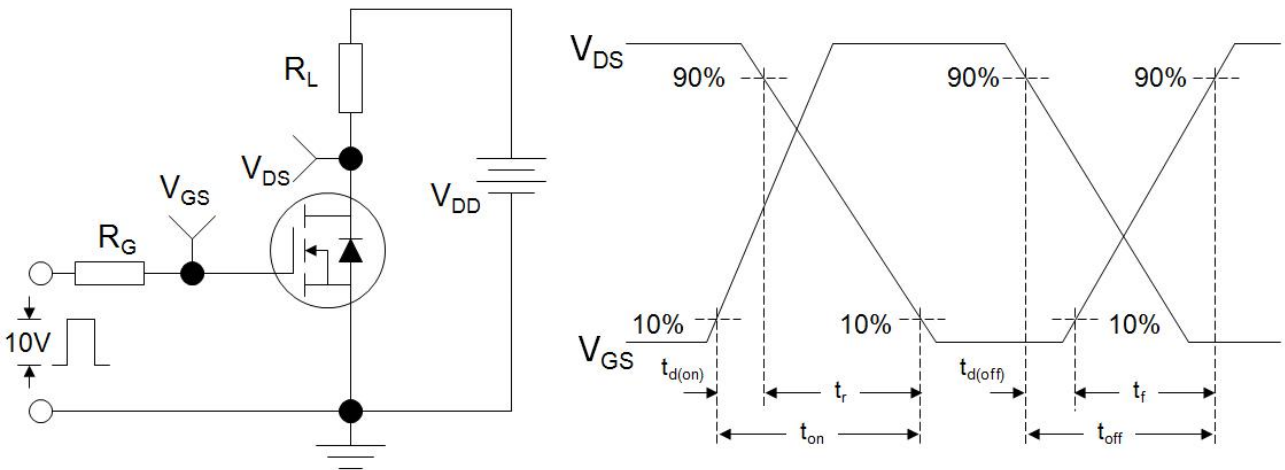
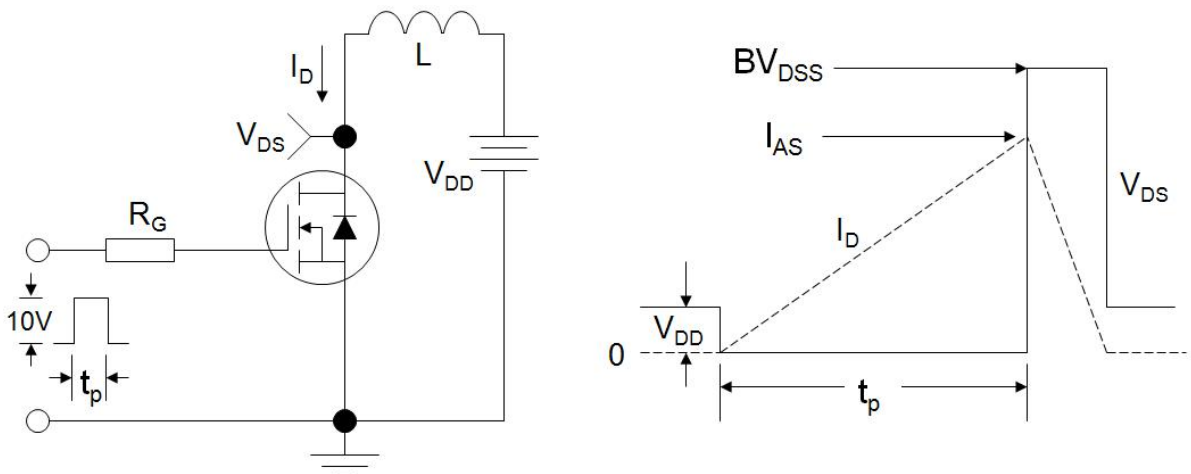

Figure C: Unclamped Inductive Switching Test Circuit and Waveform



Outline Dimension

Unit: mm

TO-220F

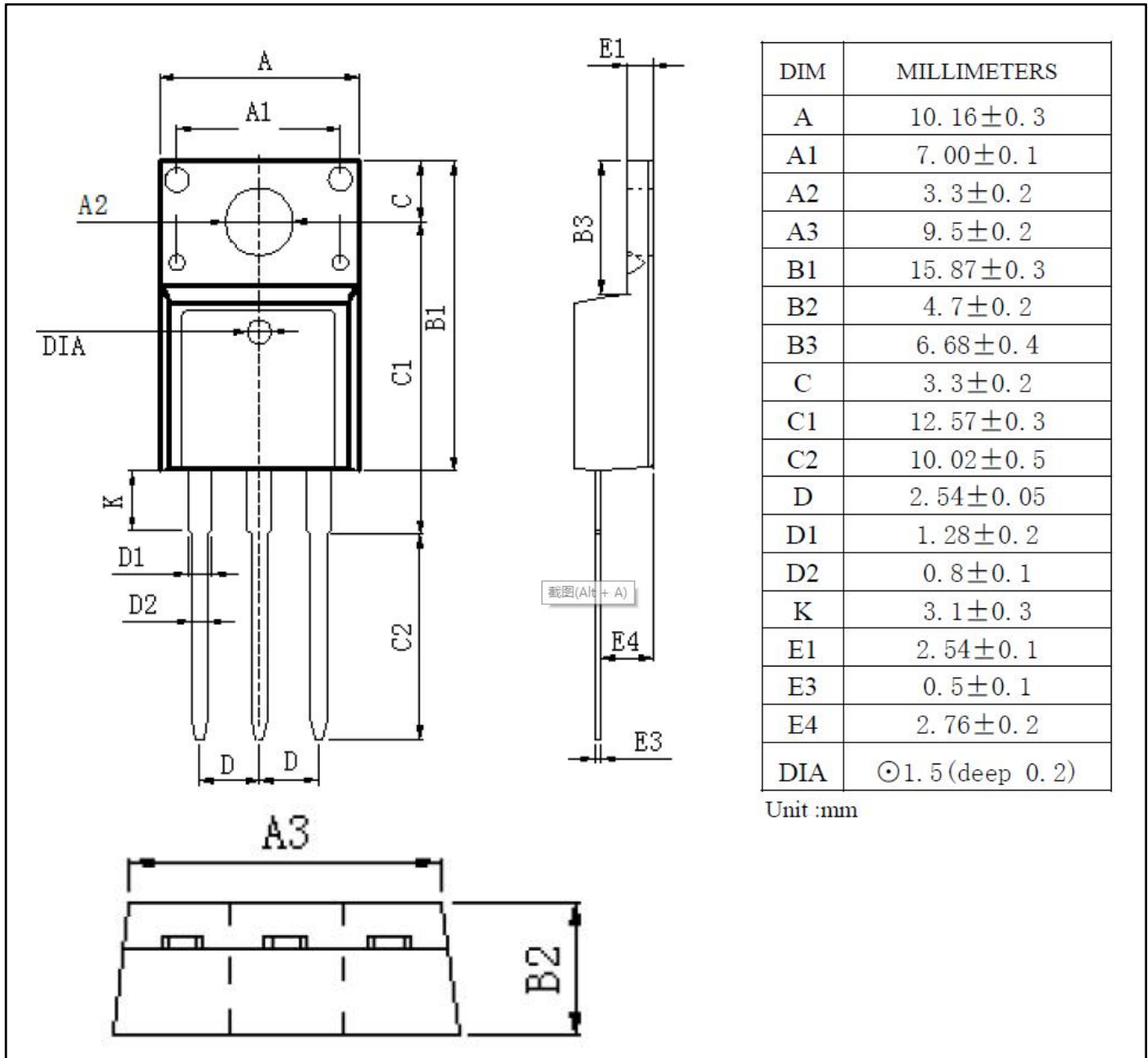

Outline Dimension

Unit: mm

TO-251

