

### DESCRIPTION

The MP1605 is a monolithic, step-down, switch-mode converter with built-in, internal power MOSFETs. It achieves 2A of output current from a 2.3V to 5.5V input voltage with excellent load and line regulation. The output voltage can be regulated as low as 0.6V.

The constant-on-time control scheme provides a fast transient response and eases loop stabilization. Full protection features include cycle-by-cycle current limiting and thermal shutdown.

The MP1605 is available in an ultra-small SOT563 package and requires a minimal number of readily available, standard, external components.

The MP1605 is ideal for a wide range of applications, including high-performance DSPs, wireless power, portable and mobile devices, and other low-power systems.

### FEATURES

- Low  $I_Q$ : 11 $\mu$ A
- 2.2MHz Switching Frequency
- EN for Power Sequencing
- Wide 2.3V to 5.5V Operating Input Range
- Output Adjustable from 0.6V
- Up to 2A Output Current
- 120m $\Omega$  and 80m $\Omega$  Internal Power MOSFET Switches
- Output Discharge
- Short-Circuit Protection (SCP) with Hiccup Mode
- Stable with Low ESR Output Ceramic Capacitors
- Available in a SOT563 Package
- 100% Duty Cycle

### APPLICATIONS

- Wireless/Networking Cards
- Portable and Mobile Devices
- Battery-Powered Devices
- Low-Voltage I/O System Power
- Solid-State Drives (SSDs)

All MPS parts are lead-free, halogen-free, and adhere to the RoHS directive. For MPS green status, please visit the MPS website under Quality Assurance. "MPS" and "The Future of Analog IC Technology" are registered trademarks of Monolithic Power Systems, Inc.

### TYPICAL APPLICATION

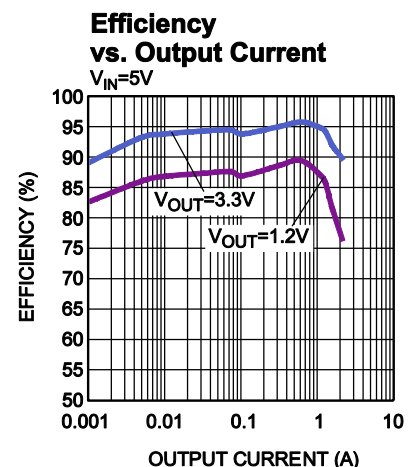
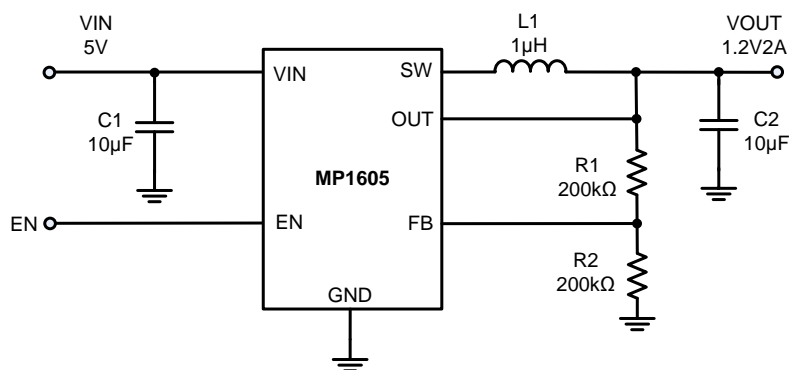

**ORDERING INFORMATION**

Part Number*	Package	Top Marking
MP1605GTF	SOT563	See Below

\* For Tape & Reel, add suffix -Z (e.g. MP1605GTF-Z)

**TOP MARKING****AUEY****LLL**

AUE: Product code of MP1605GTF

Y: Year code

LLL: Lot number

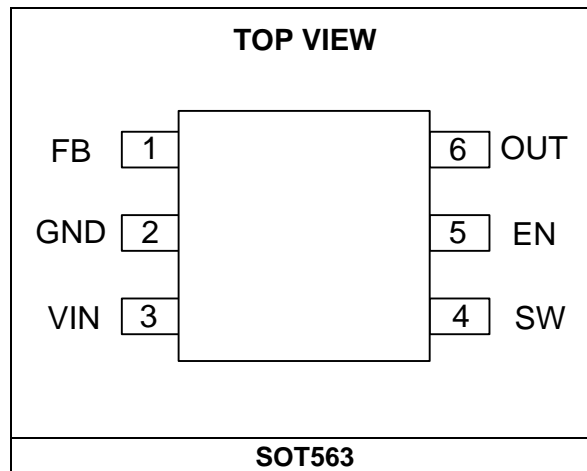
**PACKAGE REFERENCE**

**ABSOLUTE MAXIMUM RATINGS** <sup>(1)</sup>

Supply voltage ( $V_{IN}$ ) .....	6V
$V_{SW}$ .....	-0.3V (-5V for <20ns) to 6V (8V for <20ns or 10V for <10ns)
All other pins .....	-0.3V to 6V
Junction temperature .....	150°C
Lead temperature .....	260°C
Continuous power dissipation ( $T_A = +25^\circ\text{C}$ ) <sup>(2)</sup>	.....1W
Storage temperature .....	-65°C to +150°C

**Recommended Operating Conditions** <sup>(3)</sup>

Supply voltage ( $V_{IN}$ ) .....	2.3V to 5.5V
Operating junction temp. ( $T_J$ ) ..	-40°C to +125°C

<b>Thermal Resistance</b> <sup>(4)</sup>	$\theta_{JA}$	$\theta_{JC}$	
SOT563.....	130.....	60 ...	°C/W

**NOTES:**

- 1) Exceeding these ratings may damage the device.
- 2) The maximum allowable power dissipation is a function of the maximum junction temperature  $T_J$  (MAX), the junction-to-ambient thermal resistance  $\theta_{JA}$ , and the ambient temperature  $T_A$ . The maximum allowable continuous power dissipation at any ambient temperature is calculated by  $P_D$  (MAX) =  $(T_J$  (MAX)- $T_A$ )/ $\theta_{JA}$ . Exceeding the maximum allowable power dissipation produces an excessive die temperature, causing the regulator to go into thermal shutdown. Internal thermal shutdown circuitry protects the device from permanent damage.
- 3) The device is not guaranteed to function outside of its operating conditions.
- 4) Measured on JESD51-7, 4-layer PCB.

## ELECTRICAL CHARACTERISTICS

$V_{IN} = 3.6V$ ,  $T_J = -40^{\circ}C$  to  $+125^{\circ}C$ , typical value is tested at  $T_J = +25^{\circ}C$ . The limit over temperature is guaranteed by characterization, unless otherwise noted.

Parameter	Symbol	Condition	Min	Typ	Max	Units
Feedback voltage	$V_{FB}$	$2.3V \leq V_{IN} \leq 5.5V$ , $T_J = 25^{\circ}C$	594	600	606	mV
		$T_J = -40^{\circ}C$ to $+125^{\circ}C$	588		612	
Feedback current	$I_{FB}$	$V_{FB} = 0.63V$		50	100	nA
P-FET switch on resistance	$R_{DSON\_P}$			120		mΩ
N-FET switch on resistance	$R_{DSON\_N}$			80		mΩ
Switch leakage current		$V_{EN} = 0V$ , $V_{IN} = 6V$ , $V_{SW} = 0V$ and $6V$ , $T_J = 25^{\circ}C$		0	1	µA
P-FET peak current limit		Sourcing	2.4			A
N-FET valley current limit		Sourcing, valley current limit		1.6		A
ZCD				0		mA
On time	$T_{ON}$	$V_{IN} = 5V$ , $V_{OUT} = 1.2V$		110		ns
		$V_{IN} = 3.6V$ , $V_{OUT} = 1.2V$		150		
Switching frequency	$f_s$	$V_{IN} = 5V$ , $V_{OUT} = 1.2V$ , $I_{OUT} = 500mA$ , $T_J = 25^{\circ}C^{(5)}$	1760	2200	2640	kHz
		$V_{IN} = 5V$ , $V_{OUT} = 1.2V$ , $I_{OUT} = 500mA$ , $T_J = -40^{\circ}C$ to $+125^{\circ}C^{(5)}$	1650	2200	2750	kHz
Minimum off time	$T_{MIN-OFF}$			60		ns
Minimum on time <sup>(5)</sup>	$T_{MIN-ON}$			60		ns
Soft-start time	$T_{SS-ON}$	$V_{OUT}$ rise from 10% to 90%		0.5		ms
Under-voltage lockout threshold rising				2	2.25	V
Under-voltage lockout threshold hysteresis				150		mV
EN input logic low voltage					0.4	V
EN input logic high voltage			1.2			V
Output discharge resistor	$R_{DIS}$	$V_{EN} = 0V$ , $V_{OUT} = 1.2V$		1		kΩ
EN input current		$V_{EN} = 2V$		1.2		µA
		$V_{EN} = 0V$		0		µA
Supply current (shutdown)		$V_{EN} = 0V$ , $T_J = 25^{\circ}C$		0	1	µA
Supply current (quiescent)		$V_{EN} = 2V$ , $V_{FB} = 0.63V$ , $V_{IN} = 3.6V$ , $5V$ , $T_J = 25^{\circ}C$		11	13	µA
Thermal shutdown <sup>(6)</sup>				160		°C
Thermal hysteresis <sup>(6)</sup>				30		°C

**NOTES:**

5) Guaranteed by characterization.

6) Guaranteed by design.

## TYPICAL PERFORMANCE CHARACTERISTICS

$V_{IN} = 5V$ ,  $V_{OUT} = 1.2V$ ,  $L = 1.0\mu H$ ,  $T_A = +25^\circ C$ , unless otherwise noted.

**Quiescent Current vs. Input Voltage**

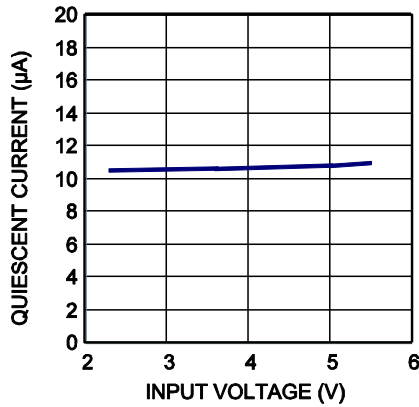

**Shutdown Current vs. Input Voltage**

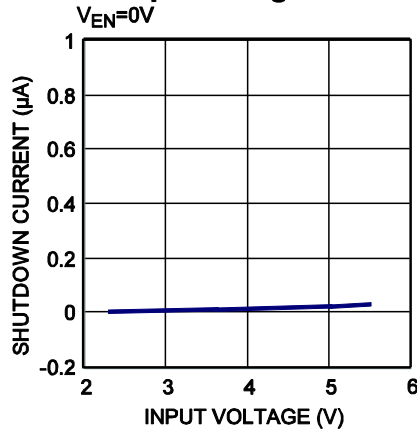

**Load Regulation vs. Output Current**

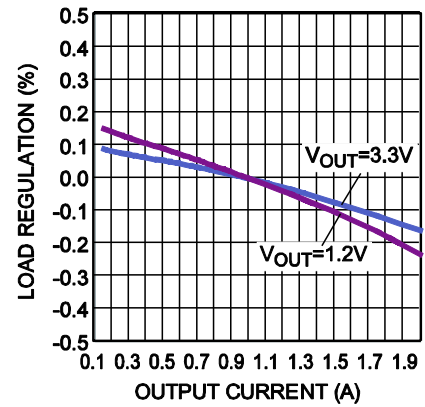

**Line Regulation vs. Input Voltage**

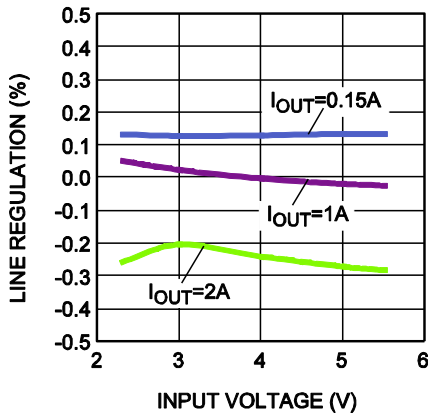

**Case Temperature Rise vs. Output Current**

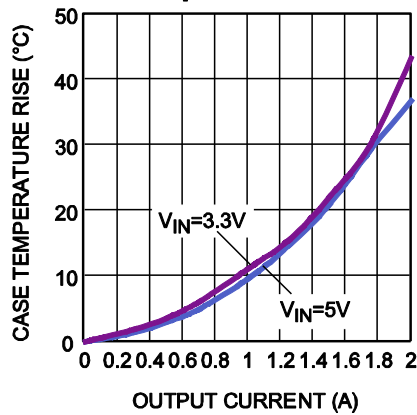

**Efficiency vs. Output Current**

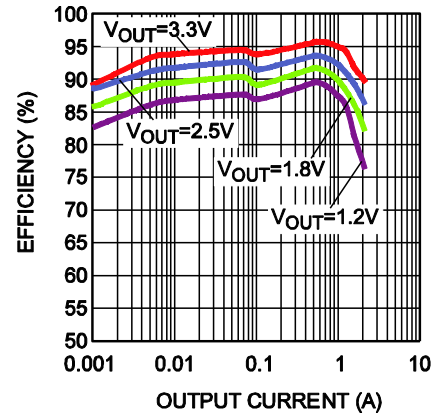

**Efficiency vs. Output Current**

$V_{IN}=3.3V$

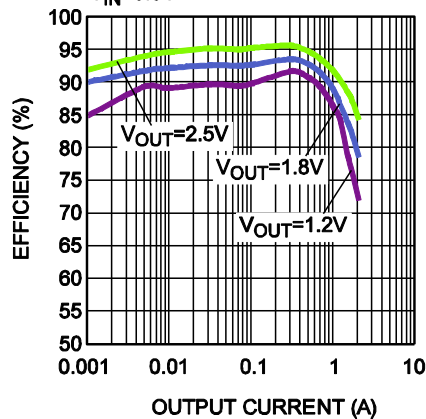

**TYPICAL PERFORMANCE CHARACTERISTICS (continued)**
 $V_{IN} = 5V$ ,  $V_{OUT} = 1.2V$ ,  $L = 1.0\mu H$ ,  $T_A = +25^\circ C$ , unless otherwise noted.

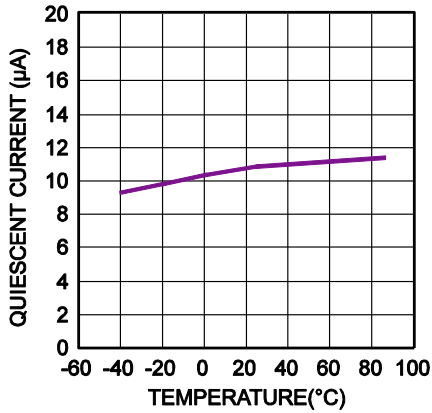
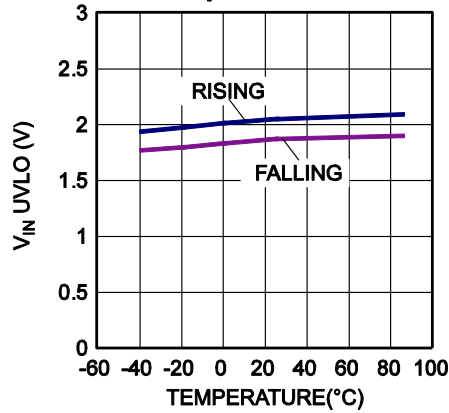
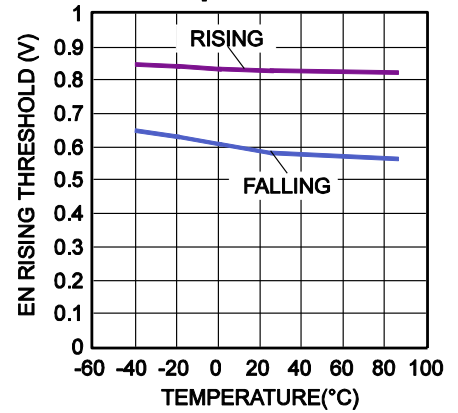
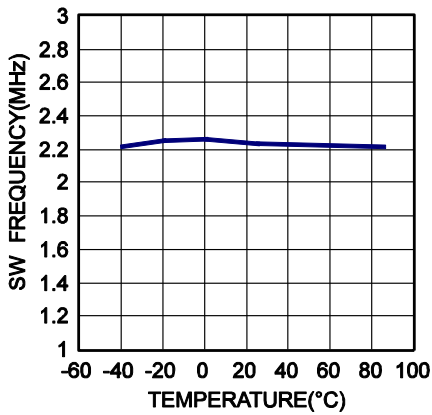
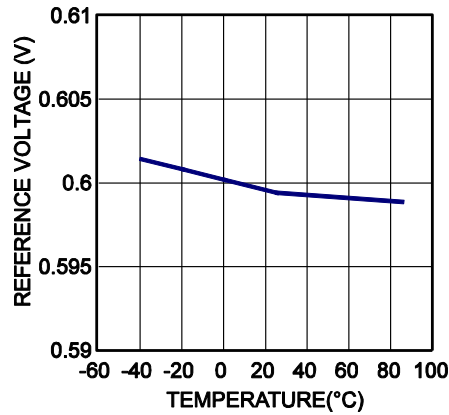
**Quiescent Current vs. Temperature**

 **$V_{IN}$  UVLO Rising and Falling Threshold vs. Temperature**

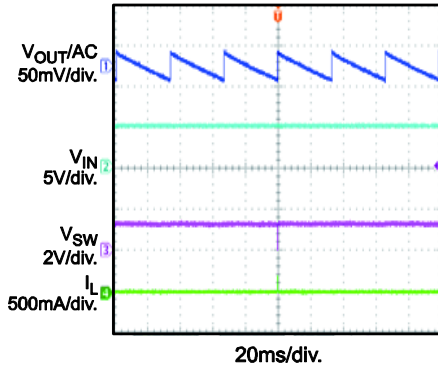
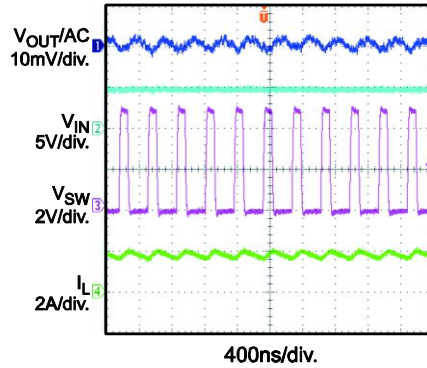
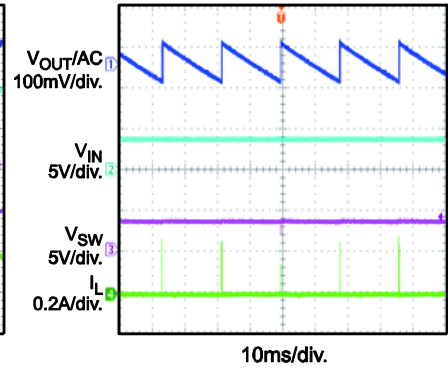
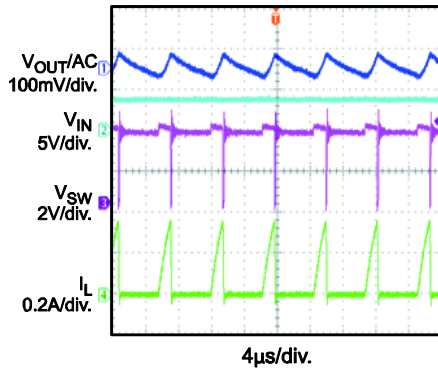
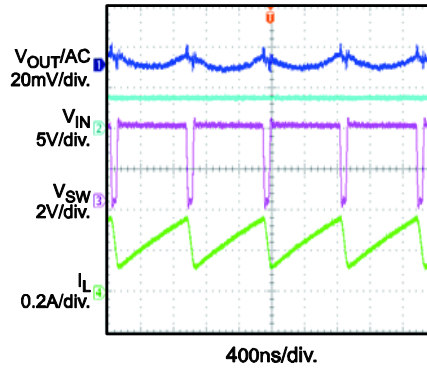
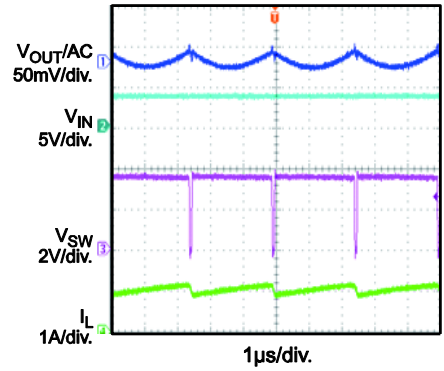
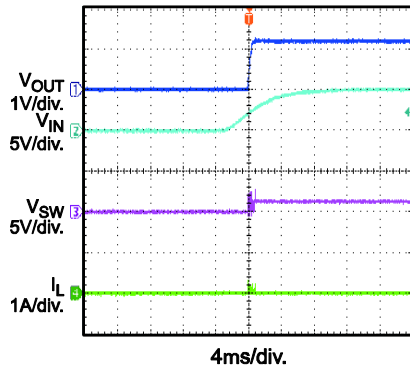
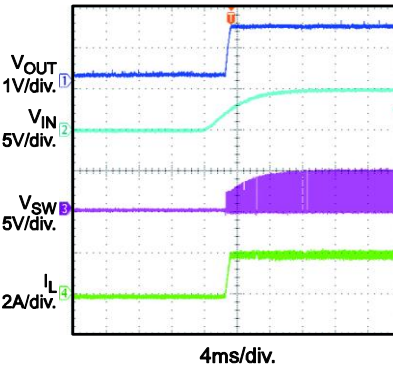
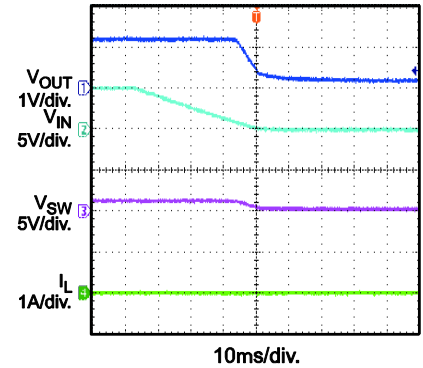
**EN Rising and Falling Threshold vs. Temperature**

**Switch Frequency vs. Temperature**

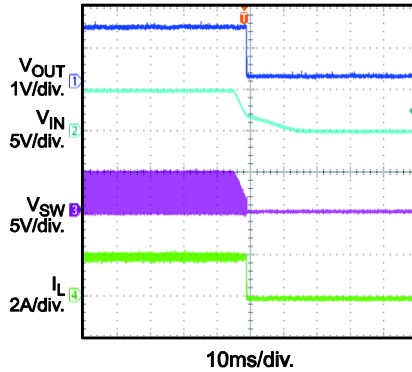
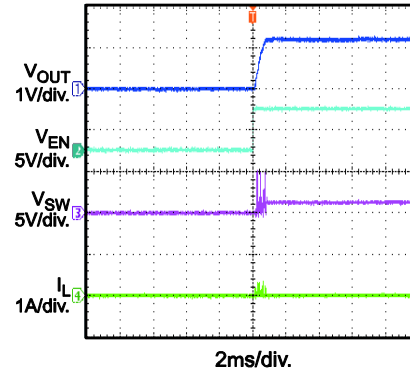
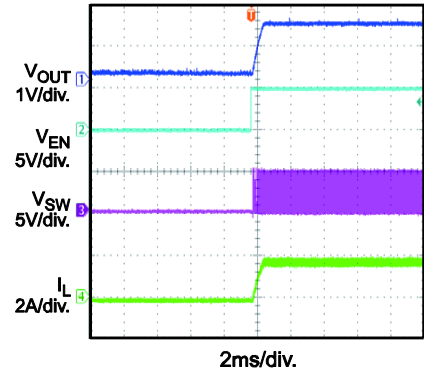
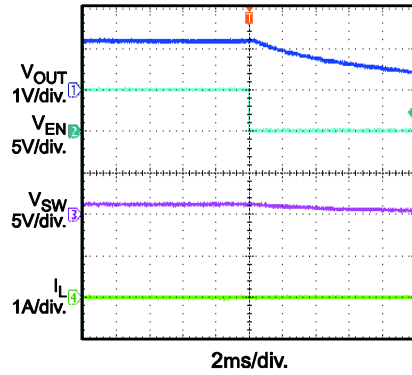
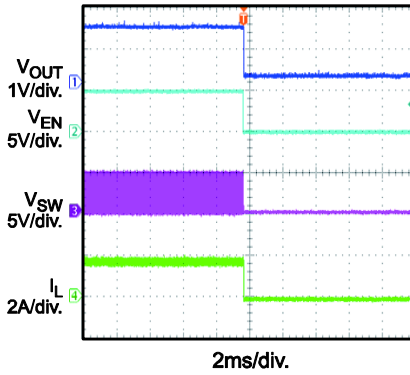
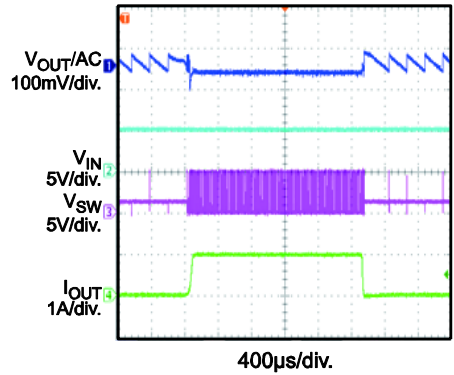
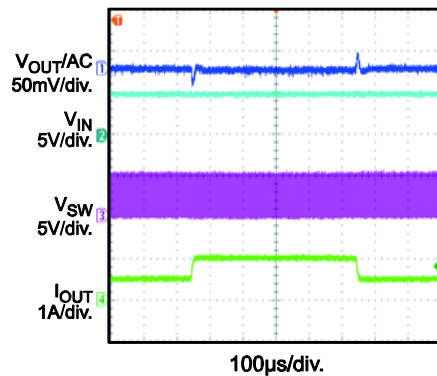
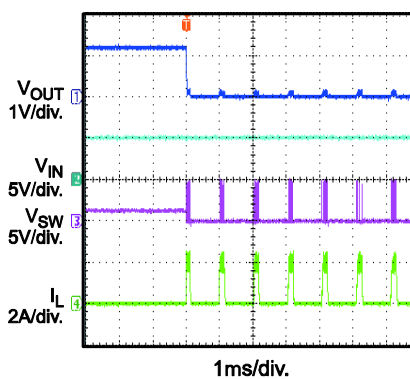
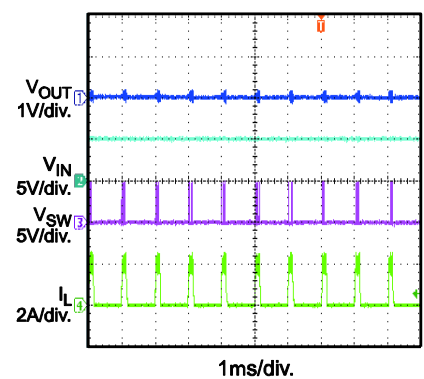
**Reference Voltage vs. Temperature**
 $V_{IN} = 3.6V$ 

**TYPICAL PERFORMANCE CHARACTERISTICS (continued)**
 $V_{IN} = 5V$ ,  $V_{OUT} = 1.2V$ ,  $L = 1.0\mu H$ ,  $T_A = +25^\circ C$ , unless otherwise noted.

**Steady State**  
without Load

**Steady State**  
with 2A Load

**Steady State**  
 $V_{IN}=3.6V$ ,  $V_{OUT}=3.3V$ ,  $I_{OUT}=0A$ 

**Steady State**
 $V_{IN}=3.6V$ ,  $V_{OUT}=3.3V$ ,  $I_{OUT}=0.05A$ , AAM

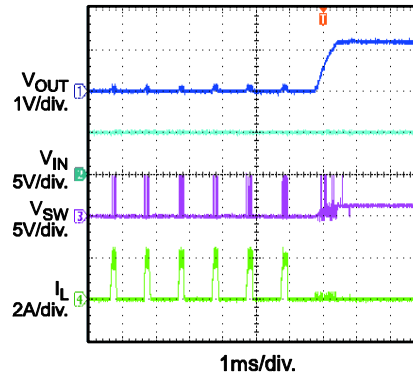
**Steady State**
 $V_{IN}=3.6V$ ,  $V_{OUT}=3.3V$ ,  $I_{OUT}=0.25A$ , AAM

**Steady State**
 $V_{IN}=3.6V$ ,  $V_{OUT}=3.3V$ ,  $I_{OUT}=1A$ , AAM

**VIN Power Up**  
without Load

**VIN Power Up**  
with 2A Load

**VIN Shut Down**  
without Load

**TYPICAL PERFORMANCE CHARACTERISTICS (continued)**
 $V_{IN} = 5V$ ,  $V_{OUT} = 1.2V$ ,  $L = 1.0\mu H$ ,  $T_A = +25^\circ C$ , unless otherwise noted.

 **$V_{IN}$  Shut Down**  
with 2A Load

**EN Start Up**  
without Load

**EN Start Up**  
with 2A Load

**EN Shut Down**  
without Load

**EN Shut Down**  
with 2A Load

**Load Transient Response**  
 $I_{OUT} = 0A$  to  $1A$ 

**Load Transient Response**  
 $I_{OUT} = 0.5A$  to  $1A$ 

**Short Circuit Entry**

**Short Circuit**



**TYPICAL PERFORMANCE CHARACTERISTICS** (continued) $V_{IN} = 5V$ ,  $V_{OUT} = 1.2V$ ,  $L = 1.0\mu H$ ,  $T_A = +25^\circ C$ , unless otherwise noted.**Short Circuit Recovery**

**PIN FUNCTIONS**

Pin #	Name	Description
1	FB	<b>Feedback.</b> An external resistor divider from the output to GND tapped to FB sets the output voltage.
2	GND	<b>Power ground.</b>
3	VIN	<b>Supply voltage.</b> The MP1605 operates from a 2.3V to 5.5V unregulated input. A decoupling capacitor is required to prevent large voltage spikes from appearing at the input.
4	SW	<b>Output switching node.</b> SW is the drain of the internal high-side P-channel MOSFET. Connect the inductor to SW to complete the converter.
5	EN	<b>On/off control.</b>
6	OUT	<b>Output voltage power rail and input sense for the output voltage.</b> Connect the load to OUT. An output capacitor is required to decrease the output voltage ripple.

### BLOCK DIAGRAM

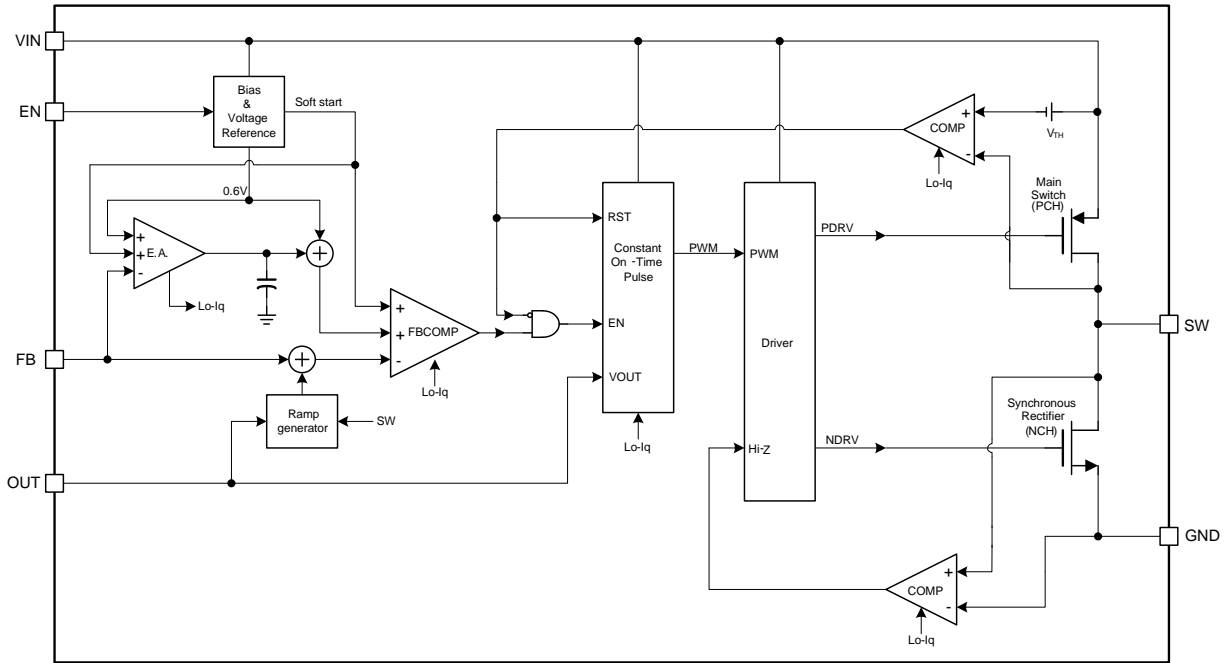

Figure 1: Functional Block Diagram

## OPERATION

The MP1605 uses constant on-time control with input voltage feed-forward to stabilize the switching frequency over the full input range. It achieves 2A of output current from a 2.3V to 5.5V input voltage range with excellent load and line regulation. The output voltage can be regulated as low as 0.6V.

### Constant-On-Time Control

Compared to fixed frequency PWM control, constant-on-time control offers a simpler control loop and faster transient response. By using input voltage feed-forward, the MP1605 maintains a nearly constant switching frequency across the input and output voltage ranges. The switching pulse on time can be estimated with Equation (1):

$$T_{ON} = \frac{V_{OUT}}{V_{IN}} \cdot 0.454\mu s \quad (1)$$

To prevent inductor current runaway during the load transient, the MP1605 has a fixed minimum off time of 60ns.

### Sleep Mode Operation

The MP1605 features sleep mode to achieve high efficiency at extreme light-load. In sleep mode, most of the circuit blocks are turned off except for the error amplifier and PWM comparator. The operation current is reduced to a minimal value (see Figure 2).

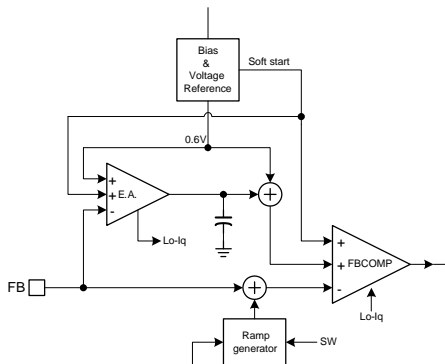

**Figure 2: Operation Blocks at Sleep Mode**

When the load becomes lighter, the ripple of the output voltage becomes larger and drives the error amplifier output (EAO) lower. When the EAO reaches the internal low threshold, it is clamped at that level, and the MP1605 enters sleep mode. During sleep mode, the valley of the FB voltage is regulated to the internal

reference voltage. Therefore, the average output voltage is slightly higher than the output voltage in DCM or CCM. The on-time pulse in sleep mode is around 40% larger than that in DCM or CCM. Figure 3 shows the average FB voltage relationship with the internal reference in sleep mode.

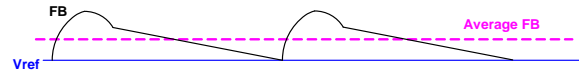

**Figure 3: FB Average Voltage at Sleep Mode**

When the MP1605 is in sleep mode, the average output voltage is higher than the internal reference voltage. The EAO is kept low and clamped in sleep mode. When the load increases, the PWM switching period decreases to keep the output voltage regulated, and the output voltage ripple decreases relatively. Once the EAO is higher than the internal low threshold, the MP1605 exits sleep mode and enters DCM or CCM depending on the load. In DCM or CCM, the error amplifier (EA) regulates the average output voltage to the internal reference (see Figure 4).

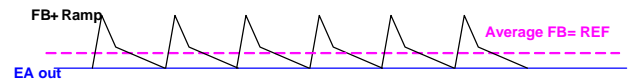

**Figure 4: DCM Control**

There is always a loading hysteresis when entering and exiting sleep mode due to the EA clamping response time.

### AAM Operation at Light-Load Operation

The MP1605 uses advanced asynchronous modulation (AAM) power-save mode with zero-current cross detection (ZCD) circuit for light load.

The MP1605 uses AAM power-save mode for light load. The simplified AAM control theory is shown in Figure 5. The AAM current ( $I_{AAM}$ ) is set internally. The SW on pulse time is determined by the on-time generator and AAM comparator. At light-load condition, the SW on pulse time is longer. If the AAM comparator pulse is longer than the on-time generator, the operation mode is as shown in Figure 6.

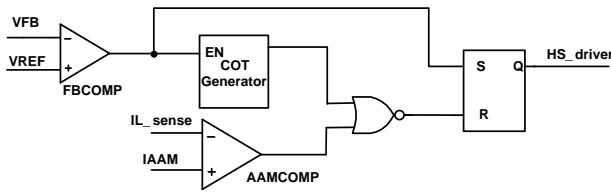
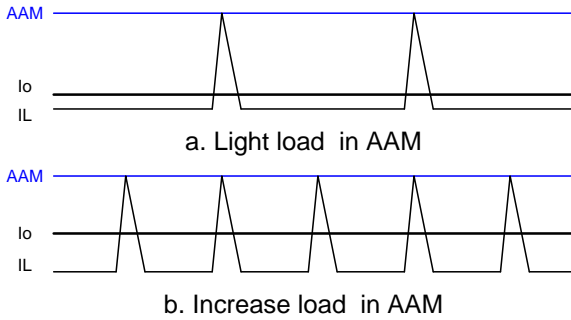
**Figure 5: Simplified AAM Control Logic**

**Figure 6: AAM Comparator Control  $T_{ON}$** 

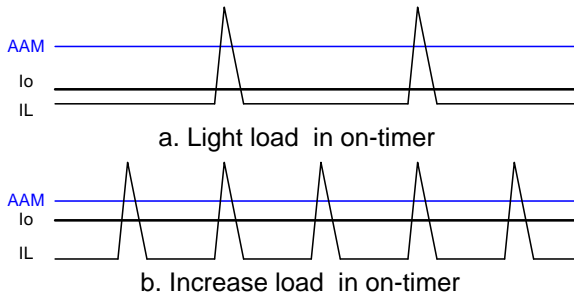
If the AAM comparator pulse is shorter than the on-time generator, the operation mode is as shown in Figure 7. This usually occurs when using a very small inductance.

**Figure 7: On-Timer Control  $T_{ON}$** 

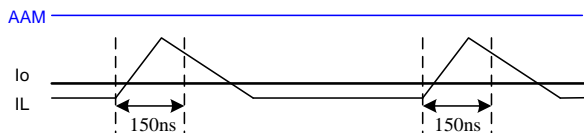
The AAM circuit has another 150ns of AAM blank time in sleep mode. If the on-timer is less than 150ns, the high-side MOSFET may turn off after the on-time generator pulse without AAM control. The on-time pulse at sleep mode is about 40% larger than in DCM or CCM. In this condition,  $I_L$  may not reach the AAM threshold (see Figure 8).

**Figure 8: AAM Blank Time in Sleep Mode**

The AAM threshold decreases as  $T_{ON}$  increases (see Figure 9). For CCM state,  $I_{OUT}$  requires more than half of the AAM threshold.

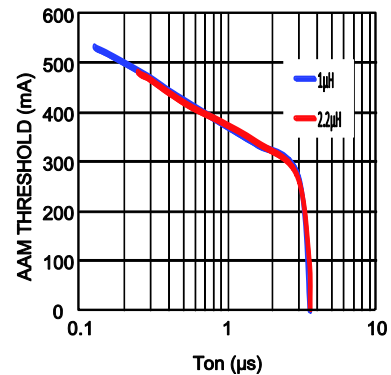
**AAM Threshold vs.  $T_{ON}$** 

**Figure 9: AAM Threshold Decreases as  $T_{ON}$  Increases**

The MP1605 uses a zero-current cross detect circuit (ZCD) to determine when the inductor current begins reversing. When the inductor current reaches the ZCD threshold, the low-side switch is turned off.

AAM mode with the ZCD circuit makes the MP1605 work continuously in DCM at light load, even if  $V_{OUT}$  is close to  $V_{IN}$ .

### Enable (EN)

When the input voltage is greater than the under-voltage lockout (UVLO) threshold (typically 2V), the MP1605 can be enabled by pulling EN higher than 1.2V. Leaving EN floating or pulling it down to ground disables the MP1605. There is an internal 1M $\Omega$  resistor from EN to ground.

When the MP1605 is disabled, the part goes into output discharge mode automatically. The internal discharge MOSFET provides a resistive discharge path for the output capacitor.

### Soft Start (SS)

The MP1605 uses a built-in soft start (SS) that ramps up the output voltage at a controlled slew rate to avoid overshooting at start-up. The soft-start time is about 0.5ms, typically.

**Current Limit**

The MP1605 has a 2.4A, minimum, high-side, switch-current limit. When the high-side switch reaches its current limit, the MP1605 remains in hiccup mode until the current drops. This prevents the inductor current from continuing to rise and damaging components.

**Short Circuit and Recovery**

The MP1605 enters short-circuit protection (SCP) mode when it reaches the current limit and attempts to recover with hiccup mode. The MP1605 disables the output power stage, discharges the soft-start capacitor, and attempts to soft start again automatically. If the short circuit condition remains after the soft start ends, the MP1605 repeats this cycle until the short circuit disappears and the output rises back to regulation levels.

## APPLICATION INFORMATION

### Setting the Output Voltage

The external resistor divider sets the output voltage (see Figure 12). Select the feedback resistor (R1), which reduces the  $V_{OUT}$  leakage current, typically between 40kΩ to 200kΩ. There is no strict requirement on the feedback resistor.  $R1 > 10k\Omega$  is reasonable for most applications. R2 can be calculated with Equation (2):

$$R2 = \frac{R1}{\frac{V_{out}}{0.6} - 1} \quad (2)$$

Figure 10 shows the feedback circuit.

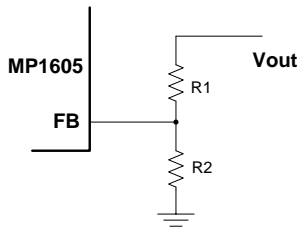

**Figure 10: Feedback Network**

Table 1 lists the recommended resistors value for common output voltages.

**Table 1: Resistor Values for Common Output Voltages**

$V_{OUT}$ (V)	R1 (kΩ)	R2 (kΩ)
1.0	200(1%)	300(1%)
1.2	200(1%)	200(1%)
1.8	200(1%)	100(1%)
2.5	200(1%)	63.2(1%)
3.3	200(1%)	44.2(1%)

### Selecting the Inductor

Most applications work best with a 1µH to 2.2µH inductor. Select an inductor with a DC resistance less than 15mΩ to optimize efficiency.

A high-frequency switch-mode power supply with a magnetic device has strong electronic magnetic inference. Any unshielded power inductors should be avoided. Metal alloy or multi-layer chip power inductors are ideal shielded inductors for the application since they can decrease the influence effectively. Table 2 lists some recommended inductors.

**Table 2: Recommended Inductors**

Manufacturer P/N	Inductance (µH)	Manufacturer
PIFE25201B-1R0MS	1.0	CYNTEC CO. LTD.
1239AS-H-1R0M	1.0	Tokyo
744 777 002	2.2	Würth

For most designs, the inductance value can be estimated with Equation (3):

$$L_1 = \frac{V_{OUT} \times (V_{IN} - V_{OUT})}{V_{IN} \times \Delta I_L \times f_{OSC}} \quad (3)$$

Where  $\Delta I_L$  is the inductor ripple current.

Choose the inductor current to be approximately 30% of the maximum load current. The maximum inductor peak current can be calculated with Equation (4):

$$I_{L(MAX)} = I_{LOAD} + \frac{\Delta I_L}{2} \quad (4)$$

### Selecting the Input Capacitor

The input current to the step-down converter is discontinuous and therefore requires a capacitor to supply AC current to the step-down converter while maintaining the DC input voltage. Use low ESR capacitors for the best performance. Ceramic capacitors with X5R or X7R dielectrics are highly recommended because of their low ESR and small temperature coefficients. For most applications, a 10µF capacitor is sufficient. Higher output voltages may require a 22µF capacitor to increase system stability.

The input capacitor requires an adequate ripple current rating since it absorbs the input switching current. Estimate the RMS current in the input capacitor with Equation (5):

$$I_{C1} = I_{LOAD} \times \sqrt{\frac{V_{OUT}}{V_{IN}} \times \left(1 - \frac{V_{OUT}}{V_{IN}}\right)} \quad (5)$$

The worst-case scenario occurs at  $V_{IN} = 2V_{OUT}$ , shown in Equation (6):

$$I_{C1} = \frac{I_{LOAD}}{2} \quad (6)$$

For simplification, choose an input capacitor with an RMS current rating greater than half of the maximum load current.

The input capacitor can be electrolytic, tantalum, or ceramic. When using electrolytic or tantalum capacitors, add a small, high-quality, 0.1µF ceramic capacitor as close to the IC as possible. When using ceramic capacitors, ensure that they have enough capacitance to provide sufficient charge to prevent excessive voltage ripple at the input. The input voltage ripple caused by capacitance can be estimated with Equation (7):

$$\Delta V_{IN} = \frac{I_{LOAD}}{f_s \times C1} \times \frac{V_{OUT}}{V_{IN}} \times \left(1 - \frac{V_{OUT}}{V_{IN}}\right) \quad (7)$$

### Selecting the Output Capacitor

The output capacitor (C2) stabilizes the DC output voltage. Ceramic capacitors are recommended. Use low ESR capacitors to limit the output voltage ripple. Estimate the output voltage ripple with Equation (8):

$$\Delta V_{OUT} = \frac{V_{OUT}}{f_s \times L_1} \times \left(1 - \frac{V_{OUT}}{V_{IN}}\right) \times \left(R_{ESR} + \frac{1}{8 \times f_s \times C2}\right) \quad (8)$$

Where  $L_1$  is the inductor value, and  $R_{ESR}$  is the equivalent series resistance (ESR) value of the output capacitor.

When using ceramic capacitors, the capacitance dominates the impedance at the switching frequency and causes most of the output voltage ripple. For simplification, the output voltage ripple can be estimated with Equation (9):

$$\Delta V_{OUT} = \frac{V_{OUT}}{8 \times f_s^2 \times L_1 \times C2} \times \left(1 - \frac{V_{OUT}}{V_{IN}}\right) \quad (9)$$

For tantalum or electrolytic capacitors, the ESR dominates the impedance at the switching frequency. For simplification, the output ripple can be approximated with Equation (10):

$$\Delta V_{OUT} = \frac{V_{OUT}}{f_s \times L_1} \times \left(1 - \frac{V_{OUT}}{V_{IN}}\right) \times R_{ESR} \quad (10)$$

The characteristics of the output capacitor also affect the stability of the regulation system.

### PCB Layout Guidelines

Efficient PCB layout is critical for stable operation. For the high-frequency switching converter, a poor layout design can result in poor line or load regulation and stability issues. For best results, refer to Figure 11 and follow the guidelines below.

- 1) Place the high-current paths (GND, IN, and SW) as close to the device as possible with short, direct, and wide traces.
- 2) Keep the input capacitor as close to IN and GND as possible.
- 3) Place the external feedback resistors next to FB.
- 4) Keep the switching node SW short and away from the feedback network.
- 5) Keep the  $V_{OUT}$  sense line as short as possible or keep it away from the power inductor and the surrounding inductors.

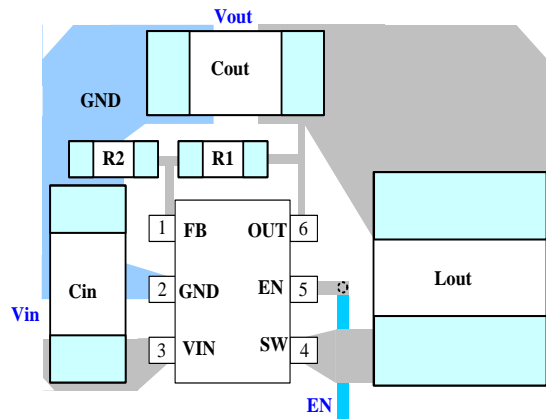

**Figure 11: Two Ends of Input Decoupling Capacitor Close to Pin 2 and Pin 3**



### TYPICAL APPLICATION CIRCUITS

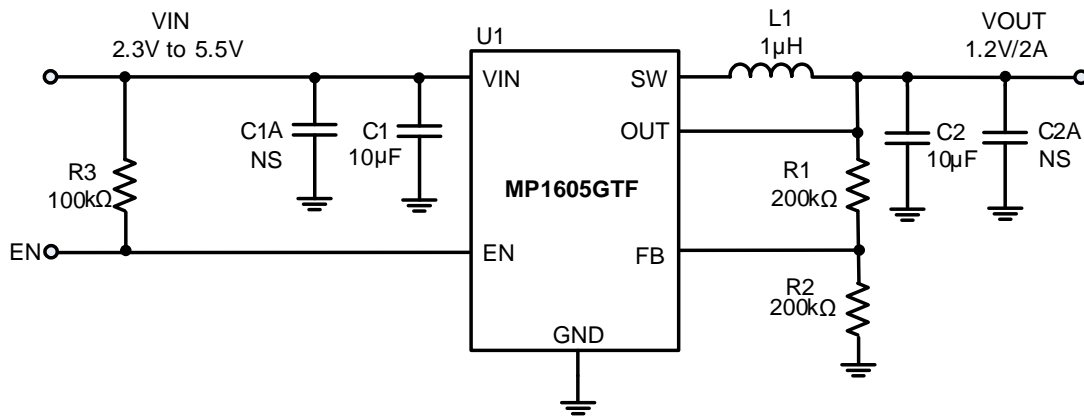
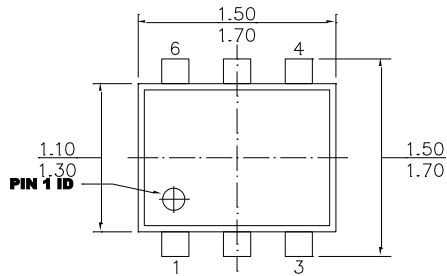

**Figure 12: Typical Application Circuit for MP1605GTF**

**NOTE:**  $V_{IN} < 3.3V$  may require more input capacitors.

## PACKAGE INFORMATION

### SOT563



**TOP VIEW**

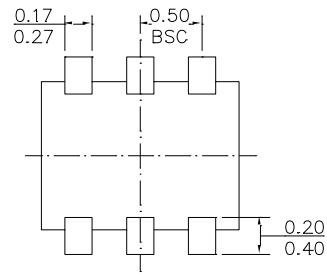

**BOTTOM VIEW**



**FRONT VIEW**

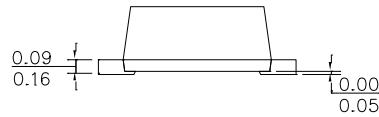

**SIDE VIEW**

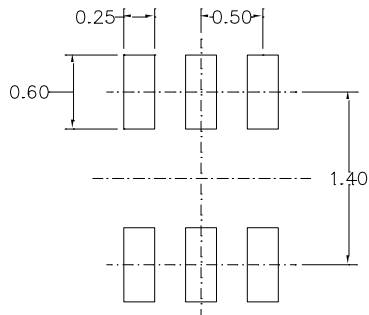

**RECOMMENDED LAND PATTERN**

**NOTE:**

- 1) ALL DIMENSIONS ARE IN MILLIMETERS.
- 2) PACKAGE LENGTH DOES NOT INCLUDE MOLD FLASH, PROTRUSION OR GATE BURR.
- 3) PACKAGE WIDTH DOES NOT INCLUDE INTERLEAD FLASH OR PROTRUSION.
- 4) LEAD COPLANARITY (BOTTOM OF LEADS AFTER FORMING) SHALL BE 0.10 MILLIMETERS MAX.
- 5) DRAWING IS NOT TO SCALE.

**NOTICE:** The information in this document is subject to change without notice. Please contact MPS for current specifications. Users should warrant and guarantee that third party Intellectual Property rights are not infringed upon when integrating MPS products into any application. MPS will not assume any legal responsibility for any said applications.