

KC 系列大电流翘板开关

KC series power rocker switches



- 凹陷式翘板设计，防滑防误操作
Recessed non-skid rocker
- 滚轮式开关机构，手感优异寿命长
Excellent feel and reliability benefit by roller switching mechanism
- 高亮度背光配合大尺寸透镜，图标清晰显眼
Large lens within nice illumination produce distinct symbol
- 家族化产品，完善的附件及配套产品
Plenty of accessories and complement product from the family

电气规格 - ELECTRICAL SPECIFICATIONS

- 额定电流 / 电压 - Current/voltage rating
阻性负载 - resistive load :
5A 24VDC, 50 000 cycles ; 10A 24VDC, 10 000 cycles
灯泡负载 - lamp load :
100W 24VDC, 10 000 cycles
- 初始接触电阻 - Initial contact resistance : 10 mΩ max.
- 绝缘电阻 - Insulation resistance : 1 000 MΩ min. at 500VDC
- 介电强度 - Dielectric strength :
2 000 Vrms 50 Hz min. between terminals
- 机械寿命 - Mechanical life : 50 000 cycles min.

环境规格 - ENVIRONMENTAL SPECIFICATIONS

- 面板正面密封等级 - Frontal panel sealing grade : IP65
- 盐雾测试 - Salt spray resistance (IEC 512-6, test 11f) :
96 小时 - 96 hours
- 工作温度范围 - Operating temperature : -40°C to +85°C

外形尺寸 - DIMENSIONS

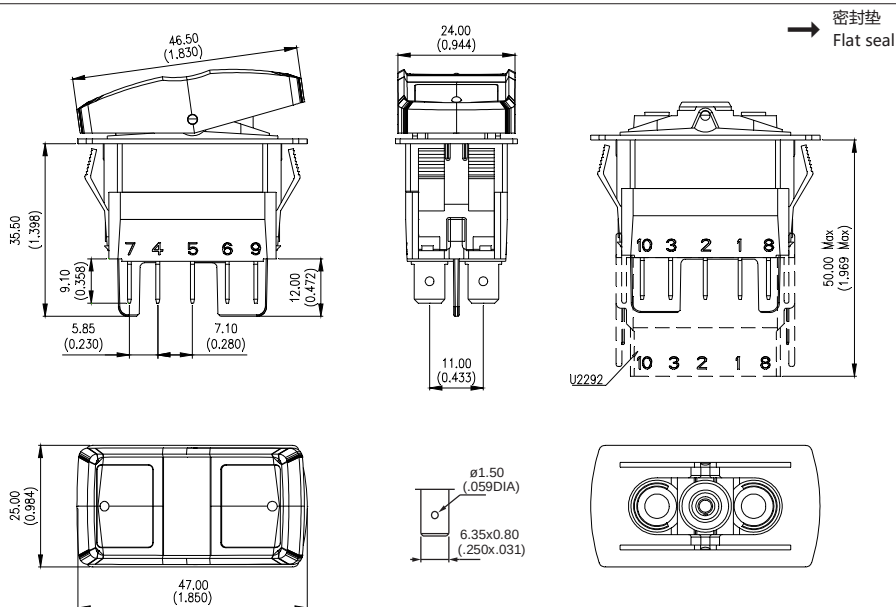

材质 - MATERIALS

- 底座 - Case : PBT
- 翘板 - Actuator : PA
- 上盖 - Bezel : PA
- 触点及引脚 -
Contacts & terminals :
黄铜镀银 - brass, silver plated

关于密封防护 - SEALING

面板正面密封防护是可选的。如有需要，请根据后续选型说明，在相应配置项中进行选择。

Sealing is optional. To order a sealed product, complete the appropriate box of ordering format on the following pages.

面板开孔尺寸 - PANEL CUT-OUT

面板厚度：0.8mm 到 4.6mm
推荐面板厚度：2.0mm 到 3.5mm

Panel thickness : 0.8mm to 4.6mm
Recommended panel thickness :
Between 2.0mm and 3.5mm

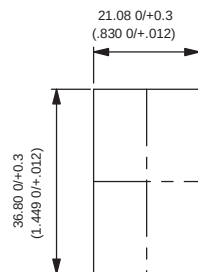

标准包装
Packaging unit **40** 个
Pieces

KC 系列大电流翘板开关

KC series power rocker switches

型号编码规则

Ordering Guide

请依次从以下各配置选项中选择需要的配置代码，组成一个完整的产品型号。
To order a complete product, fill in all the boxes of the following ordering guide.

开关基座 - CASE + LEADS

KC							A 端 Side A	B 端 Side B	
系列 Series	电气功能 Electrical functions			触点材质 Contacts	正面密封 Sealing	背光 LED LEDS		接线配置 Wiring	
极数 Poles	4	ON	ON	ON	A 银合金 Silver	X No K IP65	X 无 - None D 12V 红色 12V red E 12V 绿色 12V green F 12V 黄色 12V yellow S 12V 白色 12V white J 24V 红色 24V red K 24V 绿色 24V green L 24V 黄色 24V yellow T 24V 白色 24V white	G 标准 10 脚配置 Standard 10-term.	
3 单极 Single pole 4 双极 Double pole	4-1R	ON	ON	MOM	引脚 Terminals				
	5	MOM	-	ON	F 6.35x0.8 快插脚 Quick-connect 6.35x0.8				
	6	ON	-	ON					
	7	MOM	OFF	MOM					
	8	ON	OFF	MOM					
	9	ON	OFF	ON					

翘板 - Rocker

	A 端 Side A	B 端 Side B			A 区 Area A	B 区 Area B	C 区 Area C
翘板颜色 Colour	透镜 Lens	图标工艺 Marking Method	图标方向 Orientation		图标代码 Symbols		
2 黑色 Black 6 红色 Red	X 无 - None B 白色 White 6 红色 Red	X 无图标 - None B 镭雕 Laser Etching	N	S	7 8 4 1 5 2 6 3 9 10		
			W	E	7 8 4 1 5 2 6 3 9 10		
					7 8 4 1 5 2 6 3 9 10		



注意 根据以上编码规则得到的型号并非所有的组合都是可行的，详情请见后续说明。
NOTICE Please note that not all combinations of above numbers are available. Refer to the following pages for further information.

KC 系列大电流翘板开关

KC series power rocker switches

开关基座 - CASE + LEDS

开关功能配置
MODEL STRUCTURE

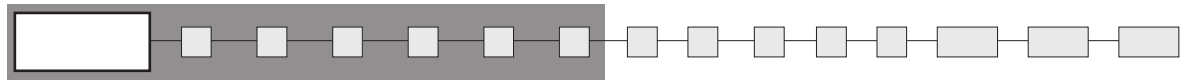

单刀开关 Single pole
双刀开关 Double pole

	2-3 5-6	1-2 4-5
KC35	ON	ON
KC36	MOM	-
KC37	MOM	OFF
KC38	ON	OFF
KC39	ON	OFF
KC44 *	ON	ON
KC44-1R *	ON	MOM
KC45	MOM	ON
KC46	ON	ON
KC47	MOM	MOM
KC48	ON	MOM
KC49	ON	ON

开关功能引脚
Contact area

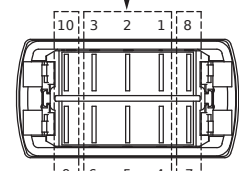

LED 引脚
LED area

* 功能 4 : 通过双刀开关的实体实现特殊的单刀功能
Function 4 : single pole in double pole case

电气功能原理图

ELECTRICAL FUNCTIONS AND CONNECTIONS

以下电气功能原理图均基于开关底视图的引脚排列，并只显示了开关功能引脚。
单刀开关只有 1、2、3 号引脚，4、5、6 号引脚只出现在双刀开关上。

In the tables below, terminal connections as viewed from bottom of switch.
Only the contact area is represented.

For single pole models, only terminals 1, 2 and 3 are to be considered (not terminals 4, 5, 6).

○ = 保持型
maintained

▲ = 自复位
momentary

	Positions				Positions		
				Function 8 KC38-KC48			
Function 5 KC35-KC45				Function 9 KC39-KC49			
Function 6 KC36-KC46				Function 4 KC44			
Function 7 KC37-KC47				Function 4-1R KC44-1R			

KC 系列大电流翘板开关

KC series power rocker switches

引脚 TERMINALS

开关基座 - CASE + LEDS

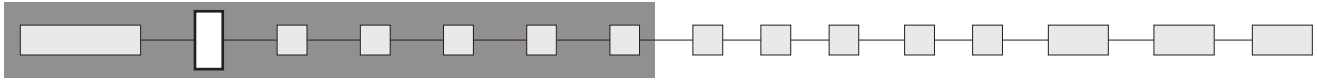

F 6.35x0.8 快插脚 - Quick-connect 6.35x0.8

触点材质 CONTACT MATERIALS

开关基座 - CASE + LEDS

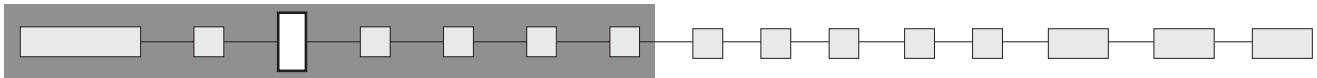

A 银合金 - Silver

正面密封 SEALING

开关基座 - CASE + LEDS

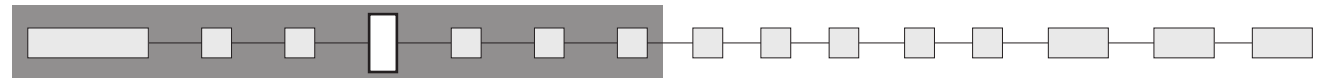

X 无 - No sealing

K IP65 (仅限面板正面元器件 - front panel components of switch only)

背光 LED LEDS

开关基座 - CASE + LEDS

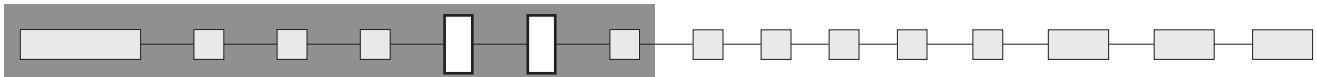

A 端 Side A
B 端 Side B

从以下列表中选择需要的背光 LED 代码，依次填入对应的位置。
Complete each enlarged box with one of the codes listed below.

X 无 LED - Without LED

	红色 Red	绿色 Green	黄色 Yellow	蓝色 Blue	白色 White
12VDC	D	E	F	N	S
24VDC	J	K	L	P	T

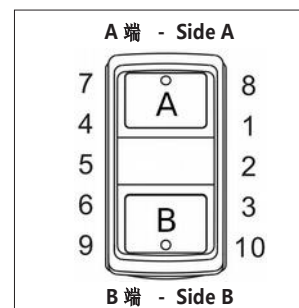

LED 消耗电流 : 20mA (25°C 时典型值)
LED consumption : 20mA @ nominal voltage (25°C)

接线配置 WIRING

开关基座 - CASE + LEDS

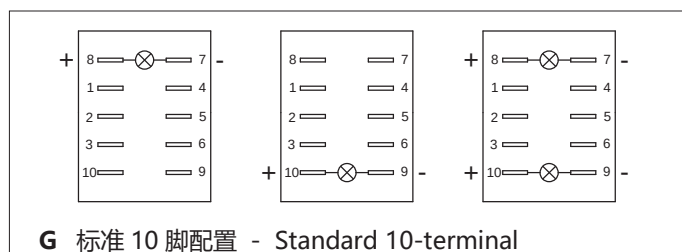
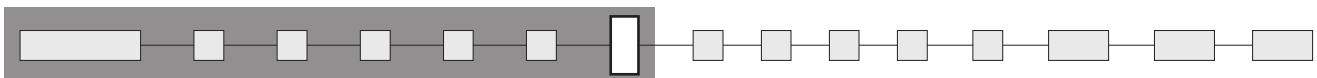

LED 接线详情将标识于开关壳体上。
The LED wiring diagram is shown on the case.

KC 系列大电流翘板开关

KC series power rocker switches

翘板颜色 ROCKER COLOUR



2 黑色 - Black

6 红色 - Red

透镜 LENS

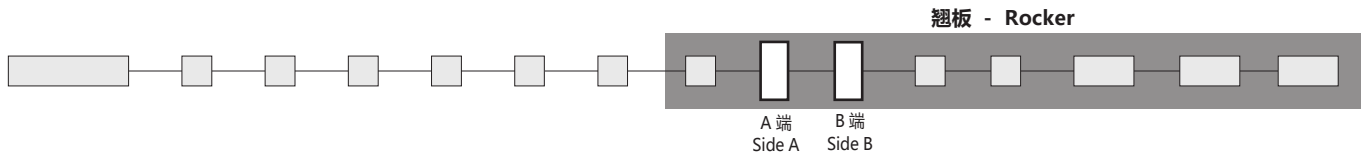

从以下列表中选择需要的透镜代码，依次填入对应的位置。
Complete each enlarged box with one of the codes listed below.

X 无透镜 - Without Lens

B 白色 - White

6 红色 - Red

图标工艺 MARKING METHOD

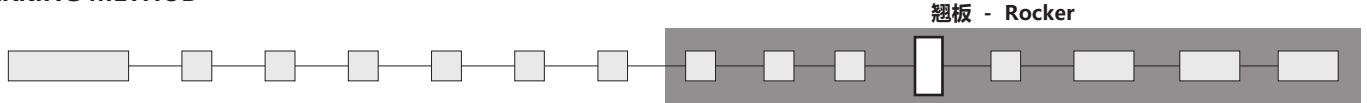

X 无图标 - Without Marking

B 镭雕 - Laser Etching

图标方向 MARKING ORIENTATION

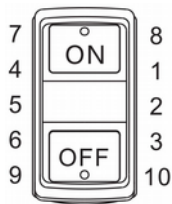
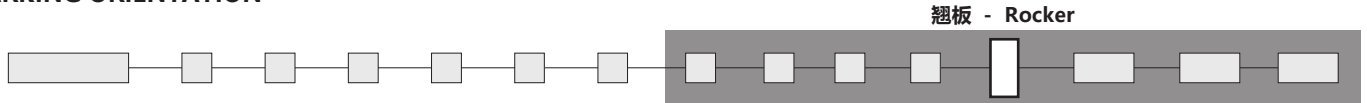

N

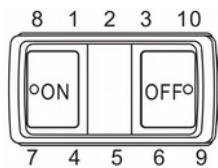

W

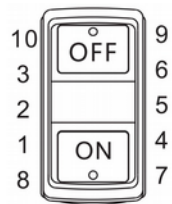

S

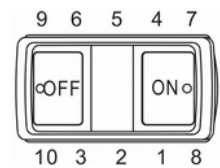

E

图标代码 SYMBOLS

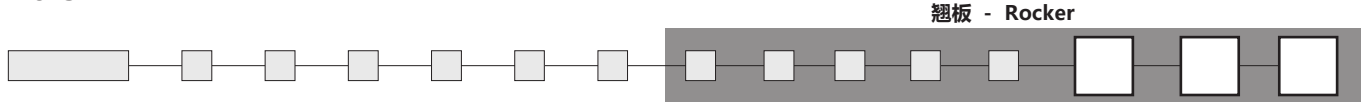

选择需要的图标代码，依次填入对应的位置。
Complete each enlarged box with needed symbol code.

XXX 无图标 - Without Marking

其他大量现成图标，详情请咨询 APEM。
Lots of existing symbols, please consult APEM for the detail.

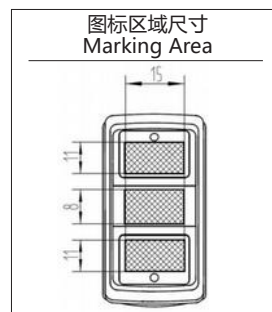

A区 Area A M区 Area M B区 Area B

