

# 8000 series

Momentary or alternate action  
pushbutton switches



## DISTINCTIVE FEATURES

Momentary or alternate

Bushing  $\varnothing$  6.35 (1/4) and  $\varnothing$  11.9 (15/32)

UL approved



## ELECTRICAL SPECIFICATIONS

- Max. current/voltage rating with resistive load :
  - silver contacts : 4 A 30 VDC
  - gold plated contacts : 0.4 VA max. 20 VAC or DC
- Initial contact resistance : 10 m $\Omega$  max.
- Insulation resistance : 1,000 M $\Omega$  min. at 500 VDC
- Dielectric strength :
  - 1,000 Vrms 50 Hz min. between terminals
  - 2,000 Vrms 50 Hz min. between terminals and frame
- Electrical life : 30,000 cycles at full load



## GENERAL SPECIFICATIONS

- Torque : 1.25 Nm (.922 Ft.lb) max. applied to nut
- Total travel : 2.70 mm (.106)
- Operating temperature : -40 °C to +85 °C (-40 °F to +185 °F)



## MATERIALS

- Case : diallyphthalate (DAP)
- Actuator : brass, nickel plated
- Bushing : brass, nickel plated
- Housing : stainless steel
- Contacts
  - A : silver
  - AD : silver, gold plated
  - CD : brass, gold plated
- Terminal seal : epoxy

APEM products may be recycled at end-of-life for the re-claiming of valuable metal components.

The company reserves the right to change specifications without notice.

4006-022-002

shunto@126.com



# 8000 series

Momentary or alternate action pushbutton switches

## AGENCY APPROVAL



3 A 250 VAC,  
6 A 125 VAC

**Availability** : consult factory for details of approved models.

**Marking** : to order switches marked UL, complete appropriate box of ordering format.



## TERMINALS

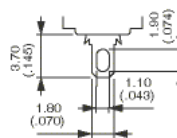

Solder lug

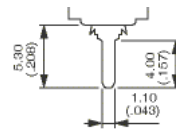

Straigh PC



## PANEL CUT-OUT

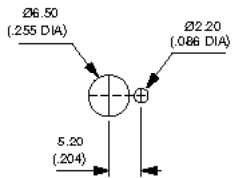

Standard

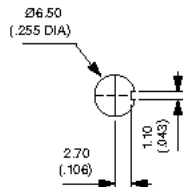

With K sealing option



## ELECTRICAL FUNCTIONS

→ KEYWAY

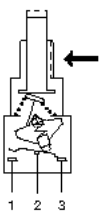

Funct. 6 (ON-ON)

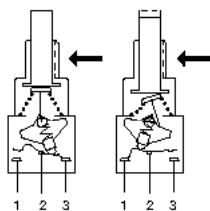

Funct. 2 (ON-MOM)

# 8000 series

Momentary or alternate action pushbutton switches



## BUILD YOUR PART NUMBER

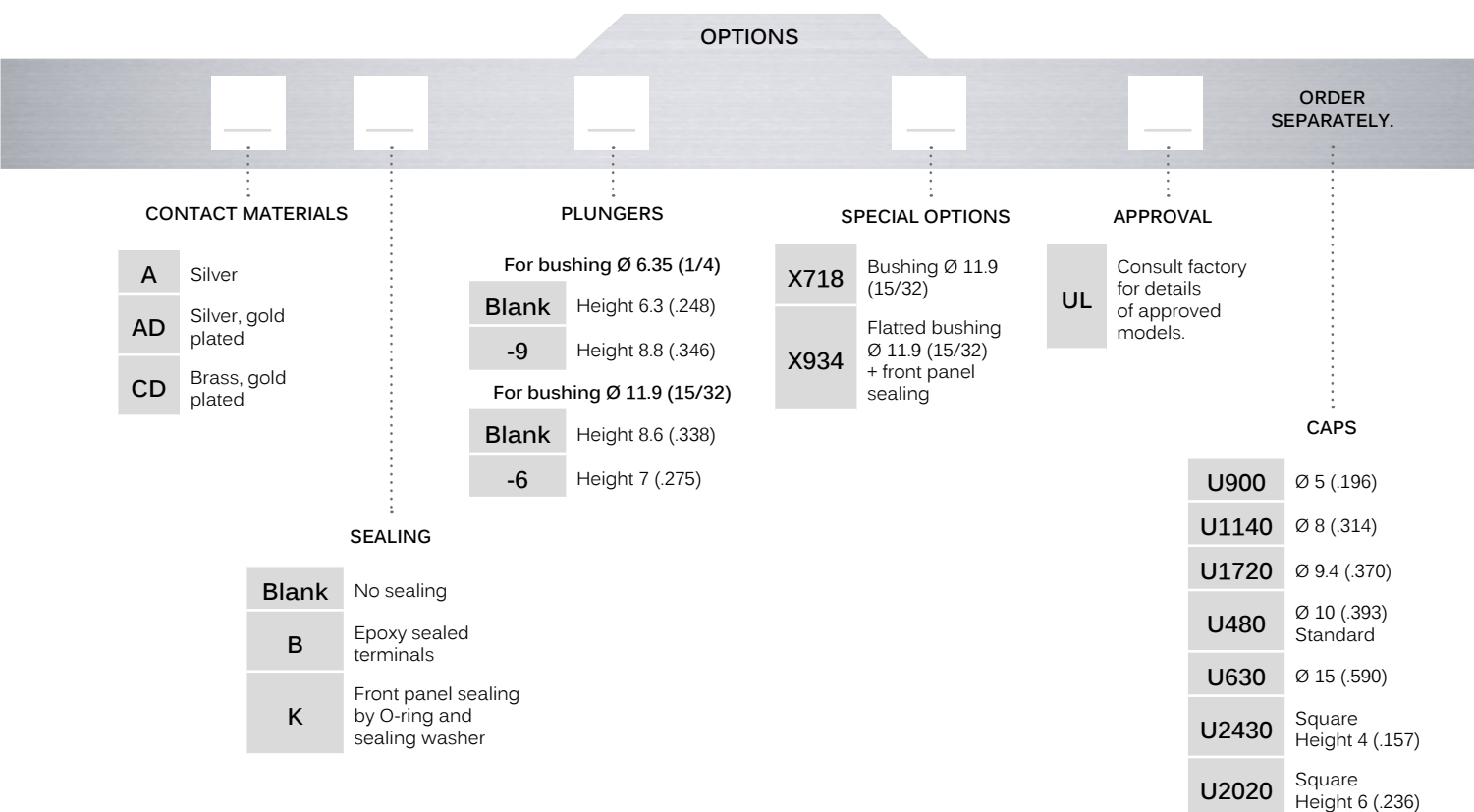
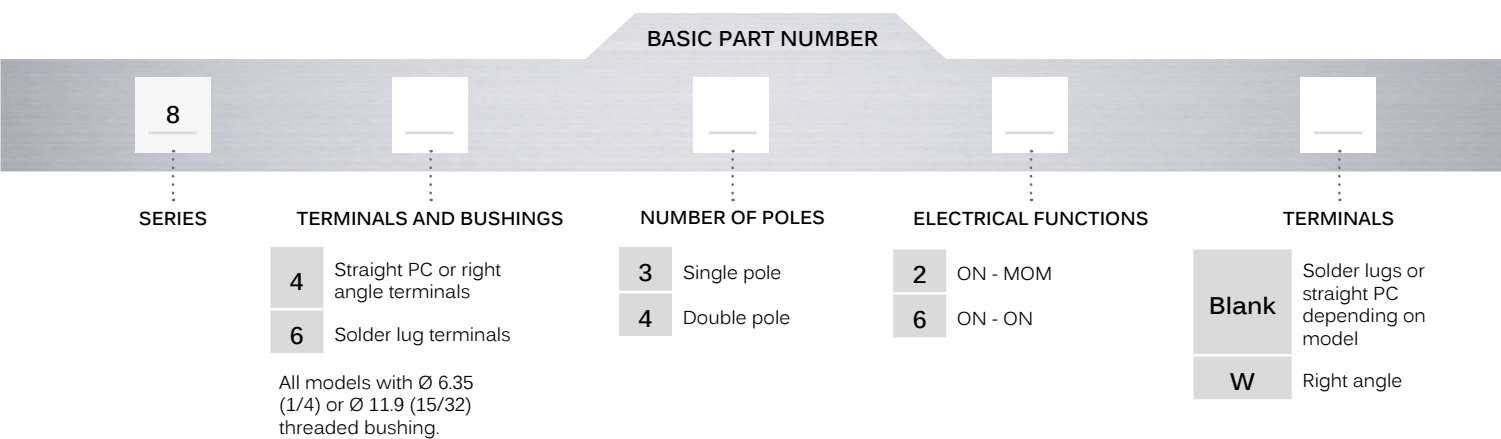

## ABOUT THIS SERIES

On the following pages, you will find successively basic part numbers of switches and options in the same order as in above chart.

- ⚠ **Notice** : please note that not all combinations of above numbers are available. Refer to the following pages for further information.
- 🔒 **Sealing boots** are available to protect the switches against dust and water. See "Sealing Boots" section of website.
- 🔧 **Mounting accessories** : standard hardware supplied with all models : 2 hex nuts 8 mm (.314) across flats, 1 locking ring and 1 lockwasher (Sealing option "K" : lockwasher not supplied). Standard and special hardware available is presented in the "Hardware" section of website.

# 8000 series

Momentary or alternate action pushbutton switches

## SOLDER LUG TERMINALS : 8600



Single pole

8632



2-3

ON



1-2

MOM

8636

ON

ON

Double pole

8642

2-3

ON

1-2

MOM

8646

5-6

ON

4-5

ON

## STRAIGHT PC TERMINALS : 8400



Single pole

8432



2-3

ON



1-2

MOM

8436

ON

ON

Double pole

8442

2-3

ON

1-2

MOM

8446

5-6

ON

4-5

ON

## RIGHT ANGLE TERMINALS HORIZONTAL : 8400W



Single pole

8432W



2-3

ON



1-2

MOM

8436W

ON

ON

Double pole

8442W

2-3

ON

1-2

MOM

8446W

5-6

ON

4-5

ON

KEYWAY

Shown with standard plunger

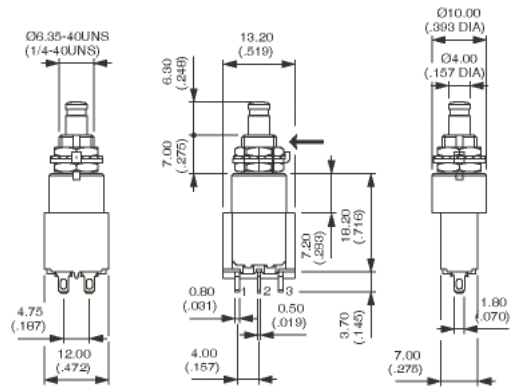

KEYWAY

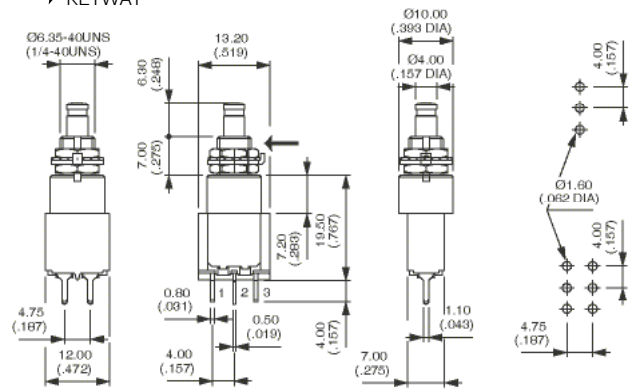

KEYWAY

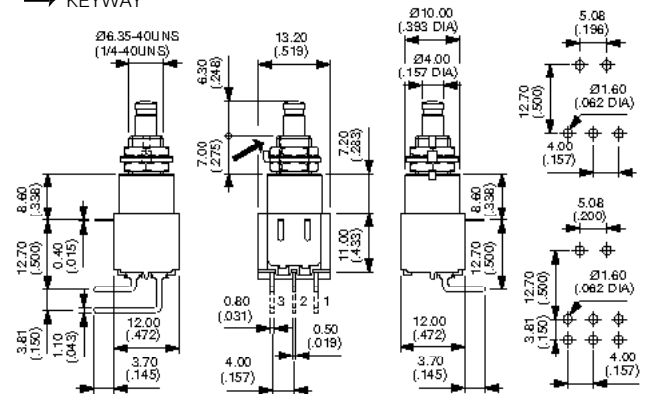

# 8000 series

Momentary or alternate action pushbutton switches

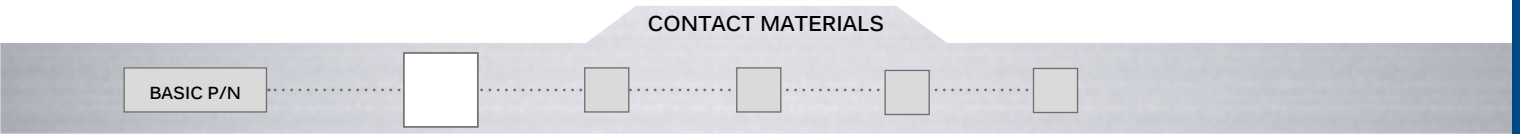

- A Silver
- AD Silver, gold plated
- CD Brass, gold plated

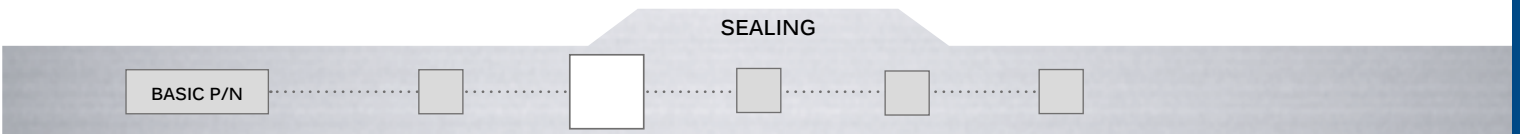

- Blank No sealing
  - K Frontal sealing by O-ring and sealing washer. Protects the switch against water and dust. Panel seal withstands 1 bar pressure.
  - B Epoxy sealed terminals
  - KB Combined sealings
- Sealing boot : see "Sealing boots" section of website.

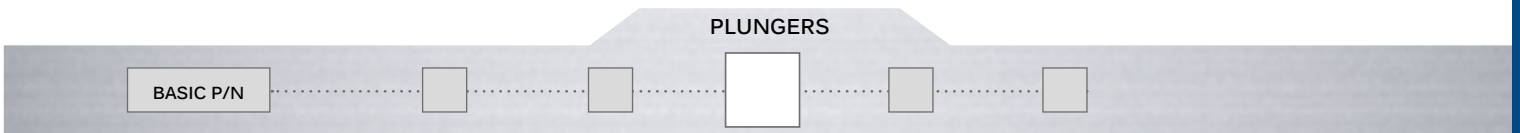
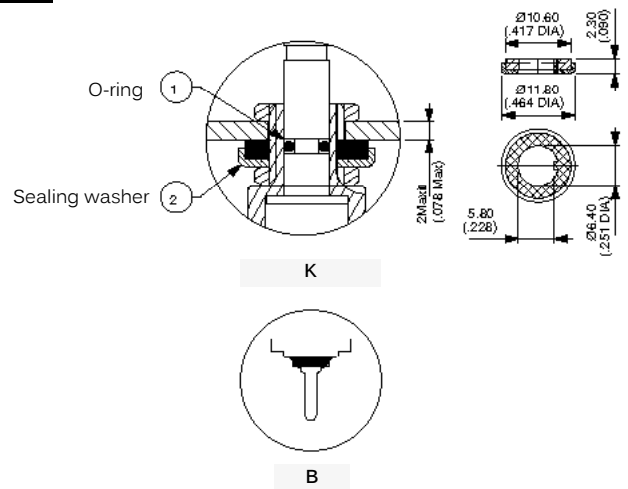

Dash compulsory before plunger code.

FOR Ø 6.35 (1/4) BUSHING

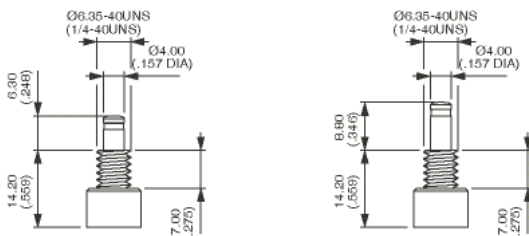

Blank Standard

-9

FOR Ø 11.9 (15/32) BUSHING (X718 MODELS)

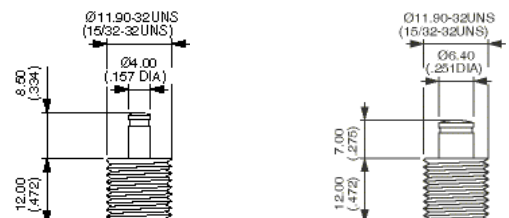

Blank Standard

-6

# 8000 series

Momentary or alternate action pushbutton switches

### SPECIAL OPTIONS

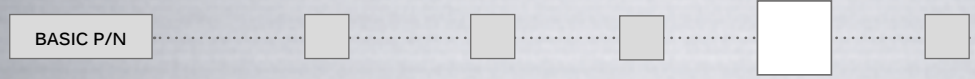

- X601** Silver plated brass contacts  
Current/voltage rating for an electrical life of 20,000 cycles : 0.5 A 30 VDC.  
Minimum quantity : 5,000 pieces per model and shipment.
- X718** Bushing Ø 11.9 (15/32)  
For all basic models (solder lug, straight PC or right angle terminals)  
Available with plungers shown on previous page (Standard and -6)  
K sealing option available.
- X748** Snap-in mounting. Consult factory.  
Panel cut-out 15 x 12.5 (.59 x .492)
- X934** Flatted bushing Ø 11.9 (15/32) + sealing by two O-rings (for plunger -6 only).  
Epoxy sealed terminals.

#### OPTION X718

→ KEYWAY

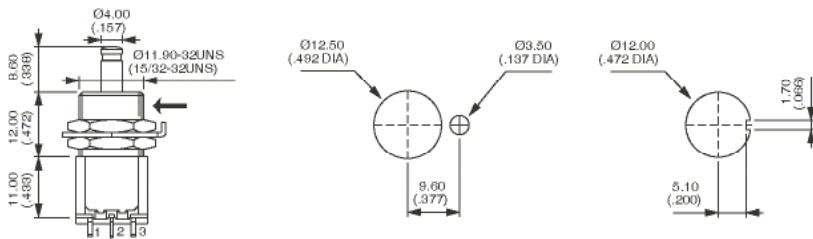

#### OPTION X934

→ KEYWAY

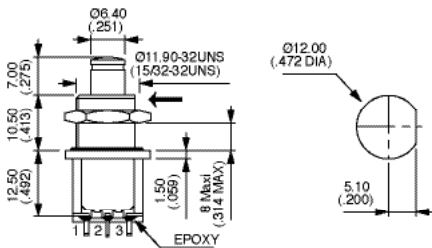

### AGENCY APPROVAL

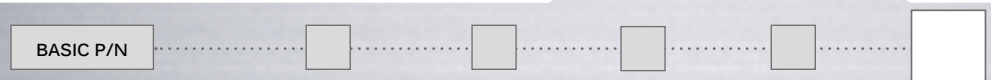

#### UL

**Availability** : consult factory for details of approved models.

**Marking** : to order switches marked UL, complete above box with "UL".

# 8000 series

Momentary or alternate action pushbutton switches

## CAPS

### Order separately

The caps below are for  $\varnothing 4$  mm plungers (standard and -9), except U2600.

### Cap colors

Replace last "0" by number :

- 1 Blue
- 1/4 Dark blue
- 2 Black
- 3 Green
- 4 Grey
- 5 Yellow
- 6 Red
- 7 Ivory
- 7/1 White
- 9 Orange

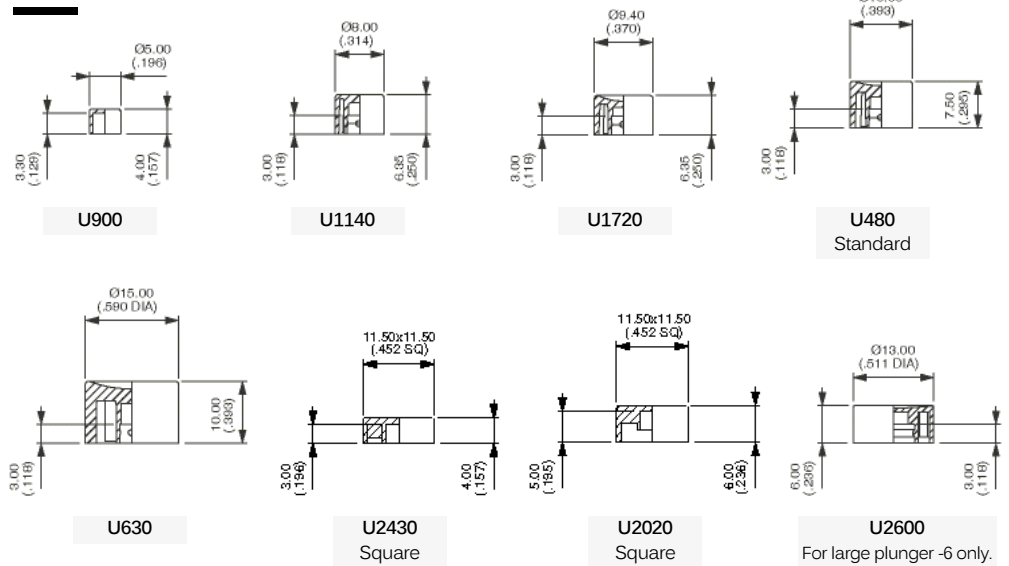

## DRESS NUTS

### Order separately

Chrome plated.

