

5P~15P

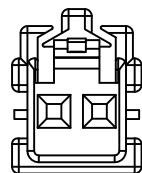

2P

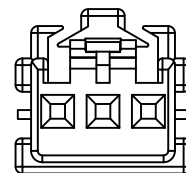

3P

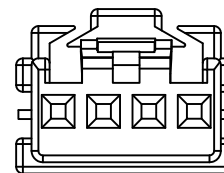

4P

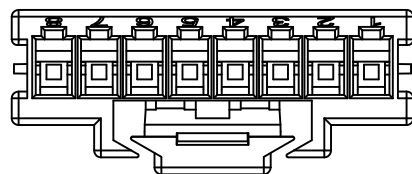
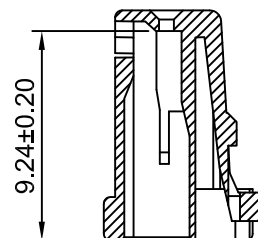
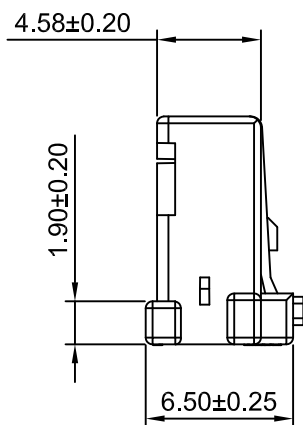
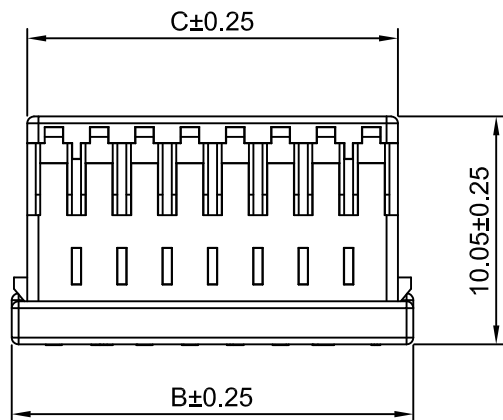

Ordering Information:

C2003HFB-XP - \*\*\* - \*\*\*  
1 2 3

1.Part NO.

2.Material:

(blank): PBT,UL94V-0(White)

GWT: Nylon 66,UL94V-0(Beige),

IEC 60335-1,5th Edition

Glow Wire Capable.

3.Color:

BL: Blue BK: Black

GN: Green GY: Gray

RD: Red YL: Yellow

LG: Light Green

SPECIFICATIONS:

Current Rating: 3A AC,DC (AWG #22)

Voltage Rating: 100V AC,DC

Temperature Range: -40°C ~ +105°C

Contact Resistance: 15mΩ Max

Insulation Resistance: 1000MΩ Min

Withstanding Voltage: 800V AC/minute

Material: PBT, UL94V-0

Ordering Information & Dimensions

| Part NO.     | Dimensions(mm) |       |       |
|--------------|----------------|-------|-------|
|              | A              | B     | C     |
| C2003HFB-2P  | 2.00           | 5.71  | 4.35  |
| C2003HFB-3P  | 4.00           | 7.71  | 6.35  |
| C2003HFB-4P  | 6.00           | 9.71  | 8.35  |
| C2003HFB-5P  | 8.00           | 11.71 | 10.35 |
| C2003HFB-6P  | 10.00          | 13.71 | 12.35 |
| C2003HFB-8P  | 14.00          | 17.71 | 16.35 |
| C2003HFB-10P | 18.00          | 21.71 | 20.35 |
| C2003HFB-12P | 22.00          | 25.71 | 24.35 |
| C2003HFB-14P | 26.00          | 29.71 | 28.35 |
| C2003HFB-15P | 28.00          | 31.71 | 30.35 |

**CJT** CHANGJIANG CONNECTORS CO.,LTD.

| Unit   | Scale       | Sheet      | TITLE                  |
|--|-------------|------------|------------------------|
| mm   | 3:1         | 1 of 1     | 2.00mm PITCH HOUSING   |
| DRWN   | CHK'D       | APPR       |                        |
| Dengchun Yi  | Diankui Wan | Jack Yin   |                        |
| General Tolerances                                   |             |            | THIRD ANGLE PROJECTION |
| x.xx±0.25<br>x.xxx±0.20<br>x.xxxx±0.15<br>ANGLES ±1° |             |            | DRAWING NO.            |
| A0   | NEW RELEASE | 2018.04.03 | C2003HFB-XP            |
| REV  | DESCRIPTION | DATE       | REV A0                 |