

NTJD4105C

MOSFET – Small Signal, Complementary, SC-88 20 V / -8.0 V, +0.63 A / -0.775 A

Features

- Complementary N and P Channel Device
- Leading -8.0 V Trench for Low $R_{DS(on)}$ Performance
- ESD Protected Gate – ESD Rating: Class 1
- SC-88 Package for Small Footprint (2 x 2 mm)
- Pb-Free Packages are Available

Applications

- DC-DC Conversion
- Load/Power Switching
- Single or Dual Cell Li-Ion Battery Supplied Devices
- Cell Phones, MP3s, Digital Cameras, PDAs

MAXIMUM RATINGS ($T_J = 25^\circ\text{C}$ unless otherwise noted)

Parameter	Symbol	Value	Unit	
Drain-to-Source Voltage	N-Ch	V_{DSS}	20	V
	P-Ch		-8.0	
Gate-to-Source Voltage	N-Ch	V_{GS}	± 12	V
	P-Ch		± 8.0	
Continuous Drain Current – Steady State (Based on $R_{\theta JA}$)	N-Ch	$T_A = 25^\circ\text{C}$	0.63	A
		$T_A = 85^\circ\text{C}$	0.46	
	P-Ch	$T_A = 25^\circ\text{C}$	-0.775	
		$T_A = 85^\circ\text{C}$	-0.558	
Continuous Drain Current – Steady State (Based on $R_{\theta JL}$)	N-Ch	$T_A = 25^\circ\text{C}$	0.91	
		$T_A = 85^\circ\text{C}$	0.65	
	P-Ch	$T_A = 25^\circ\text{C}$	-1.1	
		$T_A = 85^\circ\text{C}$	-0.8	
Pulsed Drain Current	$tp \leq 10 \mu\text{s}$	I_{DM}	± 1.2	A
Power Dissipation – Steady State (Based on $R_{\theta JA}$)	$T_A = 25^\circ\text{C}$	P_D	0.27	W
	$T_A = 85^\circ\text{C}$		0.14	
Power Dissipation – Steady State (Based on $R_{\theta JL}$)	$T_A = 25^\circ\text{C}$		0.55	
	$T_A = 85^\circ\text{C}$		0.29	
Operating Junction and Storage Temperature	T_J, T_{STG}		-55 to 150	$^\circ\text{C}$
Source Current (Body Diode)	N-Ch	I_S	0.63	A
	P-Ch		-0.775	
Lead Temperature for Soldering Purposes (1/8" from case for 10 s)	T_L		260	$^\circ\text{C}$

THERMAL RESISTANCE RATINGS (Note 1)

Parameter	Typ	Max	Unit	
Junction-to-Ambient – Steady State	Typ	$R_{\theta JA}$	400	$^\circ\text{C}/\text{W}$
	Max		460	
Junction-to-Lead (Drain) – Steady State	Typ	$R_{\theta JL}$	194	
	Max		226	

Stresses exceeding Maximum Ratings may damage the device. Maximum Ratings are stress ratings only. Functional operation above the Recommended Operating Conditions is not implied. Extended exposure to stresses above the Recommended Operating Conditions may affect device reliability.

1. Surface mounted on FR4 board using 1 oz Cu area = 0.9523 in sq.



ON Semiconductor®

<http://onsemi.com>

$V_{(BR)DSS}$	$R_{DS(on)}$ TYP	I_D Max
N-Ch 20 V	0.29 Ω @ 4.5 V	0.63 A
	0.36 Ω @ 2.5 V	
P-Ch -8.0 V	0.22 Ω @ -4.5 V	-0.775 A
	0.32 Ω @ -2.5 V	
	0.51 Ω @ -1.8 V	

SOT-363 SC-88 (6-LEADS)

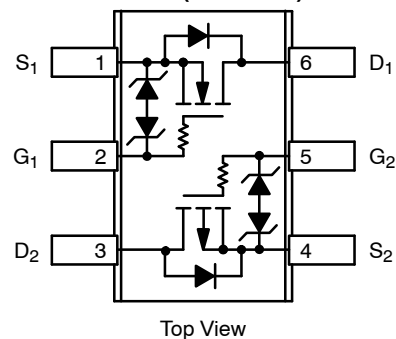

Top View

MARKING DIAGRAM & PIN ASSIGNMENT

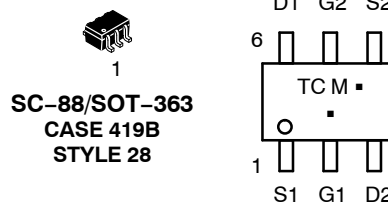

TC = Device Code
M = Date Code
▪ = Pb-Free Package

(Note: Microdot may be in either location)

ORDERING INFORMATION

See detailed ordering and shipping information in the package dimensions section on page 7 of this data sheet.

NTJD4105C

ELECTRICAL CHARACTERISTICS (T_J = 25°C unless otherwise noted)

Parameter	Symbol	N/P	Test Condition	Min	Typ	Max	Units	
OFF CHARACTERISTICS								
Drain-to-Source Breakdown Voltage	V _{(BR)DSS}	N	V _{GS} = 0 V	I _D = 250 μA	20	27	V	
		P		I _D = -250 μA	-8.0	-10.5		
Drain-to-Source Breakdown Voltage Temperature Coefficient	V _{(BR)DSS} / T _J	N				22	mV/°C	
		P						-6.0
Zero Gate Voltage Drain Current	I _{DSS}	N	V _{GS} = 0 V, V _{DS} = 16 V	T _J = 25 °C			1.0	μA
		P	V _{GS} = 0 V, V _{DS} = -6.4 V				1.0	
Gate-to-Source Leakage Current	I _{GSS}	N	V _{DS} = 0 V	V _{GS} = ±12 V			10	μA
		P			V _{GS} = ±8.0			

ON CHARACTERISTICS (Note 2)

Gate Threshold Voltage	V _{GS(TH)}	N	V _{GS} = V _{DS}	I _D = 250 μA	0.6	0.92	1.5	V
		P		I _D = -250 μA	-0.45	-0.83	-1.0	
Gate Threshold Temperature Coefficient	V _{GS(TH)} / T _J	N				-2.1		-mV/°C
		P					2.2	
Drain-to-Source On Resistance	R _{DS(on)}	N	V _{GS} = 4.5 V, I _D = 0.63 A			0.29	0.375	Ω
		P	V _{GS} = -4.5 V, I _D = -0.57 A			0.22	0.30	
		N	V _{GS} = 2.5 V, I _D = 0.40 A			0.36	0.445	
		P	V _{GS} = -2.5 V, I _D = -0.48 A			0.32	0.46	
		P	V _{GS} = -1.8 V, I _D = -0.20 A			0.51	0.90	
Forward Transconductance	g _{FS}	N	V _{DS} = 4.0 V, I _D = 0.63 A			2.0		S
		P	V _{DS} = -4.0 V, I _D = -0.57 A			2.0		

CHARGES AND CAPACITANCES

Input Capacitance	C _{ISS}	N	f = 1 MHz, V _{GS} = 0 V	V _{DS} = 20 V		33	46	pF		
		P		V _{DS} = -8.0V		160	225			
Output Capacitance	C _{OSS}	N		V _{DS} = 20 V		13	22			
		P		V _{DS} = -8.0 V		38	55			
Reverse Transfer Capacitance	C _{RSS}	N		V _{DS} = 20 V		2.8	5.0			
		P		V _{DS} = -8.0 V		28	40			
Total Gate Charge	Q _{G(TOT)}	N		V _{GS} = 4.5 V, V _{DS} = 10 V, I _D = 0.7 A			1.3		3.0	nC
		P		V _{GS} = -4.5 V, V _{DS} = -5.0 V, I _D = -0.6 A			2.2		4.0	
Threshold Gate Charge	Q _{G(TH)}	N		V _{GS} = 4.5 V, V _{DS} = 10 V, I _D = 0.7 A			0.1			
		P		V _{GS} = -4.5 V, V _{DS} = -5.0 V, I _D = -0.6 A			0.1			
Gate-to-Source Charge	Q _{GS}	N	V _{GS} = 4.5 V, V _{DS} = 10 V, I _D = 0.7 A			0.2				
		P	V _{GS} = -4.5 V, V _{DS} = -5.0 V, I _D = -0.6 A			0.5				
Gate-to-Drain Charge	Q _{GD}	N	V _{GS} = 4.5 V, V _{DS} = 10 V, I _D = 0.7 A			0.4				
		P	V _{GS} = -4.5 V, V _{DS} = -5.0 V, I _D = -0.6 A			0.5				

SWITCHING CHARACTERISTICS (Note 3)

Turn-On Delay Time	t _{d(ON)}	N	V _{GS} = 4.5 V, V _{DD} = 10 V, I _D = 0.5 A, R _G = 20 Ω			0.083		μs
Rise Time	t _r					0.227		
Turn-Off Delay Time	t _{d(OFF)}					0.786		
Fall Time	t _f					0.506		
Turn-On Delay Time	t _{d(ON)}	P	V _{GS} = -4.5 V, V _{DD} = -4.0 V, I _D = -0.5 A, R _G = 8.0 Ω			0.013		
Rise Time	t _r					0.023		
Turn-Off Delay Time	t _{d(OFF)}					0.050		
Fall Time	t _f					0.036		

DRAIN-SOURCE DIODE CHARACTERISTICS

Forward Diode Voltage	V _{SD}	N	V _{GS} = 0 V, T _J = 25°C	I _S = 0.23 A		0.76	1.1	V
		P		I _S = -0.23 A		0.76	1.1	
		N	V _{GS} = 0 V, T _J = 125°C	I _S = 0.23 A		0.63		
		P		I _S = -0.23 A		0.63		
Reverse Recovery Time	t _{RR}	N	V _{GS} = 0 V, d _{IS} /d _t = 90 A/μs	I _S = 0.23 A		0.410		μs
		P		I _S = -0.23 A		0.078		

2. Pulse Test: pulse width ≤ 300 μs, duty cycle ≤ 2%.

3. Switching characteristics are independent of operating junction temperatures.

NTJD4105C

TYPICAL N-CHANNEL PERFORMANCE CURVES ($T_J = 25^\circ\text{C}$ unless otherwise noted)

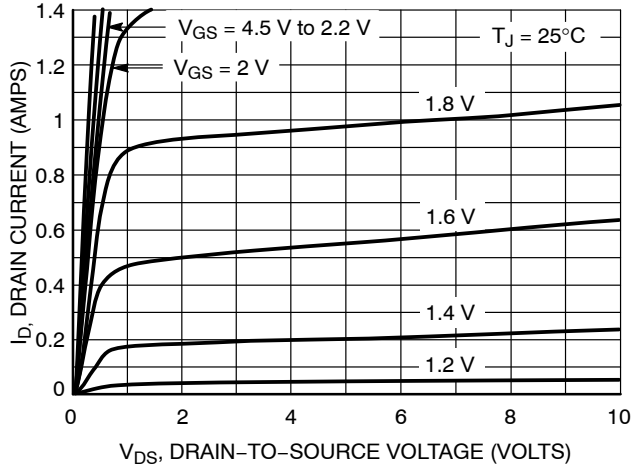

Figure 1. On-Region Characteristics

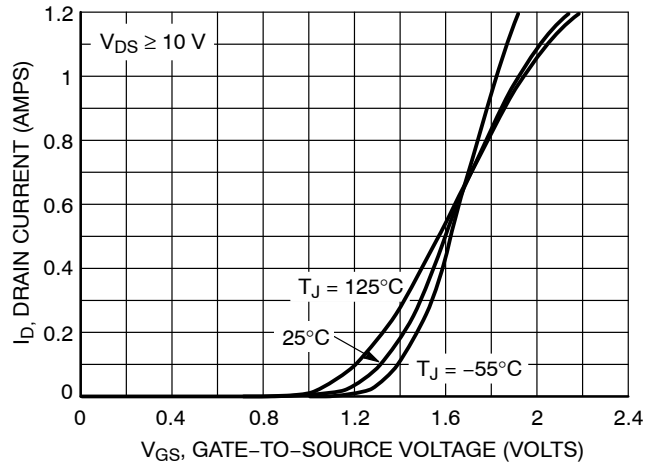

Figure 2. Transfer Characteristics

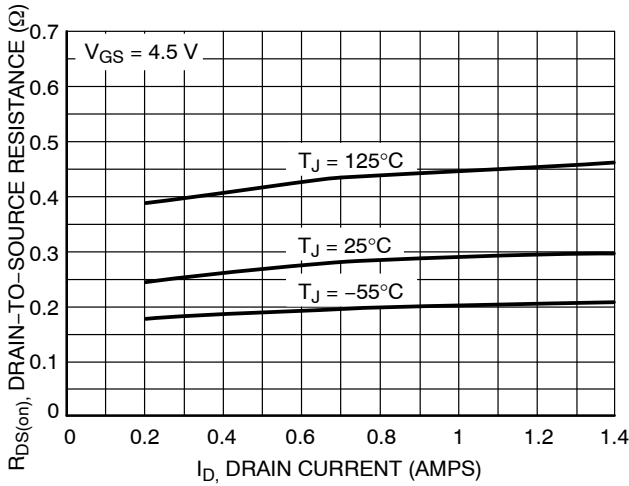

Figure 3. On-Resistance vs. Drain Current and Temperature

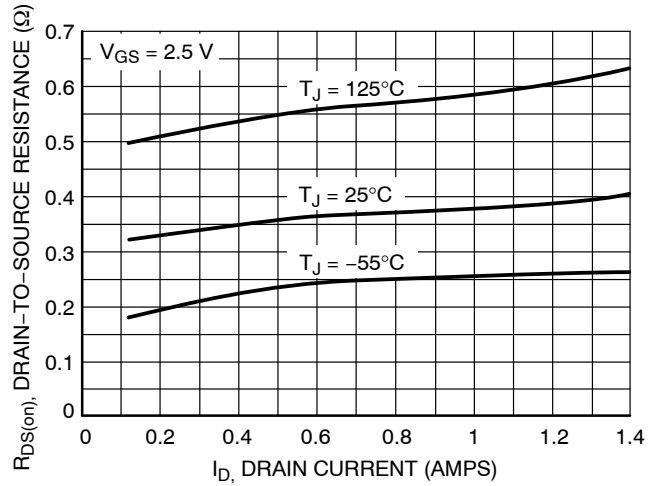

Figure 4. On-Resistance vs. Drain Current and Temperature

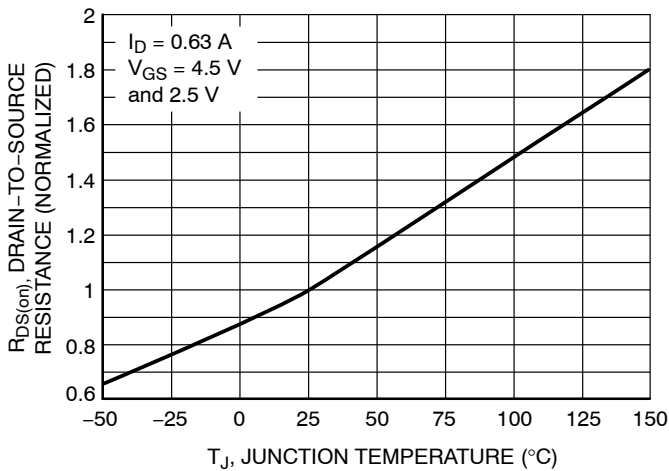

Figure 5. On-Resistance Variation with Temperature

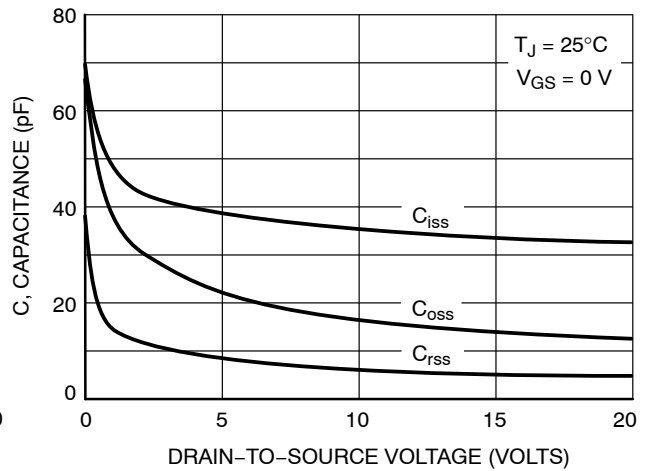

Figure 6. Capacitance Variation

NTJD4105C

TYPICAL N-CHANNEL PERFORMANCE CURVES ($T_J = 25^\circ\text{C}$ unless otherwise noted)

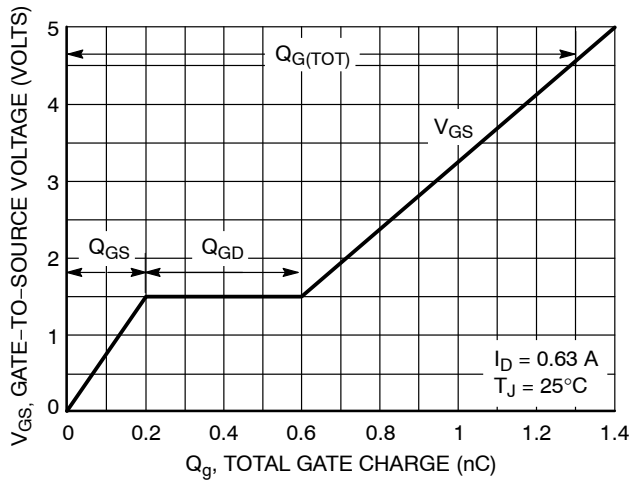

Figure 7. Gate-to-Source and Drain-to-Source Voltage vs. Total Charge

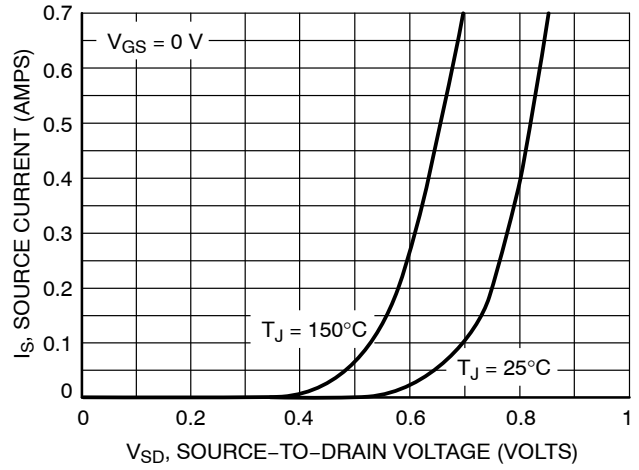

Figure 8. Diode Forward Voltage vs. Current

NTJD4105C

TYPICAL P-CHANNEL PERFORMANCE CURVES ($T_J = 25^\circ\text{C}$ unless otherwise noted)

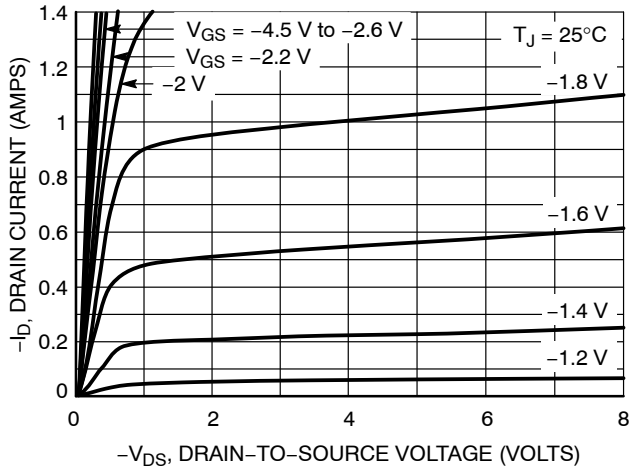

Figure 9. On-Region Characteristics

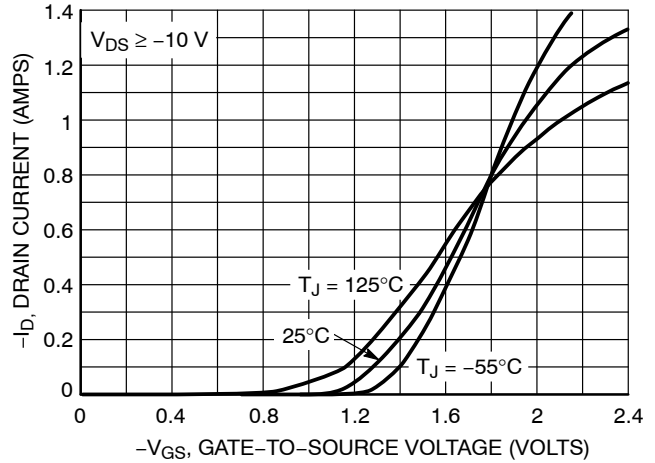

Figure 10. Transfer Characteristics

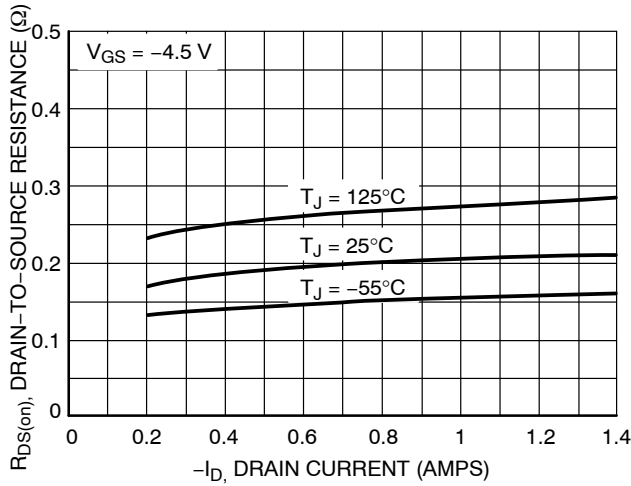

Figure 11. On-Resistance vs. Drain Current and Temperature

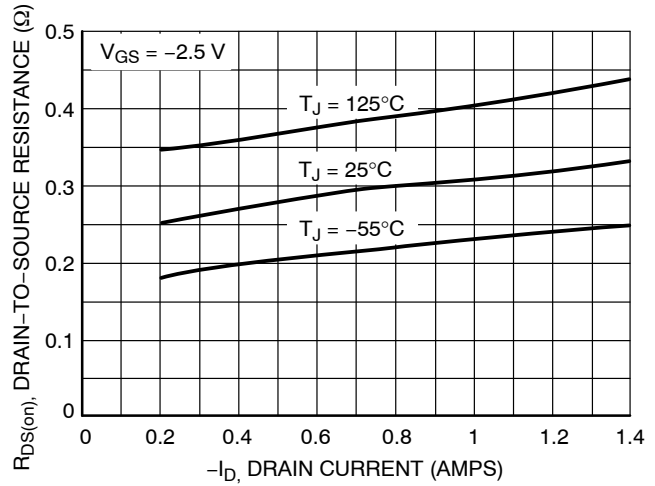

Figure 12. On-Resistance vs. Drain Current and Temperature

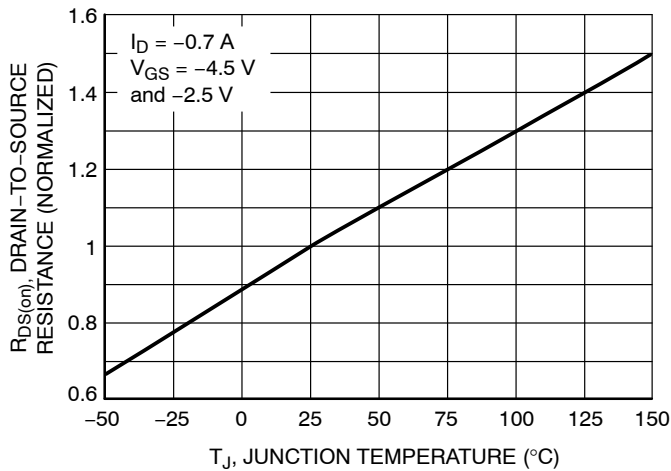

Figure 13. On-Resistance Variation with Temperature

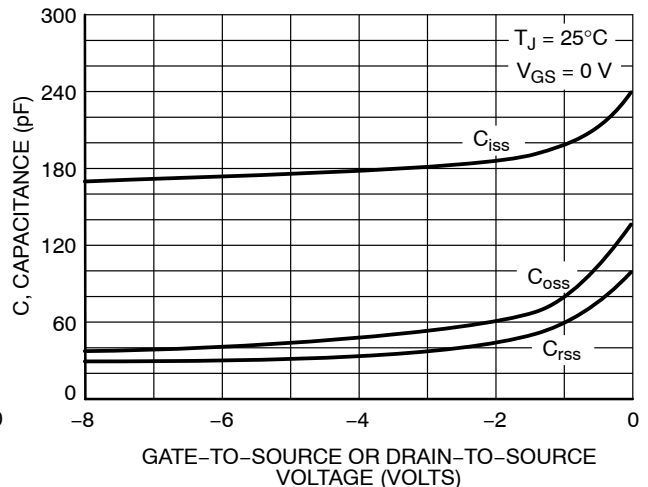

Figure 14. Capacitance Variation

NTJD4105C

TYPICAL P-CHANNEL PERFORMANCE CURVES ($T_J = 25^\circ\text{C}$ unless otherwise noted)

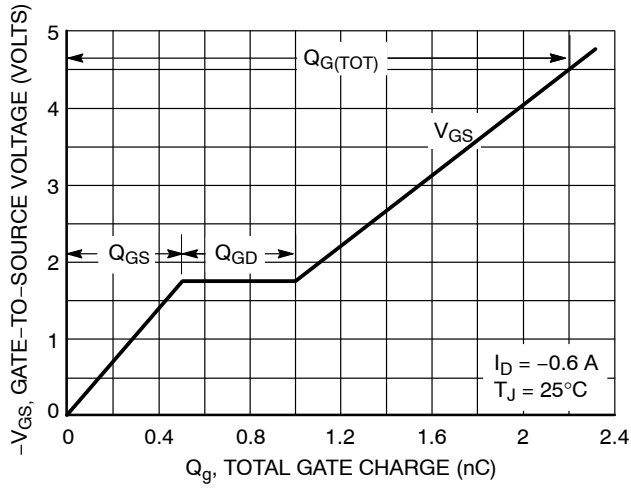

Figure 15. Gate-to-Source and Drain-to-Source Voltage vs. Total Charge

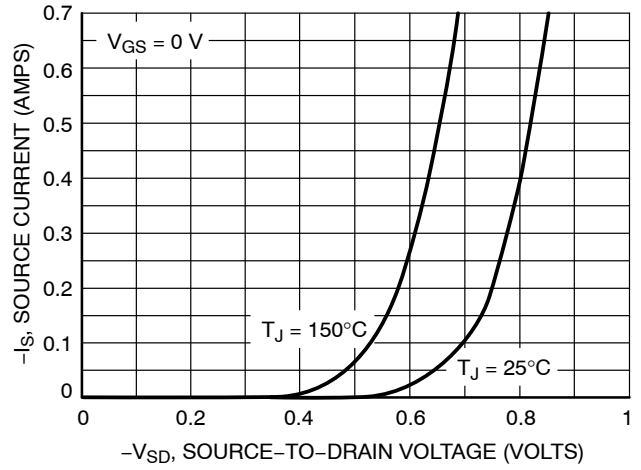

Figure 16. Diode Forward Voltage vs. Current

NTJD4105C

ORDERING INFORMATION

Device	Package	Shipping [†]
NTJD4105CT1	SOT-363	3000 / Tape & Reel
NTJD4105CT1G	SOT-363 (Pb-Free)	3000 / Tape & Reel
NTJD4105CT2	SOT-363	3000 / Tape & Reel
NTJD4105CT2G	SOT-363 (Pb-Free)	3000 / Tape & Reel
NTJD4105CT4	SOT-363	10,000 / Tape & Reel
NTJD4105CT4G	SOT-363 (Pb-Free)	10,000 / Tape & Reel

[†]For information on tape and reel specifications, including part orientation and tape sizes, please refer to our Tape and Reel Packaging Specifications Brochure, BRD8011/D.



1
 SCALE 2:1

SC-88/SC70-6/SOT-363
 CASE 419B-02
 ISSUE Y

DATE 11 DEC 2012

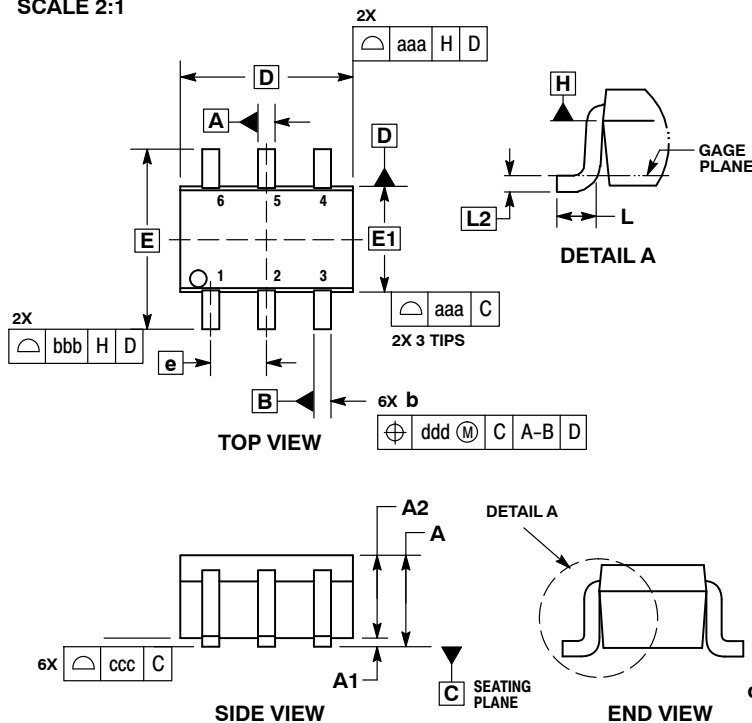

- NOTES:
1. DIMENSIONING AND TOLERANCING PER ASME Y14.5M, 1994.
 2. CONTROLLING DIMENSION: MILLIMETERS.
 3. DIMENSIONS D AND E1 DO NOT INCLUDE MOLD FLASH, PROTRUSIONS, OR GATE BURRS. MOLD FLASH, PROTRUSIONS, OR GATE BURRS SHALL NOT EXCEED 0.20 PER END.
 4. DIMENSIONS D AND E1 AT THE OUTERMOST EXTREMES OF THE PLASTIC BODY AND DATUM H.
 5. DATUMS A AND B ARE DETERMINED AT DATUM H.
 6. DIMENSIONS b AND c APPLY TO THE FLAT SECTION OF THE LEAD BETWEEN 0.08 AND 0.15 FROM THE TIP.
 7. DIMENSION b DOES NOT INCLUDE DAMBAR PROTRUSION. ALLOWABLE DAMBAR PROTRUSION SHALL BE 0.08 TOTAL IN EXCESS OF DIMENSION b AT MAXIMUM MATERIAL CONDITION. THE DAMBAR CANNOT BE LOCATED ON THE LOWER RADIUS OF THE FOOT.

DIM	MILLIMETERS			INCHES		
	MIN	NOM	MAX	MIN	NOM	MAX
A	---	---	1.10	---	---	0.043
A1	0.00	---	0.10	0.000	---	0.004
A2	0.70	0.90	1.00	0.027	0.035	0.039
b	0.15	0.20	0.25	0.006	0.008	0.010
C	0.08	0.15	0.22	0.003	0.006	0.009
D	1.80	2.00	2.20	0.070	0.078	0.086
E	2.00	2.10	2.20	0.078	0.082	0.086
E1	1.15	1.25	1.35	0.045	0.049	0.053
e	0.65 BSC			0.026 BSC		
L	0.26	0.36	0.46	0.010	0.014	0.018
L2	0.15 BSC			0.006 BSC		
aaa	0.15			0.006		
bbb	0.30			0.012		
ccc	0.10			0.004		
ddd	0.10			0.004		

GENERIC MARKING DIAGRAM*

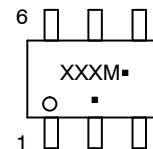

- XXX = Specific Device Code
- M = Date Code*
- = Pb-Free Package

(Note: Microdot may be in either location)

*Date Code orientation and/or position may vary depending upon manufacturing location.

*This information is generic. Please refer to device data sheet for actual part marking. Pb-Free indicator, "G" or microdot "▪", may or may not be present. Some products may not follow the Generic Marking.

RECOMMENDED SOLDERING FOOTPRINT*

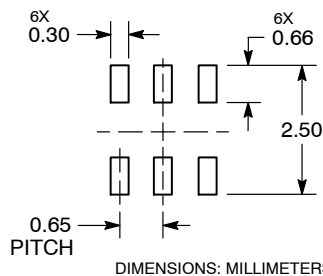

*For additional information on our Pb-Free strategy and soldering details, please download the ON Semiconductor Soldering and Mounting Techniques Reference Manual, SOLDERRM/D.

STYLES ON PAGE 2

DOCUMENT NUMBER:	98ASB42985B	Electronic versions are uncontrolled except when accessed directly from the Document Repository. Printed versions are uncontrolled except when stamped "CONTROLLED COPY" in red.
DESCRIPTION:	SC-88/SC70-6/SOT-363	PAGE 1 OF 2

ON Semiconductor and ON are trademarks of Semiconductor Components Industries, LLC dba ON Semiconductor or its subsidiaries in the United States and/or other countries. ON Semiconductor reserves the right to make changes without further notice to any products herein. ON Semiconductor makes no warranty, representation or guarantee regarding the suitability of its products for any particular purpose, nor does ON Semiconductor assume any liability arising out of the application or use of any product or circuit, and specifically disclaims any and all liability, including without limitation special, consequential or incidental damages. ON Semiconductor does not convey any license under its patent rights nor the rights of others.

SC-88/SC70-6/SOT-363
CASE 419B-02
ISSUE Y

DATE 11 DEC 2012

STYLE 1: PIN 1. EMITTER 2 2. BASE 2 3. COLLECTOR 1 4. EMITTER 1 5. BASE 1 6. COLLECTOR 2	STYLE 2: CANCELLED	STYLE 3: CANCELLED	STYLE 4: PIN 1. CATHODE 2. CATHODE 3. COLLECTOR 4. EMITTER 5. BASE 6. ANODE	STYLE 5: PIN 1. ANODE 2. ANODE 3. COLLECTOR 4. EMITTER 5. BASE 6. CATHODE	STYLE 6: PIN 1. ANODE 2 2. N/C 3. CATHODE 1 4. ANODE 1 5. N/C 6. CATHODE 2
STYLE 7: PIN 1. SOURCE 2 2. DRAIN 2 3. GATE 1 4. SOURCE 1 5. DRAIN 1 6. GATE 2	STYLE 8: CANCELLED	STYLE 9: PIN 1. EMITTER 2 2. EMITTER 1 3. COLLECTOR 1 4. BASE 1 5. BASE 2 6. COLLECTOR 2	STYLE 10: PIN 1. SOURCE 2 2. SOURCE 1 3. GATE 1 4. DRAIN 1 5. DRAIN 2 6. GATE 2	STYLE 11: PIN 1. CATHODE 2 2. CATHODE 2 3. ANODE 1 4. CATHODE 1 5. CATHODE 1 6. ANODE 2	STYLE 12: PIN 1. ANODE 2 2. ANODE 2 3. CATHODE 1 4. ANODE 1 5. ANODE 1 6. CATHODE 2
STYLE 13: PIN 1. ANODE 2. N/C 3. COLLECTOR 4. EMITTER 5. BASE 6. CATHODE	STYLE 14: PIN 1. VREF 2. GND 3. GND 4. IOUT 5. VEN 6. VCC	STYLE 15: PIN 1. ANODE 1 2. ANODE 2 3. ANODE 3 4. CATHODE 3 5. CATHODE 2 6. CATHODE 1	STYLE 16: PIN 1. BASE 1 2. EMITTER 2 3. COLLECTOR 2 4. BASE 2 5. EMITTER 1 6. COLLECTOR 1	STYLE 17: PIN 1. BASE 1 2. EMITTER 1 3. COLLECTOR 2 4. BASE 2 5. EMITTER 2 6. COLLECTOR 1	STYLE 18: PIN 1. VIN1 2. VCC 3. VOUT2 4. VIN2 5. GND 6. VOUT1
STYLE 19: PIN 1. IOUT 2. GND 3. GND 4. V CC 5. V EN 6. V REF	STYLE 20: PIN 1. COLLECTOR 2. COLLECTOR 3. BASE 4. EMITTER 5. COLLECTOR 6. COLLECTOR	STYLE 21: PIN 1. ANODE 1 2. N/C 3. ANODE 2 4. CATHODE 2 5. N/C 6. CATHODE 1	STYLE 22: PIN 1. D1 (i) 2. GND 3. D2 (i) 4. D2 (c) 5. VBUS 6. D1 (c)	STYLE 23: PIN 1. Vn 2. CH1 3. Vp 4. N/C 5. CH2 6. N/C	STYLE 24: PIN 1. CATHODE 2. ANODE 3. CATHODE 4. CATHODE 5. CATHODE 6. CATHODE
STYLE 25: PIN 1. BASE 1 2. CATHODE 3. COLLECTOR 2 4. BASE 2 5. EMITTER 6. COLLECTOR 1	STYLE 26: PIN 1. SOURCE 1 2. GATE 1 3. DRAIN 2 4. SOURCE 2 5. GATE 2 6. DRAIN 1	STYLE 27: PIN 1. BASE 2 2. BASE 1 3. COLLECTOR 1 4. EMITTER 1 5. EMITTER 2 6. COLLECTOR 2	STYLE 28: PIN 1. DRAIN 2. DRAIN 3. GATE 4. SOURCE 5. DRAIN 6. DRAIN	STYLE 29: PIN 1. ANODE 2. ANODE 3. COLLECTOR 4. EMITTER 5. BASE/ANODE 6. CATHODE	STYLE 30: PIN 1. SOURCE 1 2. DRAIN 2 3. DRAIN 2 4. SOURCE 2 5. GATE 1 6. DRAIN 1

Note: Please refer to datasheet for style callout. If style type is not called out in the datasheet refer to the device datasheet pinout or pin assignment.

DOCUMENT NUMBER:	98ASB42985B	Electronic versions are uncontrolled except when accessed directly from the Document Repository. Printed versions are uncontrolled except when stamped "CONTROLLED COPY" in red.
DESCRIPTION:	SC-88/SC70-6/SOT-363	PAGE 2 OF 2

ON Semiconductor and  are trademarks of Semiconductor Components Industries, LLC dba ON Semiconductor or its subsidiaries in the United States and/or other countries. ON Semiconductor reserves the right to make changes without further notice to any products herein. ON Semiconductor makes no warranty, representation or guarantee regarding the suitability of its products for any particular purpose, nor does ON Semiconductor assume any liability arising out of the application or use of any product or circuit, and specifically disclaims any and all liability, including without limitation special, consequential or incidental damages. ON Semiconductor does not convey any license under its patent rights nor the rights of others.

onsemi, **Onsemi**, and other names, marks, and brands are registered and/or common law trademarks of Semiconductor Components Industries, LLC dba "**onsemi**" or its affiliates and/or subsidiaries in the United States and/or other countries. **onsemi** owns the rights to a number of patents, trademarks, copyrights, trade secrets, and other intellectual property. A listing of **onsemi**'s product/patent coverage may be accessed at www.onsemi.com/site/pdf/Patent-Marking.pdf. **onsemi** reserves the right to make changes at any time to any products or information herein, without notice. The information herein is provided "as-is" and **onsemi** makes no warranty, representation or guarantee regarding the accuracy of the information, product features, availability, functionality, or suitability of its products for any particular purpose, nor does **onsemi** assume any liability arising out of the application or use of any product or circuit, and specifically disclaims any and all liability, including without limitation special, consequential or incidental damages. Buyer is responsible for its products and applications using **onsemi** products, including compliance with all laws, regulations and safety requirements or standards, regardless of any support or applications information provided by **onsemi**. "Typical" parameters which may be provided in **onsemi** data sheets and/or specifications can and do vary in different applications and actual performance may vary over time. All operating parameters, including "Typicals" must be validated for each customer application by customer's technical experts. **onsemi** does not convey any license under any of its intellectual property rights nor the rights of others. **onsemi** products are not designed, intended, or authorized for use as a critical component in life support systems or any FDA Class 3 medical devices or medical devices with a same or similar classification in a foreign jurisdiction or any devices intended for implantation in the human body. Should Buyer purchase or use **onsemi** products for any such unintended or unauthorized application, Buyer shall indemnify and hold **onsemi** and its officers, employees, subsidiaries, affiliates, and distributors harmless against all claims, costs, damages, and expenses, and reasonable attorney fees arising out of, directly or indirectly, any claim of personal injury or death associated with such unintended or unauthorized use, even if such claim alleges that **onsemi** was negligent regarding the design or manufacture of the part. **onsemi** is an Equal Opportunity/Affirmative Action Employer. This literature is subject to all applicable copyright laws and is not for resale in any manner.

PUBLICATION ORDERING INFORMATION

LITERATURE FULFILLMENT:

Email Requests to: orderlit@onsemi.com

onsemi Website: www.onsemi.com

TECHNICAL SUPPORT

North American Technical Support:

Voice Mail: 1 800-282-9855 Toll Free USA/Canada

Phone: 011 421 33 790 2910

Europe, Middle East and Africa Technical Support:

Phone: 00421 33 790 2910

For additional information, please contact your local Sales Representative

Mouser Electronics

Authorized Distributor

Click to View Pricing, Inventory, Delivery & Lifecycle Information:

[onsemi:](#)

[NTJD4105CT1G](#) [NTJD4105CT2G](#)