

## N-Channel MOSFET MEM2310XG-N

### General Description

MEM2310XG-N Series N-channel enhancement mode field-effect transistor, These miniature surface mount MOSFETs utilize High Cell Density process. Low RDS(ON) assures minimal power loss and conserves energy, making this device ideal for use in power management circuitry. Typical applications are DC-DC converters, power management in portable and battery-powered products such as computers, printers, battery charger, telecommunication power system, and telephones power system.

### Features

- 30V/4.4A  
RDS(ON), Vgs@10V, Ids@4.4A = 35mΩ  
RDS(ON), Vgs@4.5V, Ids@2.8A = 51mΩ
- High Density Cell Design For Ultra Low On-Resistance
- High power and current handling capability
- Low side high current DC-DC Converter applications
- Subminiature surface mount package:SOT23

### Pin Configuration

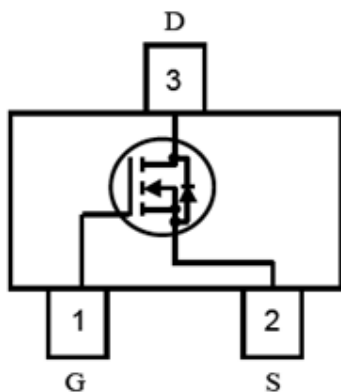

### Typical Application

- Battery management
- High speed switch
- Low power DC to DC converter

### Absolute Maximum Ratings (TA = 25°C unless otherwise noted)

Parameter	Symbol	Ratings	Unit
Drain-Source Voltage	V <sub>DSS</sub>	30V	V
Gate-Source Voltage	V <sub>GSS</sub>	±20	V
Drain Current	I <sub>D</sub>	4.4	A
Pulsed Drain Current <sup>1,2</sup>	I <sub>DM</sub>	17.6	A
Total Power Dissipation	P <sub>d</sub>	1.25	W
operating junction temperature	T <sub>j</sub>	-55~150	°C
Storage Temperature Range	T <sub>stg</sub>	-55~150	°C

### Thermal Characteristics

Parameter	Symbol	TYP.	MAX.	Unit
Junction-to-Ambient Thermal resistance	RθJA	100		°C/W

## Electrical Characteristics

Parameter	Symbol	Test Condition	Min	Type	Max	Unit
<b>Static Characteristics</b>						
Drain-Source Breakdown Voltage	$V_{(BR)DSS}$	$V_{GS}=0V, I_D=250\mu A$	30	-	-	V
Gate Threshold Voltage	$V_{GS(th)}$	$V_{DS}=V_{GS}, I_D=250\mu A$	1	1.37	2.1	V
Gate-Body Leakage	$I_{GSS}$	$V_{DS}=0V, V_{GS}=20V$	-	-	100	nA
		$V_{DS}=0V, V_{GS}=-20V$	-	-	-100	nA
Zero Gate Voltage Drain Current	$I_{DSS}$	$V_{DS}=30V, V_{GS}=0V$ $T_J=25^\circ C$	-	-	1	nA
		$V_{DS}=24V, V_{GS}=0V$ $T_J=55^\circ C$	-	-	10	nA
Static Drain-Source On-Resistance	$R_{DS(ON)}$	$V_{GS}=10V, I_D=4.4A$	-	35	48	m $\Omega$
		$V_{GS}=4.5V, I_D=2.8A$	-	51	70	m $\Omega$
Max. Diode Forward Current	$I_S$		-	-	1.7	A
Source-drain (diode forward) voltage	$V_{SD}$	$V_{GS}=0V, I_S=1.7A$	-	0.78	1.2	V
<b>Dynamic Characteristics</b>						
Input Capacitance	$C_{iss}$	$V_{DS} = 15 V,$ $V_{GS} = 0 V,$ $f = 1 MHz$	-	235	-	pF
Output Capacitance	$C_{oss}$		-	36	-	
Reverse Transfer Capacitance	$C_{rss}$		-	24	-	
<b>Switching Characteristics</b>						
Turn-On Delay Time	$t_{d(on)}$	$V_{DS} = 15 V,$ $V_{GS} = 10 V,$ $R_g = 6 \Omega,$ $I_D = 4.4 A$	-	3	-	ns
Rise Time	$t_r$		-	39	-	
Turn-Off Delay Time	$t_{d(off)}$		-	23	-	
Fall-Time	$t_f$		-	28	-	
Total Gate Charge	$Q_g$	$V_{DS} = 15 V,$ $V_{GS} = 10 V,$ $I_D = 4.4 A$	-	5.8	-	nC
Gate-Source Charge	$Q_{gs}$		-	1.0	-	
Gate-Drain Charge	$Q_{gd}$		-	1.0	-	

1、Repetitive rating, pulse width limited by junction temperature.

2、Pulse width <300 $\mu s$  , duty cycle <0.5%.

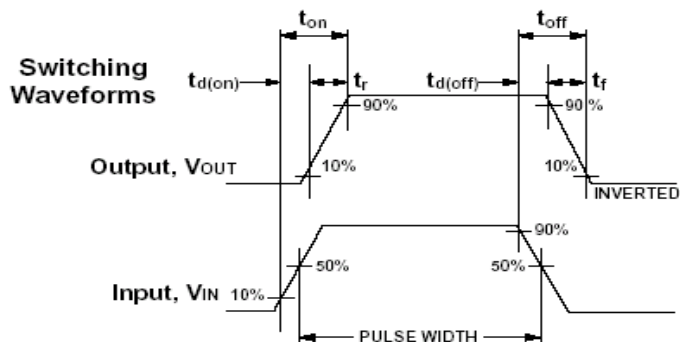
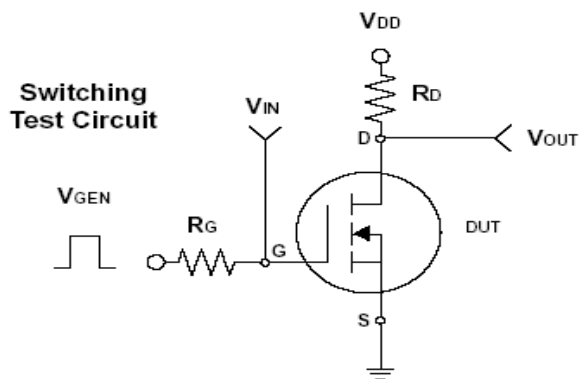

## Typical Performance Characteristics

### On-state Characteristics

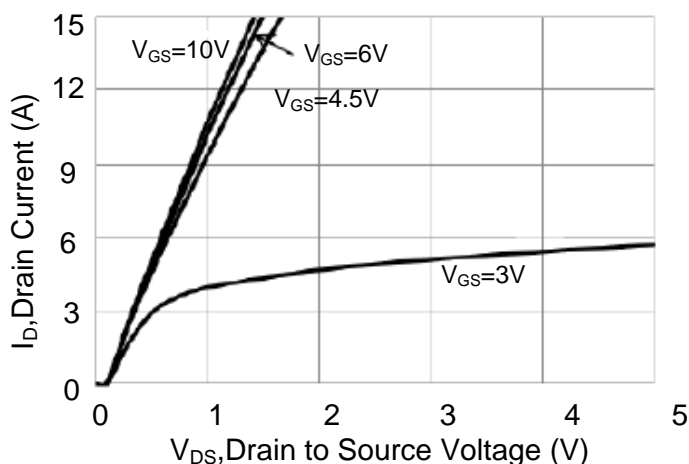

### Transfer Characteristics

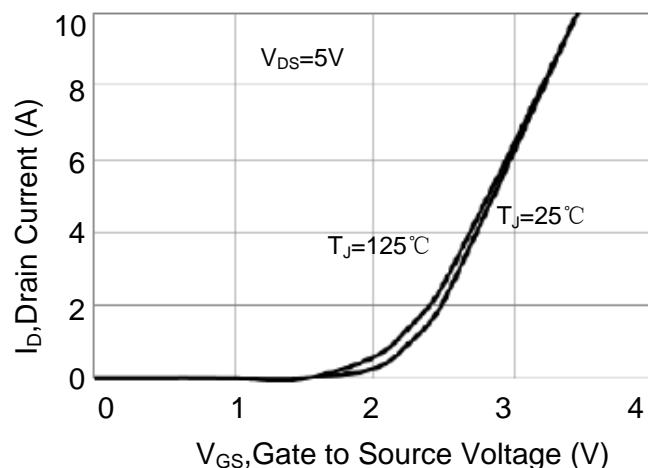

### On-Resistance vs. Drain Current

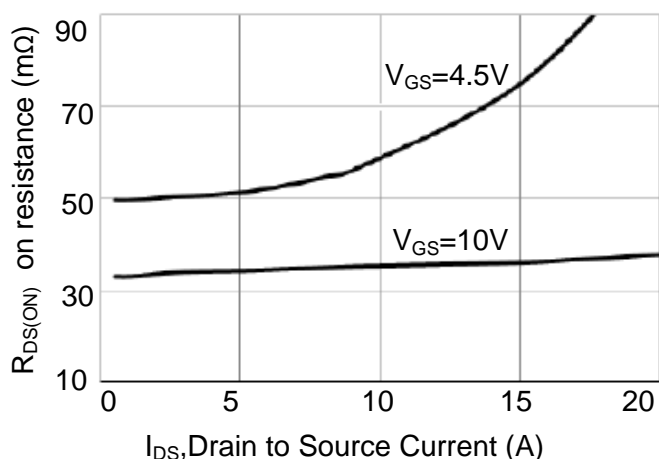

### Normalized On-Resistance vs. $T_J$

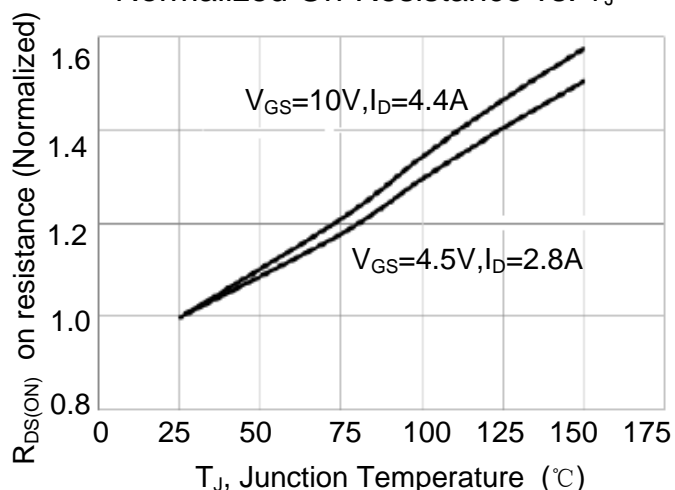

### On-Resistance Variation vs. $V_{GS}$

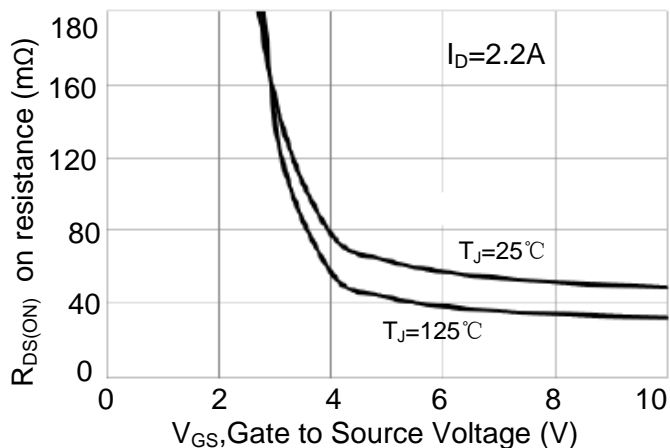

### Body Diode Characteristics

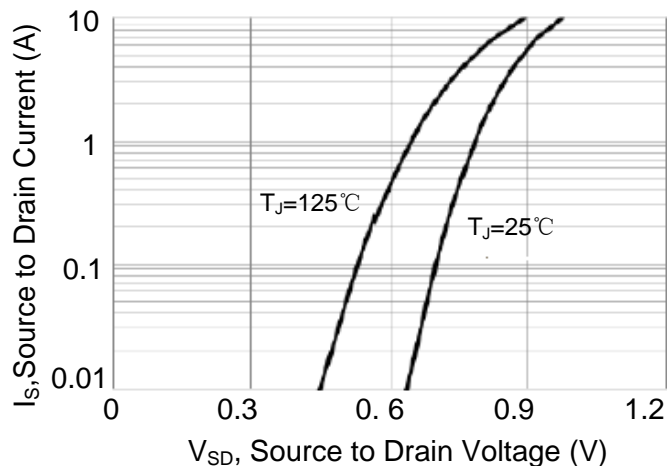

### Gate Charge Characteristics

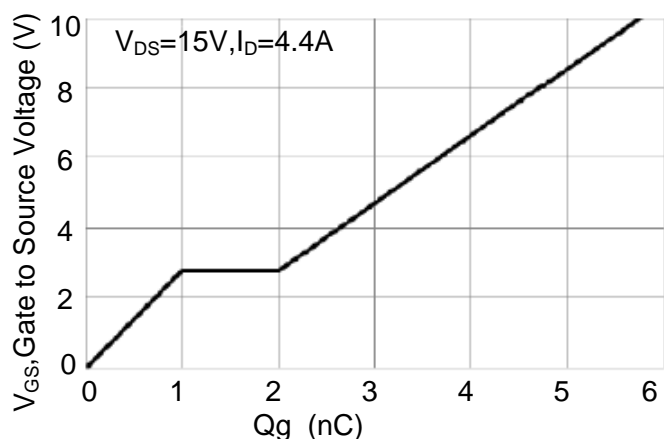

### Threshold Voltage Variation with Temperature

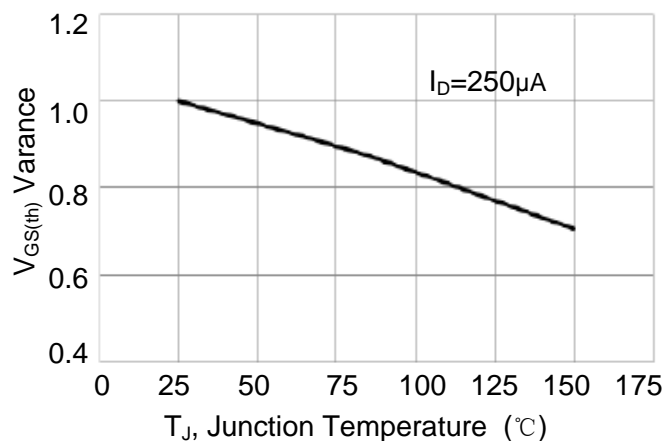

### Capacitance vs. Drain-Source Voltage

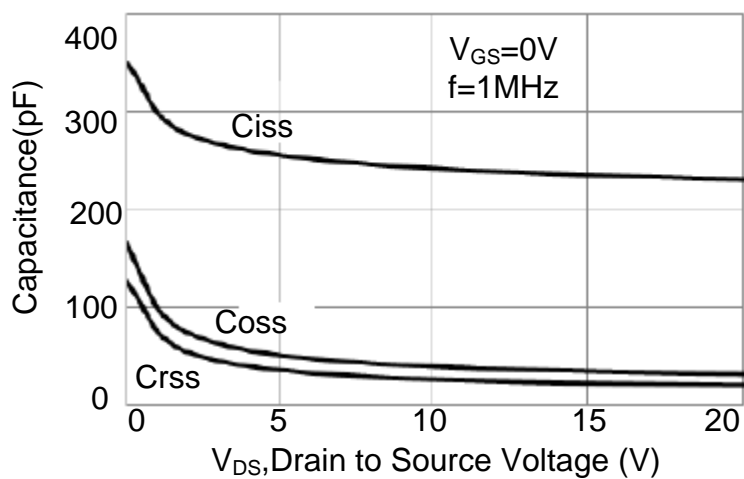

## Package Information

Package Type:SOT23 Unit:mm(inch)

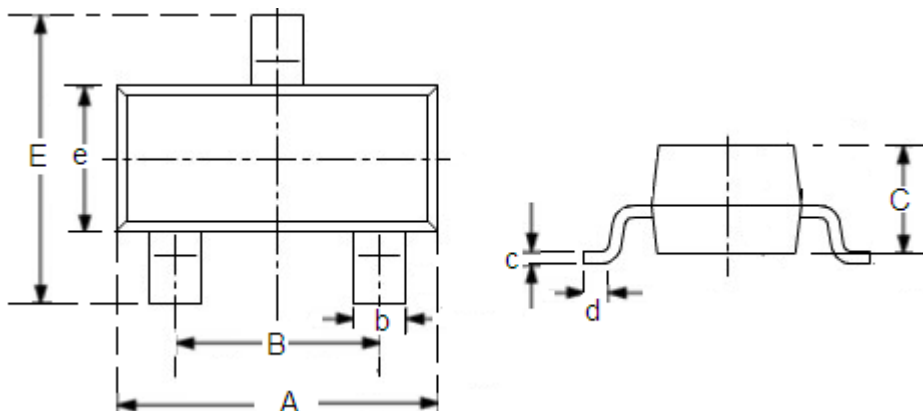

DIM	Millimeters		Inches	
	Min	Max	Min	Max
A	2.7	3.1	0.1063	0.122
B	1.7	2.1	0.0669	0.0827
b	0.35	0.5	0.0138	0.0197
C	1.0	1.2	0.0394	0.0472
c	0.1	0.25	0.0039	0.0098
d	0.2	-	0.0079	-
E	2.1	2.64	0.0827	0.1039
e	1.2	1.4	0.0472	0.0551

- The information described herein is subject to change without notice.
- Nanjing Micro One Electronics Inc is not responsible for any problems caused by circuits or diagrams described herein whose related industrial properties, patents, or other rights belong to third parties. The application circuit examples explain typical applications of the products, and do not guarantee the success of any specific mass-production design.
- Use of the information described herein for other purposes and/or reproduction or copying without the express permission of Nanjing Micro One Electronics Inc is strictly prohibited.
- The products described herein cannot be used as part of any device or equipment affecting the human body, such as exercise equipment, medical equipment, security systems, gas equipment, or any apparatus installed in airplanes and other vehicles, without prior written permission of Nanjing Micro One Electronics Inc.
- Although Nanjing Micro One Electronics Inc exerts the greatest possible effort to ensure high quality and reliability, the failure or malfunction of semiconductor products may occur. The user of these products should therefore give thorough consideration to safety design, including redundancy, fire-prevention measures, and malfunction prevention, to prevent any accidents, fires, or community damage that may ensue.