

# IS series

Sealed pushbutton switches •  
threaded bushing Ø 12 mm • momentary



## DISTINCTIVE FEATURES

Threaded bushing models

Compact, lightweight

Tactile feedback

Sealed to IP67



## ENVIRONMENTAL SPECIFICATIONS

- Front panel sealing according to IEC 60529 : IP67
- Shock resistance : 100 g according to IEC 512-4, test 6c
- Vibration resistance : 10-500 Hz - 10 g according to IEC 512-4, test 6d
- Salt spray : IEC 512-6, test 11f
- Operating temperature : -40 °C to +85 °C (-40 °F to +185 °F)



## ELECTRICAL SPECIFICATIONS

- Max. current/voltage rating with resistive load :  
400 mA 32 VAC - 100 mA 48 VDC
- Initial contact resistance : 50 mΩ max.
- Insulation resistance : 1 GΩ min. at 500 VDC
- Dielectric strength : 1,000 Vrms
- Electrical life at full load : 500,000 cycles



## GENERAL SPECIFICATIONS

- Panel thickness : 1.5 mm (.059) min. - 4 mm (.157) max.
- Total travel : 1.7 mm (.066) ± 0,3 mm
- Typical operating force : 4 N ± 3 N
- Low level or mechanical life : 1,000,000 cycles
- Torque (applied to nut) : 1 Nm max. with metal nut U166  
1.5 Nm max. with plastic nut U4248
- Soldering : 300 °C (572 °F) max. for 3 seconds

The company reserves the right to change specifications without notice.

# IS series



Sealed pushbutton switches • threaded bushing Ø 12 mm • momentary



## MATERIALS

- Case : thermoplastic UL94-V0
- Actuator : polyamide 6/6
- Bushing/bezel : polyamide 6/6
- Contacts : silver, gold plated
- Terminal seal : epoxy

APEM products may be recycled at end-of-life for the re-claiming of valuable metal components.

## AGENCY APPROVAL



2 A 125 VAC/250 VAC  
File E83438

**Availability** : consult factory for details of approved models.

**Marking** : to order switches marked UL, complete appropriate box of ordering format.



## TERMINALS

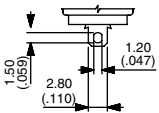

Solder lug S

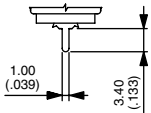

Straight P

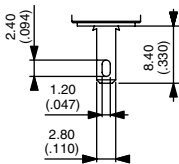

Quick-connect Z



## ELECTRICAL FUNCTIONS

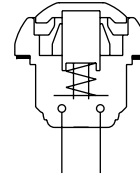

Function 3 (NO)



## MOUNTING STANDARD BEZEL

### PANEL CUT-OUT

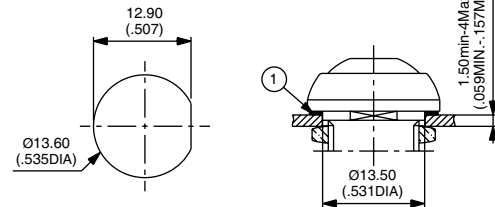

① - Flat seal

### MATRIX MOUNTING

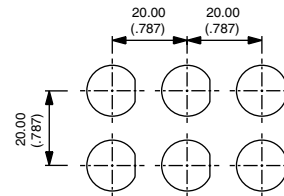

## MOUNTING REDUCED MODEL

### PANEL CUT-OUT

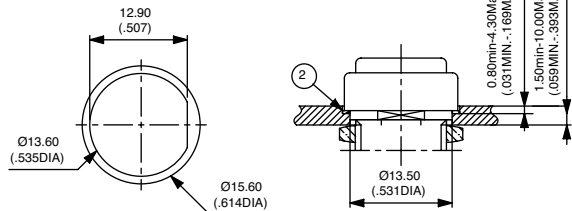

② - O-ring

### MATRIX MOUNTING

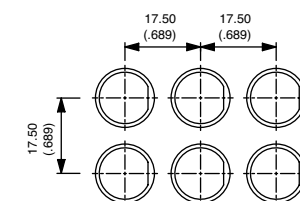

# IS series

Sealed pushbutton switches • threaded bushing Ø 12 mm • momentary



## BUILD YOUR PART NUMBER

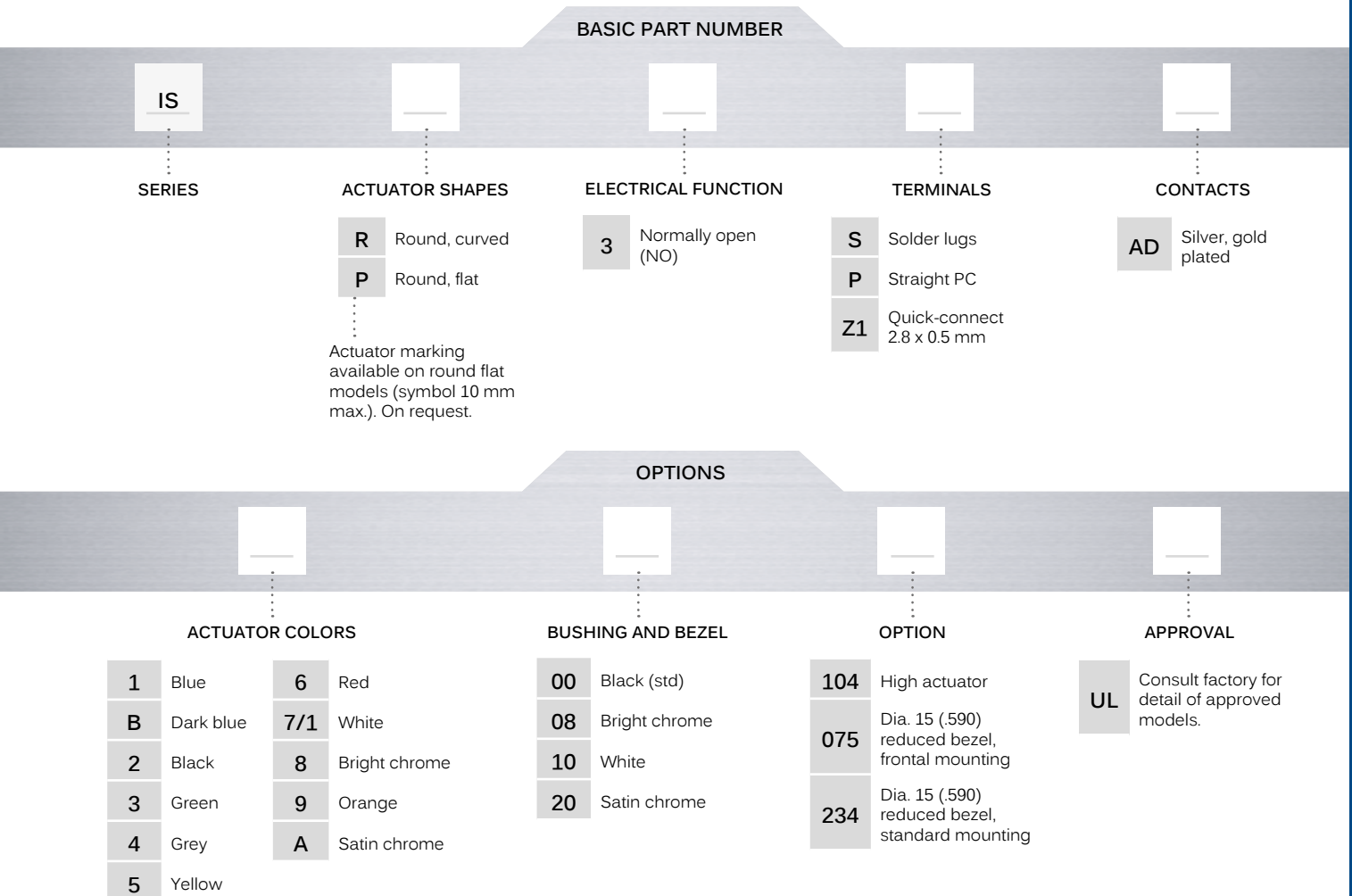

## ABOUT THIS SERIES

On the following pages, you will find successively basic part numbers of switches and options in the same order as in above chart.

- Notice** : please note that not all combinations of above numbers are available. Refer to the following pages for further information.
- A sealing boot** is available to protect the switches against frost and sand (P/N U5125). See "Sealing Boots" section of website.
- Mounting accessories** : Standard hardware supplied : 1 flat seal. Plastic nut 17 mm (.669) across flats, thickness 4 mm (.157) available on request. Part number U4248.



# IS series

Sealed pushbutton switches • threaded bushing Ø 12 mm • momentary

## SOLDER LUG TERMINALS



Curved actuator

**ISR3SAD**



Normally Open

Flat actuator

**ISP3SAD**



Normally Open

Also available with straight PC terminals : **IS•3PAD**  
or quick-connect terminals : **IS•3Z1AD**

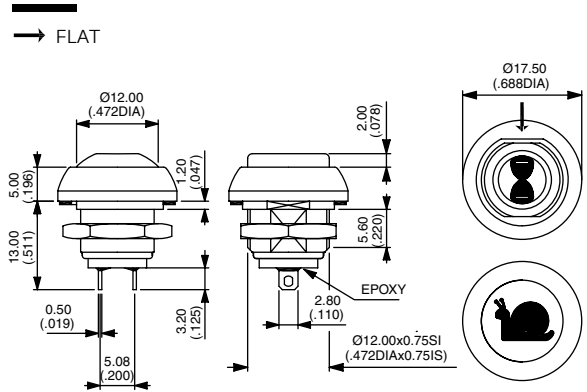

### ACTUATOR COLORS



- 1 Blue
- B Dark blue
- 2 Black
- 3 Green
- 4 Grey
- 5 Yellow
- 6 Red
- 7/1 White
- 8 Bright chrome
- 9 Orange
- A Satin chrome

### BUSHING AND BEZEL



- 00 Black (standard)
- 08 Bright chrome
- 10 White
- 20 Satin chrome



# IS series

Sealed pushbutton switches • threaded bushing  $\varnothing$  12 mm • momentary

### OPTIONS



- 104 High actuator
- 075 Dia. 15 (.590) reduced bezel, mounting of the switch from the front into a threaded panel cut-out
- 234 Dia. 15 (.590) reduced bezel, standard mounting

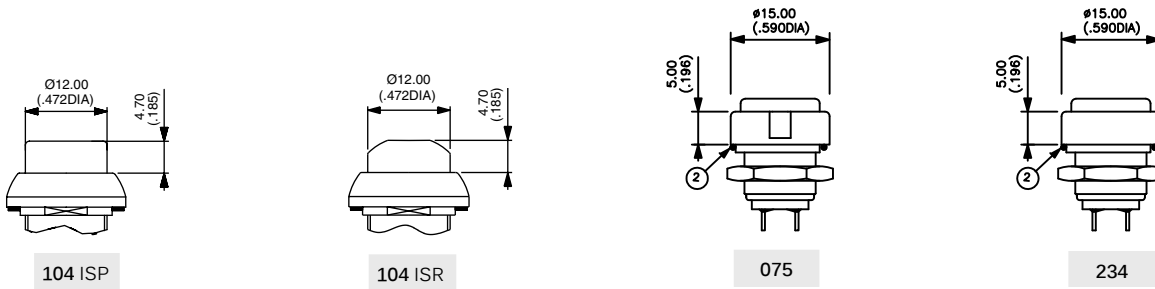

### AGENCY APPROVAL



- UL
- Availability : consult factory for details of approved models.
- Marking : to order switches marked UL, complete appropriate box of ordering format.

### EXAMPLE OF CUSTOM SWITCH



ISR3FADB22X1248-01

- Painted bushing and actuator, soft feel
- Flying leads (55 mm) + connector
- Overmolded rear part