



**Specific Lighting  
Product Data Sheet**  
LTW-Q35ZRGB

Spec No. :DS23-2015-0109  
Effective Date: 11/24/2017  
Revision: A

**LITE-ON DCC**

**RELEASE**

**BNS-OD-FC001/A4**

## Specific Lighting LTW-Q35ZRGB

### 1. Description

The LTW (LiteOn White LED) is a revolutionary, energy efficient and ultra compact new light source, combining the lifetime and reliability advantages of Light Emitting Diodes with the brightness of conventional lighting. It gives you total design freedom and unmatched brightness, creating a new opportunities for solid state lighting to displace conventional lighting technologies...

#### 1.1 Features

- Package in 12mm tape on 7" diameter reels
- Compatible with automatic placement equipment.
- Compatible with infrared and vapor phase reflow solder process.
- EIA STD package.
- I.C. compatible.
- Meet green product and Pb-free(According to RoHS)

#### 1.2 Benefits Features

- Ambient lights (household appliances)
- Portable (flashlight, bicycle)
- Downlighters/Orientation
- Decorative/Entertainment
- Bollards/Security/Garden
- Cove/Undershef/Task
- Traffic signaling/Beacons/ Rail crossing and Wayside
- Indoor/Outdoor Commercial and Residential Architectural
- Edge\_lit signs (Exit, point of sale)

### 2. Outline Dimensions

#### 2.1 Form Factor of Q35ZRGB

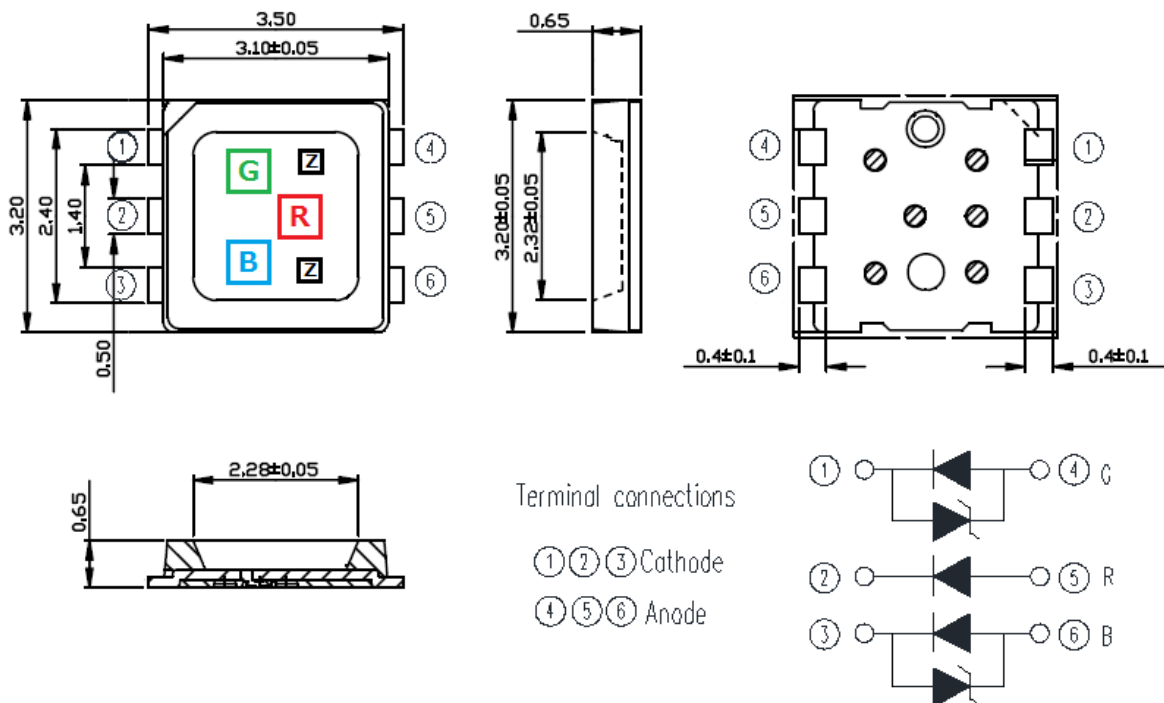

#### Notes

1. All dimensions are in millimeters.
2. Tolerance is  $\pm 0.2$  mm (.008") unless otherwise noted.
3. Injection point: The bottom of injection point remainder must be at least higher than the leads.
4. The heat slug is electrically conducted

## Specific Lighting LTW-Q35ZRGB

### 3. Absolute Maximum Ratings at Ta=25°C

Parameter	Symbol	Rating			Unit
		R	G	B	
Power Dissipation	P <sub>o</sub>	96	144	144	mW
Total Power Dissipation	P <sub>o</sub>	180			mW
Peak Forward Current <sup>1</sup>	I <sub>FP</sub>	100	100	100	mA
Continuous Forward Current	I <sub>F</sub>	40	40	40	mA
Reverse Voltage <sup>2</sup>	V <sub>R</sub>	5			V
Operating Temperature Range	T <sub>opr</sub>	-40 ~ +80			°C
Storage Temperature Range	T <sub>stg</sub>	-40 ~ +100			°C
Soldering Condition	T <sub>sol</sub>	260°C For 5 Seconds			

#### Notes

1. I<sub>FP</sub> condition should be ≤ 1/10 duty cycle, and ≤ 10ms pulse width
2. Operating the LED (in an application) under reverse bias condition might result in damage or failure of the component

### 4. Suggest IR Reflow Condition

#### R-Reflow Soldering Profile for lead free soldering (Acc. to J-STD-020D)

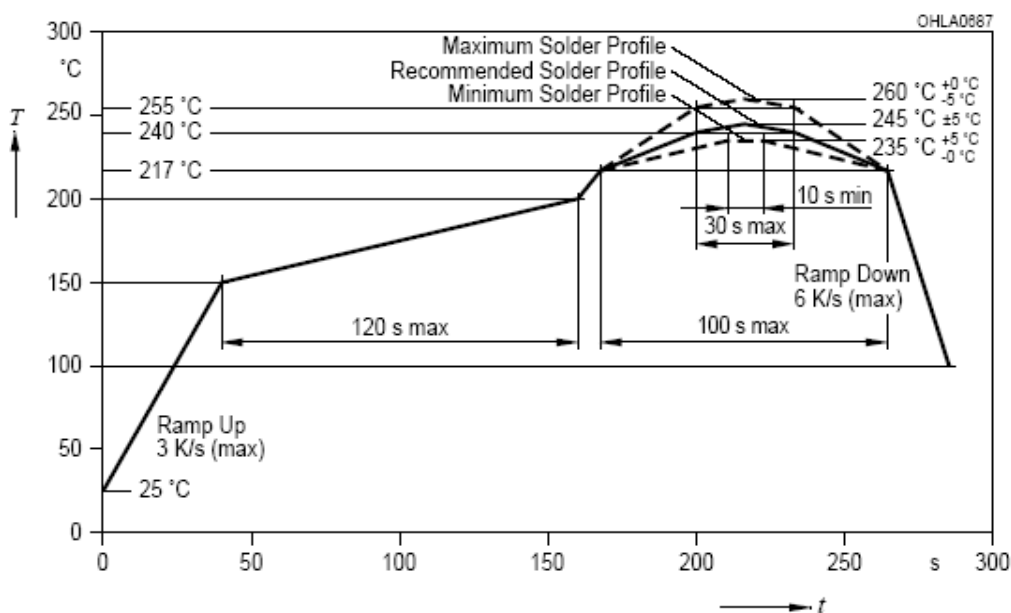

## Specific Lighting LTW-Q35ZRGB

### 5. Electro-Optical Characteristics at Ta=25°C

Parameter	Symbol	Color	Values			Test Condition	Unit
			Min	Typ.	Max		
Luminous Flux <sup>1</sup>	$\Phi_v$	R	1.65	2.55	-	R: $I_f = 20\text{mA}$ G: $I_f = 20\text{mA}$ B: $I_f = 20\text{mA}$	lm
		G	5.30	7.35	-		
		B	0.70	0.95	-		
Luminous Intensity	$I_v$	R	600	920	-	R: $I_f = 20\text{mA}$ G: $I_f = 20\text{mA}$ B: $I_f = 20\text{mA}$	mcd
		G	1920	2500	-		
		B	250	340	-		
Luminous Flux	$\Phi_v$	W	8.00	10.50	-	R: $I_f = 25\text{mA}$ G: $I_f = 13\text{mA}$ B: $I_f = 15\text{mA}$	lm
Luminous Intensity	$I_v$	W	2900	3500	-		mcd
Viewing Angle	$2\theta_{1/2}$	W.	-	130	-	R: $I_f = 20\text{mA}$ G: $I_f = 20\text{mA}$ B: $I_f = 20\text{mA}$	°
Dominant Wavelength <sup>2</sup>	$\lambda_d$	R	618	-	628	R: $I_f = 20\text{mA}$ G: $I_f = 20\text{mA}$ B: $I_f = 20\text{mA}$	nm
		G	520	-	530		
		B	465	-	475		
Forward Voltage <sup>3</sup>	$V_F$	R	1.8	2.1	2.4	R: $I_f = 20\text{mA}$ G: $I_f = 20\text{mA}$ B: $I_f = 20\text{mA}$	V
		G	2.7	2.9	3.5		
		B	2.7	3.0	3.5		
ESD-Withstand Voltage	ESD	-	8K	-	-	HBM	V

#### Notes

1. Tolerance of Luminous Intensity +/- 10%.
2. Tolerance of Dominant Wavelength +/- 1nm.
3. Tolerance of Forward Voltage +/- 0.1V
4. The chromaticity coordinates (x, y) is derived from the 1931 CIE chromaticity diagram.
5. Caution in ESD: Static Electricity and surge damages the LED. It is recommend to use a wrist band or anti-electrostatic glove when handling the LED. All devices, equipment and machinery must be properly grounded.
6. CAS140B is the test standard for the chromaticity coordinates (x, y) & lm.

## Specific Lighting LTW-Q35ZRGB

### 6. Bin Code List

#### 6.1 Luminous Flux Spec

Luminous Flux Spec. Table		
Φv Bin	Luminous Flux (lm) at $I_F$ : R=25mA, G=13mA, B=15mA	
	Min.	Max.
V3	8.00	10.50
V4	10.50	12.55
V5	12.55	15.00
V6	15.00	17.50

Tolerance on each Luminous Intensity bin and Luminous Flux are +/- 10%

#### 6.2 Color Ranks

Color Ranks Table											
Ranks	Color bin limits					Ranks	Color bin limits				
	$I_F$ : R=25mA, G=13mA, B=15mA						$I_F$ : R=25mA, G=13mA, B=15mA				
A1	x	0.257	0.257	0.282	0.282	C1	x	0.307	0.307	0.332	0.332
	y	0.220	0.245	0.255	0.230		y	0.240	0.265	0.275	0.250
A2	x	0.257	0.257	0.282	0.282	C2	x	0.307	0.307	0.332	0.332
	y	0.245	0.270	0.280	0.255		y	0.265	0.290	0.300	0.275
A3	x	0.257	0.257	0.282	0.282	C3	x	0.307	0.307	0.332	0.332
	y	0.270	0.295	0.305	0.280		y	0.290	0.315	0.325	0.300
A4	x	0.257	0.257	0.282	0.282	C4	x	0.307	0.307	0.332	0.332
	y	0.295	0.320	0.330	0.305		y	0.315	0.340	0.350	0.325
B1	x	0.282	0.282	0.307	0.307	D1	x	0.332	0.332	0.357	0.357
	y	0.230	0.255	0.265	0.240		y	0.250	0.275	0.285	0.260
B2	x	0.282	0.282	0.307	0.307	D2	x	0.332	0.332	0.357	0.357
	y	0.255	0.280	0.290	0.265		y	0.275	0.300	0.310	0.285
B3	x	0.282	0.282	0.307	0.307	D3	x	0.332	0.332	0.357	0.357
	y	0.280	0.305	0.315	0.290		y	0.300	0.325	0.335	0.310
B4	x	0.282	0.282	0.307	0.307	D4	x	0.332	0.332	0.357	0.357
	y	0.305	0.330	0.340	0.315		y	0.325	0.350	0.360	0.335

**Specific Lighting  
LTW-Q35ZRGB**

6.3 C.I.E 1931 Chromaticity Diagram for Color Ranks

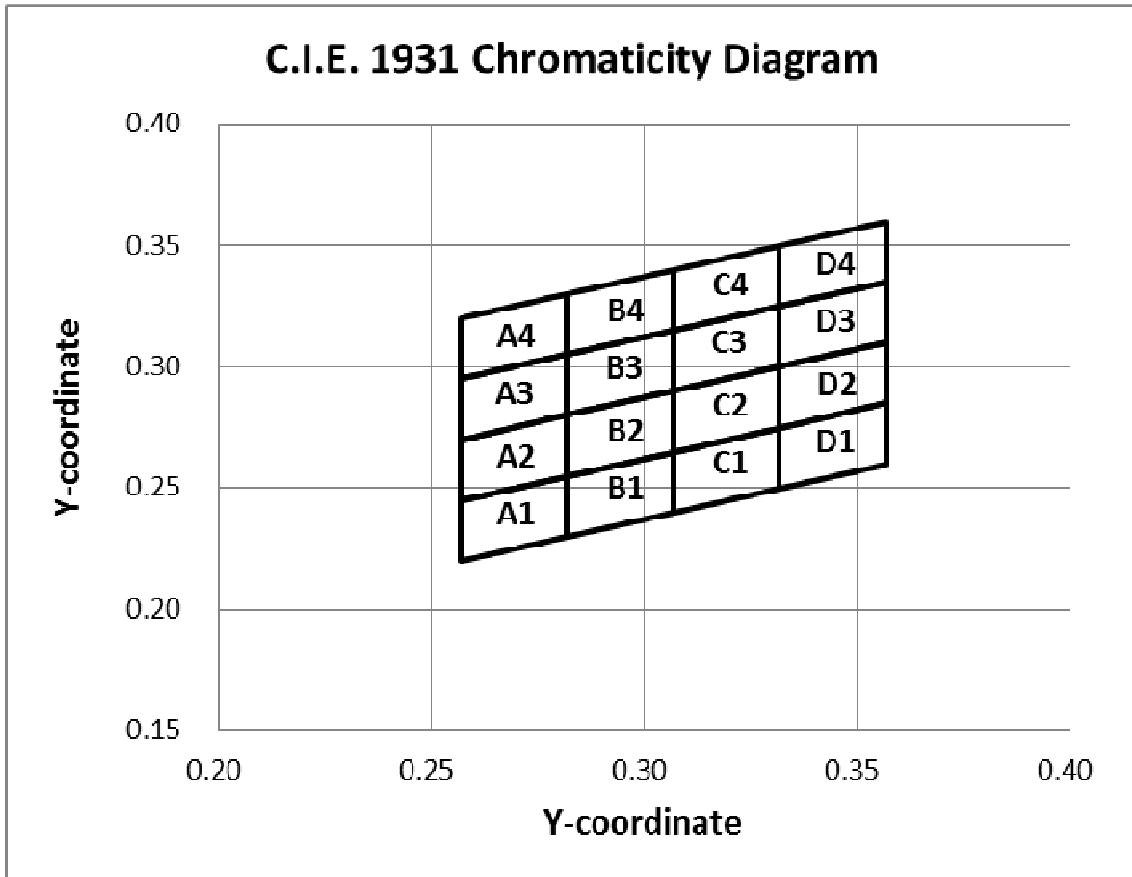

Tolerance on each Hue (x, y) bin is +/- 0.01

Specific Lighting  
LTW-Q35ZRGB

7. Typical Electrical / Optical Characteristics Curves  
(25°C Ambient Temperature Unless Otherwise Noted)

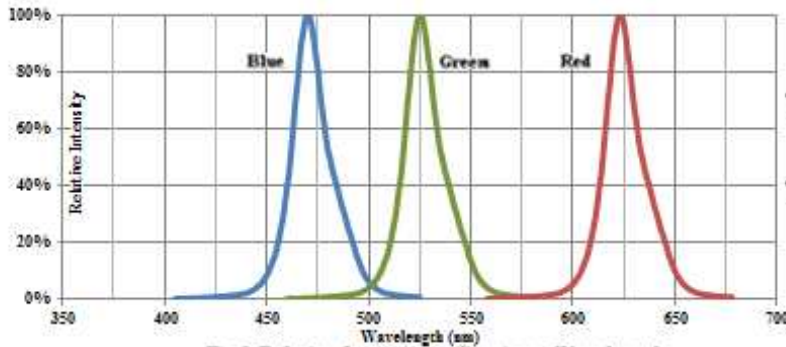
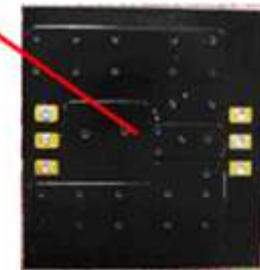
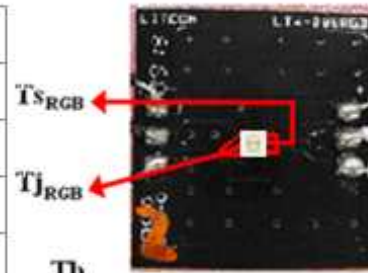

Fig.1 Relative Intensity vs Dominant Wavelength



Ts: Soldering Pin Temperature  
Tj: Junction Temperature  
Tb: Board Temperature

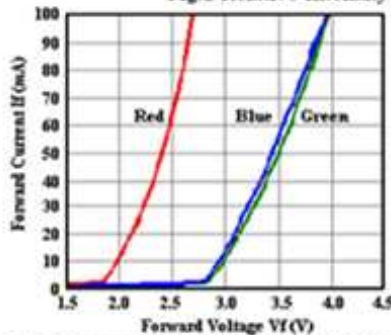

Fig.2 Forward Current vs Forward Voltage

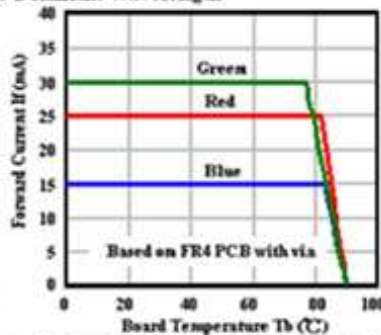

Fig.3 Forward Current Derating Curve

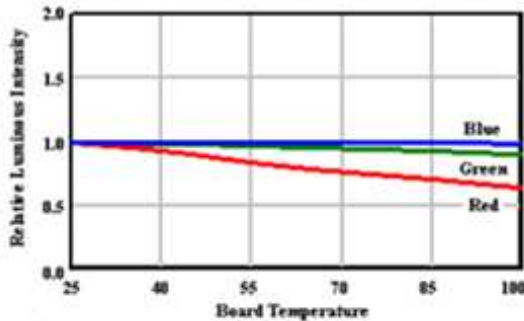

Fig.5 Luminous Intensity vs Board Temperature  
(The characteristic curve are the same as R, G and B chip lighting up simultaneously)

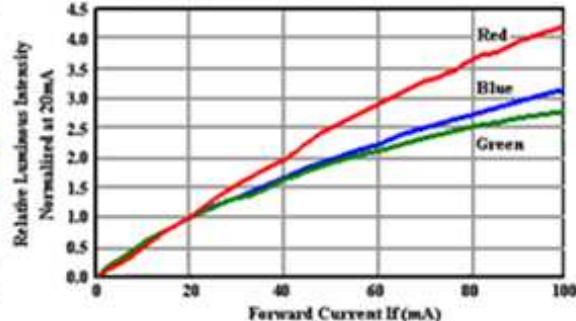

Fig.4 Relative Luminous Intensity vs Forward Current

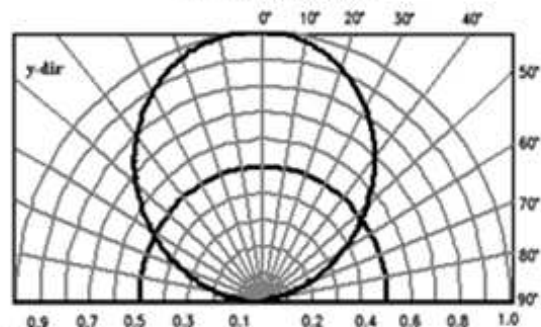
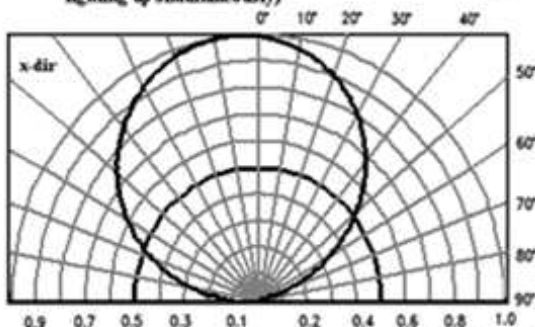

Fig.6 Spatial Distribution

## Specific Lighting LTW-Q35ZRGB

### 8. Reliability Test Plan

#### 8.1 Reliability conditions

Item	Test Item	Condition	Duration	Sample Size
P1	Resistance to soldering heat (RTSH) JEITA ED-4701 300 301	IR soldering according attached lead free (Refer to J-STD-020D.1)	10sec/3x	30
P2	Steady state life test(SSLT)	Ta=60°C If (RGB)=25/30/15mA	3000hrs	30
P3	Pulse life test(PLT)	Ta=60°C If (RGB)=25/30/15mA	3000hrs	30
P4	Temperature cycle (TC)	-20~25~85°C/ 30min each (mins trans)	500cycles	30
P5	Thermal shock (TS)	-40~105°C/5min each	100cycles	30
P6	High Temperature Storage (HTS)	100°C	1000hrs	30
P7	Low Temperature Storage (LTS)	-40°C	1000hrs	30
P8	High Temperature/High Humidity (WHTS)	85°C/85%	1000hrs	30

#### 8.2 Criteria for Judging the Damage

Item	Symbol	Test Condition	Criteria for Judgment	
			Min.	Max.
Forward Voltage	VF	IF =Typical Current		U.S.L. x 1.1
Luminous Flux	Lm	IF =Typical Current	L.S.L. x 0.5	
CCX & CCY (mixing white)	X,Y	IF =Typical Current		Shift<0.02

#### Notes

1. Operating life tests are mounted on thermal heat sink
2. Storage items are only component, not put on heat sink.



Specific Lighting  
LTW-Q35ZRGB

9. User Guide

9.1 Cleaning

Do not use unspecified chemical liquid to clean LED they could harm the package.

If cleaning is necessary, immerse the LED in ethyl alcohol or isopropyl alcohol at normal temperature for less than one minute.

9.2 Recommend Printed Circuit Board Attachment Pad

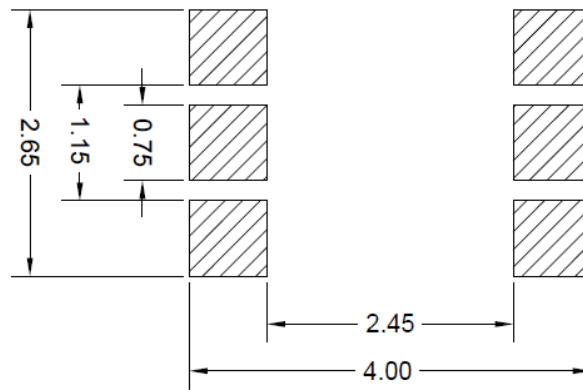

Infrared / vapor phase Reflow Soldering

9.3 Package Dimensions of Tape

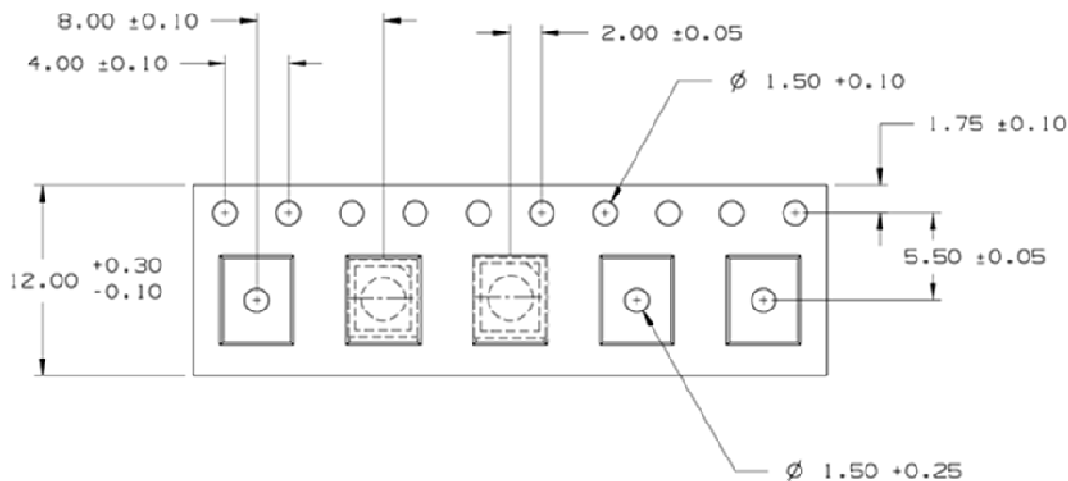

Notes All dimensions are in mm.

**Specific Lighting  
LTW-Q35ZRGB**

9.4 Package Dimensions of Reel

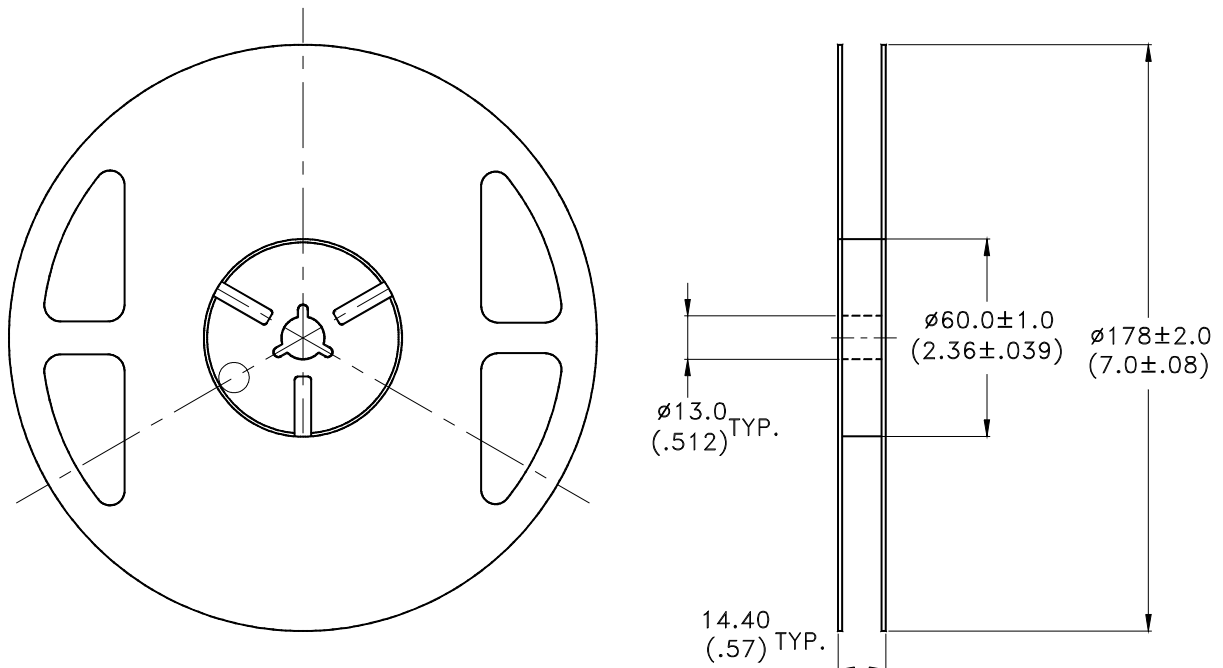

**Notes**

1. Empty component pockets sealed with top cover tape.
2. 7 inch reel- maximum 2000 pieces per reel.
3. The maximum number of consecutive missing lamps is two.
4. In accordance with EIA-481-1-B specifications.

## Specific Lighting LTW-Q35ZRGB

### 10. CAUTIONS

#### 10.1 Application

The LEDs described here are intended to be used for ordinary electronic equipment (such as office equipment, communication equipment and household applications). Consult Liteon's Sales in advance for information on applications in which exceptional reliability is required, particularly when the failure or malfunction of the LEDs may directly jeopardize life or health (such as in aviation, transportation, traffic control equipment, medical and life support systems and safety devices).

#### 10.2 Storage

This product is qualified as Moisture sensitive Level 3 per JEDEC J-STD-020 Precaution when handling this moisture sensitive product is important to ensure the reliability of the product.

The package is sealed:

The LEDs should be stored at 30°C or less and 90%RH or less. And the LEDs are limited to use within one year, while the LEDs is packed in moisture-proof package with the desiccants inside.

The package is opened:

The LEDs should be stored at 30°C or less and 60%RH or less. Moreover, the LEDs are limited to solder process within 168hrs. If the Humidity Indicator shows the pink color in 10% even higher or exceed the storage limiting time since opened, that we recommended to baking LEDs at 60°C at least 48hrs. To seal the remainder LEDs return to package, it's recommended to be with workable desiccants in original package.

#### 10.3 Cleaning

Use alcohol-based cleaning solvents such as isopropyl alcohol to clean the LED if necessary.

#### 10.4 Soldering

Recommended soldering conditions:

Reflow soldering		Soldering iron	
Pre-heat	120~150°C	Temperature	300°C Max.
Pre-heat time	120 sec. Max.	Soldering time	3 sec. Max.
Soldering Temp.	260°C Max.		(one time only)
Soldering time	30 sec. Max.		

## Specific Lighting LTW-Q35ZRGB

### 10.5 Drive Method

An LED is a current-operated device. In order to ensure intensity uniformity on multiple LEDs connected in parallel in an application, it is recommended that a current limiting resistor be incorporated in the drive circuit, in series with each LED as shown in Circuit A below.

**Circuit model A**

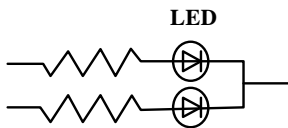

(A) Recommended circuit.

**Circuit model B**

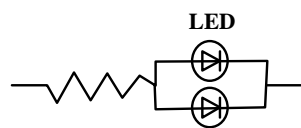

(B) The brightness of each LED might appear different due to the differences in the I-V characteristics of those LEDs.

### 10.6 ESD (Electrostatic Discharge)

Static Electricity or power surge will damage the LED.

Suggestions to prevent ESD damage:

- Use of a conductive wrist band or anti-electrostatic glove when handling these LEDs.
- All devices, equipment, and machinery must be properly grounded.
- Work tables, storage racks, etc. should be properly grounded.
- Use ion blower to neutralize the static charge which might have built up on surface of the LED's plastic lens as a result of friction between LEDs during storage and handling.

ESD-damaged LEDs will exhibit abnormal characteristics such as high reverse leakage current, low forward voltage, or "no light-up" at low currents.

To verify for ESD damage, check for "light-up" and  $V_f$  of the suspect LEDs at low currents.

The  $V_f$  of "good" LEDs should be  $>2.0V@0.1mA$  for InGaN product

## Specific Lighting LTW-Q35ZRGB

### 11. Suggested Checking List

#### ■ Training and Certification

1. Everyone working in a static-safe area is ESD-certified?
2. Training records kept and re-certification dates monitored?

#### ■ Static-Safe Workstation & Work Areas

1. Static-safe workstation or work-areas have ESD signs?
2. All surfaces and objects at all static-safe workstation and within 1 ft measure less than 100V?
3. All ionizer activated, positioned towards the units?
4. Each work surface mats grounding is good?

#### ■ Personnel Grounding

1. Every person (including visitors) handling ESD sensitive (ESDS) items wear wrist strap, heel strap or conductive shoes with conductive flooring?
2. If conductive footwear used, conductive flooring also present where operator stand or walk?
3. Garments, hairs or anything closer than 1 ft to ESD items measure less than 100V\*?
4. Every wrist strap or heel strap/conductive shoes checked daily and result recorded for all DLs?
5. All wrist strap or heel strap checkers calibration up to date?

Note: \*50V for Blue LED.

#### ■ Device Handling

1. Every ESDS items identified by EIA-471 labels on item or packaging?
2. All ESDS items completely inside properly closed static-shielding containers when not at static-safe workstation?
3. No static charge generators (e.g. plastics) inside shielding containers with ESDS items?
4. All flexible conductive and dissipative package materials inspected before reuse or recycle?

#### ■ Others

1. Audit result reported to entity ESD control coordinator?
2. Corrective action from previous audits completed?
3. Are audit records complete and on file?