

Click [here](#) for production status of specific part numbers.

MAXM17630/MAXM17631/ MAXM17632

4.5V to 36V, 1A Himalaya uSLIC Step-Down Power Module

General Description

The Himalaya series of voltage regulator ICs and power modules enable cooler, smaller, and simpler power supply solutions. The MAXM17630/MAXM17631/MAXM17632 are a family of high-efficiency, synchronous step-down DC-DC modules with integrated controller, MOSFETs, compensation components and inductor that operate over a wide input-voltage range. The modules operate from 4.5V to 36V and deliver up to 1A output current. The MAXM17630 and MAXM17631 are fixed 3.3V and 5V output modules, respectively. The MAXM17632 is an adjustable output (0.9V to 12V) module. The modules significantly reduce design complexity, manufacturing risks, and offer a true plug-and-play power-supply solution, reducing time-to-market. Built-in compensation across the output-voltage range eliminates the need for external compensation components.

These modules feature peak-current-mode control architecture. The modules can be operated in pulse-width modulation (PWM), or pulse-frequency modulation (PFM), or discontinuous-conduction mode (DCM) to enable high efficiency under light-load conditions.

The feedback-voltage regulation accuracy over -40°C to +125°C for the module family is $\pm 1.2\%$. These power modules are available in a low profile, compact 16-pin, 3mm x 3mm x 1.75mm, uSLIC™ package. Simulation Models are available.

Applications

- Industrial Control Power Supplies
- General Purpose Point-of-Load
- Distributed Supply Regulation
- Base Station Power Supplies
- High Voltage Single-Board Systems
- Programmable Logic Controller

uSLIC is a trademark of Maxim Integrated Products, Inc.

Benefits and Features

- Easy to Use
 - Wide 4.5V to 36V Input
 - Adjustable 0.9V to 12V Output (MAXM17632)
 - Fixed 3.3V and 5V output versions (MAXM17630 and MAXM17631)
 - 400kHz to 2.2MHz Adjustable Frequency with External Clock Synchronization
 - $\pm 1.2\%$ Feedback Accuracy
 - Up to 1A Output Current
 - Internally Compensated
 - All Ceramic Capacitors
- High Efficiency
 - Selectable PWM-, PFM- or DCM-Mode of Operation
 - Auxiliary Bootstrap Supply (EXTVCC) for Improved Efficiency
 - Shutdown Current as Low as 2.8 μ A (typ)
- Flexible Design
 - Adjustable and Monotonic Startup with Prebiased Output Voltage
 - Built-In Output-Voltage Monitoring with $\overline{\text{RESET}}$ Pin
 - Programmable EN/UVLO Threshold
- Robust Operation
 - Hiccup-Mode Overload Protection
 - Overtemperature Protection
 - -40°C to +125°C Ambient Operating Temperature/ -40°C to +150°C Junction Temperature
- Rugged
 - Complies with CISPR22(EN55022) Class B Conducted and Radiated Emissions
 - Passes Drop, Shock, and Vibration Standards: JESD22-B103, B104, B111

[Ordering Information](#) appears at end of data sheet.

Typical Application Circuit

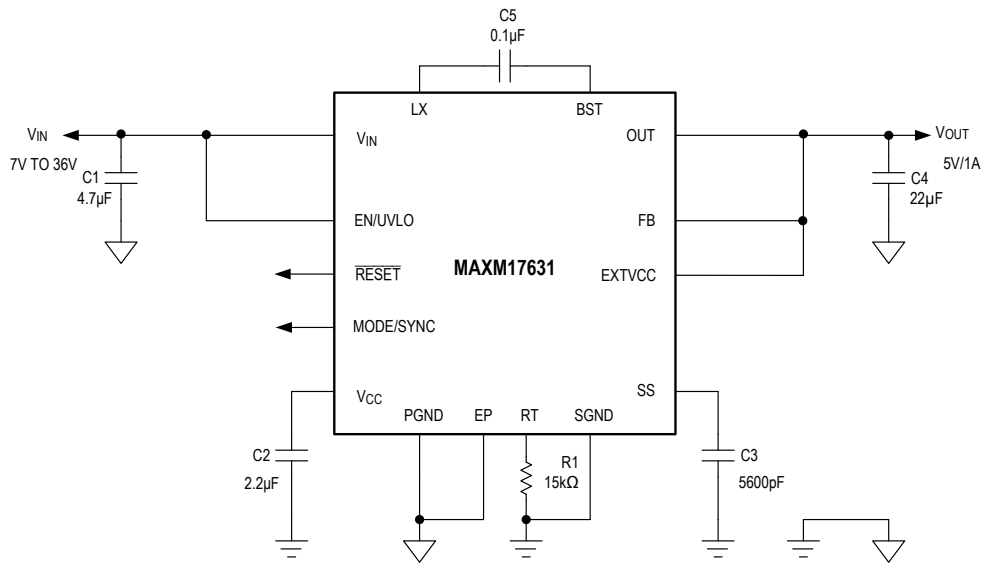

fsw: 1250kHz
C1: MURATA 4.7µF/X7R/50V/1206 (GRM31CR71H475KA12)
C4: MURATA 22µF/X7R/25V/1210 (GRM32ER71E226KE15)

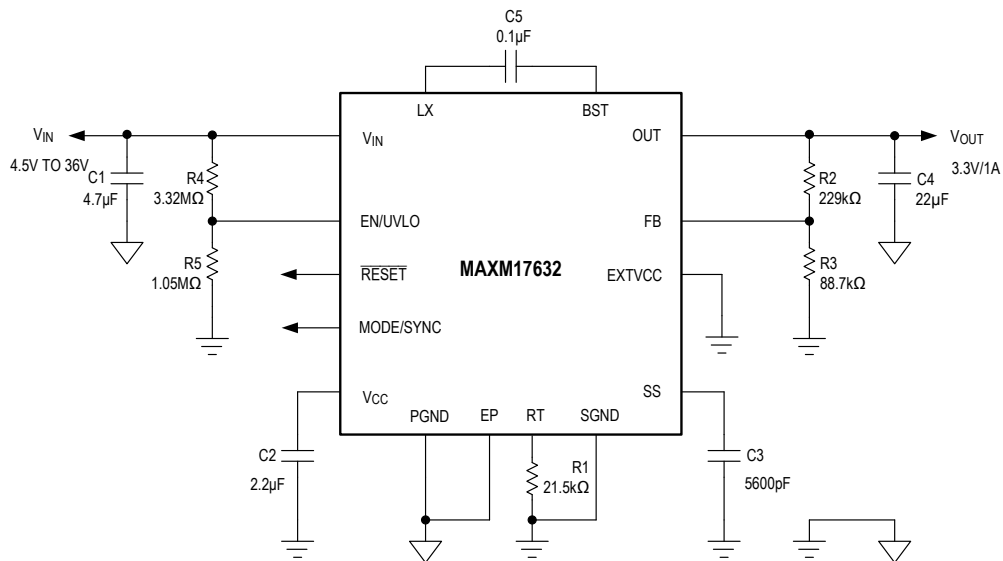

fsw: 900kHz
C1: MURATA 4.7µF/X7R/50V/1206 (GRM31CR71H475KA12)
C4: MURATA 22µF/X7R/25V/1210 (GRM32ER71E226KE15)

MAXM17630/MAXM17631/
MAXM17632

4.5V to 36V, 1A Himalaya uSLIC
Step-Down Power Module

Absolute Maximum Ratings

V _{IN} to PGND	-0.3V to +40V	FB to SGND(MAXM17632)	-0.3V to +6.5V
EN/UVLO to SGND	-0.3V to (V _{IN} + 0.3V)	PGND to SGND.....	-0.3V to +0.3V
LX, OUT to PGND.....	-0.3V to (V _{IN} + 0.3V)	Output Short-Circuit Duration	Continuous
EXTVCC to SGND	-5.5V to +6.5V	Operating Temperature Range (Note 1).....	-40°C to +125°C
BST to PGND	-0.3V to +46.5V	Junction Temperature (Note 1).....	+150°C
BST to LX.....	-0.3V to +6.5V	Storage Temperature Range.....	-55°C to +125°C
BST to V _{CC}	-0.3V to +40V	Lead Temperature (soldering, 10s)	+260°C
RESET, SS, MODE/SYNC, V _{CC} , RT to SGND ...	-0.3V to +6.5V	Soldering Temperature (reflow).....	+260°C
FB to SGND(MAXM17630/MAXM17631)	-5.5V to +6.5V		

Stresses beyond those listed under "Absolute Maximum Ratings" may cause permanent damage to the device. These are stress ratings only, and functional operation of the device at these or any other conditions beyond those indicated in the operational sections of the specifications is not implied. Exposure to absolute maximum rating conditions for extended periods may affect device reliability.

Package Information

PACKAGE TYPE: 16-Pin uSLIC	
Package Code	M1633+1
Outline Number	21-100298
Land Pattern Number	90-100110
THERMAL RESISTANCE, FOUR-LAYER BOARD (Note 2)	
Junction to Ambient (θ _{JA})	28°C/W

For the latest package outline information and land patterns (footprints), go to www.maximintegrated.com/packages. Note that a "+", "#", or "-" in the package code indicates RoHS status only. Package drawings may show a different suffix character, but the drawing pertains to the package regardless of RoHS status.

- Note 1:** Junction temperature greater than +125°C degrades operating lifetimes.
- Note 2:** Package thermal resistance is measured on an evaluation board with natural convection.

Electrical Characteristics

(V_{IN} = V_{EN/UVLO} = 24V, R_{RT} = open (f_{SW} = 400 kHz), C_{VCC} = 2.2µF, V_{MODE/SYNC} = V_{EXTVCC} = V_{SGND} = V_{PGND} = 0V, V_{FB} = 3.67V (MAXM17630), V_{FB} = 5.5V (MAXM17631), V_{FB} = 1V (MAXM17632), LX = SS = RESET = OUT = OPEN, V_{BST} to V_{LX} = 5V, T_A = -40°C to +125°C, unless otherwise noted. Typical values are at T_A = +25°C. All voltages are referenced to SGND, unless otherwise noted.) (Note 3)

PARAMETER	SYMBOL	CONDITIONS	MIN	TYP	MAX	UNITS
INPUT SUPPLY (V_{IN})						
Input Voltage Range	V _{IN}		4.5		36	V
Input Shutdown Current	I _{IN-SH}	V _{EN/UVLO} = 0V, shutdown mode		2.8	4.5	µA
Input-Quiescent Current	I _{Q-PFM}	MODE/SYNC = Open, V _{EXTVCC} = 5V, R _{RT} = 15kΩ		50		µA
	I _{Q-DCM}	MODE/SYNC = V _{CC} , V _{EXTVCC} = 5V, R _{RT} = 15kΩ		0.65		mA
	I _{Q-PWM}	MODE/SYNC = GND, V _{EXTVCC} = 5V, R _{RT} = 15kΩ, f _{SW} = 1250kHz		11		

Electrical Characteristics (continued)

($V_{IN} = V_{EN/UVLO} = 24V$, $R_{RT} = \text{open}$ ($f_{SW} = 400 \text{ kHz}$), $C_{VCC} = 2.2\mu F$, $V_{MODE/SYNC} = V_{EXTVCC} = V_{SGND} = V_{PGND} = 0V$, $V_{FB} = 3.67V$ (MAXM17630), $V_{FB} = 5.5V$ (MAXM17631), $V_{FB} = 1V$ (MAXM17632), $LX = SS = \text{RESET} = \text{OUT} = \text{OPEN}$, V_{BST} to $V_{LX} = 5V$, $T_A = -40^\circ C$ to $+125^\circ C$, unless otherwise noted. Typical values are at $T_A = +25^\circ C$. All voltages are referenced to SGND, unless otherwise noted.) (Note 3)

PARAMETER	SYMBOL	CONDITIONS	MIN	TYP	MAX	UNITS
ENABLE/UVLO (EN/UVLO)						
EN/UVLO Threshold	V_{ENR}	$V_{EN/UVLO}$ rising	1.19	1.215	1.26	V
	V_{ENF}	$V_{EN/UVLO}$ falling	1.068	1.09	1.131	
EN/UVLO Input Leakage Current	I_{EN}	$V_{EN/UVLO} = 0V$, $T_A = +25^\circ C$	-50		+50	nA
V_{CC} (LDO)						
V _{CC} Output-Voltage Range	V_{CC}	$6V < V_{IN} < 36V$, $0mA \leq I_{VCC} \leq 10mA$	4.75	5	5.25	V
V _{CC} Current Limit	$I_{VCC(MAX)}$	$V_{CC} = 4.5V$; $V_{IN} = 7.5V$	25	50		mA
V _{CC} Dropout	V_{CC-DO}	$V_{IN} = 4.5V$, $I_{VCC} = 10mA$			0.3	V
V _{CC} UVLO	V_{CC-UVR}	V_{CC} rising	4.05	4.2	4.3	V
V _{CC} UVLO	V_{CC-UVF}	V_{CC} falling	3.65	3.8	3.9	V
EXTVCC						
EXTVCC Switchover Threshold		V_{EXTVCC} rising	4.56	4.7	4.84	V
		V_{EXTVCC} falling	4.3	4.45	4.6	
SOFT-START (SS)						
Charging Current	I_{SS}	$V_{SS} = 0.5V$	4.7	5	5.3	μA
FEEDBACK (FB)						
FB Regulation Voltage	V_{FB-REG}	MODE/SYNC = SGND or MODE/SYNC = V_{CC} , for MAXM17630	3.26	3.3	3.34	V
		MODE/SYNC = SGND or MODE/SYNC = V_{CC} , for MAXM17631	4.94	5	5.06	
		MODE/SYNC = SGND or MODE/SYNC = V_{CC} , for MAXM17632	0.889	0.9	0.911	
		MODE/SYNC = Open, for MAXM17630	3.26	3.36	3.43	
		MODE/SYNC = Open, for MAXM17631	4.94	5.09	5.20	
		MODE/SYNC = Open, for MAXM17632	0.89	0.915	0.936	
FB Input-Bias Current	I_{FB}	For MAXM17630		11		μA
		For MAXM17631		17		
		$0 \leq V_{FB} \leq 1$, $T_A = 25^\circ C$, For MAXM17632	-50		+50	nA
MODE/SYNC						
MODE Threshold	V_{M-DCM}	MODE/SYNC = V_{CC} (DCM Mode)	$V_{CC} - 0.65$			V
	V_{M-PFM}	MODE/SYNC = Open (PFM Mode)	$V_{CC}/2$			
	V_{M-PWM}	MODE/SYNC = SGND (PWM mode)	0.75			
SYNC Frequency-Capture Range	f_{SYNC}	f_{SW} set by R_{RT}	$1.1 \times f_{SW}$		$1.4 \times f_{SW}$	kHz

Electrical Characteristics (continued)

($V_{IN} = V_{EN}/V_{VLO} = 24V$, $R_{RT} = \text{open}$ ($f_{SW} = 400 \text{ kHz}$), $C_{VCC} = 2.2\mu F$, $V_{MODE}/\text{SYNC} = V_{EXTVCC} = V_{SGND} = V_{PGND} = 0V$, $V_{FB} = 3.67V$ (MAXM17630), $V_{FB} = 5.5V$ (MAXM17631), $V_{FB} = 1V$ (MAXM17632), $LX = SS = \text{RESET} = \text{OUT} = \text{OPEN}$, V_{BST} to $V_{LX} = 5V$, $T_A = -40^\circ C$ to $+125^\circ C$, unless otherwise noted. Typical values are at $T_A = +25^\circ C$. All voltages are referenced to SGND, unless otherwise noted.) (Note 3)

PARAMETER	SYMBOL	CONDITIONS	MIN	TYP	MAX	UNITS
SYNC Pulse Width			50			ns
SYNC Threshold	V_{IH}		2.1			V
	V_{IL}				0.8	
RT						
Switching Frequency	f_{SW}	$R_{RT} = 50.8k\Omega$	380	400	420	kHz
		$R_{RT} = 40.2k\Omega$	475	500	525	
		$R_{RT} = 8.06k\Omega$	1950	2200	2450	
		$R_{RT} = \text{Open}$	370	400	430	
V_{FB} Undervoltage Trip Level to Cause Hiccup	$V_{FB-HICF}$	For MAXM17630	2.05	2.13	2.2	V
		For MAXM17631	3.11	3.22	3.33	
		For MAXM17632	0.56	0.58	0.6	
Hiccup Timeout			32678			Cycles
Minimum On-Time	$t_{ON(MIN)}$			52	80	ns
Minimum Off-Time	$t_{OFF(MIN)}$		140		160	ns
RESET						
RESET Output Level Low	$V_{RESETLKG}$	$I_{RESET} = 10mA$			400	mV
RESET Output-Leakage Current	$I_{RESETLKG}$	$T_A = T_J = 25^\circ C$, $V_{RESET} = 5.5V$	-100		+100	nA
FB Threshold for RESET Deassertion	V_{FB-OKR}	V_{FB} rising	93.8	95	97.8	%
FB Threshold for RESET Assertion	V_{FB-OKF}	V_{FB} falling	90.5	92	94.6	%
RESET Delay After FB Reaches 95% Regulation				1024		Cycles
THERMAL SHUTDOWN (TEMP)						
Thermal-Shutdown Threshold		Temperature rising		165		$^\circ C$
Thermal-Shutdown Hysteresis				10		$^\circ C$

Note 3: Electrical specifications are production tested at $T_A = +25^\circ C$. Specifications over the entire operating temperature range are guaranteed by design and characterization.

Typical Operating Characteristics

($V_{EN/UVLO} = V_{IN} = 24V$, $V_{SGND} = V_{PGND} = 0V$, $C_{VCC} = 2.2\mu F$, $C_{BST} = 0.1\mu F$, $C_{SS} = 5600pF$, $T_A = -40^\circ C$ to $+125^\circ C$, unless otherwise noted. Typical values are at $T_A = +25^\circ C$. All voltages are referenced to SGND, unless otherwise noted.)

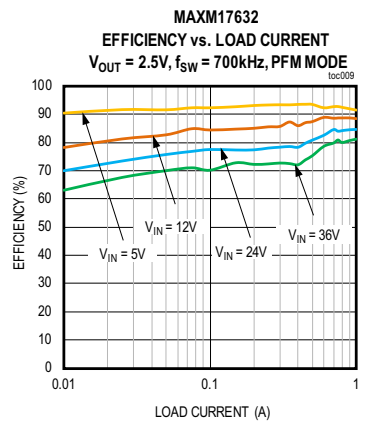
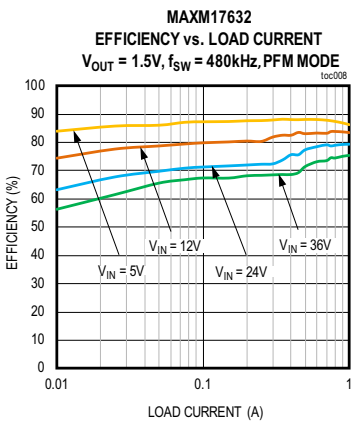
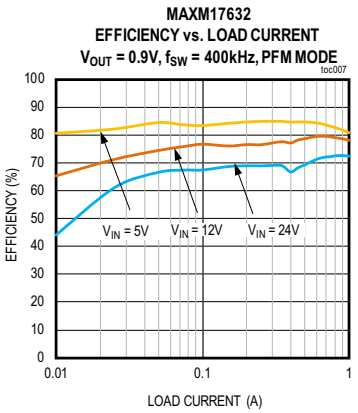
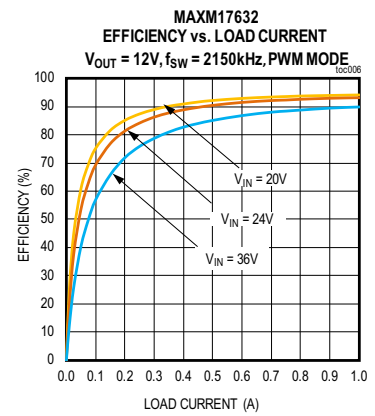
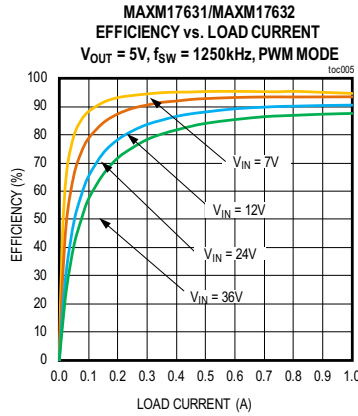
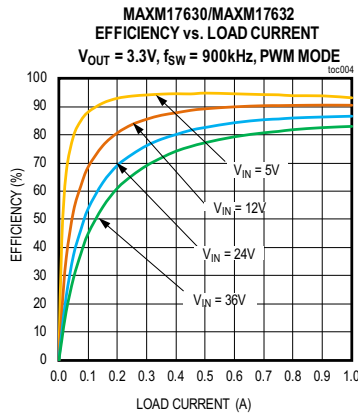
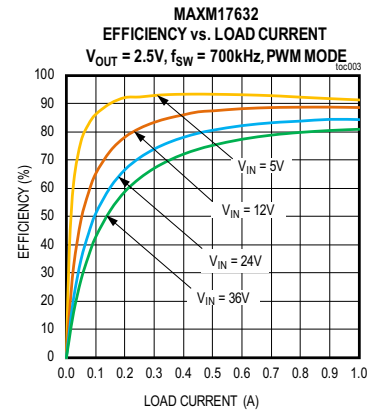
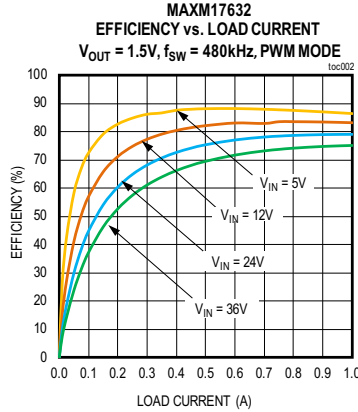
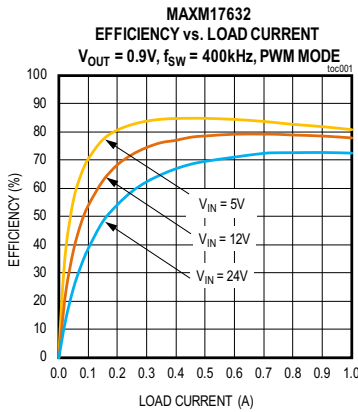

Typical Operating Characteristics (continued)

($V_{EN}/UVLO = V_{IN} = 24V$, $V_{SGND} = V_{PGND} = 0V$, $C_{VCC} = 2.2\mu F$, $C_{BST} = 0.1\mu F$, $C_{SS} = 5600pF$, $T_A = -40^\circ C$ to $+125^\circ C$, unless otherwise noted. Typical values are at $T_A = +25^\circ C$. All voltages are referenced to SGND, unless otherwise noted.)

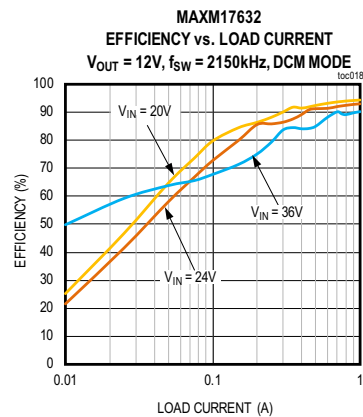
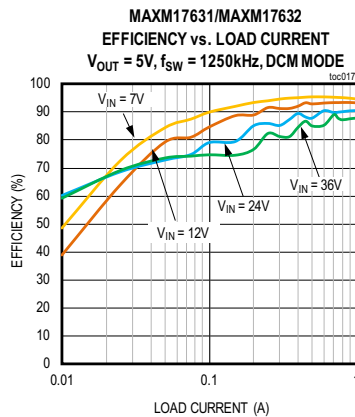
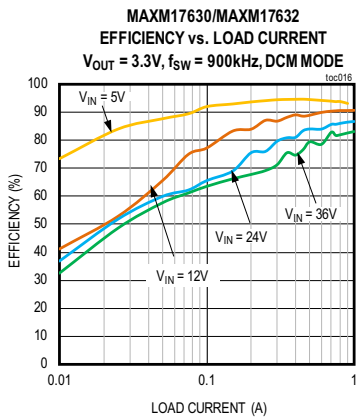
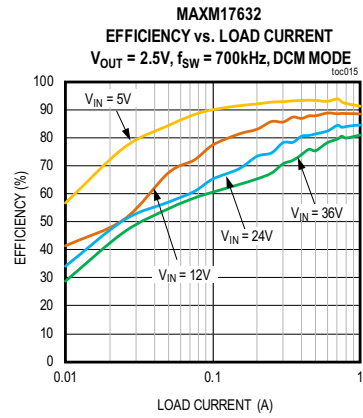
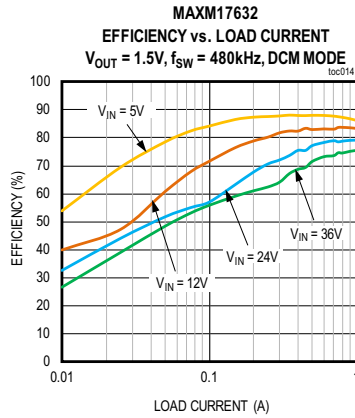
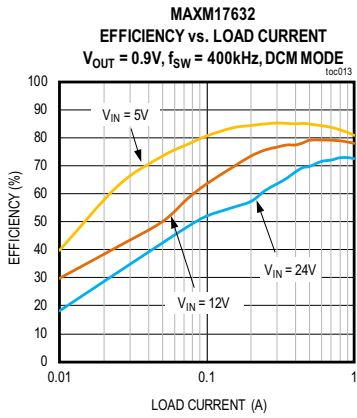
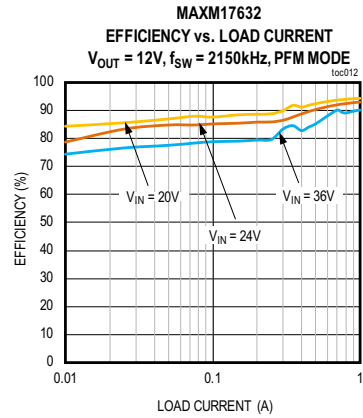
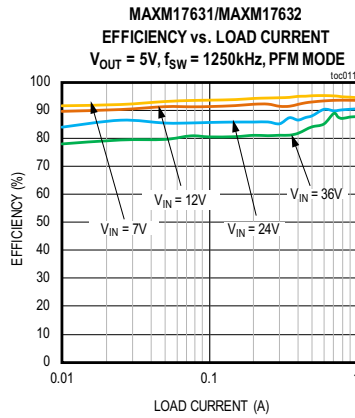
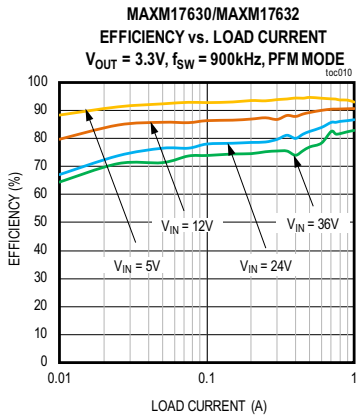

Typical Operating Characteristics (continued)

($V_{EN}/V_{VLO} = V_{IN} = 24V$, $V_{SGND} = V_{PGND} = 0V$, $C_{VCC} = 2.2\mu F$, $C_{BST} = 0.1\mu F$, $C_{SS} = 5600pF$, $T_A = -40^\circ C$ to $+125^\circ C$, unless otherwise noted. Typical values are at $T_A = +25^\circ C$. All voltages are referenced to SGND, unless otherwise noted.)

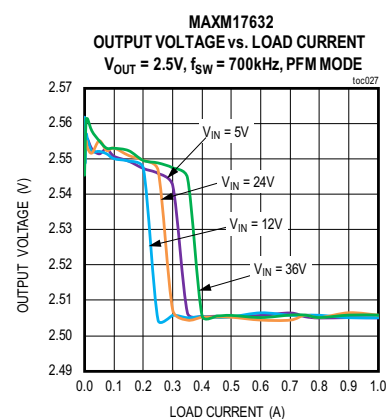
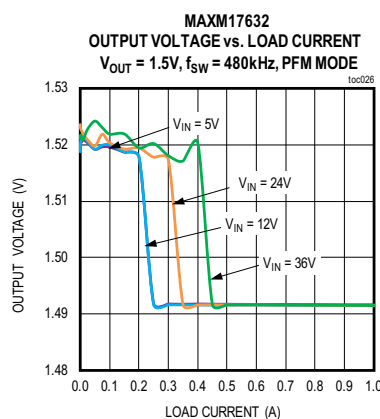
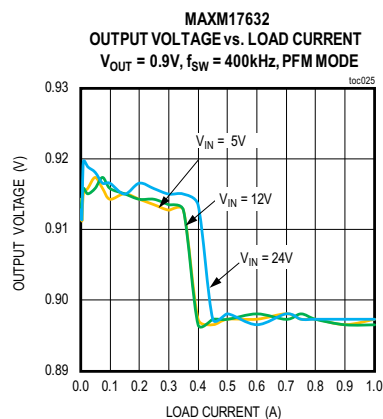
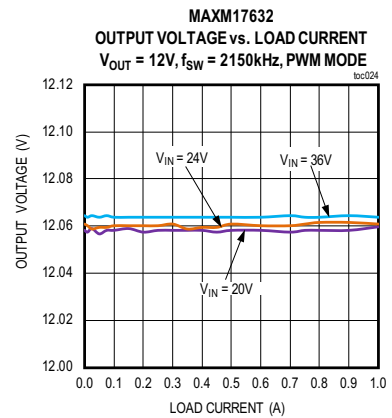
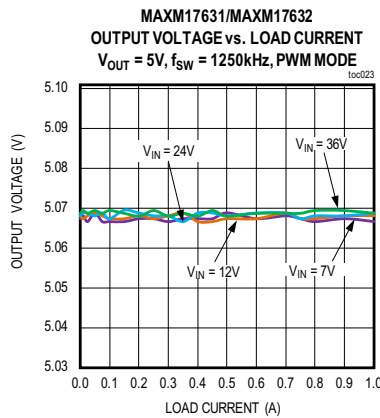
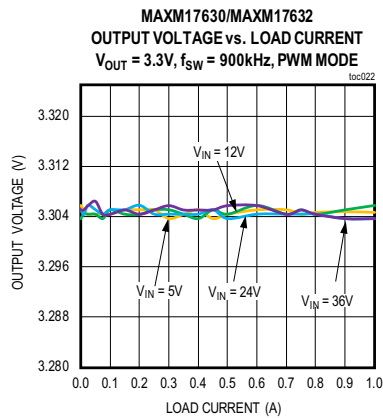
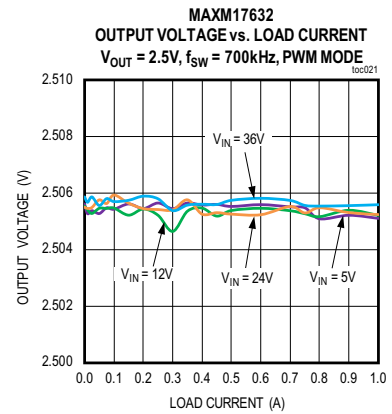
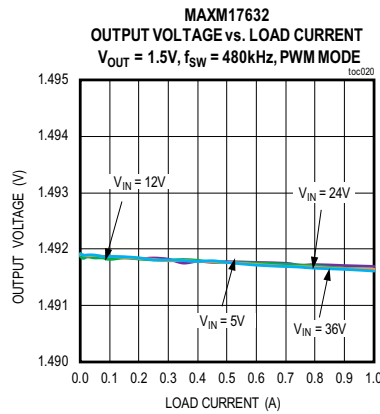
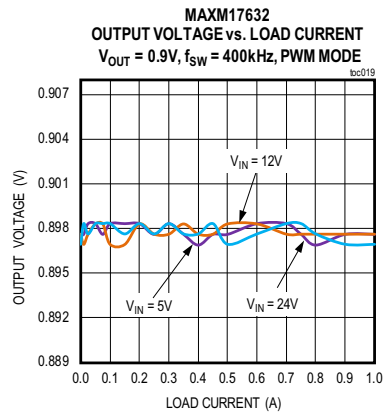

Typical Operating Characteristics (continued)

($V_{EN}/UVLO = V_{IN} = 24V$, $V_{SGND} = V_{PGND} = 0V$, $C_{VCC} = 2.2\mu F$, $C_{BST} = 0.1\mu F$, $C_{SS} = 5600pF$, $T_A = -40^\circ C$ to $+125^\circ C$, unless otherwise noted. Typical values are at $T_A = +25^\circ C$. All voltages are referenced to SGND, unless otherwise noted.)

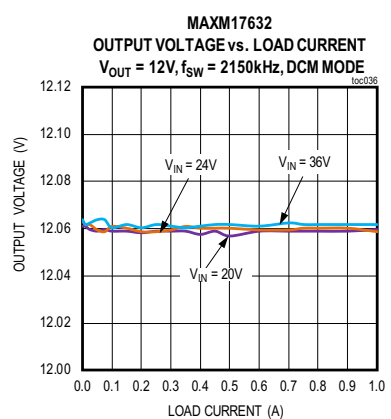
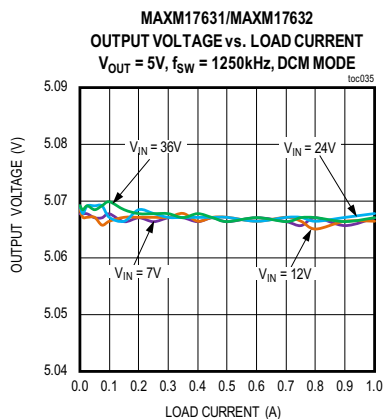
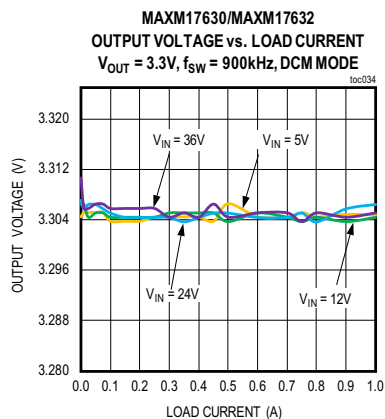
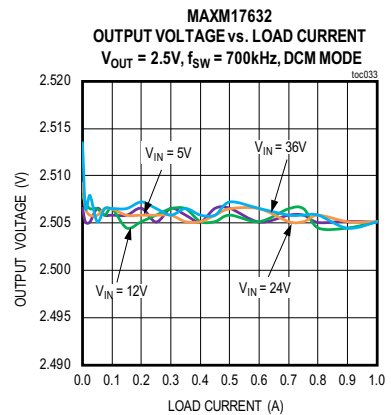
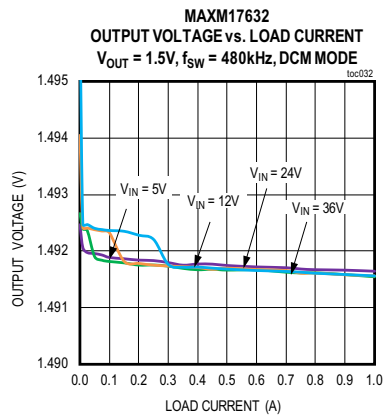
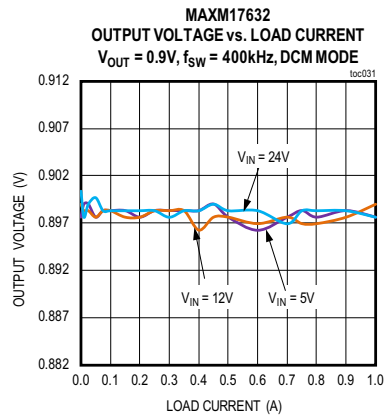
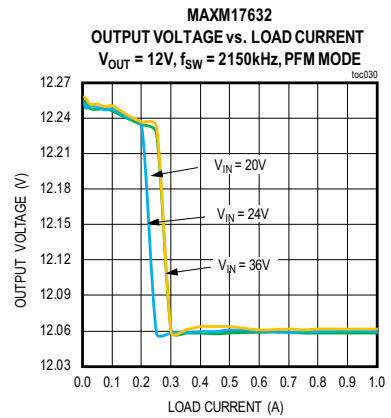
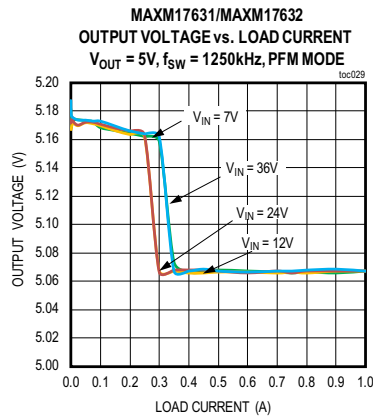
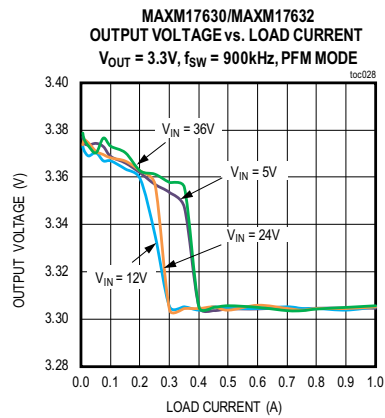

Typical Operating Characteristics (continued)

($V_{EN/UVLO} = V_{IN} = 24V$, $V_{SGND} = V_{PGND} = 0V$, $C_{VCC} = 2.2\mu F$, $C_{BST} = 0.1\mu F$, $C_{SS} = 5600pF$, $T_A = -40^\circ C$ to $+125^\circ C$, unless otherwise noted. Typical values are at $T_A = +25^\circ C$. All voltages are referenced to SGND, unless otherwise noted.)

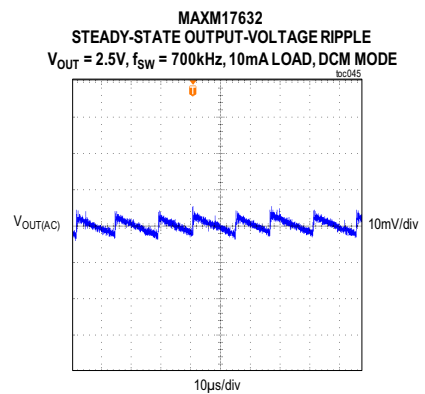
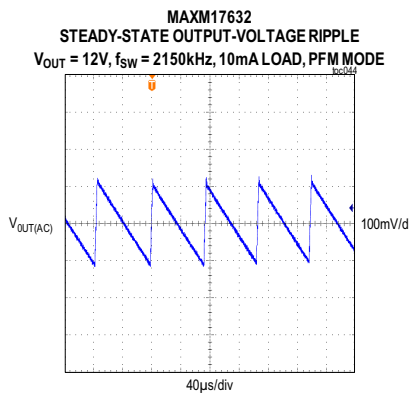
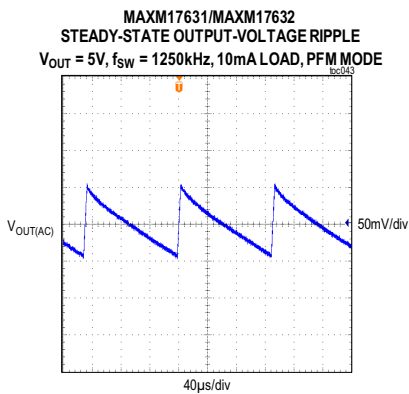
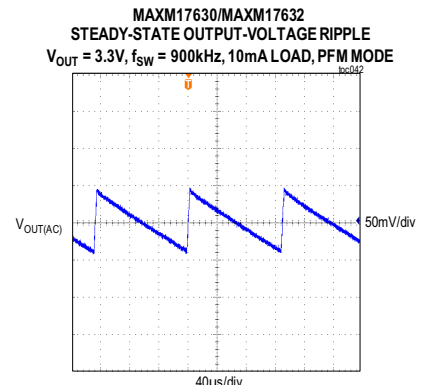
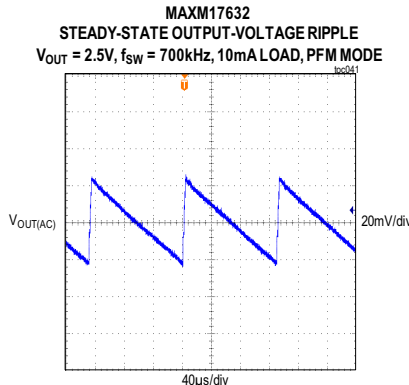
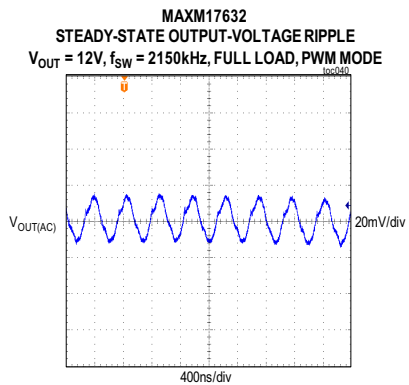
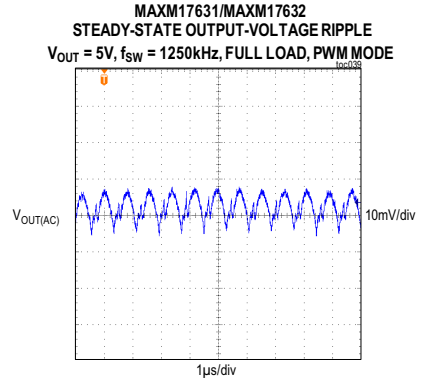
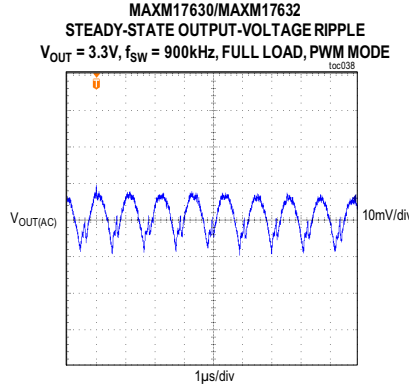
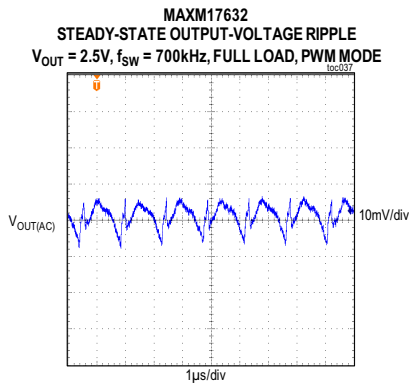

Typical Operating Characteristics (continued)

($V_{EN/UVLO} = V_{IN} = 24V$, $V_{SGND} = V_{PGND} = 0V$, $C_{VCC} = 2.2\mu F$, $C_{BST} = 0.1\mu F$, $C_{SS} = 5600pF$, $T_A = -40^{\circ}C$ to $+125^{\circ}C$, unless otherwise noted. Typical values are at $T_A = +25^{\circ}C$. All voltages are referenced to SGND, unless otherwise noted.)

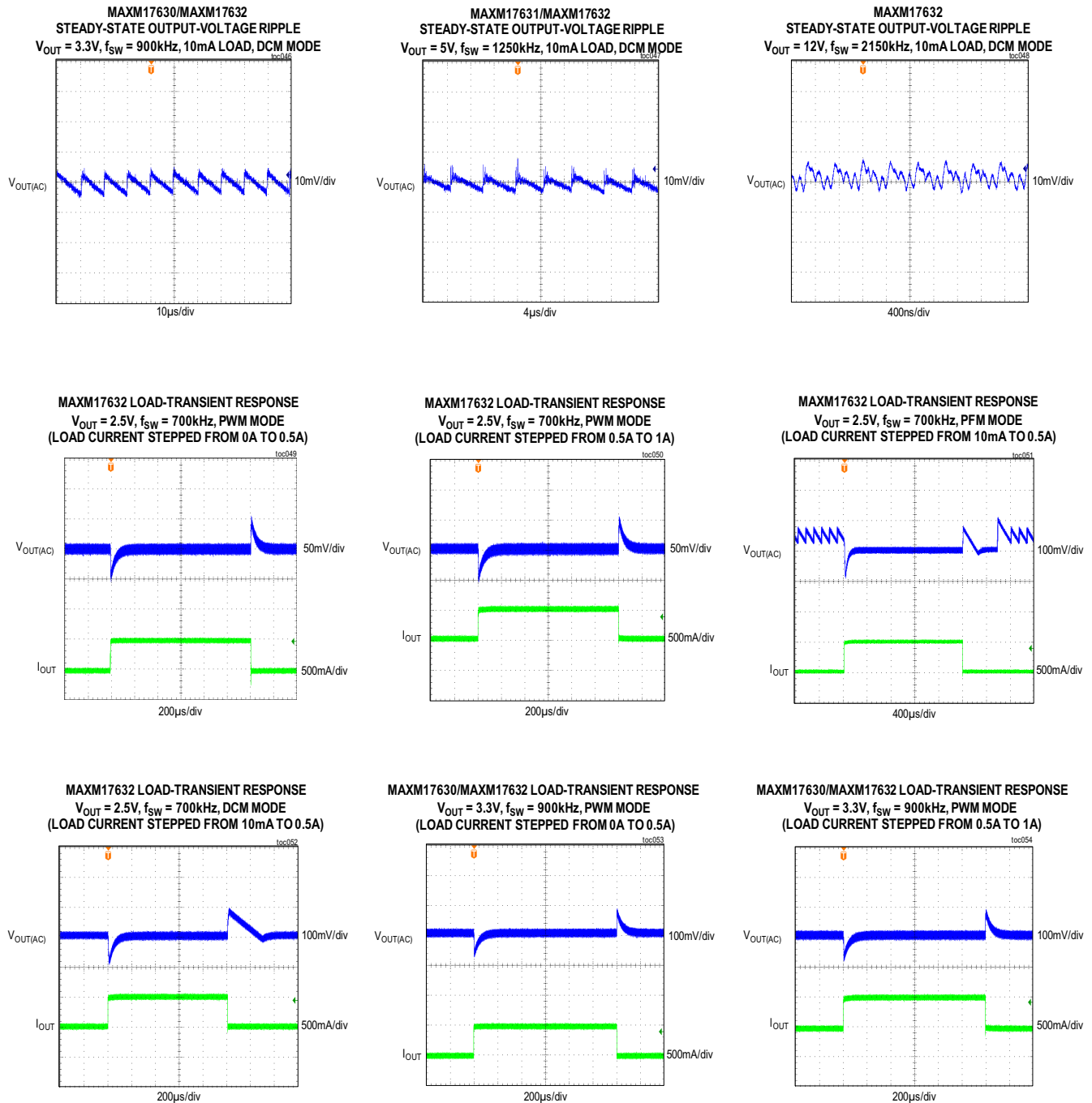

Typical Operating Characteristics (continued)

($V_{EN/UVLO} = V_{IN} = 24V$, $V_{SGND} = V_{PGND} = 0V$, $C_{VCC} = 2.2\mu F$, $C_{BST} = 0.1\mu F$, $C_{SS} = 5600pF$, $T_A = -40^\circ C$ to $+125^\circ C$, unless otherwise noted. Typical values are at $T_A = +25^\circ C$. All voltages are referenced to SGND, unless otherwise noted.)

MAXM17630/MAXM17632 LOAD-TRANSIENT RESPONSE
 $V_{OUT} = 3.3V$, $f_{SW} = 900kHz$, PWM MODE
(LOAD CURRENT STEPPED FROM 10mA TO 0.5A)

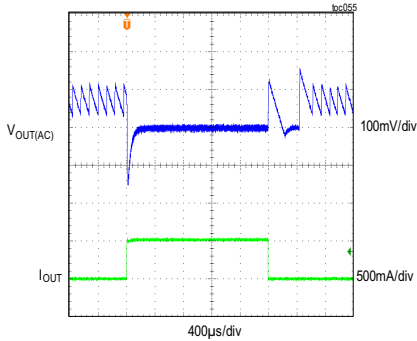

MAXM17630/MAXM17632 LOAD-TRANSIENT RESPONSE
 $V_{OUT} = 3.3V$, $f_{SW} = 900kHz$, DCM MODE
(LOAD CURRENT STEPPED FROM 10mA TO 0.5A)

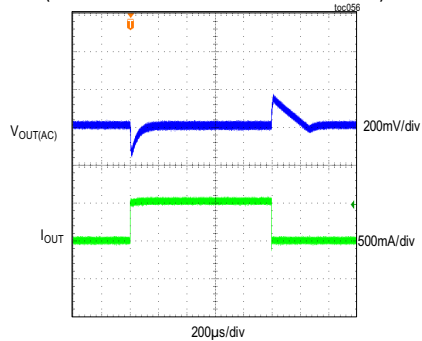

MAXM17631/MAXM17632 LOAD-TRANSIENT RESPONSE
 $V_{OUT} = 5V$, $f_{SW} = 1250kHz$, PWM MODE
(LOAD CURRENT STEPPED FROM 0A TO 0.5A)

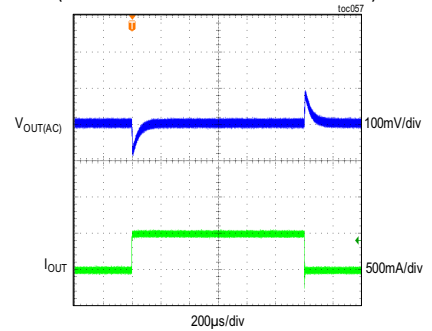

MAXM17631/MAXM17632 LOAD-TRANSIENT RESPONSE
 $V_{OUT} = 5V$, $f_{SW} = 1250kHz$, PWM MODE
(LOAD CURRENT STEPPED FROM 0.5A TO 1A)

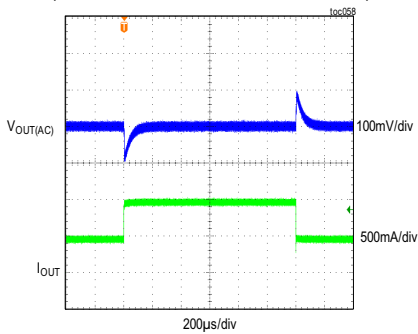

MAXM17631/MAXM17632 LOAD-TRANSIENT RESPONSE
 $V_{OUT} = 5V$, $f_{SW} = 1250kHz$, PWM MODE
(LOAD CURRENT STEPPED FROM 10mA TO 0.5A)

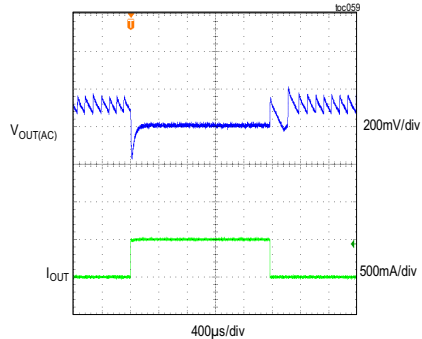

MAXM17631/MAXM17632 LOAD-TRANSIENT RESPONSE
 $V_{OUT} = 5V$, $f_{SW} = 1250kHz$, DCM MODE
(LOAD CURRENT STEPPED FROM 10mA TO 0.5A)

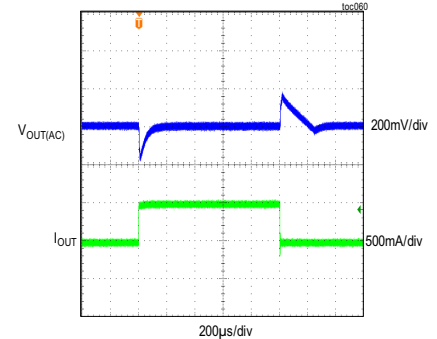

MAXM17632 LOAD-TRANSIENT RESPONSE
 $V_{OUT} = 12V$, $f_{SW} = 2150kHz$, PWM MODE
(LOAD CURRENT STEPPED FROM 0A TO 0.5A)

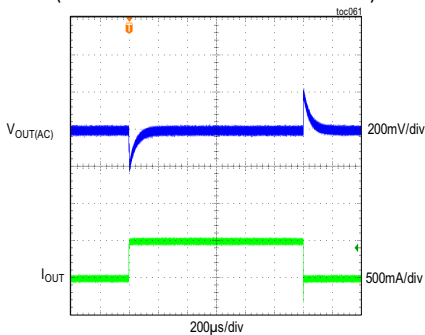

MAXM17632 LOAD-TRANSIENT RESPONSE
 $V_{OUT} = 12V$, $f_{SW} = 2150kHz$, PWM MODE
(LOAD CURRENT STEPPED FROM 0.5A TO 1A)

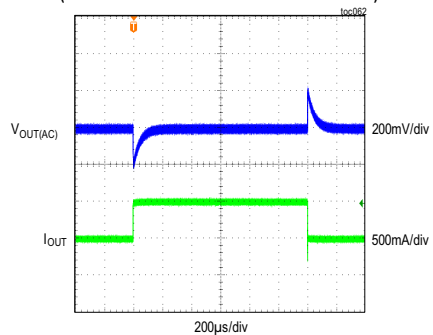

MAXM17632 LOAD-TRANSIENT RESPONSE
 $V_{OUT} = 12V$, $f_{SW} = 2150kHz$, PWM MODE
(LOAD CURRENT STEPPED FROM 10mA TO 0.5A)

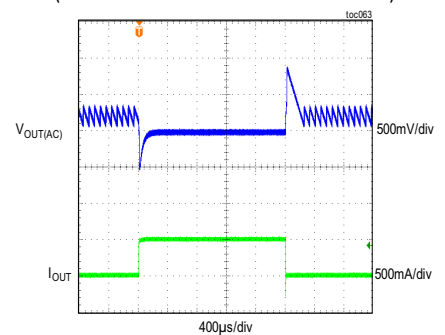

Typical Operating Characteristics (continued)

($V_{EN/UVLO} = V_{IN} = 24V$, $V_{SGND} = V_{PGND} = 0V$, $C_{VCC} = 2.2\mu F$, $C_{BST} = 0.1\mu F$, $C_{SS} = 5600pF$, $T_A = -40^\circ C$ to $+125^\circ C$, unless otherwise noted. Typical values are at $T_A = +25^\circ C$. All voltages are referenced to SGND, unless otherwise noted.)

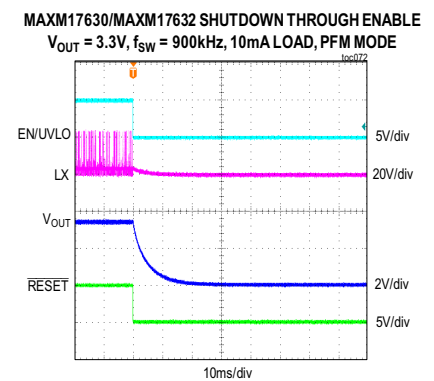
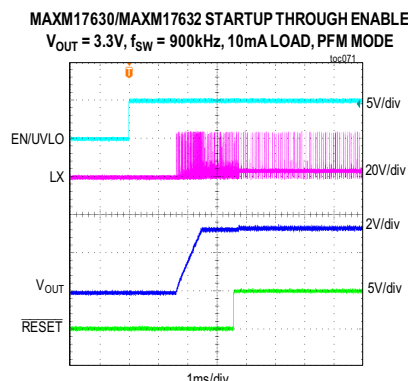
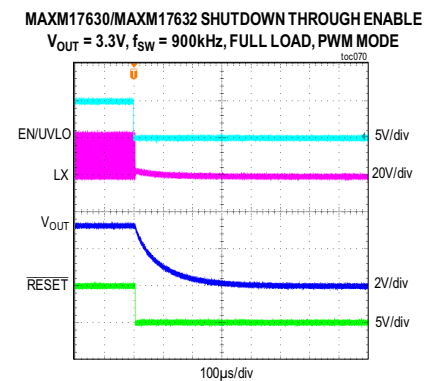
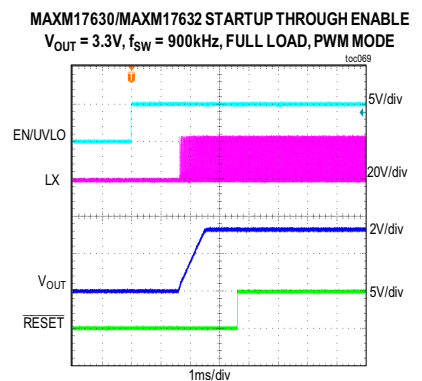
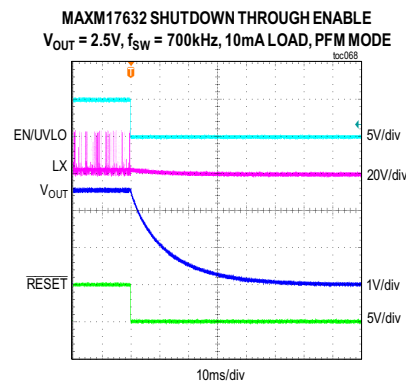
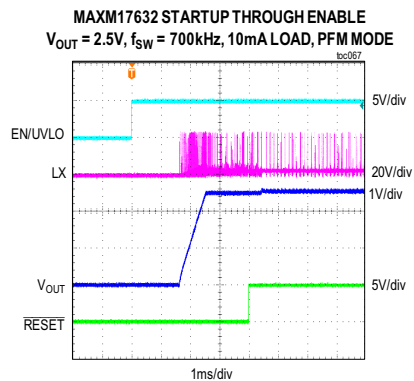
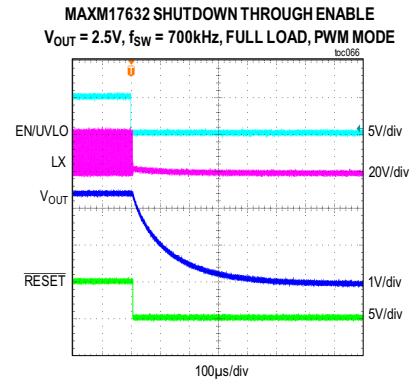
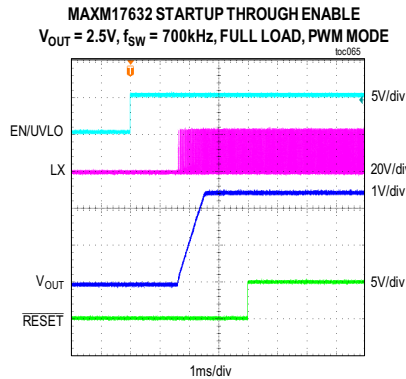
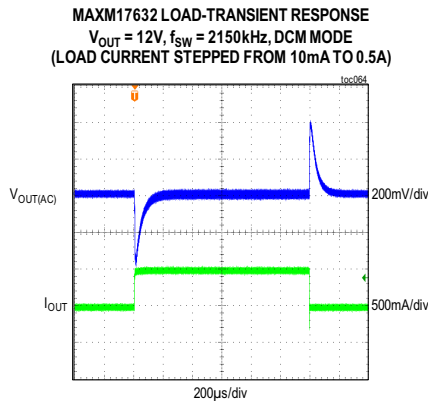

Typical Operating Characteristics (continued)

($V_{EN/UVLO} = V_{IN} = 24V$, $V_{SGND} = V_{PGND} = 0V$, $C_{VCC} = 2.2\mu F$, $C_{BST} = 0.1\mu F$, $C_{SS} = 5600pF$, $T_A = -40^\circ C$ to $+125^\circ C$, unless otherwise noted. Typical values are at $T_A = +25^\circ C$. All voltages are referenced to SGND, unless otherwise noted.)

MAXM17631/MAXM17632 STARTUP THROUGH ENABLE
 $V_{OUT} = 5V$, $f_{SW} = 1250kHz$, FULL LOAD, PWM MODE

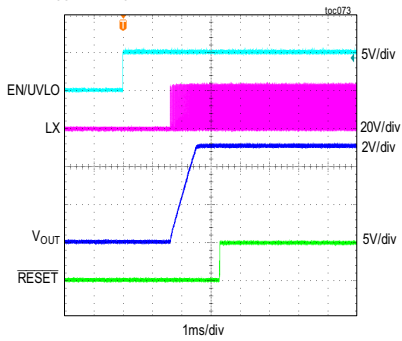

MAXM17631/MAXM17632 SHUTDOWN THROUGH ENABLE
 $V_{OUT} = 5V$, $f_{SW} = 1250kHz$, FULL LOAD, PWM MODE

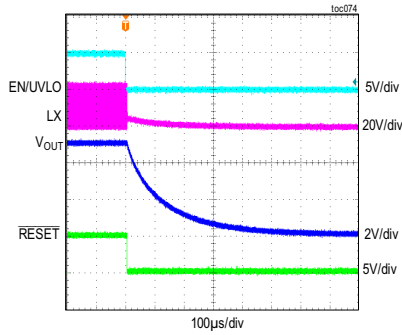

MAXM17631/MAXM17632 STARTUP THROUGH ENABLE
 $V_{OUT} = 5V$, $f_{SW} = 1250kHz$, 10mA LOAD, PFM MODE

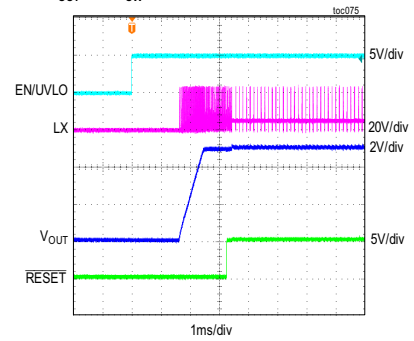

MAXM17631/MAXM17632 SHUTDOWN THROUGH ENABLE
 $V_{OUT} = 5V$, $f_{SW} = 1250kHz$, 10mA LOAD, PFM MODE

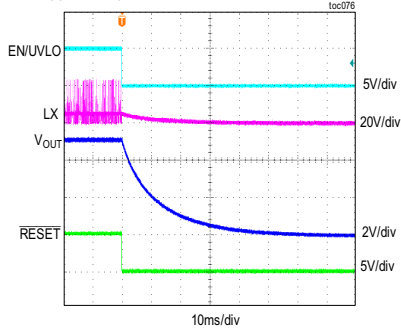

MAXM17632 STARTUP THROUGH V_{IN}
 $V_{OUT} = 2.5V$, $f_{SW} = 700kHz$, FULL LOAD, PWM MODE

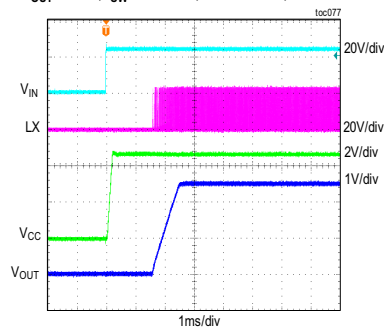

MAXM17632 SHUTDOWN THROUGH V_{IN}
 $V_{OUT} = 2.5V$, $f_{SW} = 700kHz$, FULL LOAD, PWM MODE

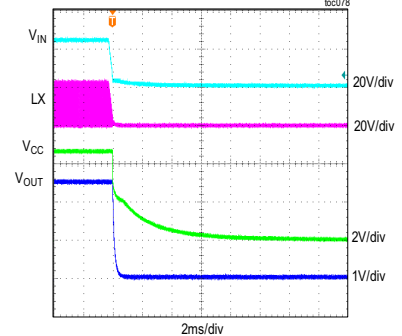

MAXM17632 STARTUP THROUGH V_{IN}
 $V_{OUT} = 2.5V$, $f_{SW} = 700kHz$, 10mA LOAD, PFM MODE

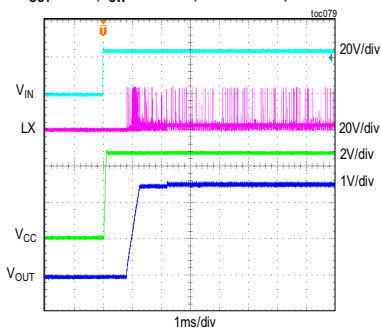

MAXM17632 SHUTDOWN THROUGH V_{IN}
 $V_{OUT} = 2.5V$, $f_{SW} = 700kHz$, 10mA LOAD, PFM MODE

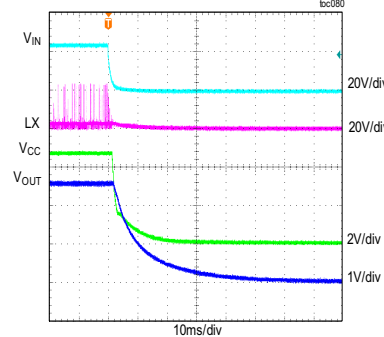

MAXM17630/MAXM17632 STARTUP THROUGH V_{IN}
 $V_{OUT} = 3.3V$, $f_{SW} = 900kHz$, FULL LOAD, PWM MODE

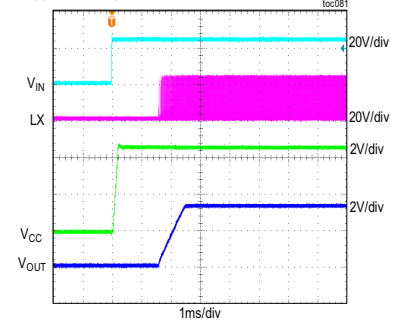

Typical Operating Characteristics (continued)

($V_{EN/UVLO} = V_{IN} = 24V$, $V_{SGND} = V_{PGND} = 0V$, $C_{VCC} = 2.2\mu F$, $C_{BST} = 0.1\mu F$, $C_{SS} = 5600pF$, $T_A = -40^{\circ}C$ to $+125^{\circ}C$, unless otherwise noted. Typical values are at $T_A = +25^{\circ}C$. All voltages are referenced to SGND, unless otherwise noted.)

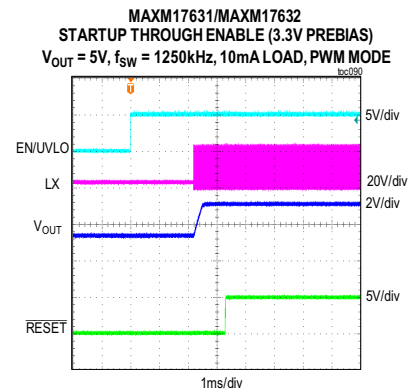
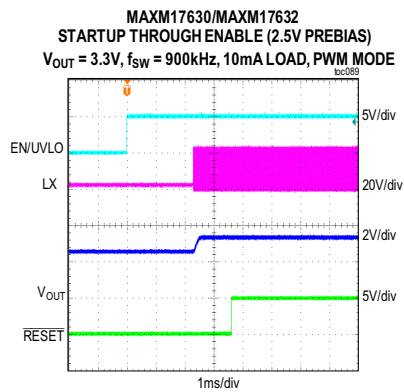
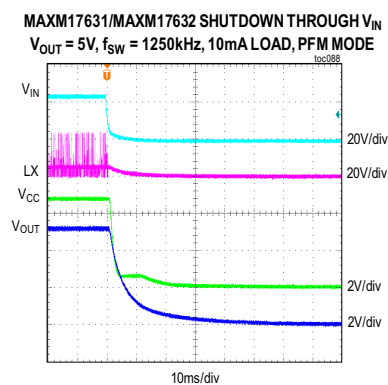
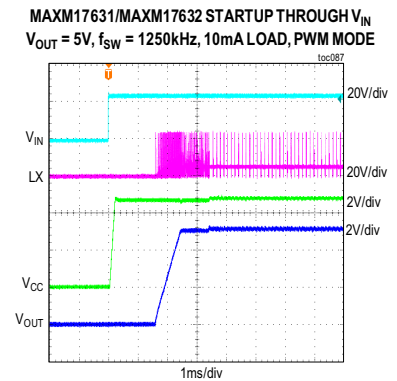
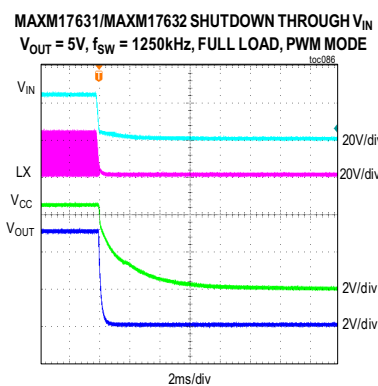
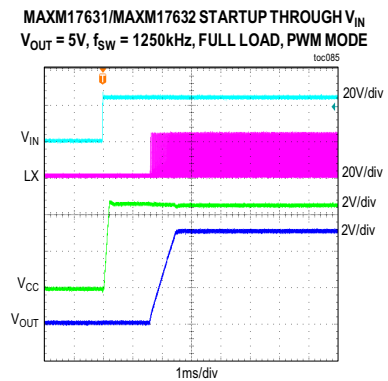
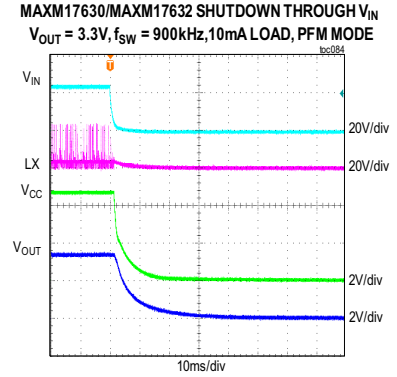
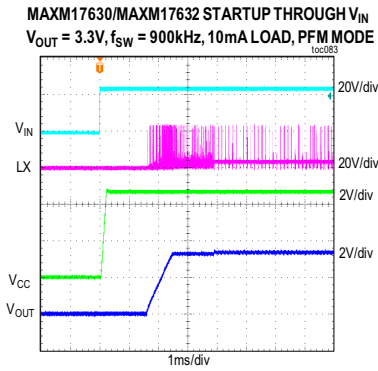
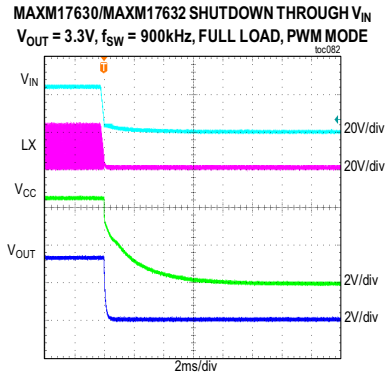

Typical Operating Characteristics (continued)

($V_{EN/UVLO} = V_{IN} = 24V$, $V_{SGND} = V_{PGND} = 0V$, $C_{VCC} = 2.2\mu F$, $C_{BST} = 0.1\mu F$, $C_{SS} = 5600pF$, $T_A = -40^{\circ}C$ to $+125^{\circ}C$, unless otherwise noted. Typical values are at $T_A = +25^{\circ}C$. All voltages are referenced to SGND, unless otherwise noted.)

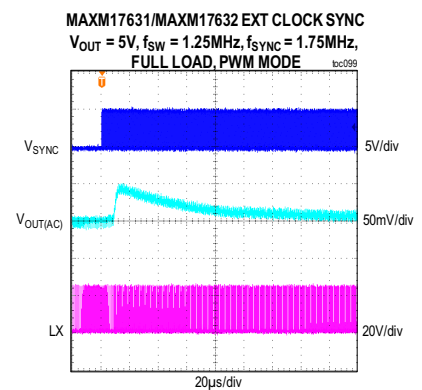
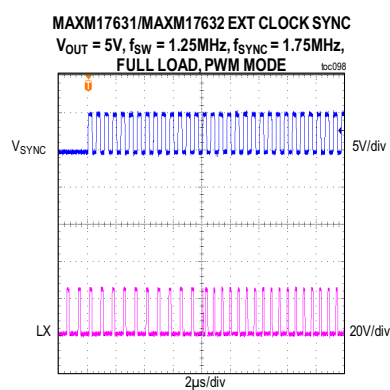
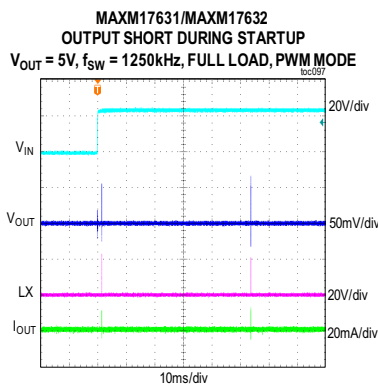
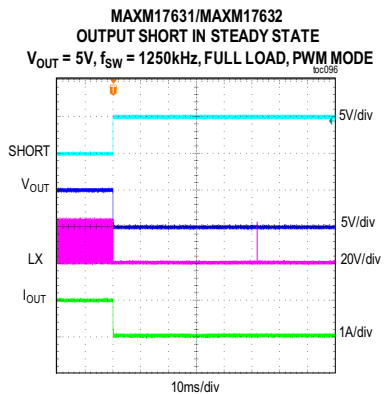
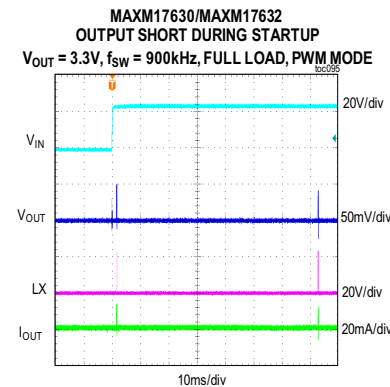
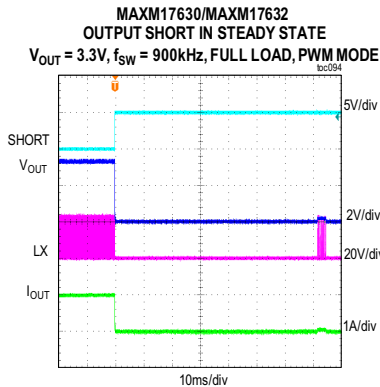
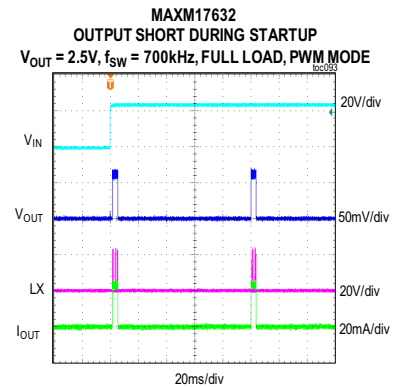
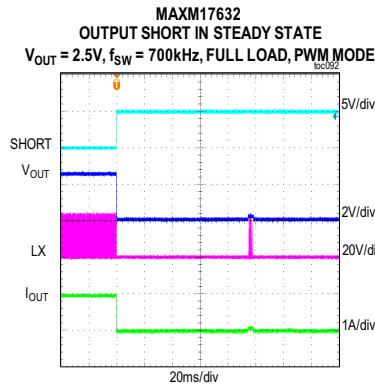
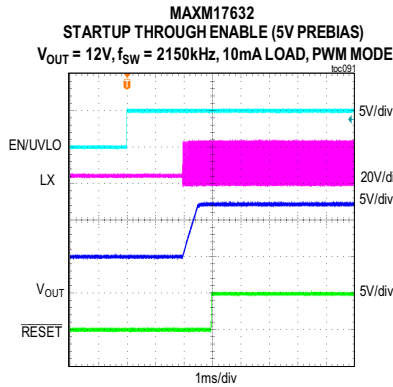

Typical Operating Characteristics (continued)

($V_{EN/UVLO} = V_{IN} = 24V$, $V_{SGND} = V_{PGND} = 0V$, $C_{VCC} = 2.2\mu F$, $C_{BST} = 0.1\mu F$, $C_{SS} = 5600pF$, $T_A = -40^\circ C$ to $+125^\circ C$, unless otherwise noted. Typical values are at $T_A = +25^\circ C$. All voltages are referenced to SGND, unless otherwise noted.)

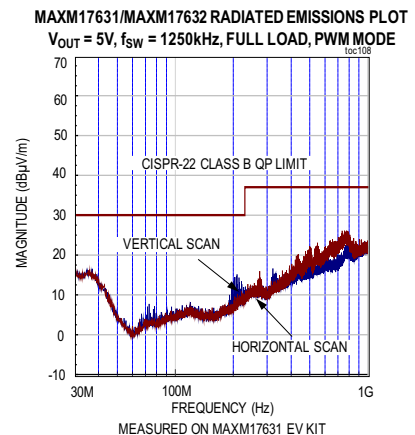
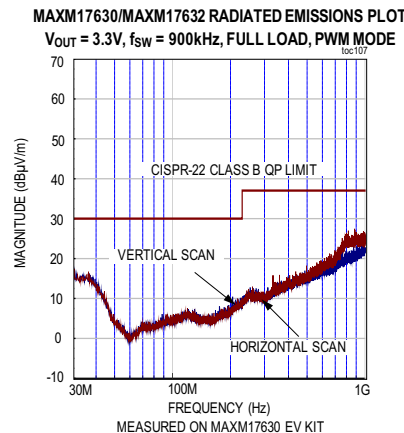
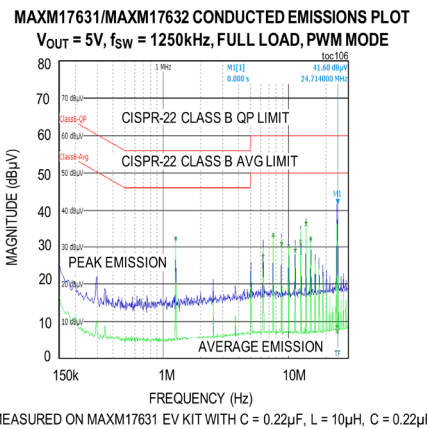
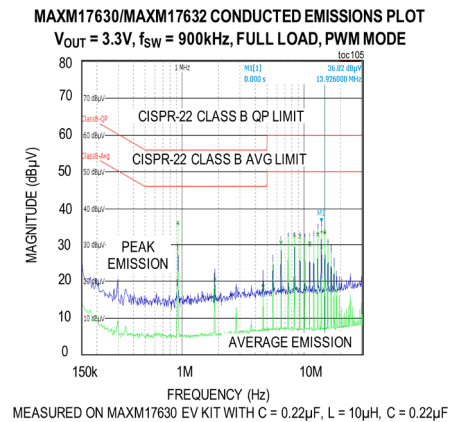
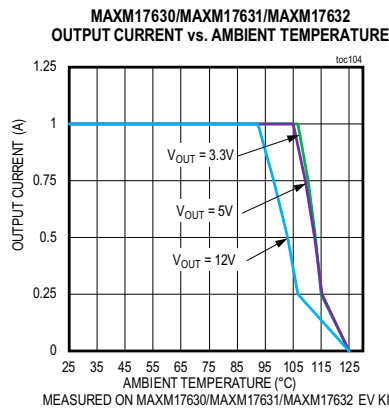
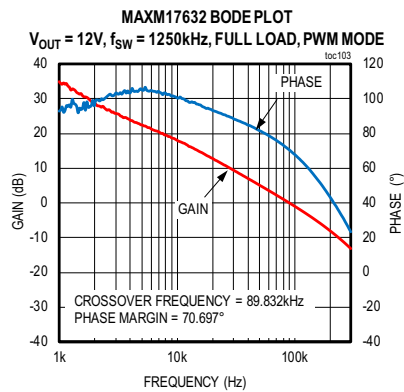
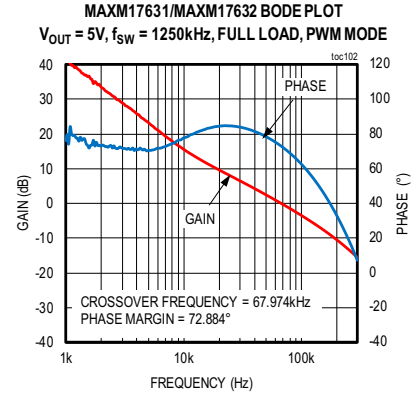
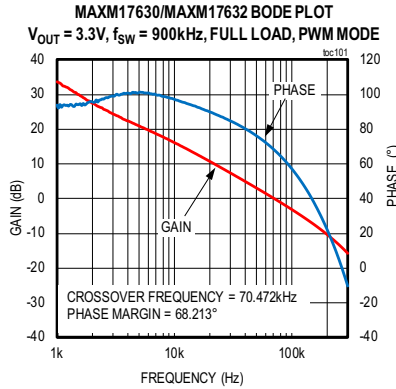
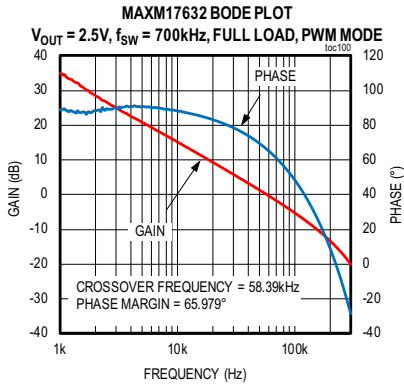

Pin Configuration

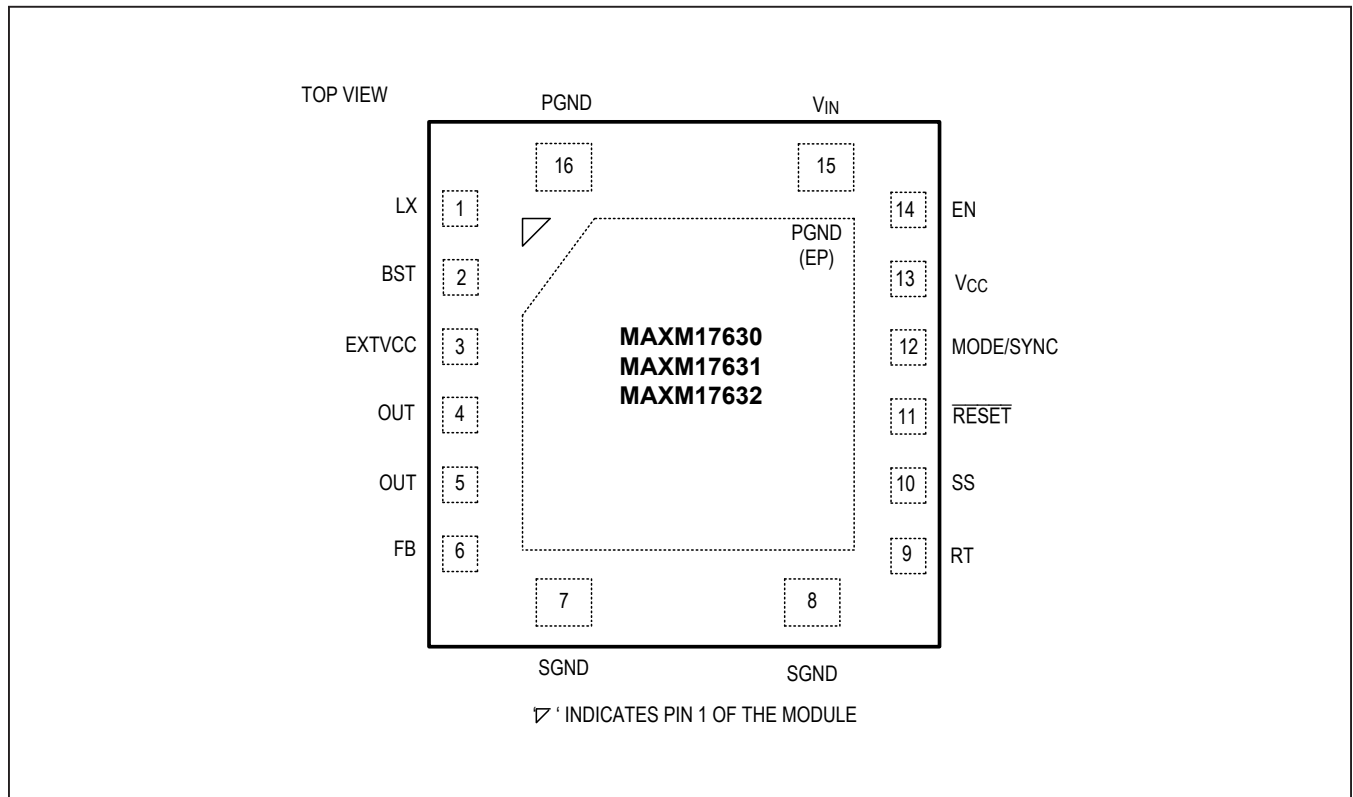

Pin Description

PIN	NAME	FUNCTION
1	LX	Switching node of the inductor. No external connection to this pin.
2	BST	Bootstrap Capacitor. Connect a 0.1µF ceramic capacitor between BST and LX.
3	EXTVCC	External Power Supply Input Reduces the Internal-LDO loss. Connect it to output when OUT is programmed to 5V only. When EXTVCC is not used, connect it to SGND.
4, 5	OUT	Module Output Pin. Connect a capacitor from OUT to GND. See the PCB Layout Guidelines section for more details.
6	FB	Feedback Input. Connect the output voltage node (V_{OUT}) to FB for MAXM17630 and MAXM17631. Connect FB to the center node of an external resistor-divider from the output to SGND to set the output voltage for MAXM17632. See the Output Voltage Setting section for more details.
7, 8	SGND	Analog Ground
9	RT	Switching Frequency Settings. Connect a resistor from RT to SGND to set the regulator's switching frequency between 400kHz and 2.2MHz. Leave RT open for the default 400kHz frequency. See the Setting the Switching Frequency (RT) section for more details.
10	SS	Soft-Start Input. Connect a capacitor from SS to SGND to set the soft-start time.

Pin Description (continued)

PIN	NAME	FUNCTION
11	$\overline{\text{RESET}}$	Open-Drain Power Good Output. The $\overline{\text{RESET}}$ output is driven low if FB drops below 92% of its set value. $\overline{\text{RESET}}$ goes high 1024 cycles after FB rises above 95% of its set value. See the Electrical Characteristics table for threshold values
12	MODE/SYNC	MODE/SYNC Pin Configures the Device to Operate either in PWM, PFM or DCM Modes of Operation. Leave MODE/SYNC open for PFM operation (pulse skipping at light loads). Connect MODE/SYNC to SGND for constant-frequency PWM operation at all loads. Connect MODE/SYNC to V_{CC} for DCM operation at light loads. The device can be synchronized to an external clock using this pin.
13	V_{CC}	5V LDO Output. Bypass V_{CC} with a 2.2 μF ceramic capacitor to SGND.
14	EN/UVLO	Enable/Undervoltage Lockout Pin. Drive EN/UVLO high to enable the output. Connect to the center of the resistor-divider between V_{IN} and SGND to set the input voltage at which the part turns on. Connect to the V_{IN} pin for always on operation. Pull low for disabling the device.
15	V_{IN}	Power-Supply Input Pin. 4.5V to 36V input-supply range. Decouple to PGND with a capacitor; place the capacitor close to the V_{IN} and PGND pins.
16	PGND	Power Ground Pin of the module. Connect externally to the power ground plane. Refer to the MAXM17630 Evaluation Kit (EV kit) data sheet for a layout example.
-	EP	Exposed Pad. Always connect EP to the PGND pin of the module. Also, connect EP to a large PGND plane with several thermal vias for best thermal performance. Refer to the MAXM17630 EV kit data sheet for an example of the correct method for EP connection and thermal vias.

Functional Diagrams

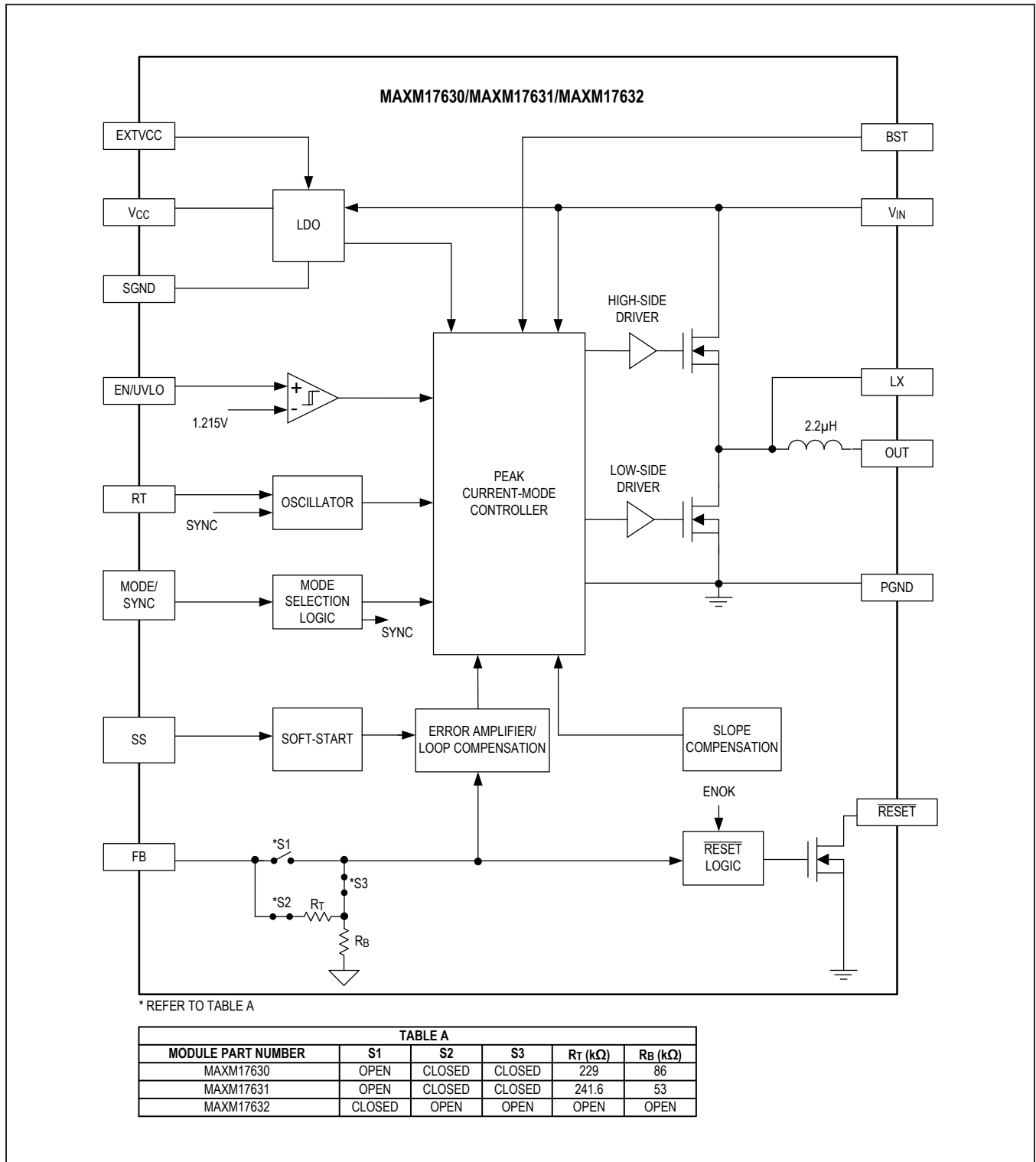

Detailed Description

The MAXM17630/MAXM17631/MAXM17632 are a family of high-efficiency, high voltage, synchronous step-down DC-DC modules with integrated controller, MOSFETs, compensation components, and inductor that operate over a wide input-voltage range of 4.5V to 36V. The modules can deliver up to 1A current. MAXM17630 and MAXM17631 are fixed 3.3V and fixed 5V output parts, respectively. MAXM17632 is the adjustable output voltage (0.9V to 12V) part. Built-in compensation across the output-voltage range eliminates the need for external compensation components. The feedback-voltage regulation accuracy over -40°C to $+125^{\circ}\text{C}$ is $\pm 1.2\%$ for MAXM17630/MAXM17631/MAXM17632.

The modules feature a peak-current-mode control architecture. An internal transconductance error amplifier produces an integrated error voltage at an internal node, which sets the duty cycle using a PWM comparator, a high-side current-sense amplifier, and a slope-compensation generator. At each rising edge of the clock, the high-side MOSFET turns on and remains on until either the appropriate or maximum duty cycle is reached, or the peak current limit is detected. During the high-side MOSFET on-time, the inductor current ramps up. During the second half of the switching cycle, the high-side MOSFET turns off and the low-side MOSFET turns on. The inductor releases the stored energy as its current ramps down and provides current to the output.

The module features a MODE/SYNC pin that can be used to operate the device in PWM, or PFM, or DCM control modes. The module integrates adjustable-input undervoltage lockout, adjustable soft-start, open-drain $\overline{\text{RESET}}$, and external frequency synchronization features.

Mode Selection and External Synchronization (MODE/SYNC)

The MAXM17630/MAXM17631/MAXM17632 support PWM, PFM, and DCM mode of operation. The device enters the required mode of operation based on the setting of the MODE/SYNC pin as detected within 1.5ms after V_{CC} and EN/UVLO voltages exceed their respective UVLO rising thresholds ($V_{\text{CC-UVR}}$, and V_{ENR}). If the MODE/SYNC pin is open, the module operates in PFM mode at light loads. If the state of the MODE/SYNC pin is low ($< V_{\text{M-PWM}}$), the module operates in constant-frequency PWM mode at all loads. If the state of the MODE/SYNC pin is high ($> V_{\text{M-DCM}}$), the module operates in DCM mode at light loads.

During external clock synchronization, the module operates in PWM mode irrespective of the mode of operation detected. When 16 external clock rising edges are detected on the MODE/SYNC pin, the internal oscillator frequency set by the RT pin (f_{SW}) changes to the external clock frequency, and the device transitions to PWM mode. The device remains in PWM mode until EN/UVLO or input power is cycled. The external clock frequency must be between $1.1 \times f_{\text{SW}}$ and $1.4 \times f_{\text{SW}}$. The minimum external clock pulse width should be greater than 50ns. The off-time duration of the external clock should be at least 160ns. See the MODE/SYNC section in the [Electrical Characteristics](#) table for details.

PWM Operation

In PWM mode, the internal inductor current is allowed to go negative. PWM operation is useful in frequency sensitive applications and provides fixed switching frequency operation at all loads. However, PWM mode gives lower efficiency at light loads compared to PFM and DCM modes of operation.

PFM Operation

PFM mode disables negative output current in the inductor, and additionally skips pulses at light loads for better efficiency. In PFM mode, the inductor current is forced to a fixed peak of 700mA in every clock cycle until the output voltage rises to 102.3% of the nominal value. Once the output voltage reaches 102.3% of the nominal value, the high-side switch is turned OFF and the low-side switch is turned ON. Once the inductor current hits zero cross, LX goes to a high impedance state and the module enters hibernate operation until the load current discharges the output voltage to 101.1% of the nominal value. Most of the internal blocks are turned OFF in hibernate operation to save quiescent current. When the output voltage falls below 101.1% of the nominal value, the module comes out of hibernate operation, turns on all internal blocks, and commences the process of delivering pulses of energy until the output voltage reaches 102.3% of the nominal value. The module naturally comes out of PFM mode and serves load requirements when the module output demands more than 700mA peak. The advantage of PFM mode is higher efficiency at light loads because of lower quiescent current drawn from supply. The disadvantage is that the output-voltage ripple is higher compared to PWM or DCM modes of operation and switching frequency is not constant at light loads.

DCM Operation

DCM mode of operation features constant frequency operation down to lighter loads than PFM mode by disabling negative inductor current at light loads. DCM operation offers efficiency performance that lies between PWM and PFM modes. The output-voltage ripple in DCM mode is comparable to PWM mode and relatively lower compared to PFM mode.

Linear Regulator (V_{CC} and EXT_{VCC})

The module has an internal low dropout (LDO) regulator that powers V_{CC} from V_{IN}. This LDO is enabled during power-up or when EN/UVLO is recycled. When V_{CC} is above its UVLO, if EXT_{VCC} is greater than 4.7V (typ), internal V_{CC} is powered by EXT_{VCC} and LDO is disabled from V_{IN}. Powering V_{CC} from EXT_{VCC} increases efficiency at higher input voltages. The typical V_{CC} output voltage is 5V. Bypass V_{CC} to SGND with a 2.2µF low-ESR ceramic capacitor. V_{CC} powers the internal blocks and the low-side MOSFET driver and recharges the external bootstrap capacitor.

The module employs an undervoltage-lockout circuit that forces the regulator off when V_{CC} falls below V_{CC_UVF}. The regulator can be immediately enabled again when V_{CC} > V_{CC_UVR}. The 400mV UVLO hysteresis prevents chattering on power-up/power-down.

In applications where the buck-converter output is connected to the EXT_{VCC} pin, if the output is shorted to ground, then the transfer from EXT_{VCC} to internal LDO happens seamlessly without any impact to the normal functionality. Connect the EXT_{VCC} pin to SGND when not in use.

Setting the Switching Frequency (RT)

The switching frequency of the module can be programmed from 400kHz to 2.2MHz by using a resistor connected from the RT pin to SGND. The switching frequency (f_{SW}) is related to the resistor connected at the RT pin (R_{RT}) by the following equation:

$$R_{RT} = \frac{21000}{f_{SW}} - 1.7$$

Where R_{RT} is in kΩ and f_{SW} is in kHz. Leaving the RT pin open makes the module operate at the default switching frequency of 400kHz. See [Table 1](#) for RT resistor values for a few common switching frequencies.

Table 1. Switching Frequency vs. RT Resistor

SWITCHING FREQUENCY (kHz)	RT RESISTOR (kΩ)
400	OPEN
400	50.8
500	40.2
2200	8.06

RESET Output ($\overline{\text{RESET}}$)

The module includes an open-drain $\overline{\text{RESET}}$ output to monitor the output voltage. The open-drain $\overline{\text{RESET}}$ output requires an external pullup resistor. $\overline{\text{RESET}}$ goes high (high impedance) 1024 switching cycles after the regulator output increases above 95% of the designed nominal regulated voltage. $\overline{\text{RESET}}$ goes low when the regulator output voltage drops below 92% of the nominal regulated voltage. $\overline{\text{RESET}}$ also goes low during thermal shutdown or when the EN/UVLO pin goes below V_{ENF}.

Prebiased Output

When the module starts into a prebiased output, both the high-side and the low-side switches are turned off so that the module does not sink current from the output. High-side and low-side switches do not start switching until the PWM comparator commands the first PWM pulse, at which point switching commences. The output voltage is then smoothly ramped up to the target value in alignment with the internal reference.

Overcurrent Protection (OCP)/Hiccup Mode

The MAXM17630/MAXM17631/MAXM17632 are provided with a robust overcurrent protection (OCP) scheme that protects the modules under overload and output short-circuit conditions. The power module measures and limits peak inductor current. When overcurrent is detected in the inductor, or if the feedback voltage drops to V_{FB-HICF} any time after soft-start is complete, the module enters hiccup mode of operation. In hiccup mode, the converter is protected by suspending switching for a hiccup timeout period of 32,768 clock cycles of half the programmed switching frequency. Once the hiccup timeout period expires, soft-start is attempted again. Note that when soft-start is attempted under overload condition, if feedback voltage does not exceed V_{FB-HICF}, the device continues to switch at half the programmed switching frequency for the time duration of the programmed soft-start time and 1024 clock cycles. Hiccup mode of operation ensures low power dissipation under output overload or short-circuit conditions.

MAXM17630/MAXM17631/ MAXM17632

4.5V to 36V, 1A Himalaya uSLIC Step-Down Power Module

The MAXM17630/MAXM17631/MAXM17632 are designed to support a maximum load current of 1A. The inductor ripple current is calculated as follows:

$$\Delta I = \left[\frac{V_{IN} - V_{OUT} - 0.332 \times I_{OUT}}{L \times f_{SW}} \right] \times \left[\frac{V_{OUT} + 0.242 \times I_{OUT}}{V_{IN} - 0.09 \times I_{OUT}} \right]$$

where:

V_{OUT} = Steady-state output voltage

V_{IN} = Operating input voltage for given V_{OUT}

f_{SW} = Switching Frequency in Hz

L = Power module output inductance (2.2 μ H \pm 30%) in μ H

I_{OUT} = Required output (load) current

The following condition should be satisfied at the desired load current, I_{OUT} .

$$I_{OUT} + \frac{\Delta I}{2} < 2.32$$

Thermal Overload Protection

Thermal overload protection limits the total power dissipation in the device. When the junction temperature exceeds +165°C, an on-chip thermal sensor shuts down the device, turns off the internal power MOSFETs, allowing the device to cool down. The thermal sensor turns the device on after the junction temperature cools by 10°C. Soft-start resets during thermal shutdown.

Applications Information

Input-Voltage Range

The minimum and maximum operating input voltages for a given output voltage is calculated as follows:

$$V_{IN(MIN)} = \frac{V_{OUT} + (I_{OUT} \times 0.242)}{1 - (f_{SW(MAX)} \times t_{OFF-MIN(MAX)})} + (I_{OUT} \times 0.09)$$

$$V_{IN(MAX)} = \frac{V_{OUT}}{t_{ON-MIN(MAX)} \times f_{SW(MAX)}}$$

where:

V_{OUT} = Steady-state output voltage

I_{OUT} = Maximum load current

$f_{SW(MAX)}$ = Maximum switching frequency in Hz

$t_{OFF-MIN(MAX)}$ = Worst Case minimum switch off-time (160ns)

$t_{ON-MIN(MAX)}$ = Worst case minimum switch on-time (80ns).

Also, for duty cycle > 0.5

$$V_{IN(MIN)} > ((3.09 \times V_{OUT}) + (0.84 \times I_{OUT}) - (\frac{4.2m \times f_{SW}}{500}))$$

where f_{SW} = Switching frequency in Hz

Selection of Input Capacitor

The input filter capacitor reduces peak currents drawn from the power source and reduces noise and voltage ripple on the input caused by the converter switching.

The input capacitor RMS current requirement (I_{RMS}) is defined by the following equation:

$$I_{RMS} = I_{OUT(MAX)} \times \sqrt{\frac{V_{OUT} \times (V_{IN} - V_{OUT})}{V_{IN}}}$$

where $I_{OUT(MAX)}$ is the maximum load current. I_{RMS} has a maximum value when the input voltage equals twice the output voltage ($V_{IN} = 2 \times V_{OUT}$).

$$\text{So, } I_{RMS(MAX)} = \frac{I_{OUT(MAX)}}{2}$$

Choose an input capacitor that exhibits less than +10°C temperature rise at the RMS input current for optimal long-term reliability. Use low-ESR ceramic capacitors with high-ripple-current capability at the input. X7R capacitors are recommended in industrial applications for their temperature stability. Calculate the input capacitance using the following equation:

$$C_{IN} = \frac{I_{OUT(MAX)} \times D_{MAX} \times (1 - D_{MAX})}{f_{SW} \times \Delta V_{IN}}$$

where

D_{MAX} = Maximum duty cycle

f_{SW} = Switching frequency

ΔV_{IN} = Allowable input voltage ripple

In applications where the source is located distant from the device input, an appropriate electrolytic capacitor should be added in parallel to the ceramic capacitor to provide necessary damping for potential oscillations caused by the inductance of the longer input power path and input ceramic capacitor.

Selection of Output Capacitor

X7R ceramic output capacitors are preferred due to their stability over temperature in industrial applications. The output capacitor has two functions. It provides smooth voltage and, stores sufficient energy to support the output voltage under load transient conditions and stabilizes the device's internal control loop. Usually the output capacitor is sized to support a step load of 50% of the maximum output current in the application, such that the output-voltage deviation is less than 3%. The minimum required output capacitance can be calculated as follows:

$$C_{OUT} = \frac{1}{2} \times \frac{I_{STEP} \times t_{RESPONSE}}{\Delta V_{OUT}}$$

$$t_{RESPONSE} \cong \frac{0.33}{f_C} + \frac{1}{f_{SW}}$$

where:

I_{STEP} = Load current step

$t_{RESPONSE}$ = Response time of the controller

ΔV_{OUT} = Allowable output-voltage deviation

f_C = Target closed-loop crossover frequency

f_{SW} = Switching frequency.

Select f_C to be 1/10th of f_{SW} if the switching frequency is less than or equal to 800kHz. If the switching frequency is more than 800kHz, select f_C to be 80kHz. Actual derating of ceramic capacitors with DC-voltage must be considered while selecting the output capacitor. Derating curves are available from all major ceramic capacitor vendors.

Selection of Soft-Start Capacitor

The device implements adjustable soft-start operation to reduce inrush current. A capacitor connected from the SS pin to SGND programs the soft-start time. The selected output capacitance (C_{SEL}) and the output voltage (V_{OUT}) determine the minimum required soft-start capacitor as follows:

$$C_{SS} \geq 28 \times 10^{-6} \times C_{SEL} \times V_{OUT}$$

The soft-start time (t_{SS}) is related to the capacitor connected at SS (C_{SS}) by the following equation:

$$t_{SS} = \frac{C_{SS}}{5.55 \times 10^{-6}}$$

For example, to program a 1ms soft-start time, a 5.6nF capacitor should be connected from the SS pin to SGND. Note that during startup, the device operates at half the programmed switching frequency until the output voltage reaches 64.4% of output nominal voltage.

Setting the Input Undervoltage-Lockout Level

The devices offer an adjustable input undervoltage lockout level. Set the voltage at which the device turns on with a resistive voltage-divider connected from V_{IN} to SGND (see [Figure 1](#)). Connect the center node of the divider to EN/UVLO.

Choose R4 to be 3.3M Ω (max) and then calculate R5 as follows:

$$R5 = \frac{R4 \times 1.215}{(V_{INU} - 1.215)}$$

where V_{INU} is the voltage at which the device is required to turn on. Ensure that V_{INU} is higher than $0.8 \times V_{OUT}$.

If the EN/UVLO pin is driven from an external signal source, a series resistance of minimum 1k Ω is recommended to be placed between the signal source output and the EN/UVLO pin to reduce voltage ringing on the line.

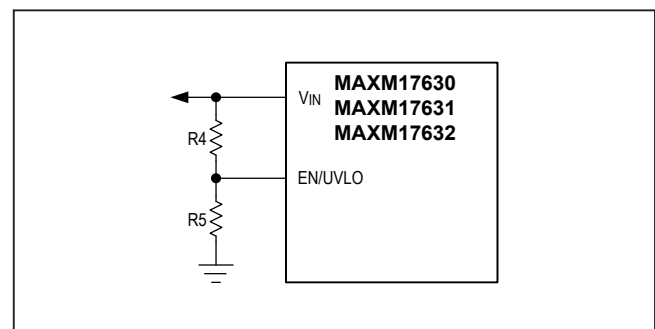

Figure 1. Adjustable EN/UVLO Network

Output Voltage Setting

Set the output voltage with a resistive voltage-divider connected from the output-voltage node OUT to SGND (see [Figure 2](#)). Connect the center node of the divider to the FB pin for MAXM17632. Connect the output voltage node (OUT) to the FB pin for MAXM17630 and MAXM17631 (see [Figure 3](#)). Use the following procedure to choose the resistive voltage-divider values.

Calculate resistor R2 from the output to the FB pin as follows:

$$R2 = \frac{255}{(f_c \times C_{OUT})}$$

where:

R2 is in kΩ

f_c = Crossover frequency is in Hz

C_{OUT} = Actual capacitance of selected output capacitor at DC-bias voltage in F.

Calculate resistor R3 from FB pin to SGND as follows:

$$R3 = \frac{R2 \times 0.9}{V_{OUT} - 0.9}$$

where, R3 is in kΩ and V_{OUT} equals the target output voltage.

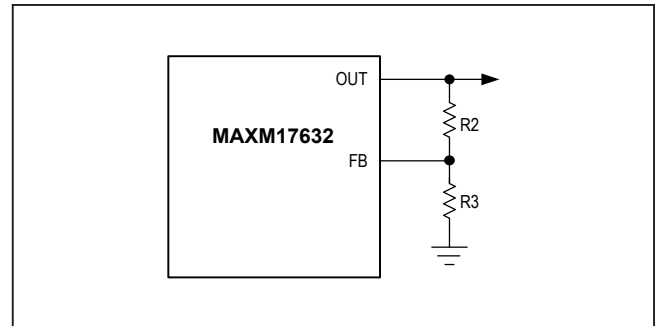

Figure 2. Setting Adjustable Output Voltage

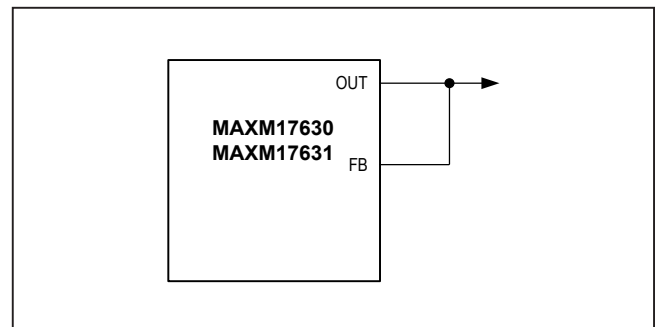

Figure 3. Setting Fixed Output Voltage

Table 2. Components selection for MAXM17630/MAXM17631/MAXM17632

PART NUMBER	V _{IN(MIN)} (V)	V _{IN(MAX)} (V)	V _{OUT} (V)	C _{IN}	C _{OUT}	R _T (kΩ)	R ₂ (kΩ)	R ₃ (kΩ)	f _{sw} (kHz)
MAXM17630	4.5	36	3.3	1 x 4.7μF 1206 50V (Murata GRM-31CR71H475KA12#)	1 x 22μF 1210 25V (Murata GRM32ER-71E226KE15#)	21.5	N/A	N/A	900
MAXM17631	7	36	5	1 x 4.7μF 1206 50V (Murata GRM-31CR71H475KA12#)	1 x 22μF 1210 25V (Murata GRM32ER-71E226KE15#)	15.00	N/A	N/A	1250

Table 2. Components selection for MAXM17630/MAXM17631/MAXM17632 (continued)

PART NUMBER	V _{IN(MIN)} (V)	V _{IN(MAX)} (V)	V _{OUT} (V)	C _{IN}	C _{OUT}	RT (kΩ)	R2 (kΩ)	R3 (kΩ)	f _{SW} (kHz)
MAXM17632	4.5	26.5	0.9	1 x 4.7μF 1206 50V (Murata GRM-31CR71H475KA12#)	3 x 47μF 1210 10V (Murata GRM32ER-71A476KE15#)	OPEN	69.8	OPEN	400
	4.5	35.5	1.2	1 x 4.7μF 1206 50V (Murata GRM-31CR71H475KA12#)	3 x 47μF 1210 10V (Murata GRM32ER-71A476KE15#)	OPEN	69.8	210	400
	4.5	36	1.5	1 x 4.7μF 1206 50V (Murata GRM-31CR71H475KA12#)	2 x 47μF 1210 10V (Murata GRM32ER-71A476KE15#)	42.20	90.9	137	480
	4.5	36	1.8	1 x 4.7μF 1206 50V (Murata GRM-31CR71H475KA12#)	2 x 47μF 1210 10V (Murata GRM32ER-71A476KE15#)	40.2	90.9	90.9	500
	4.5	36	2.5	1 x 4.7μF 1206 50V (Murata GRM-31CR71H475KA12#)	1 x 47μF 1210 10V (Murata GRM32ER-71A476KE15#)	28.40	137	76.8	700
	4.5	36	3.3	1 x 4.7μF 1206 50V (Murata GRM-31CR71H475KA12#)	1 x 22μF 1210 25V (Murata GRM32ER-71E226KE15#)	21.5	229	88.7	900
	7	36	5	1 x 4.7μF 1206 50V (Murata GRM-31CR71H475KA12#)	1 x 22μF 1210 25V (Murata GRM32ER-71E226KE15#)	15.00	261	56	1250
	20	36	12	1 x 4.7μF 1206 50V (Murata GRM-31CR71H475KA12#)	1 x 10μF 1210 50V (Murata GRM32ER-71H106KA12#)	8.20	634	51	2150

The MAXM17630/MAXM17631/MAXM17632 has a pulse skip algorithm that allows V_{OUT} to be regulated when the operating input voltage is beyond the V_{IN(MAX)} specified in the above table up to 36V.

Power dissipation

The power dissipation inside the module leads to an increase in the junction temperature of the MAXM17630/MAXM17631/MAXM17632. The power loss inside the module at full load can be estimated as follows:

$$P_{\text{LOSS}} = P_{\text{OUT}} \times \left(\frac{1}{\eta} - 1\right)$$

Where η is the efficiency of the power module at the desired operating conditions. The junction temperature (T_J) of the module can be estimated at any given maximum ambient temperature (T_A) from the following equation:

$$T_J = T_A + [\theta_{JA} \times P_{\text{LOSS}}]$$

For the MAXM17630/MAXM17631/MAXM17632 evaluation board, the thermal resistance from junction-to-ambient (θ_{JA}) is 28°C/W. Operating the module at junction temperatures greater than +125°C degrades operating lifetimes. See the [Typical Operating Characteristics](#) for

the power-conversion efficiency, or measure the efficiency to determine the total power dissipation. An EE-SIM model is available for the MAXM17630/MAXM17631/MAXM17632 to simulate efficiency and power loss for the desired operating conditions.

PCB Layout Guidelines

Use the following guidelines for good PCB layout:

- Keep the input capacitors as close as possible to the IN and GND pins.
- Keep the output capacitors as close as possible to the OUT and GND pins.
- Keep the resistive feedback dividers as close as possible to the FB pin.
- Keep the power traces and load connections short.

Refer to the MAXM17630/MAXM17631/MAXM17632 EV kit layout for first pass success.

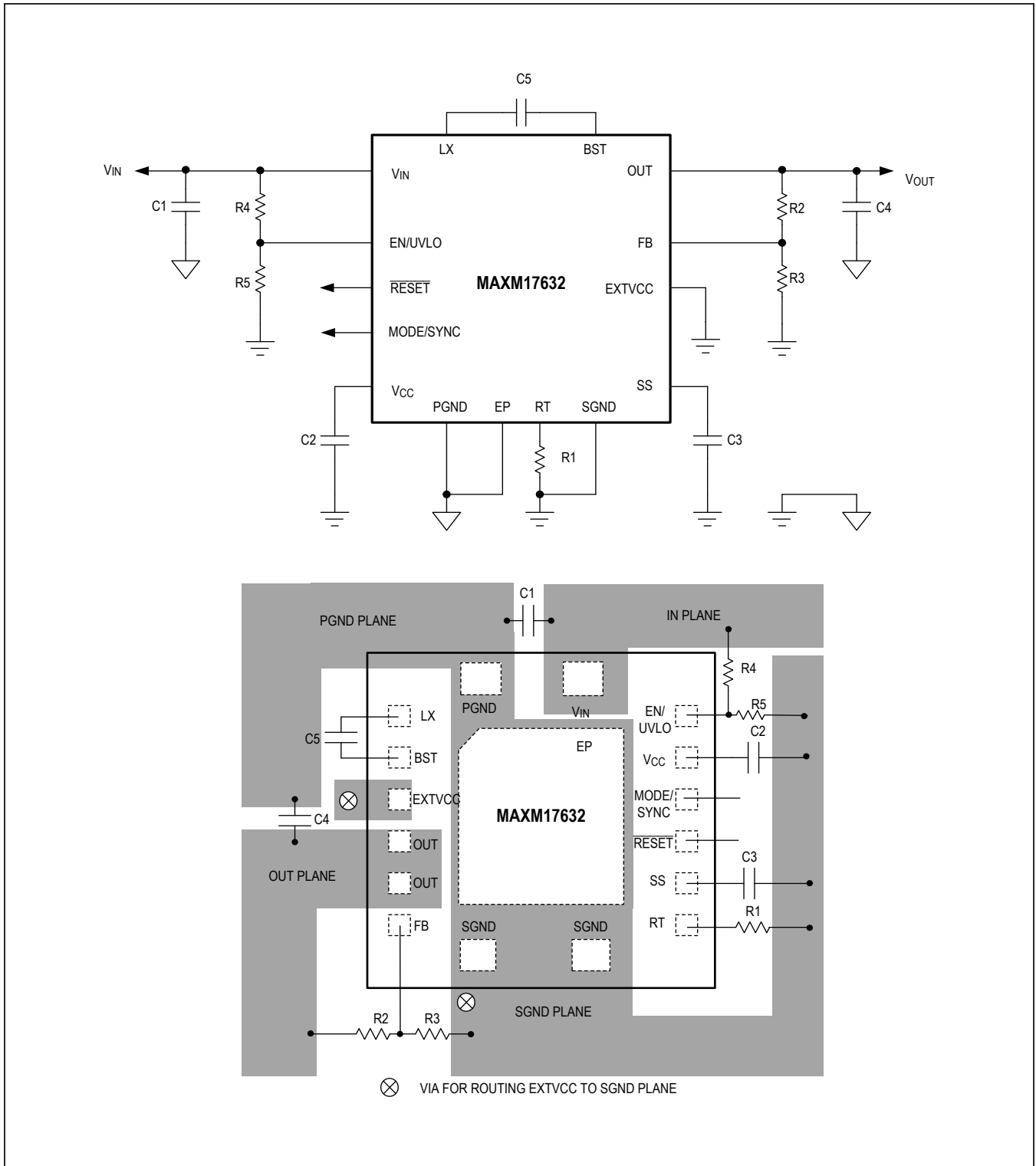

Figure 4. Adjustable Output Layout Guidelines

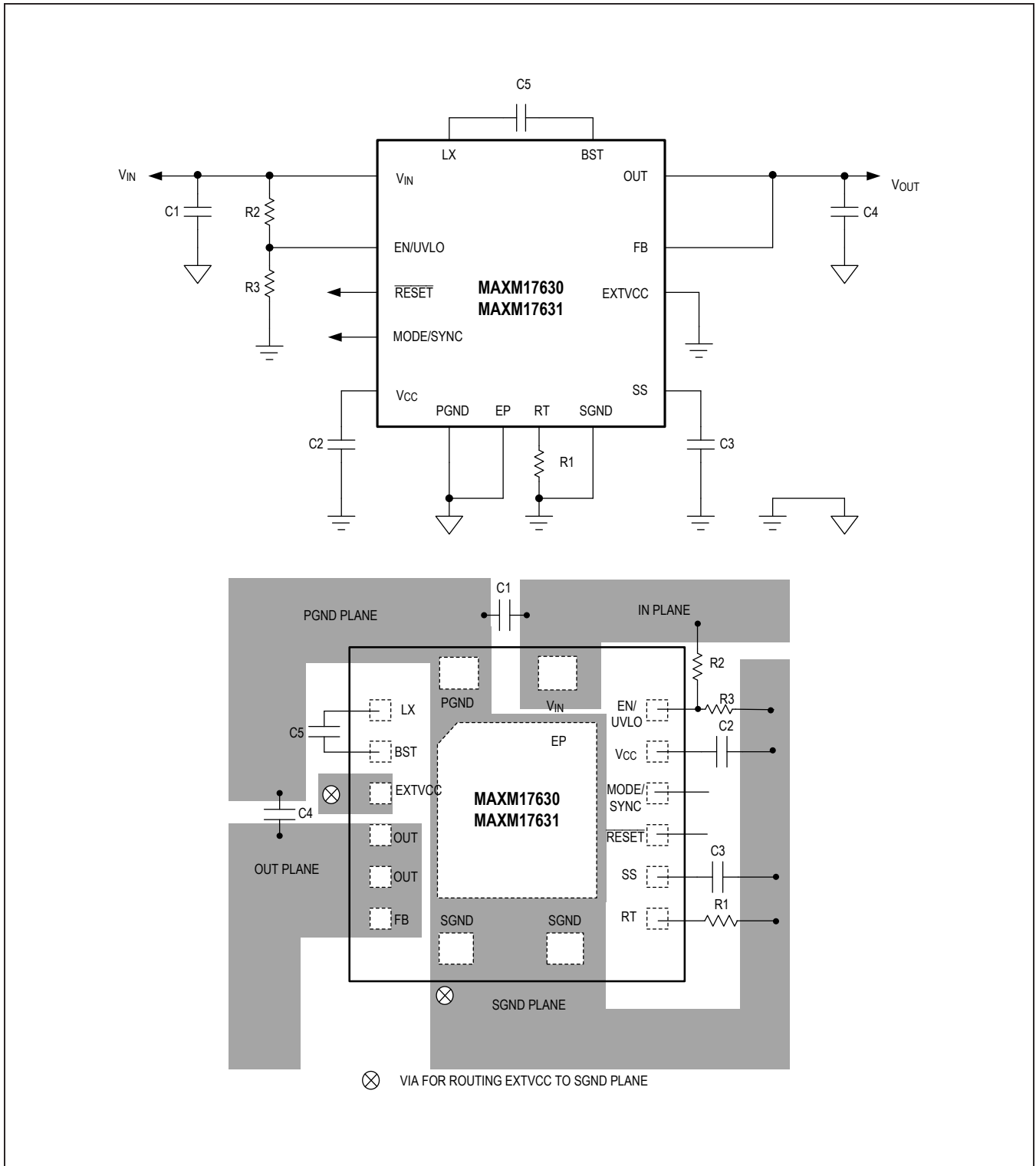
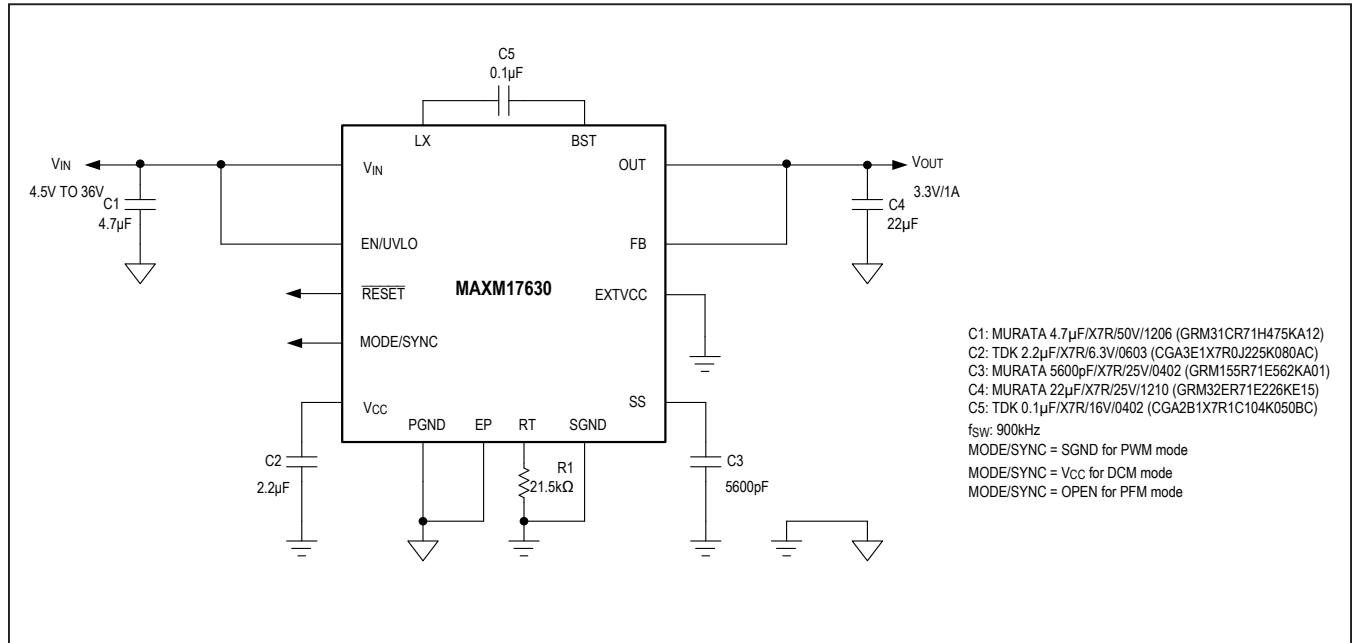

Figure 5. Fixed Output Layout Guidelines

Typical Application Circuits

Typical Application Circuit for Fixed 3.3V Output



Typical Application Circuit for Fixed 5V output

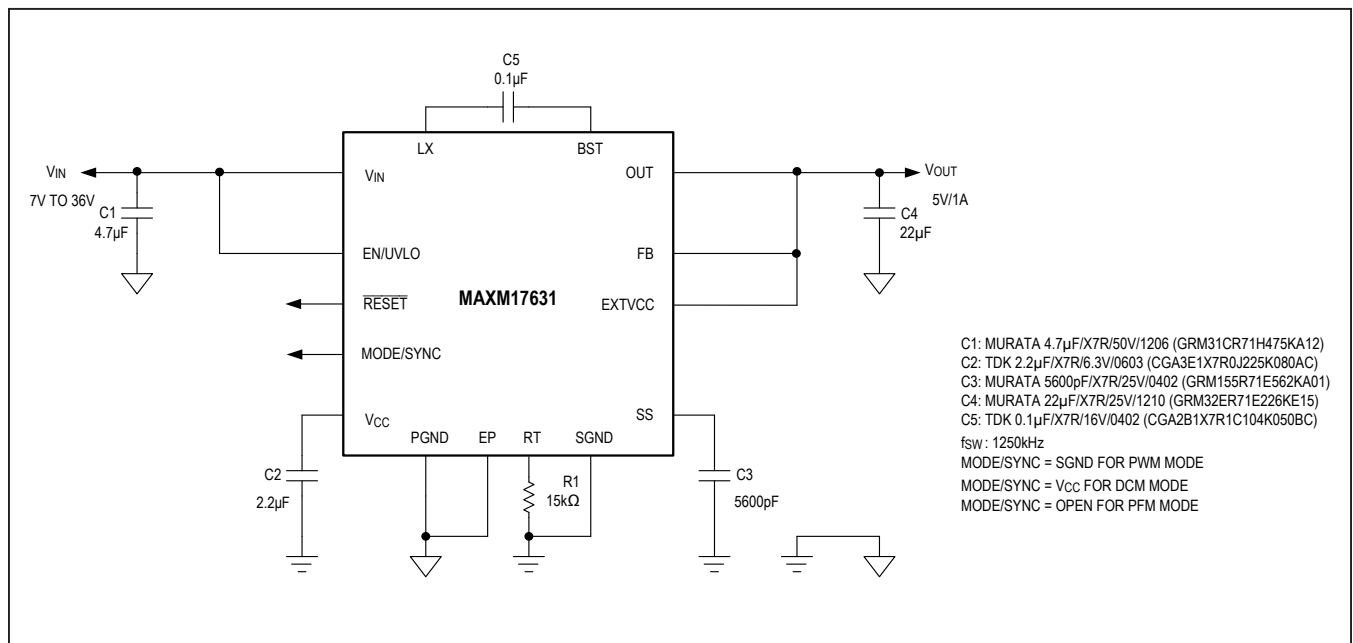

Typical Application Circuits (continued)

Typical Application Circuit for Adjustable 2.5V OUTPUT

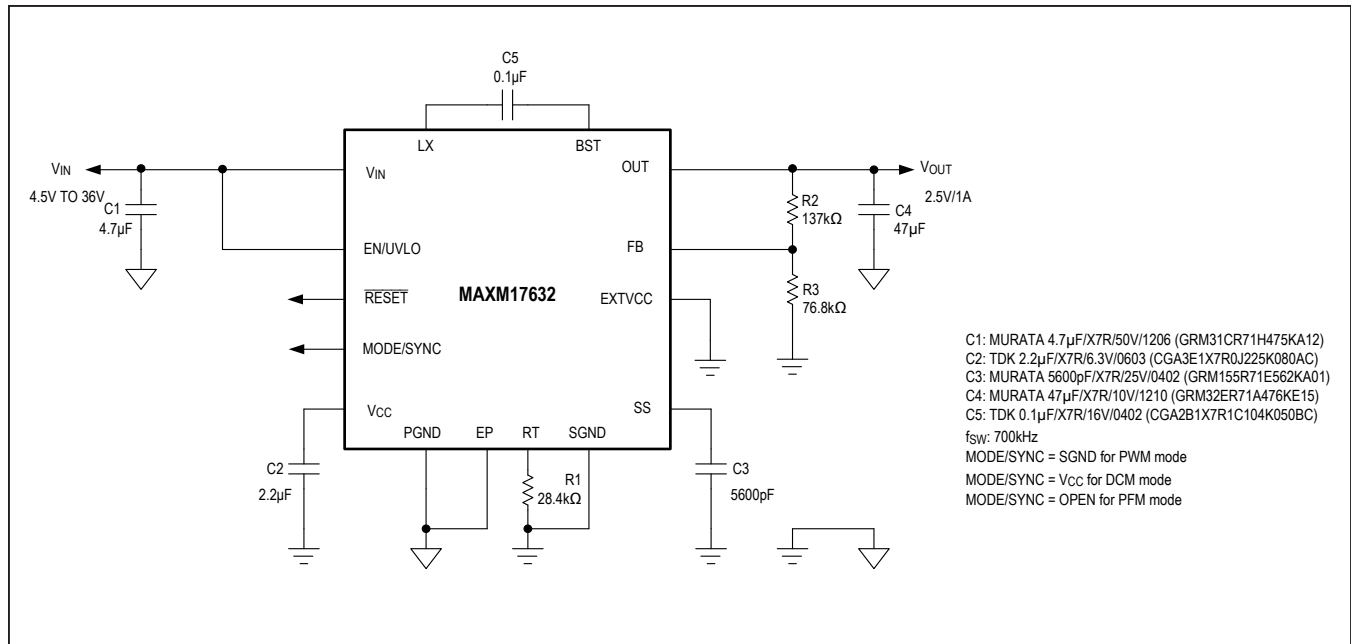

Typical Application Circuit for Adjustable 12V Output

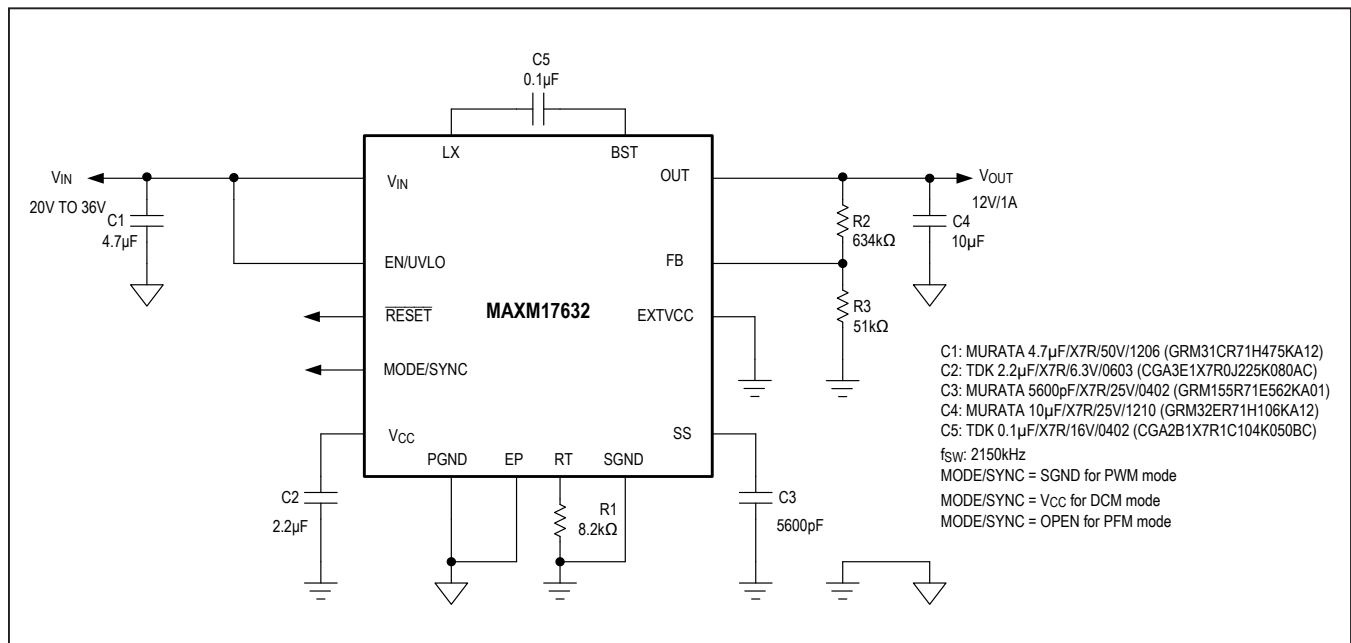

MAXM17630/MAXM17631/
MAXM17632

4.5V to 36V, 1A Himalaya uSLIC
Step-Down Power Module

Ordering Information

PART NUMBER	TEMP RANGE	OUTPUT VOLTAGE (V)	PIN-PACKAGE
MAXM17630AME+	-40°C to +125°C	3.3	16-pin uSLIC
MAXM17630AME+T	-40°C to +125°C	3.3	16-pin uSLIC
MAXM17631AME+	-40°C to +125°C	5	16-pin uSLIC
MAXM17631AME+T	-40°C to +125°C	5	16-pin uSLIC
MAXM17632AME+	-40°C to +125°C	Adjustable	16-pin uSLIC
MAXM17632AME+T	-40°C to +125°C	Adjustable	16-pin uSLIC

+ Denotes a lead(Pb)-free/RoHS-compliant package.

T = Tape and reel.

MAXM17630/MAXM17631/
MAXM17632

4.5V to 36V, 1A Himalaya uSLIC
Step-Down Power Module

Revision History

REVISION NUMBER	REVISION DATE	DESCRIPTION	PAGES CHANGED
0	7/19	Initial release	—
1	10/19	Removed future product designation from MAXM17632AME+ and MAXM17632AME+T in the <i>Ordering Information</i> table	31
1.1		Corrected typo in the <i>General Description</i> section	1

For pricing, delivery, and ordering information, please visit Maxim Integrated's online storefront at <https://www.maximintegrated.com/en/storefront/storefront.html>.

Maxim Integrated cannot assume responsibility for use of any circuitry other than circuitry entirely embodied in a Maxim Integrated product. No circuit patent licenses are implied. Maxim Integrated reserves the right to change the circuitry and specifications without notice at any time. The parametric values (min and max limits) shown in the Electrical Characteristics table are guaranteed. Other parametric values quoted in this data sheet are provided for guidance.

Mouser Electronics

Authorized Distributor

Click to View Pricing, Inventory, Delivery & Lifecycle Information:

[MAXM17630AME+](#) [MAXM17630AME+T](#)