

AFBR-POC306A1

Optical Power Converter

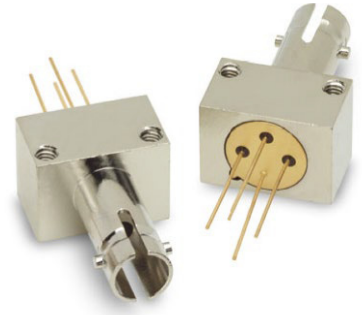

Description

The AFBR-POC306A1 belongs to the Broadcom[®] Power Components product family. The device converts optical power to electrical power for applications that require complete electrical isolation in highly demanding industrial environments and applications. The AFBR-POC306A1 is an excellent choice for powering electronic circuitry where electrical wired solutions are not feasible due to high voltage, electromagnetic interference, or strong magnetic fields.

The AFBR-POC306A1 is based on a patented multijunction compound semiconductor device that is optimized for an optical input wavelength range of 800 nm to 830 nm. Its output voltage is above 5 VDC for a wide range of applications.

Up to 3 watts of electrical power can be delivered by converting the optical input power provided over optical fiber from a high-power laser diode. The optical power converter features a nearly linear response to the optical input over a wide temperature range.

Smart thermal design simplifies system integration.

The AFBR-POC306A1 is optimized for integration with efficient coupling of multimode (MM) fibers with numerical apertures ranging from 0.22 to 0.27 and with typical core diameters of 62.5 μm to 400 μm .

Features

- Fully isolated Power over Fiber (PoF) solution that efficiently converts optical power to electrical power
- Supplies up to 3W of electrical power
- Optical energy conversion efficiencies over 50%
- Operating temperature range of -40°C to $+85^{\circ}\text{C}$.
- Easy heat-sink mounting for thermal management
- RoHS compliant

Applications

Typical fields of application of the optical power converter include the following:

- Fully galvanically isolated power supply without capacitive coupling, suitable for gate drivers
- Isolation transformer for MRI/RF imaging without the need for filters
- Optically isolated probes for power electronics with a wider dynamic range than any conventional probe
- Power source for tethered drones, enabling a higher payload and eliminating the need for battery charging
- Sensors where power must be immune to EMI, high voltage, and magnetic fields

Package

The AFBR-POC306A1 is packaged in a solid brass housing suitable for board mounting with standard heat-sink technology for thermal management.

The RoHS-compliance package can be integrated with various solutions.

The AFBR-POC306A1 allows for easy board mount integration with flexible geometries for fast and secure connection to standard ST optical connector strategies.

Handling Information

CAUTION! The p-n junctions in the design of these components increase the components' susceptibility to damage from electrostatic discharge (ESD). Take appropriate static precautions in handling and assembling these components to prevent damage, degradation, or both that may be induced by ESD.

- Good system performance requires clean port optics and cable ferrules to avoid obstructing the optical path. The optic components are hermetically sealed in a TO header with a glass window.
- Any particles of dirt in the optical path can reduce the conversion efficiency.
- Do not attempt to focus the input light onto the device surface. This could burn and irreversibly damage the device.
- As a general rule, it is recommended to attach the photo-converter units to the board after soldering the other components.
- *The AFBR-POC306A1 is a photovoltaic device.*
- *Do not apply external voltage to the device.*

Mechanical Dimensions – ST Port

Figure 1: AFBR-POC3xxAx (4 Pins)

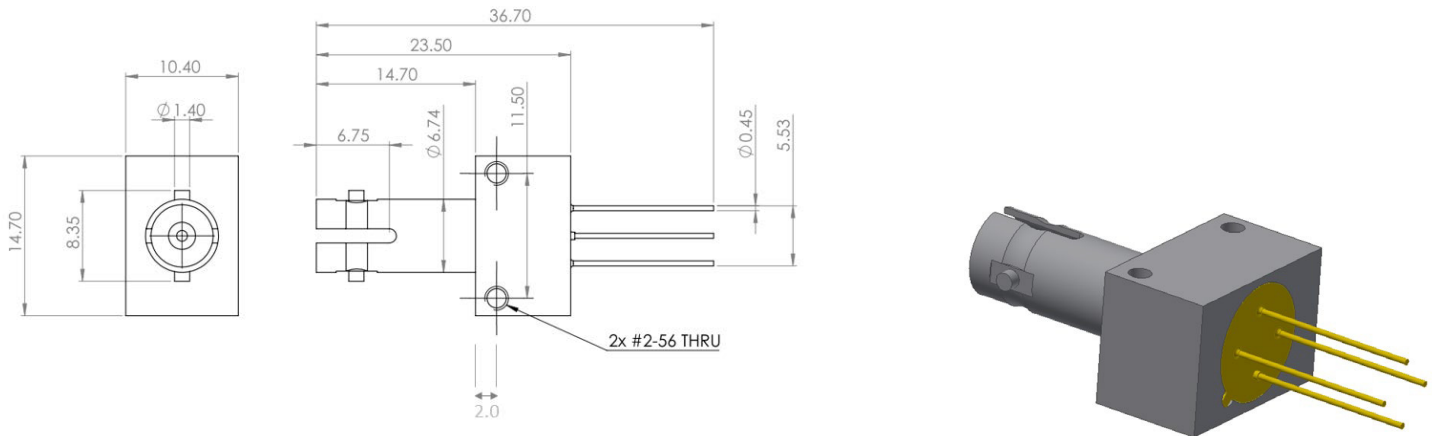

Dimensions are in mm.

Regulatory Compliance

Feature	Test Method	Performance
Electrostatic Discharge (ESD) to the Electrical Pins Human-Body Model	ESDA/JEDEC – JS-001-2012	Min. ± 750V

CAUTION! The p-n junctions in the design of these components are susceptible to damage from electrostatic discharge (ESD). It is advised that precautions be taken in handling these components to prevent damage and/or degradation that may be induced by ESD.

Assembly Process and Compatibility

Parameter	Symbol	Min.	Typ.	Max.	Unit
Solder Environment	T_{SOLD}	—	—	260 ^a	°C
	t_{SOLD}	—	—	10 ^b	seconds

a. Maximum temperature refers to peak temperature.

b. Maximum time refers to time spent at peak temperature.

The device can be secured with 2-56 screws for easy integration with the power board and the chosen heat-sink design. Sufficient heat-sink performance is required to avoid high operating temperatures and to maintain good performance. It is also recommended to select a good-performance thermal interface material (TIM) to mount the device on the heat sink. For example, at 6W of input power with an external load utilizing one-half of the input power, a heat-sink performance of better than 10°C/W is required to maintain a chip temperature of 30°C above ambient.

Pin Description

Figure 2: Backside View

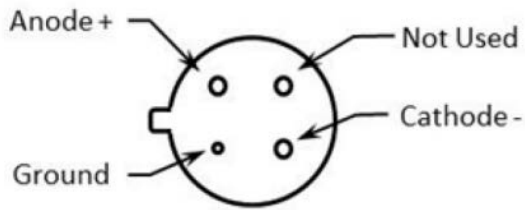

AFBR-POC3xxAx (ST Port, 4 Pins)

Details about AFBR-POC306A1

- *The AFBR-POC306A1 is a photovoltaic device.*
The device is a multijunction compound semiconductor, which works as a power source without applying external bias while providing electrical power to a load when illuminated. Unlike a standard photovoltaic device, such as a solar cell, which is a large semiconductor p-n junction, the power converter is small. Typically, the device is illuminated by light emanating from an optical fiber; therefore the light is highly concentrated. The AFBR-POC306A1 is uniquely designed to handle these concentrated light levels, which helps to maintain high output of both voltage and current.
- *Do not apply external voltage to the device.*
- *The Anode “+” and Cathode “-” indicate the current flow from “+” to “-”, when a load is connected to the pins and light is coupled into the device.*
- *The AFBR-POC306A1 operates without applying additional external voltage.*
- *Use of voltage regulators is recommended for a stable, efficient, and controlled power extraction from the AFBR-POC306A1.*

Typically, photovoltaic devices, such as solar cells, do not have a continuous operating point. To reach the highest conversion performance, the load must be adapted accordingly. This adjustment is primarily due to the influence of the optical input power to the device output. Therefore, a fixed-load power extraction is not an optimum method for power harvesting with solar cells.

Conversely, the Broadcom optical power converters operate with controllable laser light coupled into optical fiber, which results in stabilized output of the AFBR-POC306A1 device. For most applications, combining the device with a voltage regulator, such as a DC/DC converter, is sufficient. Integration of ICs that provide automatic maximum power point tracking (MPPT) can be done, but is typically not needed.

Figure 3: Illustration of an I-V Curve of Optical Power Converters

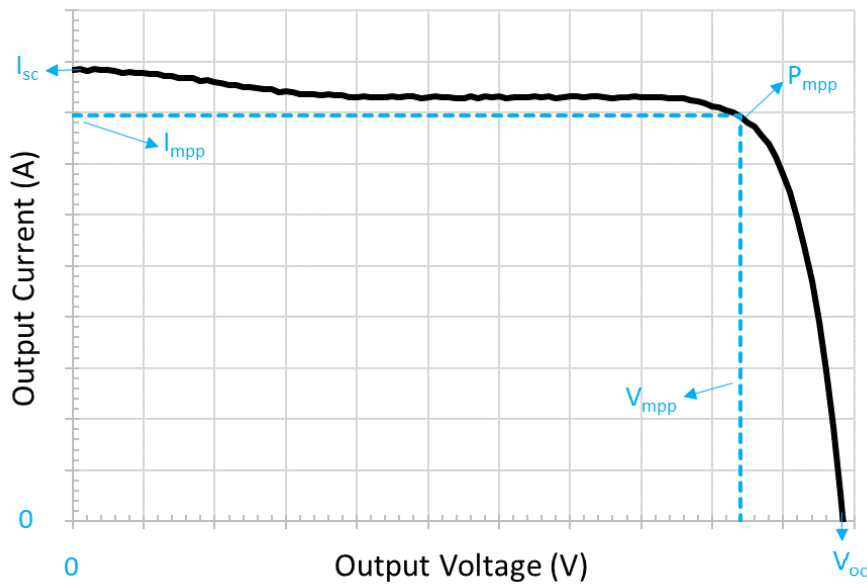

The output current vs. output voltage characteristics of a typical optical power converter is illustrated in Figure 3. At short circuit, the current output (I_{sc}) is at its maximum, but no power is delivered. At open circuit (V_{oc}), the voltage is at its maximum, but no power can be extracted. In between, there is a maximum power point (P_{mpp}) at which the product of the current (I_{mpp}) and the voltage (V_{mpp}) reaches a maximum. Ideally, the external load should be tailored to allow the device to operate near V_{mpp} and I_{mpp} , that is, for a load $R_{mpp} \sim V_{mpp}/I_{mpp}$. Note that R_{mpp} varies with the input power (P_{in}).

Absolute Maximum Ratings

Absolute maximum ratings are those values beyond which damage to the device may occur if these limits are exceeded for other than a short period of time.

Parameter	Symbol	Min.	Typ.	Max.	Units
Storage Temperature	T_S	-40	25	85	°C
Operating Case Temperature	T_C	-40	—	90	°C
Relative Humidity	RH	5	—	95	%
Maximum Optical Input Power ^a AFBR-POC306A1	$P_{opt IN}$	—	—	6	W

a. Proper heat sinking is required. Insufficient heat sinking affects the maximum electrical output power level if the operating case temperature is exceeded as a result of inadequate heat sinking to extract excess heat.

Fiber Specifications

The input fiber should be protected by a sleeve or ceramic ferrule during handling.

Parameter	Symbol	Min.	Typ.	Max.	Units
Core Diameter ^a	D	—	Typically insignificant impact between 50 μm and 400 μm	—	μm
Numeric Aperture ^b	NA	0.20	0.22	0.28	—
Fiber Length ^c	—	—	Application specific	—	meter

- The device typically performs well with most types of fiber; that is, there is a lot of flexibility on the choice of the input fiber minimum and maximum fiber core diameter that can be used with AFBR-POC306A1. The device performance is specifically linked to the fiber's numeric aperture value rather than the core diameter choice. Typically, fibers with a core diameter from 50 μm to 400 μm match the specified NA range (0.22 to 0.28).
- NA values smaller than 0.22 can result in lower than optimal output power for the higher input power conditions near the specified maximum optical input power. Conversely, if the NA is too large, part of the beam may hit outside the chip aperture inside the device, and the performance may decrease due to lower currents (wasted input optical power ending up outside the clear aperture). It is worth noting that the actual laser diode NA might be different than its nominal NA if the laser fiber pigtail is relatively short (that is, a laser diode with a nominal fiber NA of 0.22 is sometimes observed to actually have an NA closer to 0.1x for 1m or 2m pigtails).
- Fiber length depends on application requirements, mainly depending on the specific fiber attenuation. For example, a typical GI-MM 62.5- μm /125- μm fiber has an attenuation of around 3 dB/km at 830 nm.

Operating Characteristics

All specified parameters are valid for operations at a 25°C case temperature.^a

Parameter	Symbol	Min.	Typ. ^b	Max.	Units
Response optical input spectrum range ^c	λ_{IN}	800	808 ^d	850	nm
Maximum electrical output power vs. optical input power ^e	P_{out} at 3.0W _{opt IN}	—	1.8	—	W
Output voltage at maximum electrical output power	V_{out} at 3.0W _{opt IN}	—	6.4	—	V
Output current at maximum electrical output power	I_{out} at 3.0W _{opt IN}	—	0.28	—	A
Maximum electrical output power vs. optical input power ^c	P_{out} at 6.0W _{opt IN}	—	3.6	—	W
Output voltage at maximum electrical output power	V_{OUT} at 6.0W _{opt IN}	—	6.35	—	V
Output current at maximum electrical output power	I_{OUT} at 6.0W _{opt IN}	—	0.57	—	A

- Insufficient heat sinking can result in lower device performance due to increased case and device temperatures. Quick testing at the start of illumination or in pulse mode is typically a good method to confirm that the heat sinking is adequate.
- Typical values are average values *measured at a 25°C case temperature*.
- The product can be safely used outside the recommended range, but the performance will be lower.
- The AFBR-POC306A1 is normally optimized around a spectral input of 808 nm by default; for large enough orders, a custom peak response can be accommodated.
- Verified with light emitted by laser at 808 nm coupled into an MM fiber with an NA of 0.22. Power measured with a large area detector at the end of the MM fiber.

Figure 4: Typical Current/Voltage Behavior for 1.5W, 3W, & 6W Optical Input at 808 nm at a Case Temperature of 25°C. Data from Multiple Devices of a Representative Production Lot.

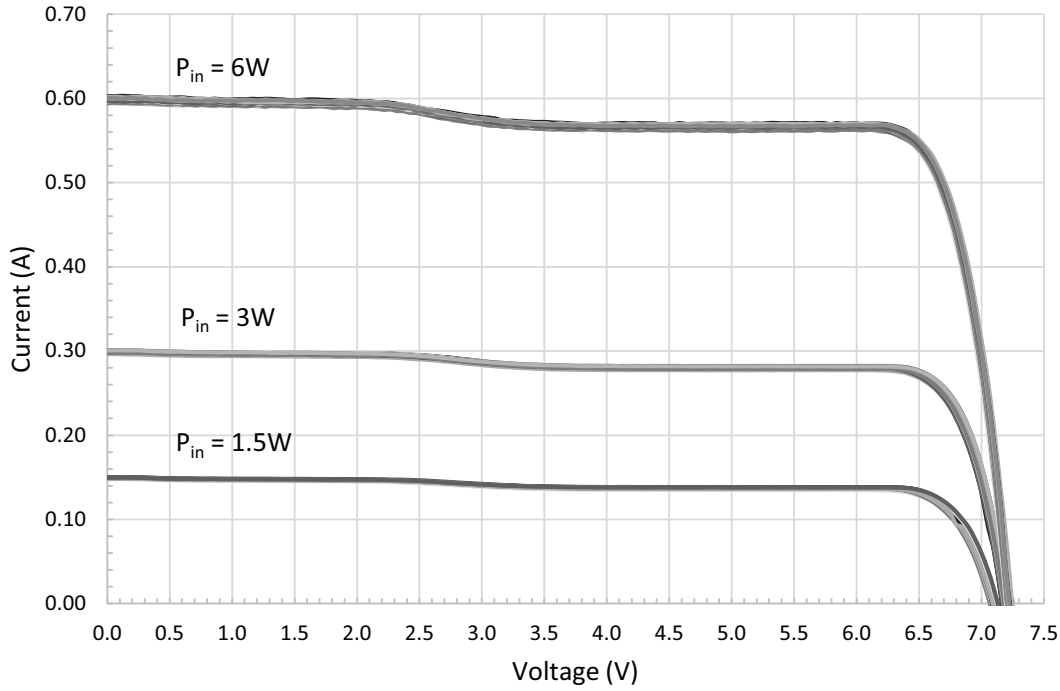

Figure 5: Typical Input Power Dependence of the Maximum Power Point Output Power (P_{mpp} or optimal P_{out}) at a Case Temperature of 25°C for P_{in} at 808 nm.

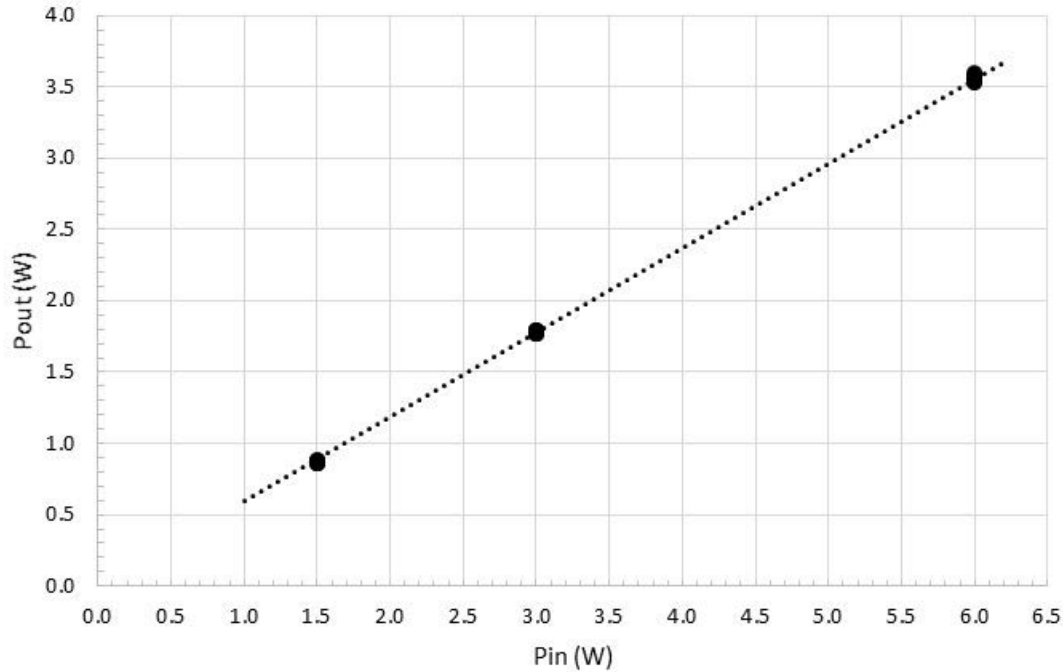

Figure 6: Typical Output Voltage (V_{oc} & V_{mpp}) at a Case Temperature of 25°C for AFBR-POC306A1 vs. Input Power at 808 nm

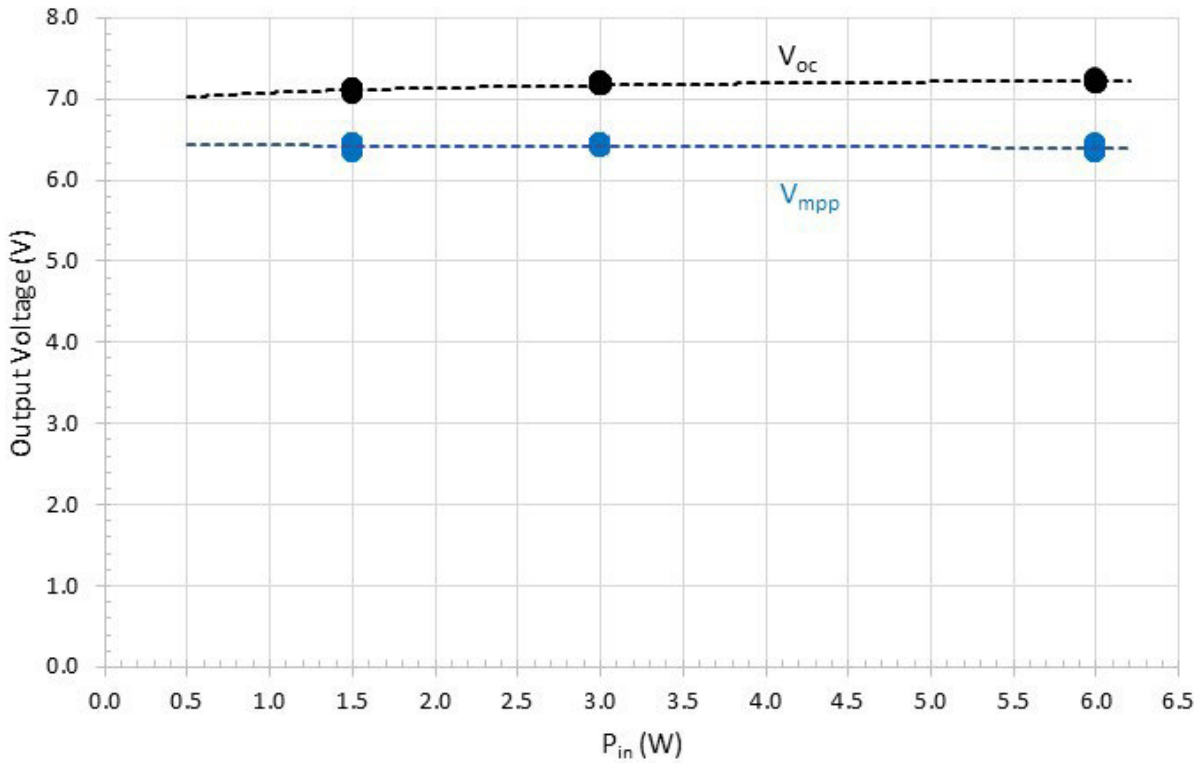

Figure 7: Typical Output current (I_{sc} & I_{mpp}) at a case temperature of 25°C for AFBR-POC306A1 vs. input power at 808 nm

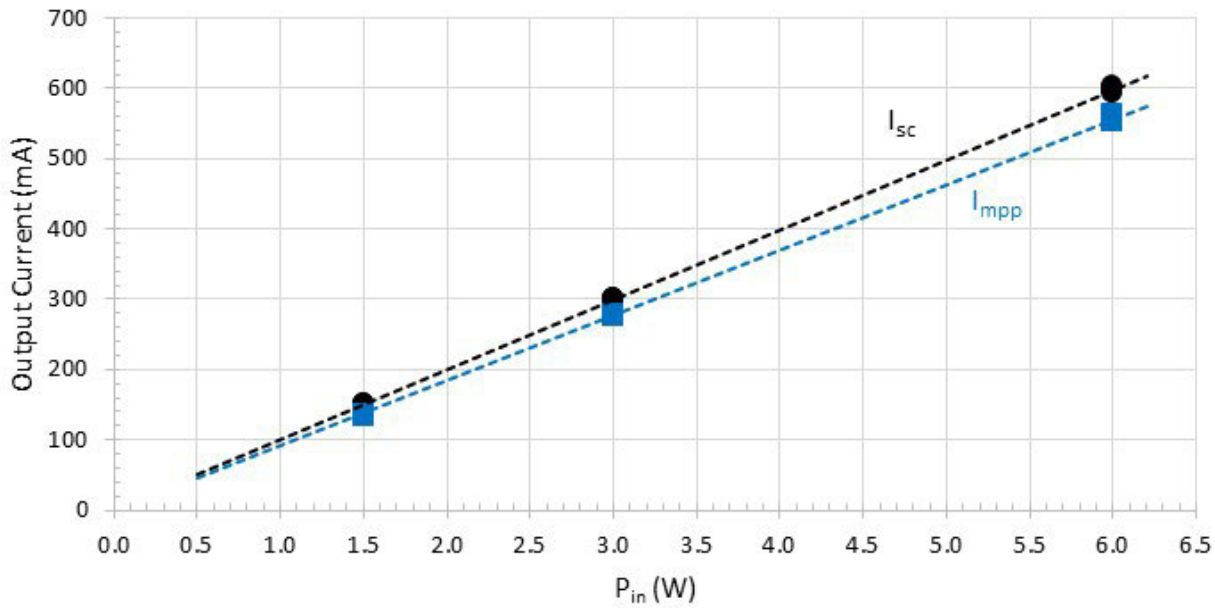

Figure 8: Typical Output Power (P_{mpp}) vs. Case Temperature for the AFBR-POC306A1 at 808 nm

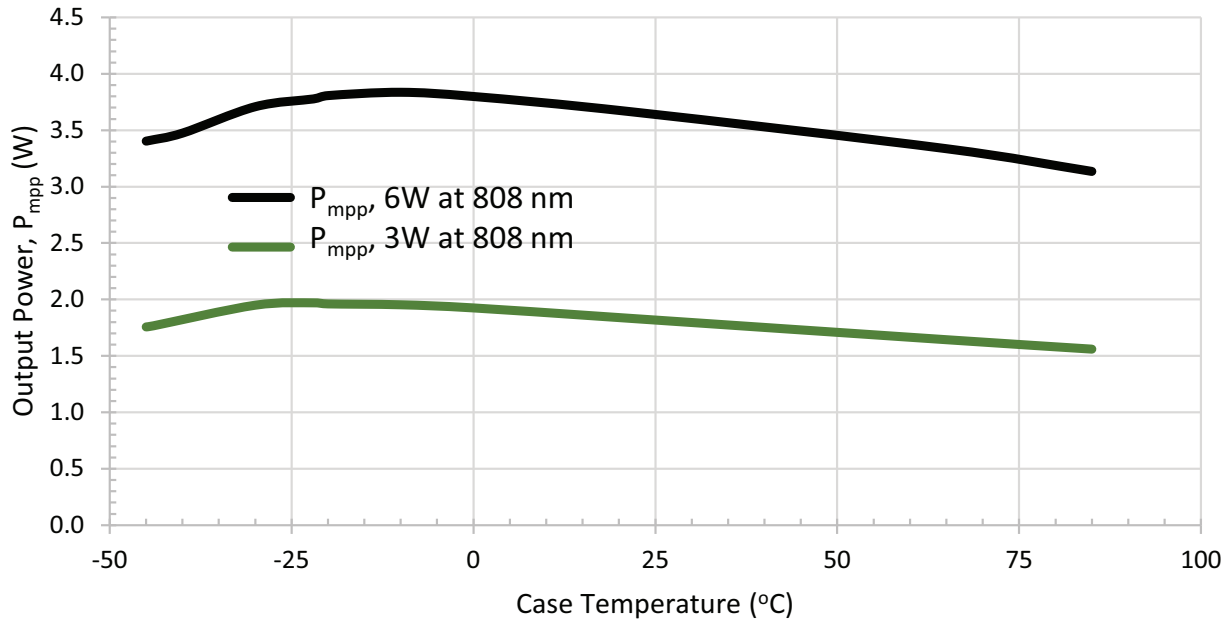

Figure 9: Typical Output Voltage (V_{oc} & V_{mpp}) vs. Case Temperature for the AFBR-POC306A1 at 808 nm

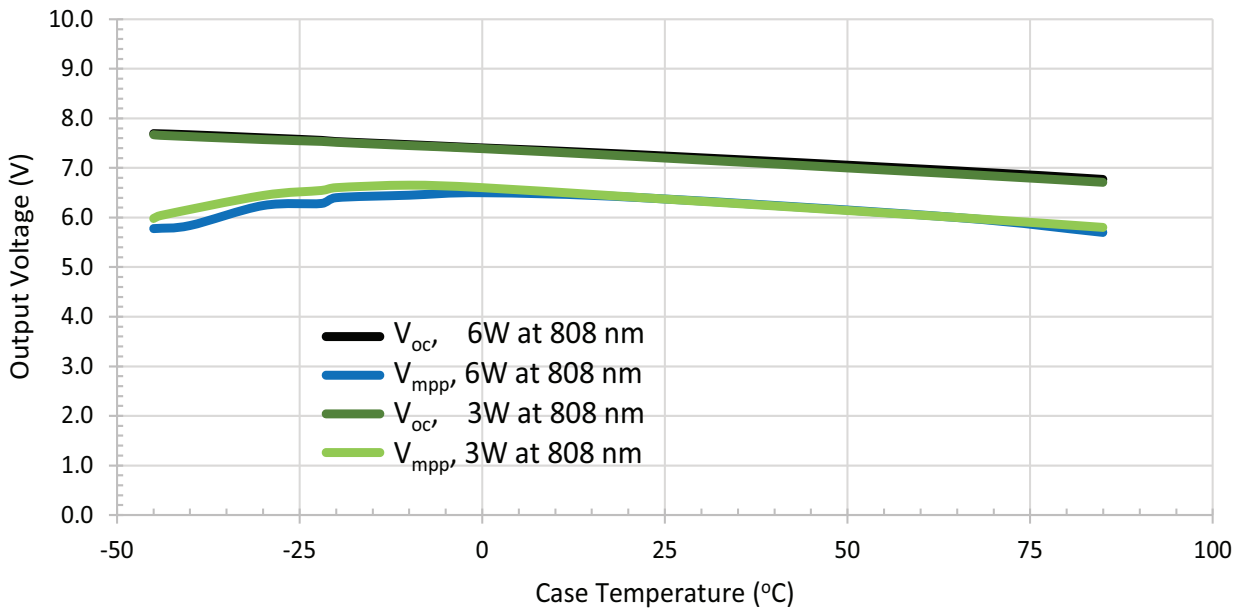
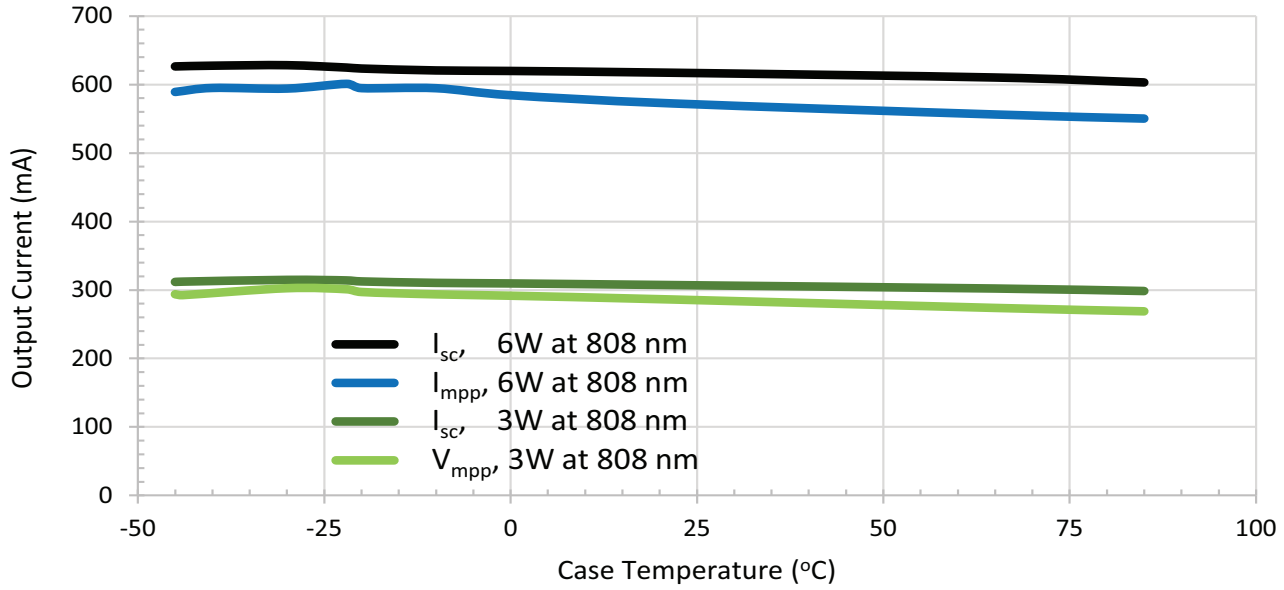

Figure 10: Typical Output Current (I_{sc} & I_{mpp}) vs. Case Temperature for the AFBR-POC306A1 at 808 nm



Copyright © 2022 Broadcom. All Rights Reserved. The term “Broadcom” refers to Broadcom Inc. and/or its subsidiaries. For more information, go to www.broadcom.com. All trademarks, trade names, service marks, and logos referenced herein belong to their respective companies.

Broadcom reserves the right to make changes without further notice to any products or data herein to improve reliability, function, or design. Information furnished by Broadcom is believed to be accurate and reliable. However, Broadcom does not assume any liability arising out of the application or use of this information, nor the application or use of any product or circuit described herein, neither does it convey any license under its patent rights nor the rights of others.