



LM358

LINEAR INTEGRATED CIRCUIT

DUAL OPERATIONAL AMPLIFIER

DESCRIPTION

The UTC **LM358** consists of two independent high gain, internally frequency compensated operational amplifier. It can be operated from a single power supply and also split power supplies.

FEATURES

- *Internally frequency compensated for unity gain.
- *Wide power supply range 3V - 32V.
- *Input common-mode voltage range include ground.
- *Large DC voltage gain.

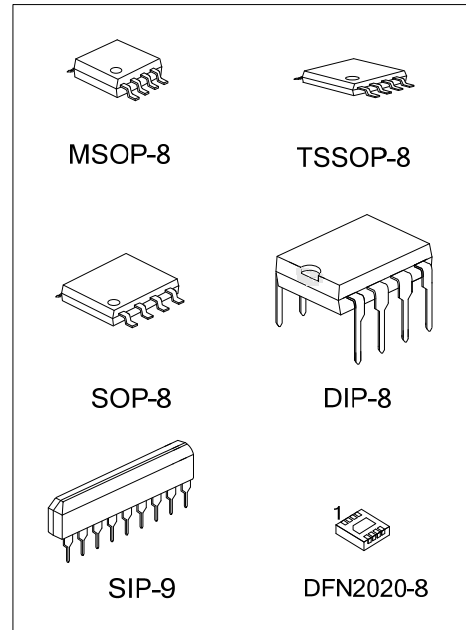

ORDERING INFORMATION

Ordering Number		Package	Packing
Lead Free	Halogen-Free		
LM358L-D08-T	LM358G-D08-T	DIP-8	Tube
LM358L-L09-T	LM358G-G09-T	SIP-9	Tube
LM358L-P08-R	LM358G-P08-R	TSSOP-8	Tape Reel
LM358L-S08-R	LM358G-S08-R	SOP-8	Tape Reel
LM358L-SM1-R	LM358G-SM1-R	MSOP-8	Tape Reel
LM358L-K08-2020-R	LM358G-K08-2020-R	DFN2020-8	Tape Reel

<p>LM358G-D08-T</p>	<p>(1) Packing Type</p> <p>(2) Package Type</p> <p>(3) Green Package</p>	<p>(1) T: Tube, R: Tape Reel</p> <p>(2) D08: DIP-8, G09: SIP-9, S08: SOP-8, P08: TSSOP-8, SM1: MSOP-8, K08-2020: DFN2020-8</p> <p>(3) G: Halogen Free and Lead Free, L: Lead Free</p>
---------------------	--	---

MARKING

DIP-8	SOP-8/MSOP-8	TSSOP-8
<p>UTC □□□□ → Date Code</p> <p>LM358 □ □ → L: Lead Free, G: Halogen Free</p> <p>□ □ → Lot Code</p>	<p>UTC □□□□ → Date Code</p> <p>LM358 □ □ → L: Lead Free, G: Halogen Free</p> <p>□ □ → Lot Code</p>	<p>UTC □□□□ → Date Code</p> <p>LM358 □ □ → L: Lead Free, G: Halogen Free</p> <p>□ □ → Lot Code</p>
SIP-9	DFN2020-8	
<p>UTC □□□□ → Date Code</p> <p>LM358 □ □ → L: Lead Free, G: Halogen Free</p> <p>□ □ → Lot Code</p>	<p>M58C □□□□ → Date Code</p>	

■ PIN DESCRIPTION

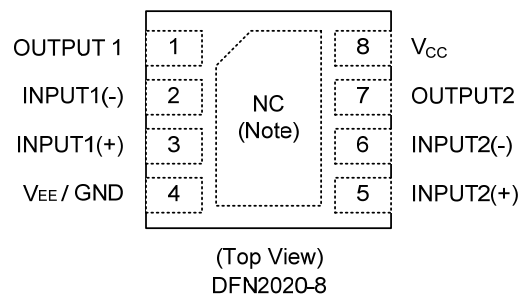
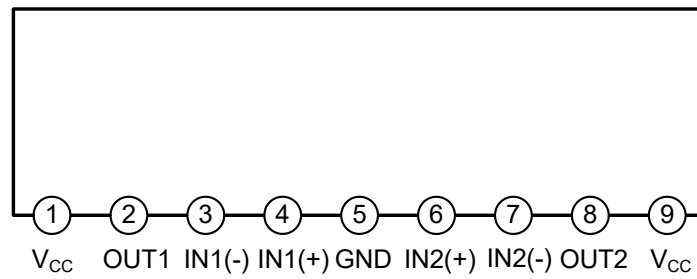
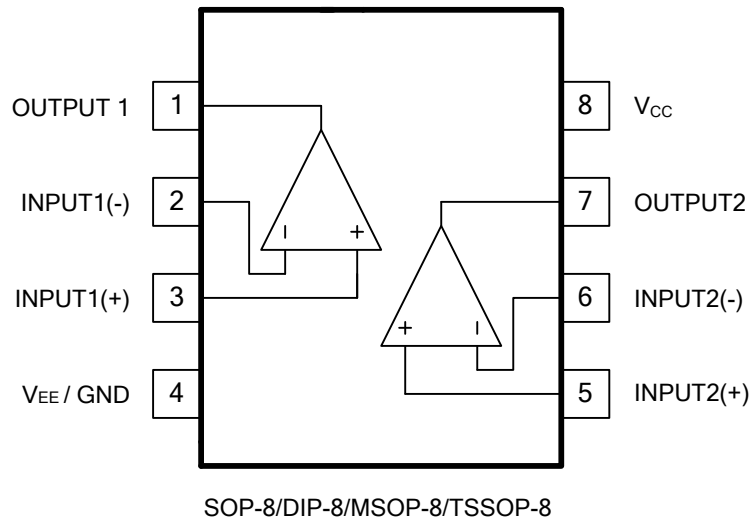

Note: No connect.

■ BLOCK DIAGRAM

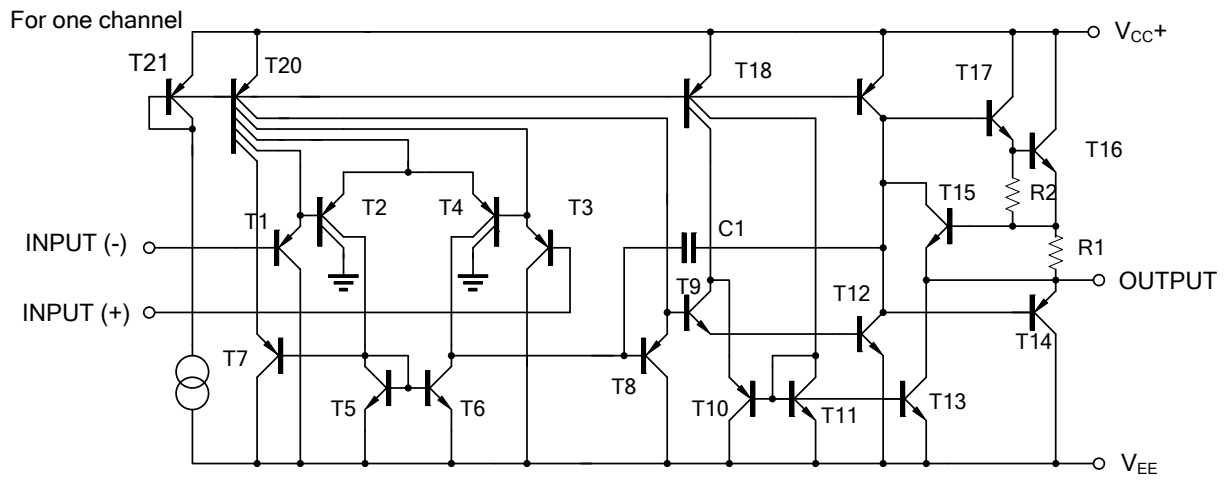

■ ABSOLUTE MAXIMUM RATINGS

PARAMETER		SYMBOL	RATINGS	UNIT
Supply Voltage		V_{CC}	± 16 or 32	V
Differential Input Voltage		$V_{I(DIFF)}$	± 32	V
Input Voltage		V_I	-0.3 ~ +32	V
Output Short to Ground			Continuous	
Power Dissipation	SIP-9	P_D	750	mW
	DIP-8		625	mW
	SOP-8		440	mW
	TSSOP-8		360	mW
	MSOP-8		300	mW
	DFN2020-8		830	mW
Junction Temperature		T_J	+150	$^{\circ}C$
Operating Temperature (Note 2)		T_{OPR}	-20 ~ +85	$^{\circ}C$
Storage Temperature		T_{STG}	-65 ~ +150	$^{\circ}C$

Notes: 1. Absolute maximum ratings are those values beyond which the device could be permanently damaged.

Absolute maximum ratings are stress ratings only and functional device operation is not implied.

2. It is guarantee by design, not 100% be tested.

■ ELECTRICAL CHARACTERISTICS ($V_{CC}=5.0V$, $V_{EE}=GND$, $T_A=25^{\circ}C$, unless otherwise specified)

PARAMETER	SYMBOL	TEST CONDITIONS	MIN	TYP	MAX	UNIT
Input Offset Voltage	$V_{I(OFF)}$	$V_{CM}=0V$ to $V_{CC}-1.5V$ $V_{O(P)}=1.4V$, $R_S=0\Omega$		2.0	5.0	mV
Input Common Mode Voltage	$V_{I(CM)}$	$V_{CC}=3V\sim 30V$	0		$V_{CC}-1.5$	V
Differential Input Voltage	$V_{I(DIFF)}$				V_{CC}	V
Input Offset Current	$I_{I(OFF)}$			5	50	nA
Input Bias Current	$I_{I(BIAS)}$			45	250	nA
Output Voltage Swing	V_{OH}	$V_{CC}=5V$, $R_L=2K\Omega$	$V_{CC}-1.6$			V
		$V_{CC}=30V$, $R_L=2K\Omega$	26			V
		$V_{CC}=30V$, $R_L=10K\Omega$	27	28		V
	V_{OL}	$V_{CC}=5V$, $R_L \geq 10K\Omega$		5	20	mV
Large Signal Voltage Gain	G_V	$V_{CC}=15V$, $R_L \geq 2K\Omega$ $V_{O(P)}=1V \sim 11V$	25	100		V/mV
Power Supply Current	I_{CC}	$R_L=\infty$, $V_{CC}=30V$		0.8	2.0	mA
		$R_L=\infty$, $V_{CC}=5V$ Full Temperature Range		0.5	1.2	mA
Short Circuit Current to Ground	I_{SC}			40	70	mA
Output Current	I_{SOURCE}	$V_I(+)=1V$, $V_I(-)=0V$ $V_{CC}=15V$, $V_{O(P)}=2V$	10	30		mA
		$V_I(+)=0V$, $V_I(-)=1V$ $V_{CC}=15V$, $V_{O(P)}=2V$	10	15		mA
	I_{SINK}	$V_I(+)=0V$, $V_I(-)=1V$ $V_{CC}=15V$, $V_{O(P)}=200mV$	12	100		μA
Common Mode Rejection Ratio	CMRR		65	80		dB
Power Supply Rejection Ratio	PSRR		65	100		dB
Channel Separation	CS	$f=1KHZ \sim 20KHZ$		120		dB
Gain Bandwidth Product	GBW			1		MHz
Slew Rate	SR			0.5		V/ μs

TYPICAL CHARACTERISTICS

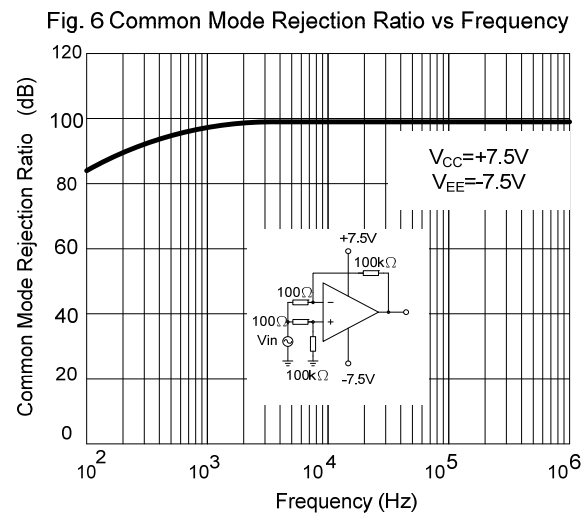
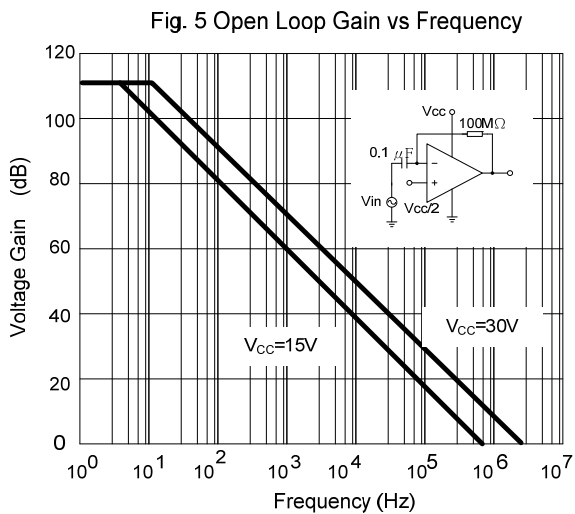
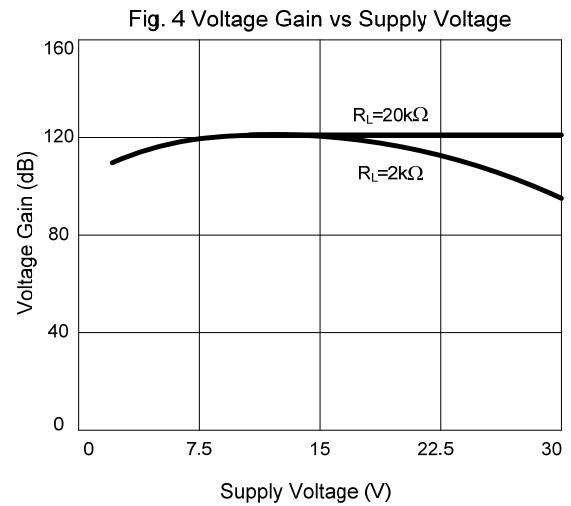
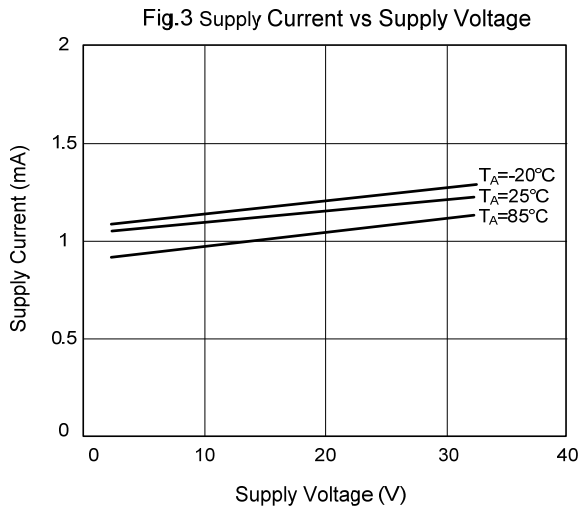
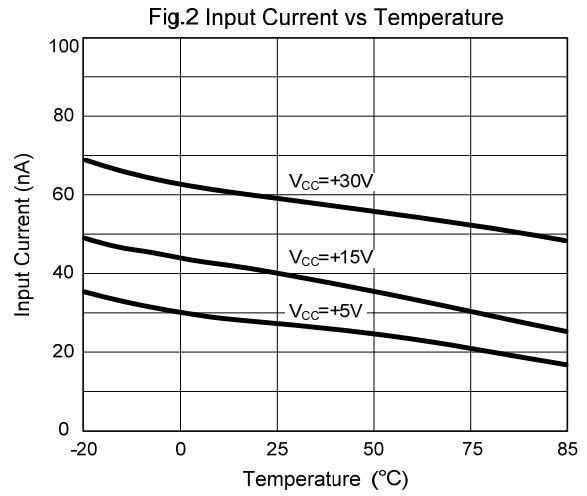
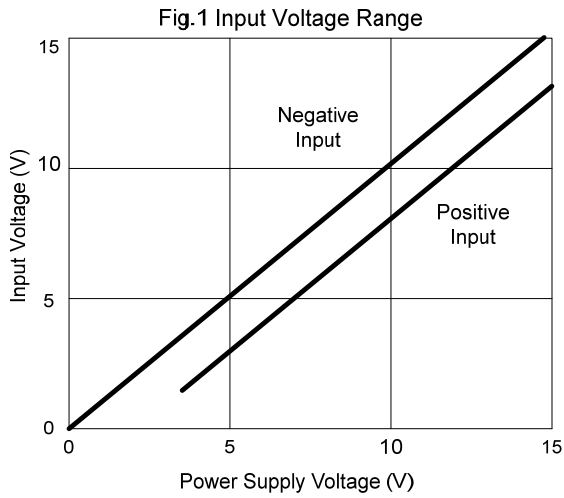

TYPICAL CHARACTERISTICS (Cont.)

Fig. 7 Voltage Follower Pulse Response

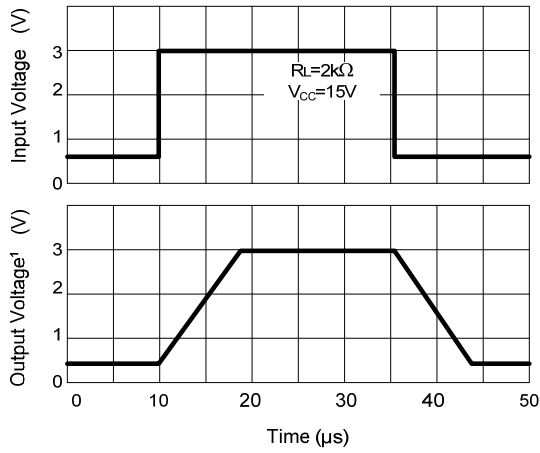

Fig. 8 Voltage Follower Response (Small Signal)

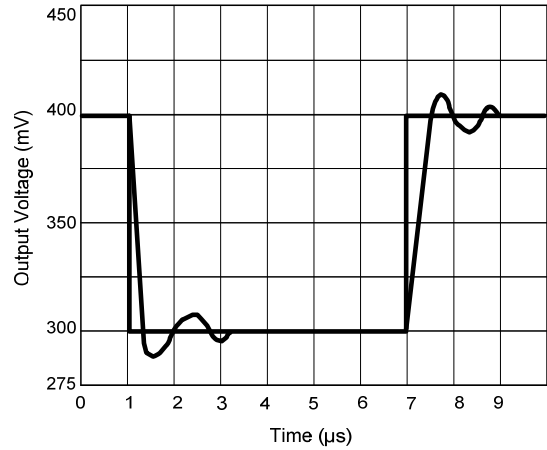

Fig. 9 Gain vs. Large Signal Frequency

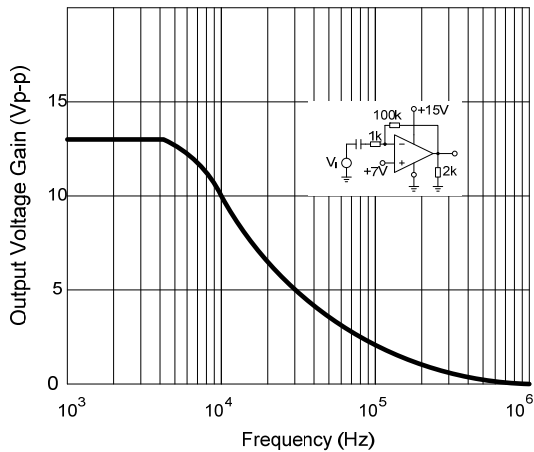

Fig. 10 Output Source Current vs Output Voltage

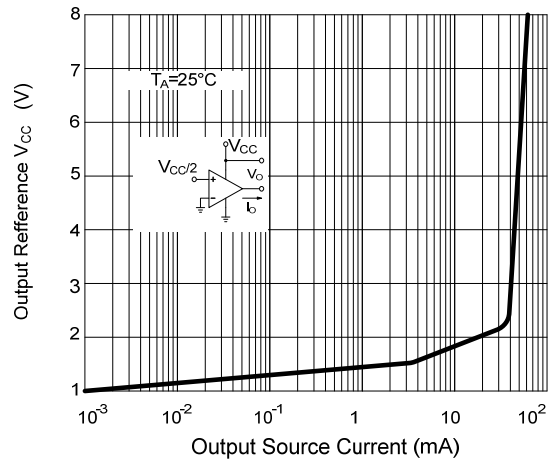

Fig. 11 Output Sink Current vs Output Voltage

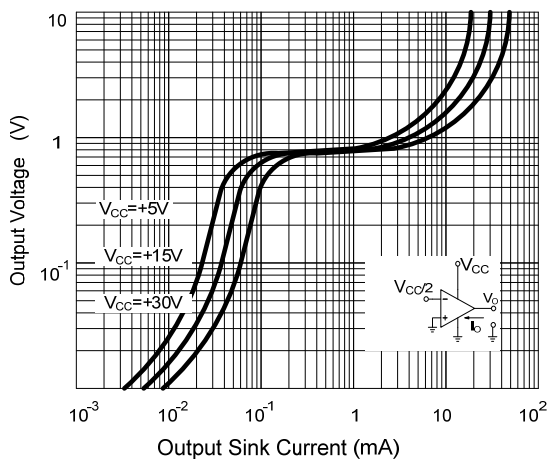
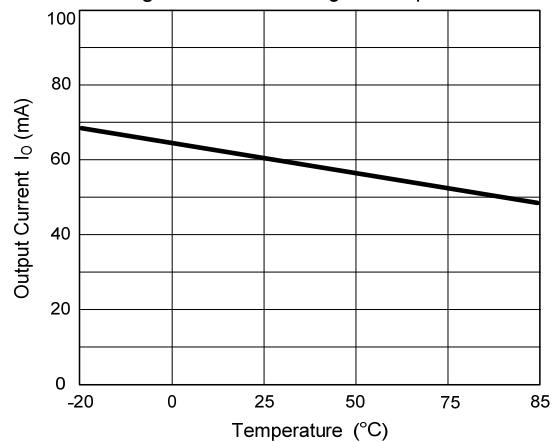

Fig. 12 Current Limiting vs Temperature



UTC assumes no responsibility for equipment failures that result from using products at values that exceed, even momentarily, rated values (such as maximum ratings, operating condition ranges, or other parameters) listed in products specifications of any and all UTC products described or contained herein. UTC products are not designed for use in life support appliances, devices or systems where malfunction of these products can be reasonably expected to result in personal injury. Reproduction in whole or in part is prohibited without the prior written consent of the copyright owner. UTC reserves the right to make changes to information published in this document, including without limitation specifications and product descriptions, at any time and without notice. This document supersedes and replaces all information supplied prior to the publication hereof.