

# 14V<sub>IN</sub>, 4A Step-Down DC/DC $\mu$ Module Regulator

## FEATURES

- Complete Solution in <math>1\text{cm}^2</math> (Single-Sided PCB) or <math>0.5\text{cm}^2</math> (Dual-Sided PCB) 
- Wide Input Voltage Range: 4V to 14V
- Input Voltage Down to 2.375V with External Bias
- 0.6V to 5.5V Output Voltage
- 4A DC, 5A Peak Output Current
- $\pm 2\%$  Total DC Output Voltage Error
- Current Mode Control, Fast Transient Response
- Output Voltage Tracking
- Selectable Discontinuous Mode
- Power Good Indicator
- Overvoltage, Overcurrent and Overtemperature Protection
- 6.25mm  $\times$  6.25mm  $\times$  5.01mm BGA Package

## APPLICATIONS

- Telecom, Datacom, Networking and Industrial Equipment
- Medical Diagnostic Equipment
- Data Storage Rack Units and Cards
- Test and Debug Systems

## DESCRIPTION

The LTM<sup>®</sup>4624 is a complete 4A step-down switching mode  $\mu$ Module<sup>®</sup> (micromodule) regulator in a tiny 6.25mm  $\times$  6.25mm  $\times$  5.01mm BGA package. Included in the package are the switching controller, power FETs, inductor and support components. Operating over an input voltage range of 4V to 14V or 2.375V to 14V with an external bias supply, the LTM4624 supports an output voltage range of 0.6V to 5.5V, set by a single external resistor. Its high efficiency design delivers 4A continuous, 5A peak, output current. Only bulk input and output capacitors are needed.

The LTM4624 supports selectable discontinuous mode operation and output voltage tracking for supply rail sequencing. Its high switching frequency and current mode control enable a very fast transient response to line and load changes without sacrificing stability.

Fault protection features include overvoltage, overcurrent and overtemperature protection.

The LTM4624 is available with SnPb (BGA) or RoHS compliant terminal finish.

All registered trademarks and trademarks are the property of their respective owners.

 [Click to view associated TechClip Videos.](#)

## TYPICAL APPLICATION

4A, 1.5V Output DC/DC  $\mu$ Module Step-Down Regulator

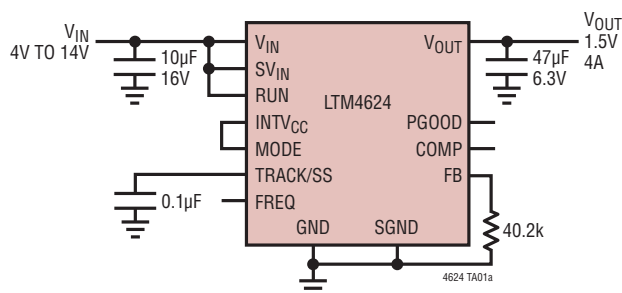

12V<sub>IN</sub> Efficiency vs Load Current

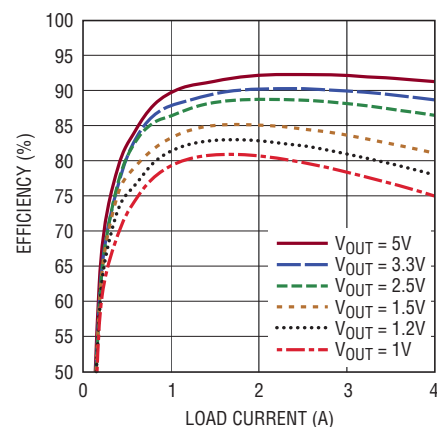

4624 TA01b

## ABSOLUTE MAXIMUM RATINGS

(Note 1)

|   |                          |
|---|--------------------------|
| $V_{IN}$ , $SV_{IN}$ .....  | -0.3V to 15V             |
| $V_{OUT}$ (Note 4) .....  | -0.3V to $SV_{IN}$ or 6V |
| RUN .....   | -0.3V to 15V             |
| $INTV_{CC}$ .....   | -0.3V to 3.6V            |
| PGOOD, MODE, TRACK/SS, FREQ .....                                   | -0.3V to $INTV_{CC}$     |
| COMP, FB (Note 4) .....   | -0.3V to $INTV_{CC}$     |
| Internal Operating Junction Temperature Range<br>(Notes 2, 5) ..... | -40°C to 125°C           |
| Storage Temperature Range .....                                     | -55°C to 125°C           |
| Peak Solder Reflow Body Temperature .....                           | 245°C                    |

## PIN CONFIGURATION

(See Pin Functions and Table 7)

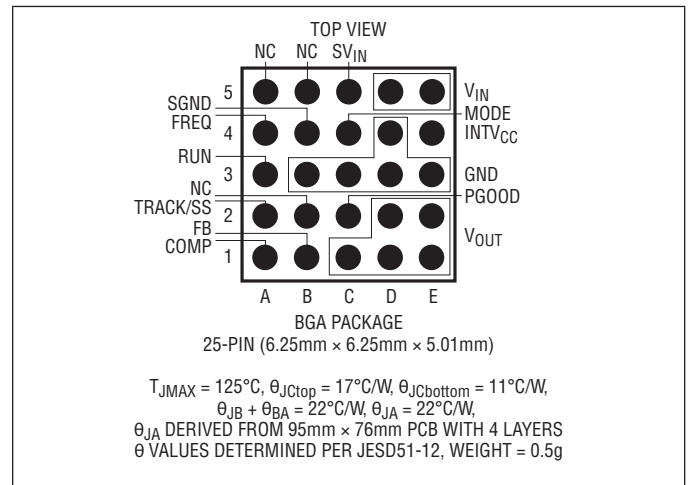

## ORDER INFORMATION

| PART NUMBER   | PAD OR BALL FINISH | PART MARKING* |             | PACKAGE TYPE | MSL RATING | TEMPERATURE RANGE (See Note 2) |
|---------------|--------------------|---------------|-------------|--------------|------------|--------------------------------|
|               |                    | DEVICE        | FINISH CODE |              |            |                                |
| LTM4624EY#PBF | SAC305 (RoHS)      | LTM4624Y      | e1          | BGA          | 3          | -40°C to 125°C                 |
| LTM4624IY#PBF | SAC305 (RoHS)      | LTM4624Y      | e1          | BGA          | 3          | -40°C to 125°C                 |
| LTM4624IY     | SnPb (63/37)       | LTM4624Y      | e0          | BGA          | 3          | -40°C to 125°C                 |

• Contact the factory for parts specified with wider operating temperature ranges. Device temperature grade is indicated by a label on the shipping container. \*Pad or ball finish code is per IPC/JEDEC J-STD-609.

- [Recommended LGA and BGA PCB Assembly and Manufacturing Procedures](#)
- [LGA and BGA Package and Tray Drawings](#)

For more information on lead free part marking, go to: <http://www.adi.com/leadfree/>  
For more information on tape and reel specifications, go to: <http://www.adi.com/tapeand reel/>

## ELECTRICAL CHARACTERISTICS

The ● denotes the specifications which apply over the full internal operating temperature range (Note 2), otherwise specifications are at  $T_A = 25^\circ\text{C}$ .  $V_{IN} = SV_{IN} = 12\text{V}$  per the typical application shown on the front page.

| SYMBOL  | PARAMETER  | CONDITIONS   | MIN   | TYP           | MAX          | UNITS         |                |
|---|--|--|-------|---------------|--------------|---------------|----------------|
| <b>Switching Regulator Section: per Channel</b> |  |  |       |               |              |               |                |
| $V_{IN}$  | Input DC Voltage                                   | $SV_{IN} = V_{IN}$   | ● 4   |               | 14           | V             |                |
| $V_{OUT(RANGE)}$                                | Output Voltage Range                               |  | ● 0.6 |               | 5.5          | V             |                |
| $V_{OUT(DC)}$                                   | Output Voltage, Total Variation with Line and Load | $C_{IN} = 22\mu\text{F}$ , $C_{OUT} = 100\mu\text{F}$ Ceramic, $R_{FB} = 40.2\text{k}$ ,<br>MODE = $INTV_{CC}$ , $V_{IN} = 4\text{V}$ to 14V, $I_{OUT} = 0\text{A}$ to 4A (Note 3)<br>0°C to 125°C<br>-40°C to 125°C |       | 1.477<br>1.47 | 1.50<br>1.50 | 1.523<br>1.53 | V<br>V         |
| $V_{RUN}$                                       | RUN Pin On Threshold                               | $V_{RUN}$ Rising   |       | 1.1           | 1.2          | 1.3           | V              |
| $I_Q(SV_{IN})$                                  | Input Supply Bias Current                          | $V_{IN} = 12\text{V}$ , $V_{OUT} = 1.5\text{V}$ , MODE = $INTV_{CC}$<br>$V_{IN} = 12\text{V}$ , $V_{OUT} = 1.5\text{V}$ , MODE = GND<br>Shutdown, RUN = 0, $V_{IN} = 12\text{V}$                                     |       | 6<br>2<br>11  |              |               | mA<br>mA<br>μA |
| $I_S(V_{IN})$                                   | Input Supply Current                               | $V_{IN} = 12\text{V}$ , $V_{OUT} = 1.5\text{V}$ , $I_{OUT} = 4\text{A}$  |       | 0.62          |              |               | A              |
| $I_{OUT(DC)}$                                   | Output Continuous Current Range                    | $V_{IN} = 12\text{V}$ , $V_{OUT} = 1.5\text{V}$  |       | 0             |              | 4             | A              |

Rev. E

## ELECTRICAL CHARACTERISTICS

The ● denotes the specifications which apply over the full internal operating temperature range (Note 2), otherwise specifications are at  $T_A = 25^\circ\text{C}$ .  $V_{IN} = SV_{IN} = 12\text{V}$  per the typical application shown on the front page.

| SYMBOL                                | PARAMETER                              | CONDITIONS  | MIN | TYP            | MAX           | UNITS         |            |
|---------------------------------------|--|---|-----|----------------|---------------|---------------|------------|
| $\Delta V_{OUT}(\text{Line})/V_{OUT}$ | Line Regulation Accuracy               | $V_{OUT} = 1.5\text{V}$ , $V_{IN} = 4\text{V}$ to $14\text{V}$ , $I_{OUT} = 0\text{A}$  | ●   | 0.04           | 0.15          | %/V           |            |
| $\Delta V_{OUT}(\text{Load})/V_{OUT}$ | Load Regulation Accuracy               | $V_{OUT} = 1.5\text{V}$ , $I_{OUT} = 0\text{A}$ to $4\text{A}$  | ●   | 1              | 1.5           | %             |            |
| $V_{OUT(AC)}$                         | Output Ripple Voltage                  | $I_{OUT} = 0\text{A}$ , $C_{OUT} = 100\mu\text{F}$ Ceramic, $V_{IN} = 12\text{V}$ , $V_{OUT} = 1.5\text{V}$                                     |     | 5              |               | mV            |            |
| $\Delta V_{OUT(\text{START})}$        | Turn-On Overshoot                      | $I_{OUT} = 0\text{A}$ , $C_{OUT} = 100\mu\text{F}$ Ceramic, $V_{IN} = 12\text{V}$ , $V_{OUT} = 1.5\text{V}$                                     |     | 30             |               | mV            |            |
| $t_{\text{START}}$                    | Turn-On Time                           | $C_{OUT} = 100\mu\text{F}$ Ceramic, No Load, TRACK/SS = $0.01\mu\text{F}$ , $V_{IN} = 12\text{V}$ , $V_{OUT} = 1.5\text{V}$                     |     | 2.5            |               | ms            |            |
| $\Delta V_{OUTLS}$                    | Peak Deviation for Dynamic Load        | Load: 0% to 50% to 0% of Full Load, $C_{OUT} = 47\mu\text{F}$ Ceramic, $V_{IN} = 12\text{V}$ , $V_{OUT} = 1.5\text{V}$                          |     | 160            |               | mV            |            |
| $t_{\text{SETTLE}}$                   | Settling Time for Dynamic Load Step    | Load: 0% to 50% to 0% of Full Load, $C_{OUT} = 47\mu\text{F}$ Ceramic, $V_{IN} = 12\text{V}$ , $V_{OUT} = 1.5\text{V}$                          |     | 40             |               | $\mu\text{s}$ |            |
| $I_{OUTPK}$                           | Output Current Limit                   | $V_{IN} = 12\text{V}$ , $V_{OUT} = 1.5\text{V}$   |     | 5              | 7             | A             |            |
| $V_{FB}$                              | Voltage at FB Pin                      | $I_{OUT} = 0\text{A}$ , $V_{OUT} = 1.5\text{V}$<br>$I_{OUT} = 0\text{A}$ , $V_{OUT} = 1.5\text{V}$ , $-40^\circ\text{C}$ to $125^\circ\text{C}$ | ●   | 0.594<br>0.591 | 0.60<br>0.609 | V<br>V        |            |
| $I_{FB}$                              | Current at FB Pin                      | (Note 4)  |     |                | $\pm 30$      | nA            |            |
| $R_{FBHI}$                            | Resistor Between $V_{OUT}$ and FB Pins |   |     | 60.05          | 60.40         | 60.75         | k $\Omega$ |
| $I_{\text{TRACK/SS}}$                 | Track Pin Soft-Start Pull-Up Current   | TRACK/SS = 0V   |     | 2.5            | 4             | $\mu\text{A}$ |            |
| $V_{IN(UVLO)}$                        | $V_{IN}$ Undervoltage Lockout          | $V_{IN}$ Falling<br>$V_{IN}$ Hysteresis   |     | 2.4            | 2.6<br>350    | 2.8           | V<br>mV    |
| $t_{\text{ON(MIN)}}$                  | Minimum On-Time                        | (Note 4)  |     | 40             |               | ns            |            |
| $t_{\text{OFF(MIN)}}$                 | Minimum Off-Time                       | (Note 4)  |     | 70             |               | ns            |            |
| $V_{\text{PGOOD}}$                    | PGOOD Trip Level                       | $V_{FB}$ With Respect to Set Output<br>$V_{FB}$ Ramping Negative<br>$V_{FB}$ Ramping Positive   |     | -13<br>7       | -10<br>10     | -7<br>13      | %<br>%     |
| $I_{\text{PGOOD}}$                    | PGOOD Leakage                          |   |     |                | 2             | $\mu\text{A}$ |            |
| $V_{\text{PGL}}$                      | PGOOD Voltage Low                      | $I_{\text{PGOOD}} = 1\text{mA}$   |     | 0.02           | 0.1           | V             |            |
| $V_{\text{INTVCC}}$                   | Internal $V_{CC}$ Voltage              | $SV_{IN} = 4\text{V}$ to $14\text{V}$   |     | 3.2            | 3.3           | 3.4           | V          |
| $V_{\text{INTVCC Load Reg}}$          | INTV <sub>CC</sub> Load Regulation     | $I_{CC} = 0\text{mA}$ to $20\text{mA}$  |     | 0.5            |               | %             |            |
| $f_{\text{OSC}}$                      | Oscillator Frequency                   |   |     | 1              |               | MHz           |            |

**Note 1:** Stresses beyond those listed under Absolute Maximum Ratings may cause permanent damage to the device. Exposure to any Absolute Maximum Rating condition for extended periods may affect device reliability and lifetime.

**Note 2:** The LTM4624 is tested under pulsed load conditions such that  $T_J \approx T_A$ . The LTM4624E is guaranteed to meet performance specifications over the  $0^\circ\text{C}$  to  $125^\circ\text{C}$  internal operating temperature range. Specifications over the  $-40^\circ\text{C}$  to  $125^\circ\text{C}$  internal operating temperature range are assured by design, characterization and correlation with statistical process controls. The LTM4624I is guaranteed to meet specifications over the full  $-40^\circ\text{C}$  to  $125^\circ\text{C}$  internal operating temperature range. Note that the maximum ambient temperature consistent with these specifications is determined by specific operating conditions in conjunction with board layout, the rated package thermal resistance and other environmental factors.

**Note 3:** See output current derating curves for different  $V_{IN}$ ,  $V_{OUT}$  and  $T_A$ .

**Note 4:** 100% tested at wafer level.

**Note 5:** This IC includes overtemperature protection that is intended to protect the device during momentary overload conditions. Junction temperature will exceed  $125^\circ\text{C}$  when overtemperature protection is active. Continuous operation above the specified maximum operating junction temperature may impair device reliability.

## TYPICAL PERFORMANCE CHARACTERISTICS

**Efficiency vs Load Current with 5V<sub>IN</sub>**

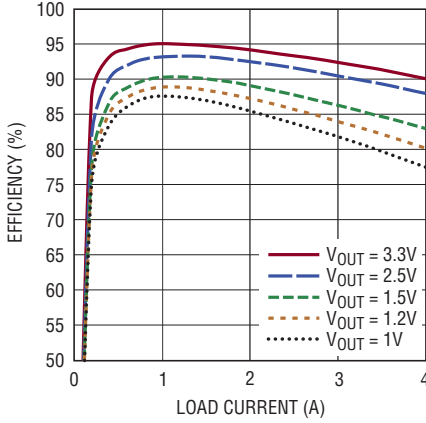

4624 G01

**Efficiency vs Load Current with 12V<sub>IN</sub>**

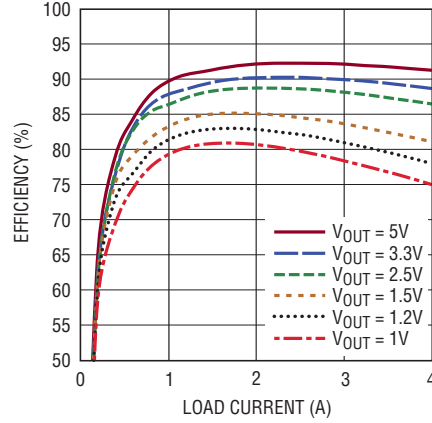

4624 G02

**DCM Mode Efficiency, V<sub>OUT</sub> = 1.5V**

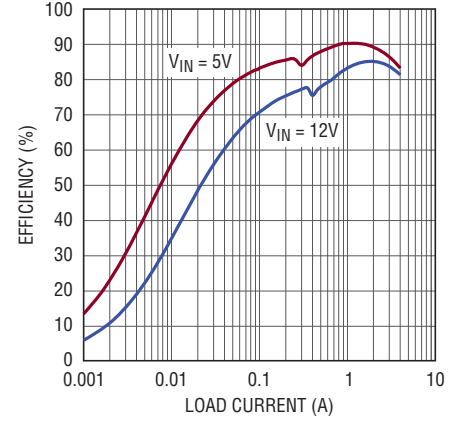

4624 G03

**1V Output Transient Response**

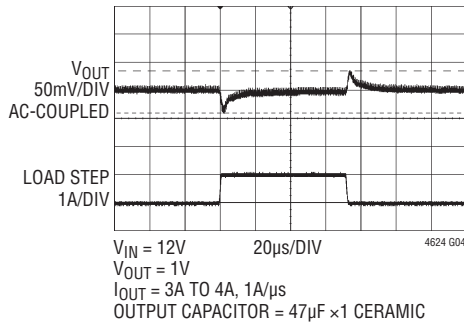

4624 G04

**1.5V Output Transient Response**

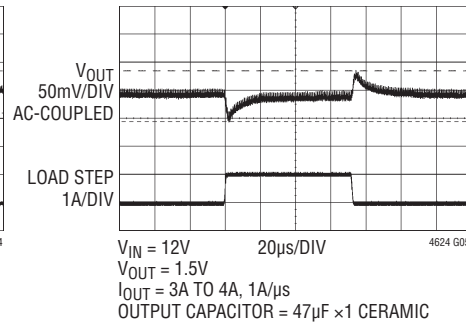

4624 G05

**2.5V Output Transient Response**

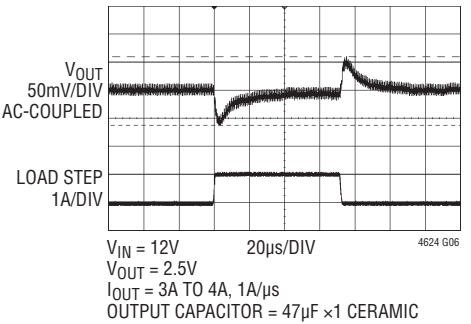

4624 G06

**3.3V Output Transient Response**

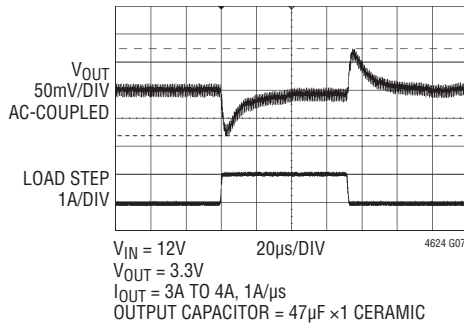

4624 G07

**5V Output Transient Response**

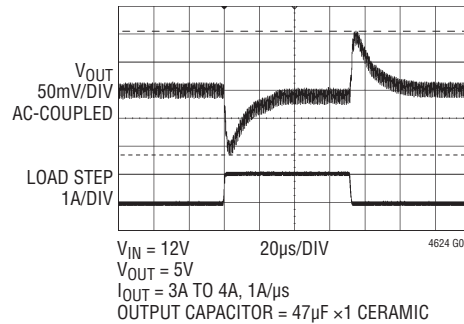

4624 G08

## TYPICAL PERFORMANCE CHARACTERISTICS

### Start-Up with No Load

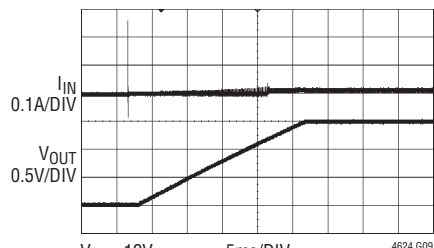

$V_{IN} = 12V$   
 $V_{OUT} = 1.5V$   
 INPUT CAPACITOR = 150 $\mu F$  SANYO ELECTROLYTIC  
 CAPACITOR (OPTIONAL) + 22 $\mu F$  CERAMIC  
 OUTPUT CAPACITOR = 47 $\mu F$  CERAMIC  
 SOFT-START CAPACITOR = 0.1 $\mu F$

### Start-Up with 4A Load

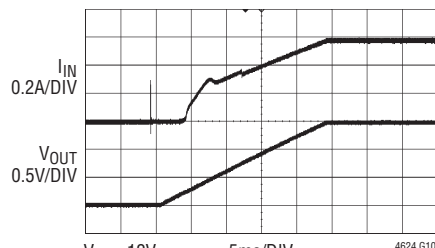

$V_{IN} = 12V$   
 $V_{OUT} = 1.5V$   
 INPUT CAPACITOR = 150 $\mu F$  SANYO ELECTROLYTIC  
 CAPACITOR (OPTIONAL) + 22 $\mu F$  CERAMIC  
 OUTPUT CAPACITOR = 47 $\mu F$  CERAMIC  
 SOFT-START CAPACITOR = 0.1 $\mu F$

### Short-Circuit with No Load

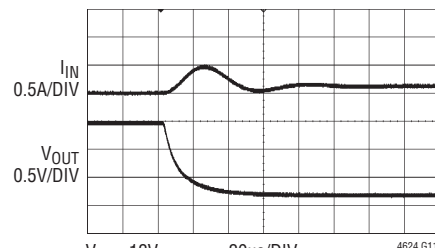

$V_{IN} = 12V$   
 $V_{OUT} = 1.5V$   
 INPUT CAPACITOR = 150 $\mu F$  SANYO ELECTROLYTIC  
 CAPACITOR (OPTIONAL) + 22 $\mu F$  CERAMIC  
 OUTPUT CAPACITOR = 47 $\mu F$  CERAMIC

### Short-Circuit with 4A Load

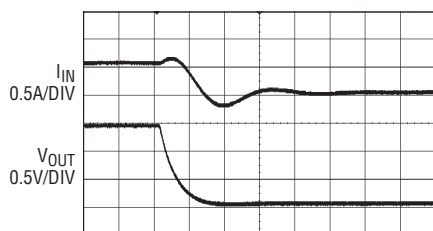

$V_{IN} = 12V$   
 $V_{OUT} = 1.5V$   
 INPUT CAPACITOR = 150 $\mu F$  SANYO ELECTROLYTIC  
 CAPACITOR (OPTIONAL) + 22 $\mu F$  CERAMIC  
 OUTPUT CAPACITOR = 47 $\mu F$  CERAMIC

### Recovery to No Load from Short Circuit

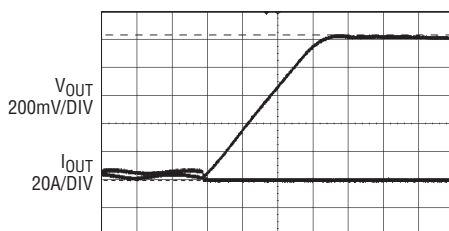

$V_{IN} = 12V$   
 $V_{OUT} = 1V$   
 INPUT CAPACITOR = 22 $\mu F$  SANYO ELECTROLYTIC  
 CAPACITOR (OPTIONAL) + 22 $\mu F$   $\times 2$  CERAMIC  
 OUTPUT CAPACITOR = 47 $\mu F$   $\times 2$  CERAMIC  
 SOFT-START CAPACITOR = 0.1 $\mu F$

### Output Ripple

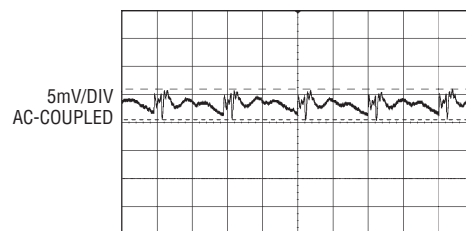

$V_{IN} = 12V$   
 $V_{OUT} = 1.5V$   
 INPUT CAPACITOR = 22 $\mu F$  SANYO ELECTROLYTIC  
 CAPACITOR (OPTIONAL) + 22 $\mu F$   $\times 2$  CERAMIC  
 OUTPUT CAPACITOR = 47 $\mu F$   $\times 2$  CERAMIC  
 SOFT-START CAPACITOR = 0.1 $\mu F$

### Start Into Pre-Bias Output

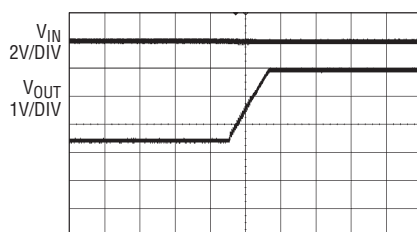

$V_{IN} = 12V$   
 $V_{OUT} = 5V$   
 INPUT CAPACITOR = 22 $\mu F$  SANYO ELECTROLYTIC  
 CAPACITOR (OPTIONAL) + 22 $\mu F$   $\times 2$  CERAMIC  
 OUTPUT CAPACITOR = 47 $\mu F$   $\times 2$  CERAMIC  
 SOFT-START CAPACITOR = 0.1 $\mu F$

### 12V Input to 1.8V Output, 50% Load Transient Response

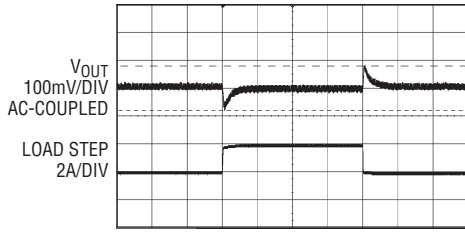

$V_{IN} = 12V$   
 $V_{OUT} = 1.8V$   
 $I_{OUT} = 2A$  TO 4A, 1A/ $\mu s$   
 OUTPUT CAPACITOR = 47 $\mu F$   $\times 1$  CERAMIC

### 5V Input to 1.2V Output, 50% Load Transient Response

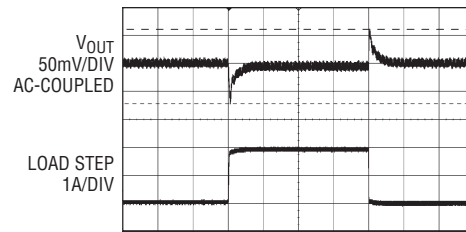

$V_{IN} = 5V$   
 $V_{OUT} = 1.2V$   
 $I_{OUT} = 2A$  TO 4A, 1A/ $\mu s$   
 OUTPUT CAPACITOR = 47 $\mu F$   $\times 1$  CERAMIC

## PIN FUNCTIONS



**PACKAGE ROW AND COLUMN LABELING MAY VARY AMONG  $\mu$ Module PRODUCTS. REVIEW EACH PACKAGE LAYOUT CAREFULLY.**

**COMP (A1):** Current Control Threshold and Error Amplifier Compensation Point. The current comparator's trip threshold is linearly proportional to this voltage, whose normal range is from 0.3V to 1.8V. Tie the COMP pins together for parallel operation. The device is internally compensated.

**TRACK/SS (A2):** Output Tracking and Soft-Start Input. Allows the user to control the rise time of the output voltage. Putting a voltage below 0.6V on this pin bypasses the internal reference input to the error amplifier, and servos the FB pin to match the TRACK/SS voltage. Above 0.6V, the tracking function stops and the internal reference resumes control of the error amplifier. There's an internal 2.5 $\mu$ A pull-up current from INTV<sub>CC</sub> on this pin, so putting a capacitor here provides a soft-start function.

**RUN (A3):** Run Control Input of the Switching Mode Regulator. Enables chip operation by tying RUN above 1.25V. Pulling it below 1.1V shuts down the part. Do not leave floating.

**FREQ (A4):** Frequency is set internally to 1MHz. An external resistor can be placed from this pin to SGND to increase frequency, or from this pin to INTV<sub>CC</sub> to reduce frequency. See the Applications Information section for frequency adjustment.

**NC (A5, B2, B5):** No Connect Pins. Pins are not connected internally. Float or ground these pins.

**FB (B1):** The Negative Input of the Error Amplifier. Internally, this pin is connected to V<sub>OUT</sub> with a 60.4k precision resistor. Different output voltages can be programmed with an additional resistor between the FB and SGND pins. Tying the FB pins together allows for

parallel operation. See the Applications Information section for details.

**GND (B3, C3, D3–D4, E3):** Power Ground Pins for Both Input and Output Returns.

**SGND (B4):** Signal Ground Connection. Tie to GND with minimum distance. Connect FREQ resistor, COMP component, MODE, TRACK/SS component, FB resistor to this pin as needed.

**V<sub>OUT</sub> (C1, D1–D2, E1–E2):** Power Output Pins. Apply output load between these pins and GND pins. Recommend placing output decoupling capacitance directly between these pins and GND pins.

**PGOOD (C2):** Output Power Good with Open-Drain Logic. PGOOD is pulled to ground when the voltage on the FB pin is not within  $\pm 10\%$  of the internal 0.6V reference.

**MODE (C4):** Operation Mode Select. Tie this pin to INTV<sub>CC</sub> to force continuous synchronous operation at all output loads. Tying it to SGND enables discontinuous mode operation at light loads. Do not leave floating.

**SV<sub>IN</sub> (C5):** Signal V<sub>IN</sub>. Filtered input voltage to the on-chip 3.3V regulator. Tie this pin to the V<sub>IN</sub> pin in most applications. Connect SV<sub>IN</sub> to an external voltage supply of at least 4V which must also be greater than V<sub>OUT</sub>.

**V<sub>IN</sub> (D5, E5):** Power Input Pins. Apply input voltage between these pins and GND pins. Recommend placing input decoupling capacitance directly between V<sub>IN</sub> pins and GND pins.

**INTV<sub>CC</sub> (E4):** Internal 3.3V Regulator Output. The internal power drivers and control circuits are powered from this voltage. This pin is internally decoupled to GND with a 1 $\mu$ F low ESR ceramic capacitor.

## BLOCK DIAGRAM

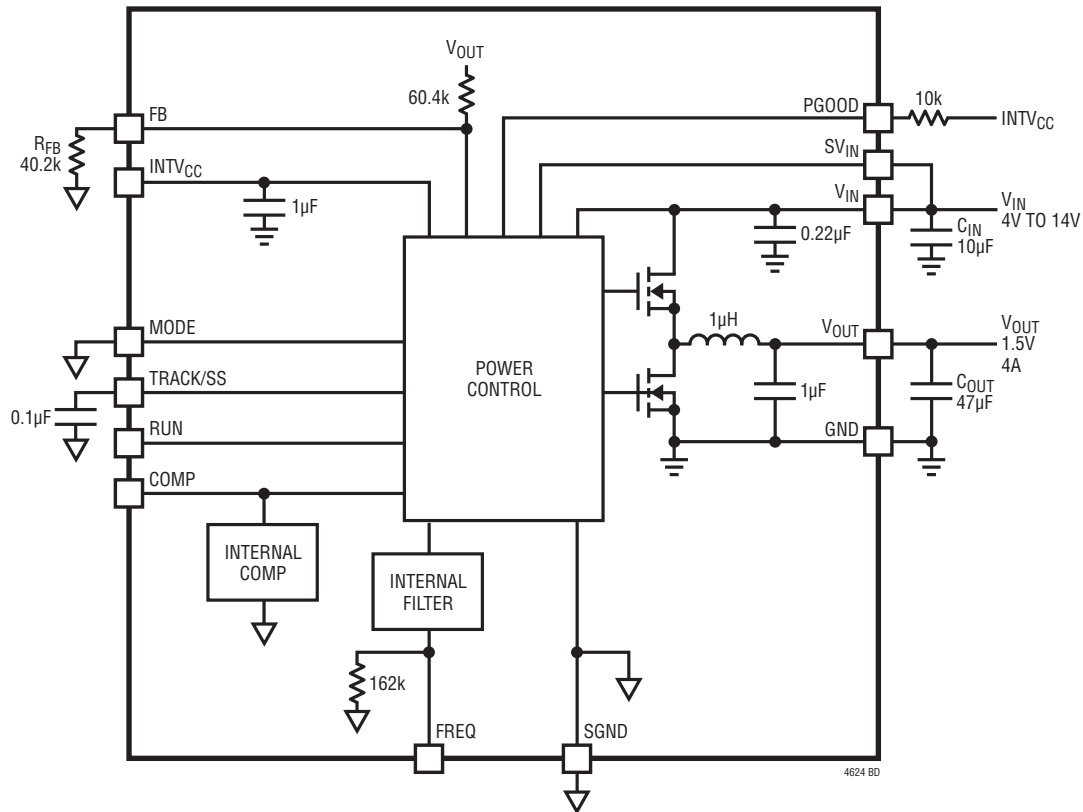

Figure 1. Simplified LTM4624 Block Diagram

## DECOUPLING REQUIREMENTS

| SYMBOL    | PARAMETER   | CONDITIONS     | MIN | TYP | MAX | UNITS   |
|-----------|---|----------------|-----|-----|-----|---------|
| $C_{IN}$  | External Input Capacitor Requirement ( $V_{IN} = 4V$ to $14V$ , $V_{OUT} = 1.5V$ )  | $I_{OUT} = 4A$ | 4.7 | 10  |     | $\mu F$ |
| $C_{OUT}$ | External Output Capacitor Requirement ( $V_{IN} = 4V$ to $14V$ , $V_{OUT} = 1.5V$ ) | $I_{OUT} = 4A$ | 22  | 47  |     | $\mu F$ |

## OPERATION

The LTM4624 is a standalone nonisolated switch mode DC/DC power supply. It can deliver up to 4A DC (5A peak) output current with few external input and output capacitors. This module provides precisely regulated output voltage adjustable between 0.6V to 5.5V via one external resistor over a 4V to 14V input voltage range. With an external bias supply, this module operates with an input voltage down to 2.375V. The typical application schematic is shown in Figure 18.

The LTM4624 contains an integrated constant on-time valley current mode regulator, power MOSFETs, inductor, and other supporting discrete components. The default switching frequency is 1MHz. For noise-sensitive applications, the switching frequency can be adjusted by external resistors. See the Applications Information section.

With current mode control and internal feedback loop compensation, the LTM4624 module has sufficient stability margins and good transient performance with a wide range of output capacitors, even with all ceramic output capacitors.

Current mode control provides cycle-by-cycle fast current limiting. Foldback current limiting is provided in an overcurrent condition indicated by a drop in  $V_{FB}$  reducing inductor valley current to approximately 40% of the original value. Internal output overvoltage and undervoltage comparators pull the open-drain PGOOD output low if the output feedback voltage exits a  $\pm 10\%$  window around the regulation point. Continuous operation is forced during OV and UV conditions except during start-up when the TRACK pin is ramping up to 0.6V

Pulling the RUN pin below 1.1V forces the controller into its shutdown state, turning off both power MOSFETs and most of the internal control circuitry. At light load currents, discontinuous mode (DCM) operation can be enabled to achieve higher efficiency compared to continuous mode (CCM) by pulling the MODE pin to SGND. The TRACK/SS pin is used for power supply tracking and soft-start programming. See the Applications Information section.



## APPLICATIONS INFORMATION

The typical LTM4624 application circuit is shown in Figure 18. External component selection is primarily determined by the input voltage, the output voltage and the maximum load current. Refer to Table 6 for specific external capacitor requirements for a particular application.

### $V_{IN}$ to $V_{OUT}$ Step-Down Ratios

There are restrictions in the maximum  $V_{IN}$  and  $V_{OUT}$  step-down ratios that can be achieved for a given input voltage due to the minimum off-time and minimum on-time limits of the regulator. The minimum off-time limit imposes a maximum duty cycle which can be calculated as:

$$D_{MAX} = 1 - (t_{OFF(MIN)} \cdot f_{SW})$$

where  $t_{OFF(MIN)}$  is the minimum off-time, typically 70ns for LTM4624, and  $f_{SW}$  (Hz) is the switching frequency. Conversely the minimum on-time limit imposes a minimum duty cycle of the converter which can be calculated as:

$$D_{MIN} = t_{ON(MIN)} \cdot f_{SW}$$

where  $t_{ON(MIN)}$  is the minimum on-time, typically 40ns for LTM4624. In the rare cases where the minimum duty cycle is surpassed, the output voltage will still remain in regulation, but the switching frequency will decrease from its programmed value. Note that additional thermal derating may be applied. See the Thermal Considerations and Output Current Derating section in this data sheet.

### Output Voltage Programming

The PWM controller has an internal 0.6V reference voltage. As shown in the Block Diagram, a 60.4k internal feedback resistor connects the  $V_{OUT}$  and FB pins together. Adding a resistor,  $R_{FB}$ , from FB pin to SGND programs the output voltage:

$$R_{FB} = \frac{0.6V}{V_{OUT} - 0.6V} \cdot 60.4k$$

**Table 1.  $R_{FB}$  Resistor Table vs Various Output Voltages**

| $V_{OUT}$ (V)          | 0.6  | 1.0  | 1.2  | 1.5  | 1.8  | 2.5  | 3.3  | 5.0  |
|------------------------|------|------|------|------|------|------|------|------|
| $R_{FB}$ (k $\Omega$ ) | OPEN | 90.9 | 60.4 | 40.2 | 30.1 | 19.1 | 13.3 | 8.25 |

### Input Decoupling Capacitors

The LTM4624 module should be connected to a low AC impedance DC source. For the regulator, a 10 $\mu$ F input ceramic capacitor is required for RMS ripple current decoupling. Bulk input capacitance is only needed when the input source impedance is compromised by long inductive leads, traces or not enough source capacitance. The bulk capacitor can be an aluminum electrolytic capacitor or polymer capacitor.

Without considering the inductor ripple current, the RMS current of the input capacitor can be estimated as:

$$I_{CIN(RMS)} = \frac{I_{OUT(MAX)}}{\eta\%} \cdot \sqrt{D \cdot (1 - D)}$$

where  $\eta\%$  is the estimated efficiency of the power module.

### Output Decoupling Capacitors

With an optimized high frequency, high bandwidth design, only a single low ESR output ceramic capacitor is required for the LTM4624 to achieve low output ripple voltage and very good transient response. Additional output filtering may be required by the system designer if further reduction of output ripple or dynamic transient spikes is required. Table 6 shows a matrix of different output voltages and output capacitors to minimize the voltage droop and overshoot during a 1A and 2A load-step transient. The Analog Devices LTpowerCAD<sup>®</sup> design tool is available to download online for output ripple, stability and transient response analysis for further optimization.

## APPLICATIONS INFORMATION

### Discontinuous Current Mode (DCM)

In applications where low output ripple and high efficiency at intermediate current are desired, discontinuous current mode (DCM) should be used by connecting the MODE pin to SGND. At light loads the internal current comparator may remain tripped for several cycles and force the top MOSFET to stay off for several cycles, thus skipping cycles. The inductor current does not reverse in this mode.

### Forced Continuous Current Mode (CCM)

In applications where fixed frequency operation is more critical than low current efficiency, and where the lowest output ripple is desired, forced continuous operation should be used. Forced continuous operation can be enabled by tying the MODE pin to INTV<sub>CC</sub>. In this mode, inductor current is allowed to reverse during low output loads, the COMP voltage is in control of the current comparator threshold throughout, and the top MOSFET always turns on with each oscillator pulse. During start-up, forced continuous mode is disabled and inductor current is prevented from reversing until the LTM4624's output voltage is in regulation.

### Operating Frequency

The operating frequency of the LTM4624 is optimized to achieve the compact package size and the minimum out-put ripple voltage while still keeping high efficiency. The default operating frequency is internally set to 1MHz. In most applications, no additional frequency adjusting is required.

If any operating frequency other than 1MHz is required by application, the operating frequency can be increased by adding a resistor, R<sub>FSET</sub>, between the FREQ pin and SGND, as shown in Figure 18. The operating frequency can be calculated as:

$$f(\text{Hz}) = \frac{1.6e11}{162k \parallel R_{FSET} (\Omega)}$$

The operating frequency can also be decreased by adding a resistor between the FREQ pin and INTV<sub>CC</sub>, calculated as:

$$f(\text{Hz}) = 1\text{MHz} - \frac{2.8e11}{R_{FSET} (\Omega)}$$

The programmable operating frequency range is from 800kHz to 4MHz.

### Soft-Start And Output Voltage Tracking

The TRACK/SS pin provides a means to either soft start the regulator or track it to a different power supply. A capacitor on the TRACK/SS pin will program the ramp rate of the output voltage. An internal 2.5μA current source will charge up the external soft-start capacitor towards INTV<sub>CC</sub> voltage. When the TRACK/SS voltage is below 0.6V, it will take over the internal 0.6V reference voltage to control the output voltage. The total soft-start time can be calculated as:

$$t_{SS} = 0.6 \cdot \frac{C_{SS}}{2.5\mu\text{A}}$$

where C<sub>SS</sub> is the capacitance on the TRACK/SS pin. Current foldback and forced continuous mode are disabled during the soft-start process.

## APPLICATIONS INFORMATION

Output voltage tracking can also be programmed externally using the TRACK/SS pin. The output can be tracked up and down with another regulator. Figure 2 and Figure 3 show an example waveform and schematic of ratiometric tracking where the subordinate regulator's output slew rate is proportional to the main's.

Since the subordinate regulator's TRACK/SS is connected to the main's output through a  $R_{TR(TOP)}/R_{TR(BOT)}$  resistor divider and its voltage used to regulate the subordinate output voltage when TRACK/SS voltage is below 0.6V, the

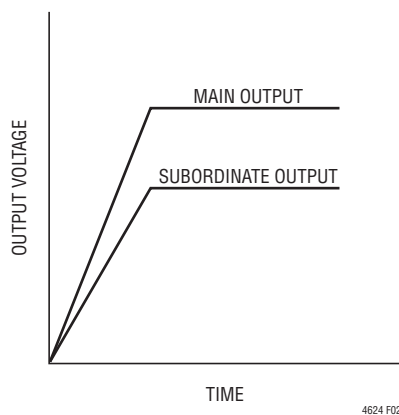

Figure 2. Output Ratiometric Tracking Waveform

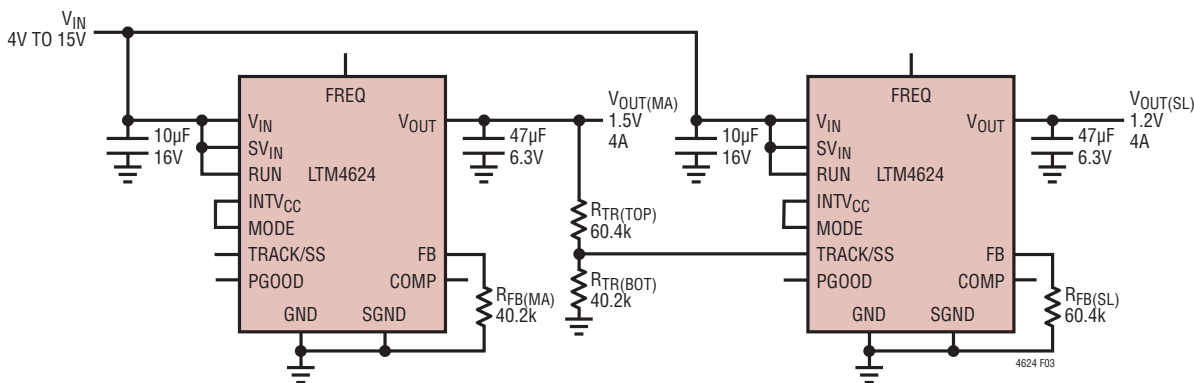

Figure 3. Example Schematic of Ratiometric Output Voltage Tracking

## APPLICATIONS INFORMATION

subordinate output voltage and the main output voltage should satisfy the following equation during start-up:

$$V_{OUT(SL)} \cdot \frac{R_{FB(SL)}}{R_{FB(SL)} + 60.4k} =$$

$$V_{OUT(MA)} \cdot \frac{R_{TR(BOT)}}{R_{TR(TOP)} + R_{TR(BOT)}}$$

The  $R_{FB(SL)}$  is the feedback resistor and the  $R_{TR(TOP)}/R_{TR(BOT)}$  is the resistor divider on the TRACK/SS pin of the subordinate regulator, as shown in Figure 3.

Following the previous equation, the ratio of the main's output slew rate (MR) to the subordinate's output slew rate (SR) is determined by:

$$\frac{MR}{SR} = \frac{\frac{R_{FB(SL)}}{R_{FB(SL)} + 60.4k}}{\frac{R_{TR(BOT)}}{R_{TR(TOP)} + R_{TR(BOT)}}$$

For example,  $V_{OUT(MA)}=1.5V$ ,  $MR = 1.5V/1ms$  and  $V_{OUT(SL)} = 1.2V$ ,  $SR = 1.2V/1ms$  as shown in Figure 5. From the equation, we could solve that  $R_{TR(TOP)} = 60.4k$  and  $R_{TR(BOT)} = 40.2k$  are a good combination for the ratio-metric tracking.

The TRACK/SS pin will have the  $2.5\mu A$  current source on when a resistive divider is used to implement tracking on the subordinate regulator. This will impose an offset on the TRACK/SS pin input. Smaller value resistors with the same ratios as the resistor values calculated from the above equation can be used. For example, where the  $60.4k$  is used then a  $6.04k$  can be used to reduce the TRACK/SS pin offset to a negligible value.

The coincident output tracking can be recognized as a special ratiometric output tracking in which the main's output slew rate (MR) is the same as the subordinate's output slew rate (SR), waveform as shown in Figure 4.

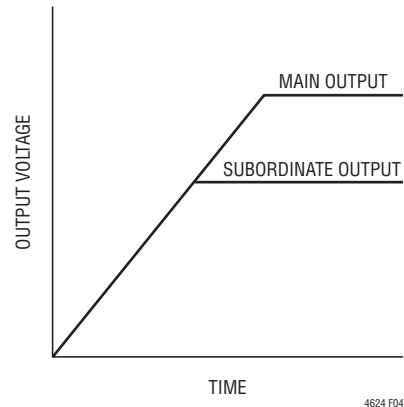

Figure 4. Output Coincident Tracking Waveform

From the equation, we could easily find that, in coincident tracking, the subordinate regulator's TRACK/SS pin resistor divider is always the same as its feedback divider:

$$\frac{R_{FB(SL)}}{R_{FB(SL)} + 60.4k} = \frac{R_{TR(BOT)}}{R_{TR(TOP)} + R_{TR(BOT)}}$$

For example,  $R_{TR(TOP)} = 60.4k$  and  $R_{TR(BOT)} = 60.4k$  is a good combination for coincident tracking for a  $V_{OUT(MA)} = 1.5V$  and  $V_{OUT(SL)} = 1.2V$  application.

### Power Good

The PGOOD pin is an open-drain pin that can be used to monitor valid output voltage regulation. This pin is pulled low when the output voltage exceeds a  $\pm 10\%$  window around the regulation point. To prevent unwanted PGOOD glitches during transients or dynamic  $V_{OUT}$  changes, the LTM4624's PGOOD falling edge includes a blanking delay of approximately 52 switching cycles.

### Stability Compensation

The LTM4624's internal compensation loop is designed and optimized for use with low ESR ceramic output capacitors. Figure 5 is provided for most application requirements. In case a bulk output capacitor is required for output ripple or dynamic transient spike reduction, an additional  $10pF$  to  $15pF$  feedforward capacitor ( $C_{FF}$ ) is needed between the  $V_{OUT}$  and FB pins. The LTpowerCAD design tool is available for control loop optimization.

## APPLICATIONS INFORMATION

### RUN Enable

Pulling the RUN pin to ground forces the LTM4624 into its shutdown state, turning off both power MOSFETs and most of its internal control circuitry. Bringing the RUN pin above 0.7V turns on the internal reference only, while still keeping the power MOSFETs off. Increasing the RUN pin voltage above 1.25V will turn on the entire chip.

### Pre-Biased Output Start-Up

There may be situations that require the power supply to start up with some charge on the output capacitors. The LTM4624 can safely power up into a pre-biased output without discharging it.

The LTM4624 accomplishes this by forcing discontinuous mode (DCM) operation until the TRACK/SS pin voltage reaches 0.6V reference voltage. This will prevent the BG from turning on during the pre-biased output start-up which would discharge the output.

Do not pre-bias LTM4624 with an output voltage above  $INTV_{CC}$  voltage (3.3V) or set voltage by FB resistor whichever is lower.

### Overtemperature Protection

The internal overtemperature protection monitors the junction temperature of the module. If the junction temperature reaches approximately 160°C, both power switches will be turned off until the temperature drops about 15°C cooler.

### Low Input Application

The LTM4624 module has a separate  $SV_{IN}$  pin which makes it suitable for low input voltage applications down to 2.375V. The  $SV_{IN}$  pin is the single input of the whole control circuitry while the  $V_{IN}$  pin is the power input which directly connects to the drain of the top MOSFET. In most applications where  $V_{IN}$  is greater than 4V, connect  $SV_{IN}$  directly to  $V_{IN}$  with a short trace. An optional filter, consisting of a resistor (1Ω to 10Ω) between  $SV_{IN}$  and  $V_{IN}$  along with a 0.1μF bypass capacitor between  $SV_{IN}$  and ground, can be placed for additional noise immunity. This filter is not necessary in most cases if good PCB

layout practices are followed (see Figure 17). In a low input voltage (2.375V to 4V) application, or to reduce power dissipation by the internal bias LDO, connect  $SV_{IN}$  to an external voltage higher than 4V with a 0.1μF local bypass capacitor. Figure 19 shows an example of a low input voltage application. Please note the  $SV_{IN}$  voltage cannot go below the  $V_{OUT}$  voltage.

### Thermal Considerations and Output Current Derating

The thermal resistances reported in the Pin Configuration section of the data sheet are consistent with those parameters defined by JESD 51-12 and are intended for use with finite element analysis (FEA) software modeling tools that leverage the outcome of thermal modeling, simulation, and correlation to hardware evaluation performed on a μModule package mounted to a hardware test board. The motivation for providing these thermal coefficients is found in JESD 51-12 (Guidelines for Reporting and Using Electronic Package Thermal Information).

Many designers may opt to use laboratory equipment and a test vehicle such as the demo board to anticipate the μModule regulator's thermal performance in their application at various electrical and environmental operating conditions to compliment any FEA activities. Without FEA software, the thermal resistances reported in the Pin Configuration section are, in and of themselves, not relevant to providing guidance of thermal performance; instead, the derating curves provided in this data sheet can be used in a manner that yields insight and guidance pertaining to one's application usage, and can be adapted to correlate thermal performance to one's own application.

The Pin Configuration section gives four thermal coefficients explicitly defined in JESD 51-12; these coefficients are quoted or paraphrased below:

1.  $\theta_{JA}$ , the thermal resistance from junction to ambient, is the natural convection junction-to-ambient air thermal resistance measured in a one cubic foot sealed enclosure. This environment is sometimes referred to as "still air" although natural convection causes the air to move. This value is determined with the part mounted to a 95mm × 76mm PCB with four layers.

## APPLICATIONS INFORMATION

2.  $\theta_{JCbottom}$ , the thermal resistance from junction to the bottom of the product case, is determined with all of the component power dissipation flowing through the bottom of the package. In the typical  $\mu$ Module regulator, the bulk of the heat flows out the bottom of the package, but there is always heat flow out into the ambient environment. As a result, this thermal resistance value may be useful for comparing packages, but the test conditions don't generally match the user's application.
3.  $\theta_{JCtop}$ , the thermal resistance from junction to top of the product case, is determined with nearly all of the component power dissipation flowing through the top of the package. As the electrical connections of the typical  $\mu$ Module regulator are on the bottom of the package, it is rare for an application to operate such that most of the heat flows from the junction to the top of the part. As in the case of  $\theta_{JCbottom}$ , this value may be useful for comparing packages but the test conditions don't generally match the user's application.
4.  $\theta_{JB}$ , the thermal resistance from junction to the printed circuit board, is the junction-to-board thermal resistance where almost all of the heat flows through the bottom of the  $\mu$ Module package and into the board, and is really the sum of the  $\theta_{JCbottom}$  and the thermal resistance of the bottom of the part through the solder joints and through a portion of the board. The board temperature is measured a specified distance from the package.

A graphical representation of the aforementioned thermal resistances is given in Figure 5; blue resistances are contained within the  $\mu$ Module regulator, whereas green resistances are external to the  $\mu$ Module package.

As a practical matter, it should be clear to the reader that no individual or sub-group of the four thermal resistance parameters defined by JESD 51-12 or provided in the Pin Configuration section replicates or conveys normal operating conditions of a  $\mu$ Module regulator. For example, in normal board-mounted applications, never does 100% of the device's total power loss (heat) thermally conduct exclusively through the top or exclusively through bottom of the  $\mu$ Module package—as the standard defines for  $\theta_{JCtop}$  and  $\theta_{JCbottom}$ , respectively. In practice, power loss is thermally dissipated in both directions away from the package—granted, in the absence of a heat sink and airflow, a majority of the heat flow is into the board.

Within the LTM4624 be aware there are multiple power devices and components dissipating power, with a consequence that the thermal resistances relative to different junctions of components or die are not exactly linear with respect to total package power loss. To reconcile this complication without sacrificing modeling simplicity—but also, not ignoring practical realities—an approach has been taken using FEA software modeling along with laboratory testing in a controlled environment chamber to reasonably define and correlate the thermal resistance

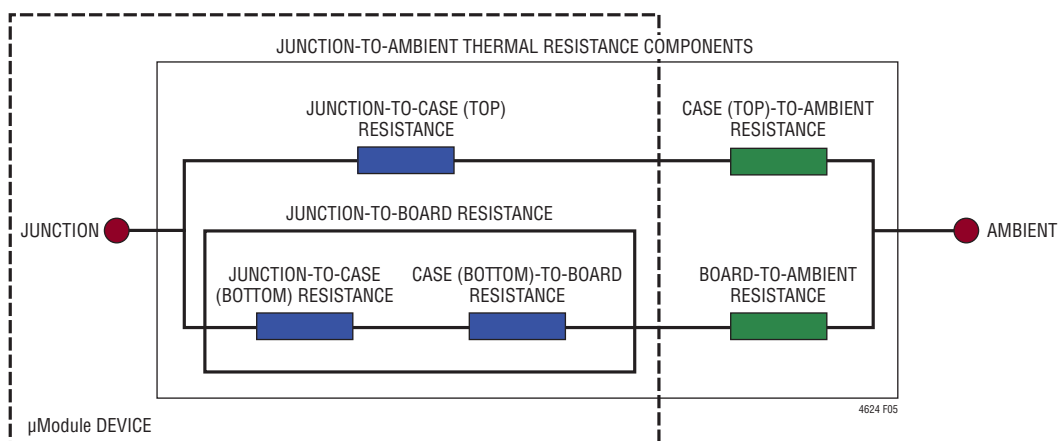

Figure 5. Graphical Representation of JESD 51-12 Thermal Coefficients

## APPLICATIONS INFORMATION

values supplied in this data sheet: (1) Initially, FEA software is used to accurately build the mechanical geometry of the LTM4624 and the specified PCB with all of the correct material coefficients along with accurate power loss source definitions; (2) this model simulates a software-defined JEDEC environment consistent with JSED 51-12 to predict power loss heat flow and temperature readings at different interfaces that enable the calculation of the JEDEC-defined thermal resistance values; (3) the model and FEA software is used to evaluate the LTM4624 with heat sink and airflow; (4) having solved for and analyzed these thermal resistance values and simulated various operating conditions in the software model, a thorough laboratory evaluation replicates the simulated conditions with thermocouples within a controlled environment chamber while operating the device at the same power loss as that which was simulated. An outcome of this process and due diligence yields the set of derating curves shown in this data sheet. After these laboratory tests have been performed and correlated to the LTM4624 model, then the  $\theta_{JB}$  and  $\theta_{BA}$  are summed together to provide a value that should closely equal the  $\theta_{JA}$  value because approximately 100% of power loss flows from the junction through the board into ambient with no airflow or top mounted heat sink.

The 1.0V, 1.5V, 3.3V and 5V power loss curves in Figure 6 through Figure 9 can be used in coordination with the load current derating curves in Figure 10 through Figure 16 for calculating an approximate  $\theta_{JA}$  thermal resistance for the LTM4624 with various airflow conditions. The power loss curves are taken at room temperature, and are increased with a multiplicative factor according to the ambient temperature. This approximate factor is: 1.4 for 120°C at junction temperature. Maximum load current is achievable while increasing ambient temperature as long as the junction temperature is less than 120°C, which is a 5°C guard band from maximum junction temperature of 125°C. When the ambient temperature reaches a point where the junction temperature is 120°C, then the load current is lowered to maintain the junction at 120°C while increasing ambient temperature up to 120°C.

The derating curves are plotted with the output current starting at 4A and the ambient temperature at 30°C. The output voltages are 1.0V, 1.5V, 3.3V and 5V. These are chosen to include the lower and higher output voltage ranges for correlating the thermal resistance. Thermal models are derived from several temperature measurements in a controlled temperature chamber along with thermal modeling analysis. The junction temperatures are monitored while ambient temperature is increased with and without airflow. The power loss increase with ambient temperature change is factored into the derating curves. The junctions are maintained at 120°C maximum while lowering output current or power with increasing ambient temperature. The decreased output current will decrease the internal module loss as ambient temperature is increased. The monitored junction temperature of 120°C minus the ambient operating temperature specifies how much module temperature rise can be allowed. As an example, in Figure 11 the load current is derated to ~3A at ~95°C with no air flow or heat sink and the power loss for the 12V to 1.0V at 3A output is about 1.15W. The 1.15W loss is calculated with the ~0.82W room temperature loss from the 12V to 1.0V power loss curve at 3A, and the 1.4 multiplying factor at 120°C junction temperature. If the 95°C ambient temperature is subtracted from the 120°C junction temperature, then the difference of 25°C divided by 1.15W equals a 22°C/W  $\theta_{JA}$  thermal resistance. Table 2 specifies a 22°C/W value which is very close. Table 3, Table 4 and Table 5 provide equivalent thermal resistances for 1.5V 3.3V and 5V outputs with and without airflow and heat sinking. The derived thermal resistances in Table 3, Table 4 and Table 5 for the various conditions can be multiplied by the calculated power loss as a function of ambient temperature to derive temperature rise above ambient, thus maximum junction temperature. Room temperature power loss can be derived from the efficiency curves in the Typical Performance Characteristics section and adjusted with the above ambient temperature multiplicative factors. The printed circuit board is a 1.6mm thick 4-layer board with two ounce copper for the two outer layers and one ounce copper for the two inner layers. The PCB dimensions are 95mm × 76mm.

## APPLICATIONS INFORMATION

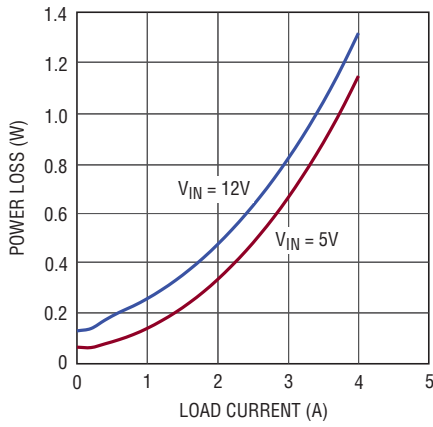

Figure 6. 1V Loss

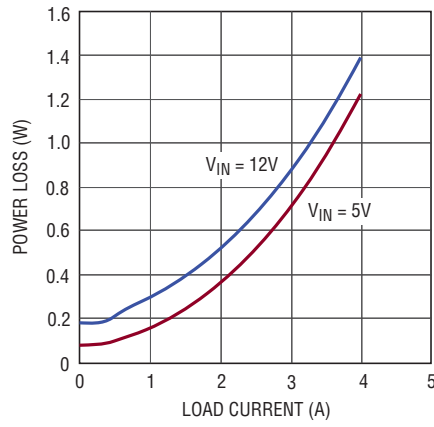

Figure 7. 1.5V Loss

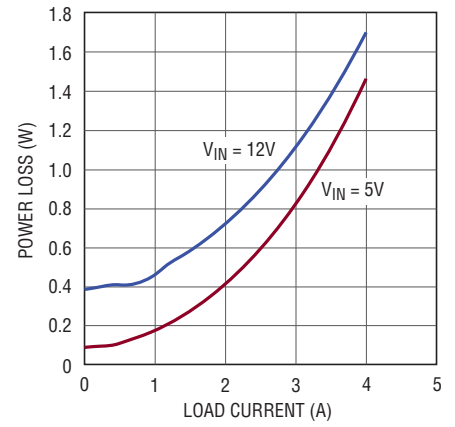

Figure 8. 3.3V Loss

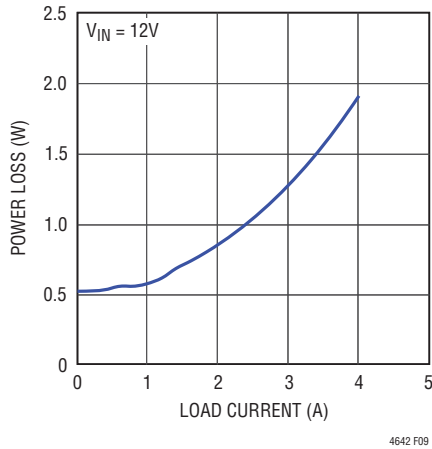

Figure 9. 5V Loss

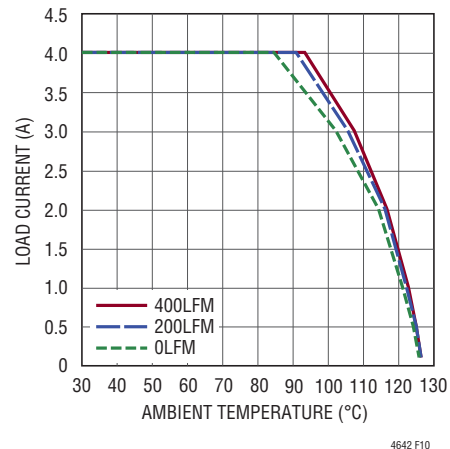

Figure 10. 5V to 1V Derating Curve, No Heat Sink

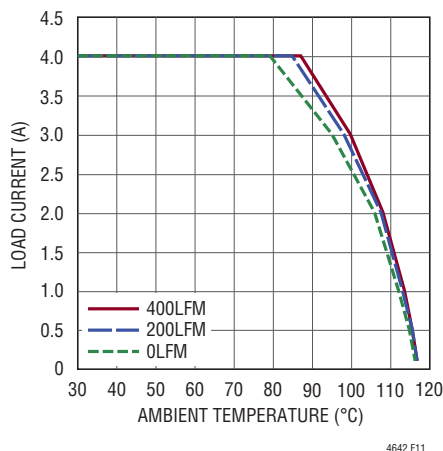

Figure 11. 12V to 1V Derating Curve, No Heat Sink

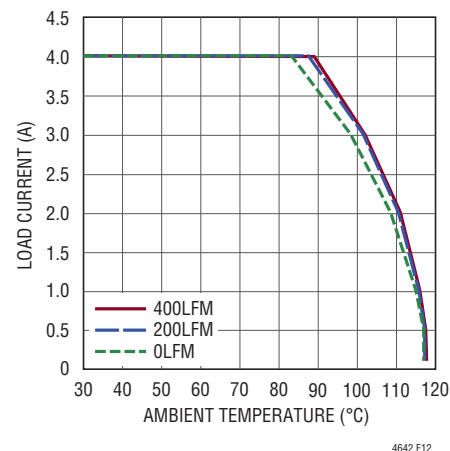
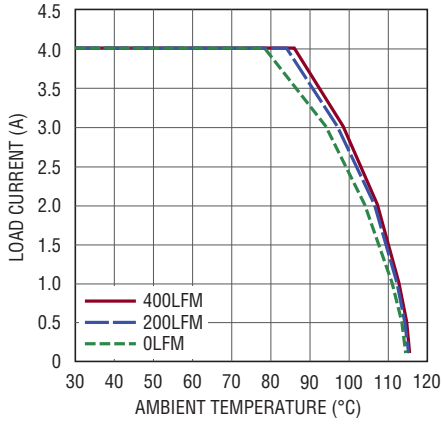

Figure 12. 5V to 1.5V Derating Curve, No Heat Sink



# APPLICATIONS INFORMATION



**Figure 13. 12V to 1.5V Derating Curve, No Heat Sink**

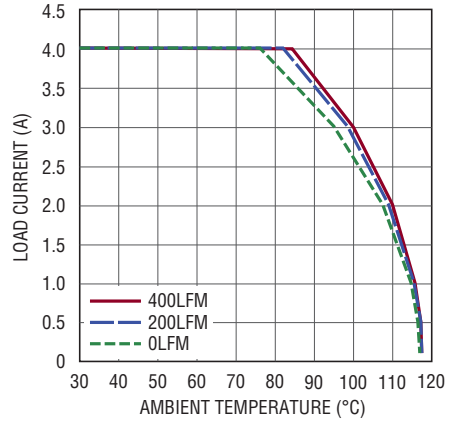

**Figure 14. 5V to 3.3V Derating Curve, No Heat Sink**

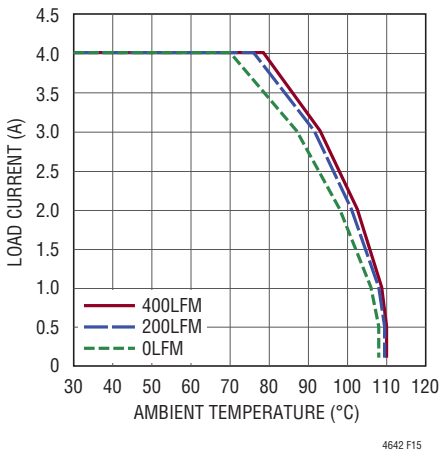

**Figure 15. 12V to 3.3V Derating Curve, No Heat Sink**

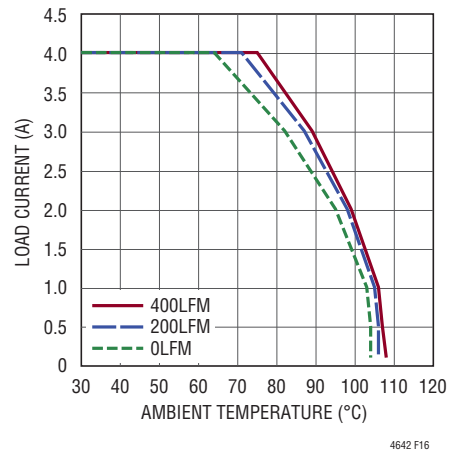

**Figure 16. 12V to 5V Derating Curve, No Heat Sink**

**Table 2. 1V Output**

| DERATING CURVE       | V <sub>IN</sub> (V) | POWER LOSS CURVE | AIRFLOW (LFM) | HEAT SINK | θ <sub>JA</sub> (°C/W) |
|----------------------|---------------------|------------------|---------------|-----------|------------------------|
| Figure 10, Figure 11 | 5, 12               | Figure 6         | 0             | None      | 22                     |
| Figure 10, Figure 11 | 5, 12               | Figure 6         | 200           | None      | 19                     |
| Figure 10, Figure 11 | 5, 12               | Figure 6         | 400           | None      | 18                     |

**Table 3. 1.5V Output**

| DERATING CURVE       | V <sub>IN</sub> (V) | POWER LOSS CURVE | AIRFLOW (LFM) | HEAT SINK | θ <sub>JA</sub> (°C/W) |
|----------------------|---------------------|------------------|---------------|-----------|------------------------|
| Figure 12, Figure 13 | 5, 12               | Figure 7         | 0             | None      | 22                     |
| Figure 12, Figure 13 | 5, 12               | Figure 7         | 200           | None      | 19                     |
| Figure 12, Figure 13 | 5, 12               | Figure 7         | 400           | None      | 18                     |

**Table 4. 3.3V Output**

| DERATING CURVE       | V <sub>IN</sub> (V) | POWER LOSS CURVE | AIRFLOW (LFM) | HEAT SINK | θ <sub>JA</sub> (°C/W) |
|----------------------|---------------------|------------------|---------------|-----------|------------------------|
| Figure 14, Figure 15 | 5, 12               | Figure 8         | 0             | None      | 22                     |
| Figure 14, Figure 15 | 5, 12               | Figure 8         | 200           | None      | 19                     |
| Figure 14, Figure 15 | 5, 12               | Figure 8         | 400           | None      | 18                     |

**Table 5. 5V Output**

| DERATING CURVE | V <sub>IN</sub> (V) | POWER LOSS CURVE | AIRFLOW (LFM) | HEAT SINK | θ <sub>JA</sub> (°C/W) |
|----------------|---------------------|------------------|---------------|-----------|------------------------|
| Figure 16      | 12                  | Figure 9         | 0             | None      | 22                     |
| Figure 16      | 12                  | Figure 9         | 200           | None      | 19                     |
| Figure 16      | 12                  | Figure 9         | 400           | None      | 18                     |

## APPLICATIONS INFORMATION

**Table 6. Output Voltage Response vs Component Matrix (Refer to Figure 20)**

| C <sub>IN</sub> | PART NUMBER        | VALUE                      | C <sub>OUT1</sub> | PART NUMBER       | VALUE                       | C <sub>OUT2</sub> | PART NUMBER | VALUE          |
|-----------------|--------------------|----------------------------|-------------------|-------------------|-----------------------------|-------------------|-------------|----------------|
| Murata          | GRM21BR61C106KE15L | 10 $\mu$ F, 16V, 0805, X5R | Murata            | GRM21BR60J476ME15 | 47 $\mu$ F, 6.3V, 0805, X5R | Sanyo             | 4TPE100MZB  | 4V 100 $\mu$ F |
| Taiyo Yuden     | EMK212BJ106KG-T    | 10 $\mu$ F, 16V, 0805, X5R | Taiyo Yuden       | JMK212BJ476MG-T   | 47 $\mu$ F, 6.3V, 0805, X5R |                   |             |                |
| Murata          | GRM31CR61C226ME15L | 22 $\mu$ F, 16V, 1206, X5R |                   |                   |                             |                   |             |                |
| Taiyo Yuden     | EMK316BJ226ML-T    | 22 $\mu$ F, 16V, 1206, X5R |                   |                   |                             |                   |             |                |

| V <sub>OUT</sub> (V) | C <sub>IN</sub> (CERAMIC) ( $\mu$ F) | C <sub>IN</sub> (BULK) | C <sub>OUT1</sub> (CERAMIC) ( $\mu$ F) | C <sub>OUT2</sub> (BULK) ( $\mu$ F) | C <sub>FF</sub> (pF) | V <sub>IN</sub> (V) | DROOP (mV) | P-P DERIVATION (mV) | RECOVERY TIME ( $\mu$ s) | LOAD STEP (A) | LOAD STEP SLEW RATE (A/ $\mu$ s) | R <sub>FB</sub> (k $\Omega$ ) |
|----------------------|--------------------------------------|------------------------|--|-------------------------------------|----------------------|---------------------|------------|---------------------|--------------------------|---------------|----------------------------------|-------------------------------|
| 1                    | 10                                   |                        | 47                                     |                                     |                      | 5, 12               | 5          | 72                  | 40                       | 1             | 1                                | 90.9                          |
| 1                    | 10                                   |                        |  | 100                                 | 10                   | 5, 12               | 5          | 60                  | 40                       | 1             | 1                                | 90.9                          |
| 1                    | 10                                   |                        | 47                                     |                                     |                      | 5, 12               | 5          | 127                 | 40                       | 2             | 1                                | 90.9                          |
| 1                    | 10                                   |                        |  | 100                                 | 10                   | 5, 12               | 5          | 90                  | 40                       | 2             | 1                                | 90.9                          |
| 1.2                  | 10                                   |                        | 47                                     |                                     |                      | 5, 12               | 5          | 76                  | 40                       | 1             | 1                                | 60.4                          |
| 1.2                  | 10                                   |                        |  | 100                                 | 10                   | 5, 12               | 5          | 65                  | 40                       | 1             | 1                                | 60.4                          |
| 1.2                  | 10                                   |                        | 47                                     |                                     |                      | 5, 12               | 5          | 145                 | 40                       | 2             | 1                                | 60.4                          |
| 1.2                  | 10                                   |                        |  | 100                                 | 10                   | 5, 12               | 5          | 103                 | 40                       | 2             | 1                                | 60.4                          |
| 1.5                  | 10                                   |                        | 47                                     |                                     |                      | 5, 12               | 5          | 80                  | 40                       | 1             | 1                                | 40.2                          |
| 1.5                  | 10                                   |                        |  | 100                                 | 10                   | 5, 12               | 5          | 70                  | 40                       | 1             | 1                                | 40.2                          |
| 1.5                  | 10                                   |                        | 47                                     |                                     |                      | 5, 12               | 5          | 161                 | 40                       | 2             | 1                                | 40.2                          |
| 1.5                  | 10                                   |                        |  | 100                                 | 10                   | 5, 12               | 5          | 115                 | 40                       | 2             | 1                                | 40.2                          |
| 1.8                  | 10                                   |                        | 47                                     |                                     |                      | 5, 12               | 5          | 95                  | 40                       | 1             | 1                                | 30.1                          |
| 1.8                  | 10                                   |                        |  | 100                                 | 10                   | 5, 12               | 5          | 80                  | 40                       | 1             | 1                                | 30.1                          |
| 1.8                  | 10                                   |                        | 47                                     |                                     |                      | 5, 12               | 5          | 177                 | 40                       | 2             | 1                                | 30.1                          |
| 1.8                  | 10                                   |                        |  | 100                                 | 10                   | 5, 12               | 5          | 128                 | 40                       | 2             | 1                                | 30.1                          |
| 2.5                  | 10                                   |                        | 47                                     |                                     |                      | 5, 12               | 5          | 125                 | 40                       | 1             | 1                                | 19.1                          |
| 2.5                  | 10                                   |                        |  | 100                                 | 10                   | 5, 12               | 5          | 100                 | 50                       | 1             | 1                                | 19.1                          |
| 2.5                  | 10                                   |                        | 47                                     |                                     |                      | 5, 12               | 5          | 225                 | 40                       | 2             | 1                                | 19.1                          |
| 2.5                  | 10                                   |                        |  | 100                                 | 10                   | 5, 12               | 5          | 161                 | 50                       | 2             | 1                                | 19.1                          |
| 3.3                  | 10                                   |                        | 47                                     |                                     |                      | 5, 12               | 5          | 155                 | 40                       | 1             | 1                                | 13.3                          |
| 3.3                  | 10                                   |                        |  | 100                                 | 10                   | 5, 12               | 5          | 122                 | 60                       | 1             | 1                                | 13.3                          |
| 3.3                  | 10                                   |                        | 47                                     |                                     |                      | 5, 12               | 5          | 285                 | 40                       | 2             | 1                                | 13.3                          |
| 3.3                  | 10                                   |                        |  | 100                                 | 10                   | 5, 12               | 5          | 198                 | 60                       | 2             | 1                                | 13.3                          |
| 5                    | 10                                   |                        | 47                                     |                                     |                      | 5, 12               | 5          | 220                 | 40                       | 1             | 1                                | 8.25                          |
| 5                    | 10                                   |                        | 47                                     |                                     |                      | 5, 12               | 5          | 420                 | 40                       | 2             | 1                                | 8.25                          |

## APPLICATIONS INFORMATION

### Safety Considerations

The LTM4624 modules do not provide galvanic isolation from  $V_{IN}$  to  $V_{OUT}$ . There is no internal fuse. If required, a slow blow fuse with a rating twice the maximum input current needs to be provided to protect each unit from catastrophic failure. The device does support thermal shutdown and over current protection.

### Layout Checklist/Example

The high integration of LTM4624 makes the PCB board layout very simple and easy. However, to optimize its electrical and thermal performance, some layout considerations are still necessary.

- Use large PCB copper areas for high current paths, including  $V_{IN}$ , GND and  $V_{OUT}$ . It helps to minimize the PCB conduction loss and thermal stress.

- Place high frequency ceramic input and output capacitors next to the  $V_{IN}$ , PGND and  $V_{OUT}$  pins to minimize high frequency noise.
- Place a dedicated power ground layer underneath the unit.
- To minimize the via conduction loss and reduce module thermal stress, use multiple vias for interconnection between top layer and other power layers.
- Do not put via directly on the pad, unless they are capped or plated over.
- Use a separated SGND ground copper area for components connected to signal pins. Connect the SGND to GND underneath the unit.
- Bring out test points on the signal pins for monitoring.

Figure 17 gives a good example of the recommended layout.

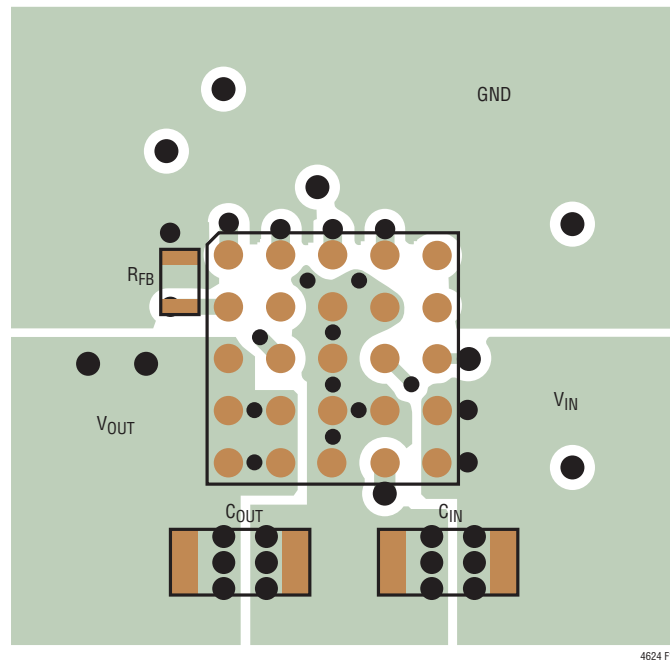
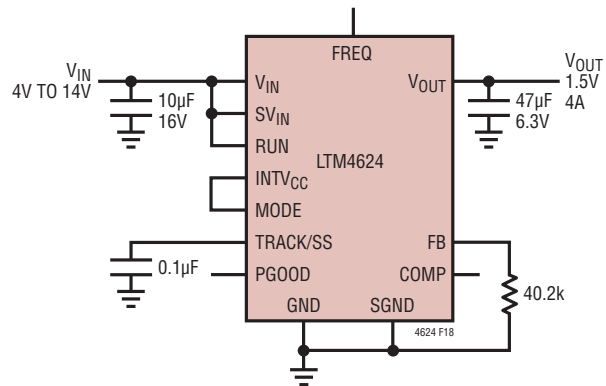
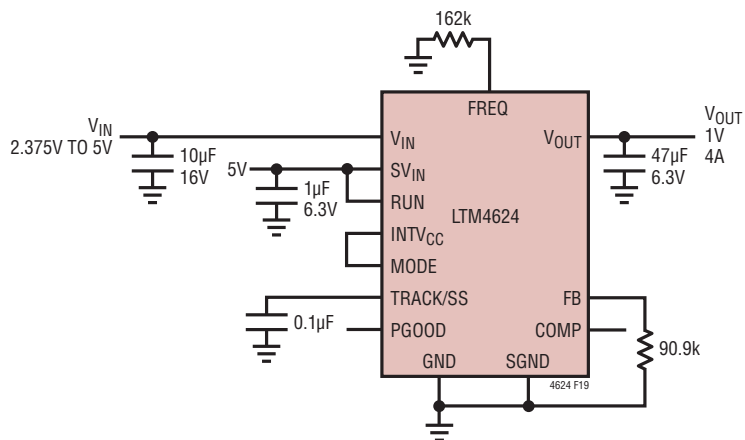

Figure 17. Recommended PCB Layout

## APPLICATIONS INFORMATION

Figure 18.  $4V_{IN}$  to  $14V_{IN}$ , 1.5V Output at 4A DesignFigure 19.  $2.375V_{IN}$  to  $5V_{IN}$ , 1V Output with 2MHz Operating Frequency

APPLICATIONS INFORMATION

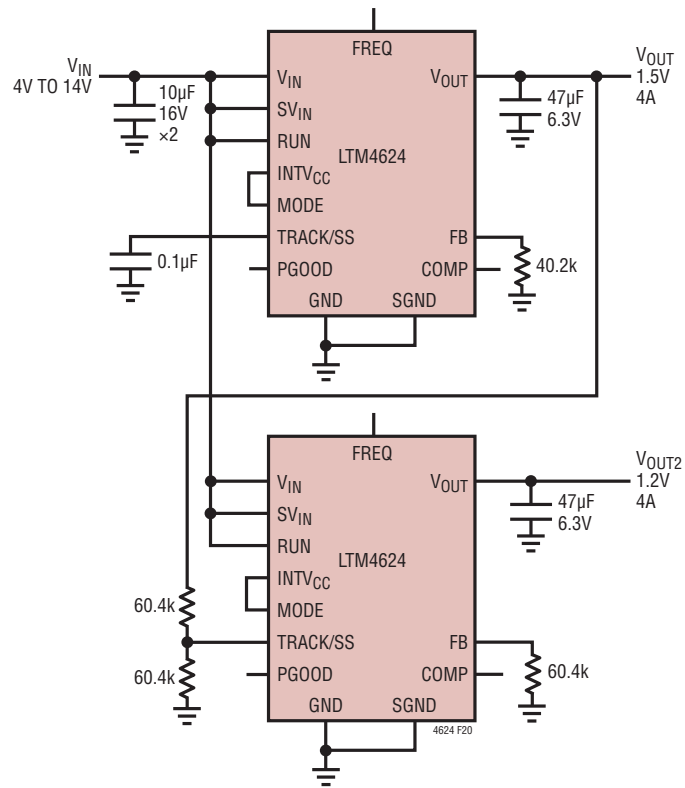

Figure 20.  $4V_{IN}$  to  $14V_{IN}$ , 1.2V and 1.5V with Coincident Tracking

## PACKAGE DESCRIPTION

Please refer to <http://www.adi.com/designtools/packaging/> for the most recent package drawings.



PACKAGE ROW AND COLUMN LABELING MAY VARY  
AMONG  $\mu$ Module PRODUCTS. REVIEW EACH PACKAGE  
LAYOUT CAREFULLY.

**Table 7. LTM4624 Component BGA Pinout**

| PIN ID | FUNCTION         | PIN ID | FUNCTION         | PIN ID | FUNCTION | PIN ID | FUNCTION           | PIN ID | FUNCTION         |
|--------|------------------|--------|------------------|--------|----------|--------|--------------------|--------|------------------|
| A1     | COMP             | A2     | TRACK/SS         | A3     | RUN      | A4     | FREQ               | A5     | NC               |
| B1     | FB               | B2     | NC               | B3     | GND      | B4     | SGND               | B5     | NC               |
| C1     | V <sub>OUT</sub> | C2     | PGOOD            | C3     | GND      | C4     | MODE               | C5     | SV <sub>IN</sub> |
| D1     | V <sub>OUT</sub> | D2     | V <sub>OUT</sub> | D3     | GND      | D4     | GND                | D5     | V <sub>IN</sub>  |
| E1     | V <sub>OUT</sub> | E2     | V <sub>OUT</sub> | E3     | GND      | E4     | INTV <sub>CC</sub> | E5     | V <sub>IN</sub>  |

## PACKAGE DESCRIPTION

Please refer to <http://www.adi.com/designtools/packaging/> for the most recent package drawings.

### BGA Package 25-Lead (6.25mm × 6.25mm × 5.01mm) (Reference LTC DWG # 05-08-1905 Rev C)

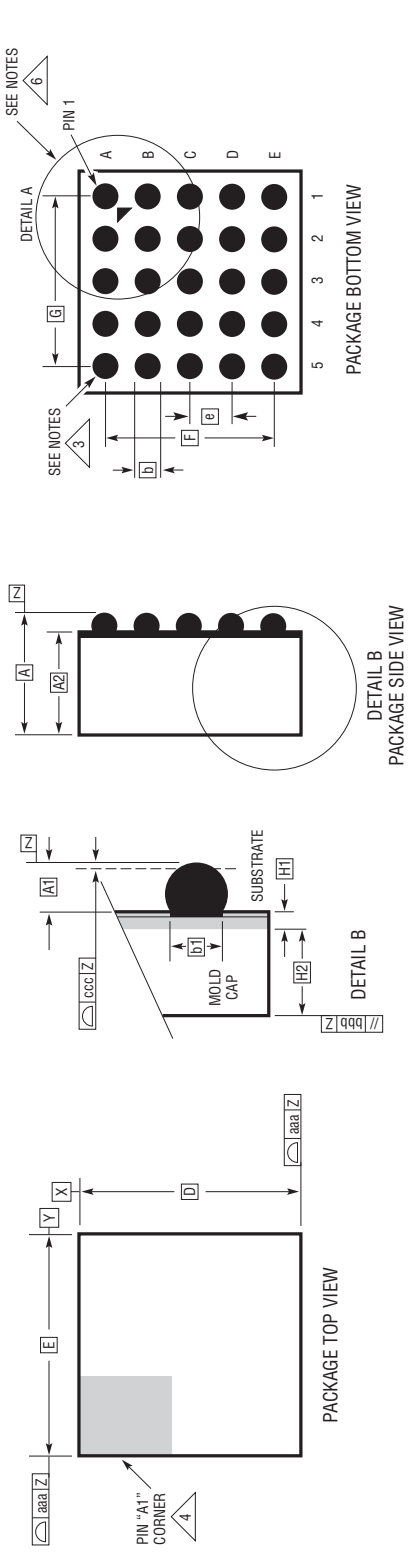

- NOTES:
1. DIMENSIONING AND TOLERANCING PER ASME Y14.5M-1994
  2. ALL DIMENSIONS ARE IN MILLIMETERS
  3. BALL DESIGNATION PER JESD MS-028 AND JEP95
  4. DETAILS OF PIN #1 IDENTIFIER ARE OPTIONAL, BUT MUST BE LOCATED WITHIN THE ZONE INDICATED. THE PIN #1 IDENTIFIER MAY BE EITHER A MOLD OR MARKED FEATURE
  5. PRIMARY DATUM - Z - IS SEATING PLANE
  6. PACKAGE ROW AND COLUMN LABELING MAY VARY AMONG  $\mu$ Module PRODUCTS. REVIEW EACH PACKAGE LAYOUT CAREFULLY

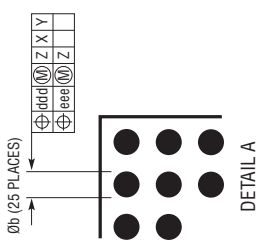

| DIMENSIONS                |      |      |      |                |
|---------------------------|------|------|------|----------------|
| SYMBOL                    | MIN  | NOM  | MAX  | NOTES          |
| A                         | 4.81 | 5.01 | 5.21 |                |
| A1                        | 0.50 | 0.60 | 0.70 | BALL HT        |
| A2                        | 4.31 | 4.41 | 4.51 |                |
| b                         | 0.60 | 0.75 | 0.90 | BALL DIMENSION |
| b1                        | 0.60 | 0.63 | 0.66 | PAD DIMENSION  |
| D                         |      | 6.25 |      |                |
| E                         |      | 6.25 |      |                |
| e                         |      | 1.27 |      |                |
| F                         |      | 5.08 |      |                |
| G                         |      | 5.08 |      |                |
| H1                        | 0.36 | 0.41 | 0.46 | SUBSTRATE THK  |
| H2                        | 3.95 | 4.00 | 4.05 | MOLD CAP HT    |
| aaa                       |      |      | 0.15 |                |
| bbb                       |      |      | 0.10 |                |
| ccc                       |      |      | 0.20 |                |
| ddd                       |      |      | 0.30 |                |
| eee                       |      |      | 0.15 |                |
| TOTAL NUMBER OF BALLS: 25 |      |      |      |                |

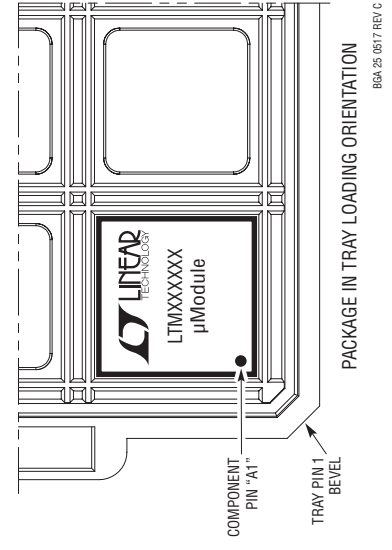



## REVISION HISTORY

| REV | DATE  | DESCRIPTION   | PAGE NUMBER |
|-----|-------|---|-------------|
| A   | 8/13  | Updated FREQ pin description                        | 6           |
|     |       | Updated output overvoltage protection description.  | 8           |
| B   | 2/14  | Add SnPb BGA package option.                        | 1, 2        |
|     |       | Updated RUN threshold.                              | 2           |
| C   | 7/14  | Added TechClip video hyperlink.                     | 1           |
|     |       | Updated Absolute Maximum Ratings section.           | 2           |
|     |       | Updated Pre-Biased Output Start-Up section.         | 13          |
| D   | 7/17  | RUN Abs Max Voltage Changed from $SV_{IN}$ to 15V.  | 2           |
| E   | 11/22 | Changed master to main and slave to subordinate.    | All         |
|     |       | RUN Abs Max Voltage Changed from $15V_{IN}$ to 15V. | 2           |
|     |       | Changed Lead to Pin in the Pin Configuration.       | 2           |
|     |       | Added ink marking statement to package photos.      | 26          |

## PACKAGE PHOTOS Part marking is either ink mark or laser mark

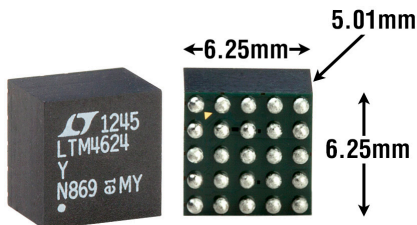

## DESIGN RESOURCES

| SUBJECT  | DESCRIPTION   |
|--|---|
| <a href="#">µModule Design and Manufacturing Resources</a> | <p>Design:</p> <ul style="list-style-type: none"> <li>• Selector Guides</li> <li>• Demo Boards and Gerber Files</li> <li>• Free Simulation Tools</li> </ul> <p>Manufacturing:</p> <ul style="list-style-type: none"> <li>• Quick Start Guide</li> <li>• PCB Design, Assembly and Manufacturing Guidelines</li> <li>• Package and Board Level Reliability</li> </ul> |
| <a href="#">µModule Regulator Products Search</a>          | <ol style="list-style-type: none"> <li>1. Sort table of products by parameters and download the result as a spread sheet.</li> <li>2. Search using the Quick Power Search parametric table.</li> </ol>  |
| <a href="#">Digital Power System Management</a>            | Analog Devices' family of digital power supply management ICs are highly integrated solutions that offer essential functions, including power supply monitoring, supervision, margining and sequencing, and feature EEPROM for storing user configurations and fault logging.   |

## RELATED PARTS

| PART NUMBER              | DESCRIPTION  | COMMENTS   |
|--------------------------|--|--|
| <a href="#">LTM4619</a>  | Dual 26V, 4A Step-Down µModule Regulator   | $4.5V \leq V_{IN} \leq 26.5V$ , $0.8V \leq V_{OUT} \leq 5V$ , PLL Input, $V_{OUT}$ Tracking, PGOOD, 15mm × 15mm × 2.82mm LGA   |
| <a href="#">LTM4618</a>  | 26V, 6A Step-Down µModule Regulator  | $4.5V \leq V_{IN} \leq 26.5V$ , $0.8V \leq V_{OUT} \leq 5V$ , PLL Input, $V_{OUT}$ Tracking, 9mm × 15mm × 4.32mm LGA   |
| <a href="#">LTM4628</a>  | Dual 26V, 8A Step-Down µModule Regulator   | $4.5V \leq V_{IN} \leq 26.5V$ , $0.6V \leq V_{OUT} \leq 5.5V$ , Remote Sense Amplifier, Internal Temperature Sensing Output, 15mm × 15mm × 4.32mm LGA                                  |
| <a href="#">LTM4614</a>  | Dual 5V, 4A µModule Regulator  | $2.375V \leq V_{IN} \leq 5.5V$ , $0.8V \leq V_{OUT} \leq 5V$ , 15mm × 15mm × 2.82mm LGA  |
| <a href="#">LTM4608A</a> | 5V, 8A Step-Down µModule Regulator with Tracking, Margining and Frequency Synchronization      | $2.7V \leq V_{IN} \leq 5.5V$ , $0.6V \leq V_{OUT} \leq 5V$ , PLL input, Clock Output, $V_{OUT}$ Tracking and Margining, PGOOD, 9mm × 15mm × 2.82mm LGA                                 |
| <a href="#">LTM4616</a>  | Dual 5V, 8A Step-Down µModule Regulator with Tracking, Margining and Frequency Synchronization | $2.7V \leq V_{IN} \leq 5.5V$ , $0.6V \leq V_{OUT} \leq 5V$ , PLL input, Clock Output, $V_{OUT}$ Tracking and Margining, PGOOD, 15mm × 15mm × 2.82mm LGA                                |
| <a href="#">LTM8045</a>  | Inverting or SEPIC µModule DC/DC Converter with Up to 700mA Output Current                     | $2.8V \leq V_{IN} \leq 18V$ , $\pm 2.5V \leq V_{OUT} \leq \pm 15V$ , Synchronizable, No Derating or Logic-Level Shift for Control Inputs when Inverting, 6.25mm × 11.25mm × 4.92mm BGA |
| <a href="#">LTC®2978</a> | Octal Digital Power Supply Manager with EEPROM   | I <sup>2</sup> C/PMBus Interface, Configuration EEPROM, Fault Logging, 16-Bit ADC with ±0.25% TUE, 3.3V to 15V Operation   |
| <a href="#">LTC2974</a>  | Quad Digital Power Supply Manager with EEPROM  | I <sup>2</sup> C/PMBus Interface, Configuration EEPROM, Fault Logging, per Channel Voltage, Current and Temperature Measurements   |

# Mouser Electronics

Authorized Distributor

Click to View Pricing, Inventory, Delivery & Lifecycle Information:

[Analog Devices Inc.:](#)

[LTM4624IY#PBF](#) [LTM4624IY](#) [LTM4624EY#PBF](#) [DC1889A](#)