

Inductors for power circuits

Wound ferrite

HPL series(for automotive)



AEC-Q200

## HPL8012060F1 type



## FEATURES

- Achieved high-reliability inductors without joints
- Adoption of ferrites made of LowLoss material and low-RDC by frame forming
- Magnetic flux cancellation realizes low EMI
- Operating temperature range: -55 to +155°C (including self-temperature rise)
- Compliant with AEC-Q200

## APPLICATION

- ADAS - Level5 For CPU/GPU power line

## PART NUMBER CONSTRUCTION

<b>HPL</b>	<b>8012060</b>	<b>F1</b>	<b>R22</b>	<b>M</b>	<b>RD3P</b>
Series name	LxWxH dimensions 8.0x12.0x6.0 mm	Internal code	Inductance (nH)	Inductance tolerance	Internal code

## CHARACTERISTICS SPECIFICATION TABLE

L	Measuring frequency	DC resistance		Rated current*				Part No.		
		(nH) Tolerance	(kHz)	(mΩ)max.	(mΩ)typ.	Isat 1	Isat 2		Itemp	
				(A)25deg.C	(A)125deg.C	(A)25deg.C	(A)125deg.C	(A)typ.		
220	±20%	100	0.55	0.50	75.0	60.0	78.0	62.5	45.0	<a href="#">HPL8012060F1R22MRD3P</a>
330	±20%	100	0.55	0.50	47.0	38.0	49.0	39.5	45.0	<a href="#">HPL8012060F1R33MRD3P</a>

\* Rated current: smaller value of either Isat or Itemp.

Isat 1: When based on the inductance change rate (20% below the initial value)

Isat 2: When based on the inductance change rate (30% below the initial value)

Itemp: When based on the temperature increase (temperature increase of 40°C by self heating)

Measurement equipment

Measurement item	Product No.	Manufacturer
L	4294A	Keysight Technologies
DC resistance	3541	HIOKI
Rated current Isat	3260B	Wayne Kerr Electronics

\* Equivalent measurement equipment may be used.

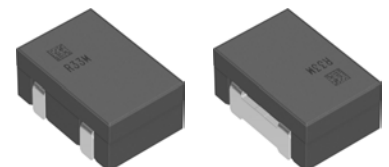

# HPL8012060F1 type

## L FREQUENCY CHARACTERISTICS

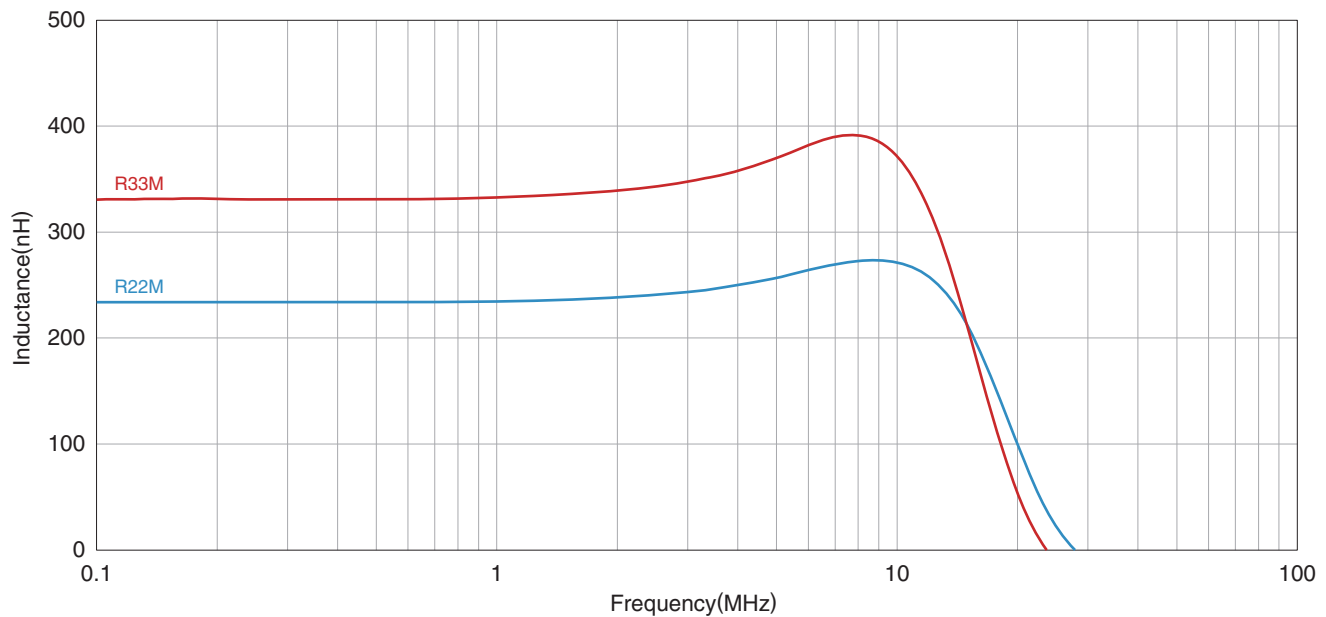

Measurement equipment

Product No.	Manufacturer
4294A	Keysight Technologies

\* Equivalent measurement equipment may be used.

## L VS. DC BIAS CHARACTERISTICS

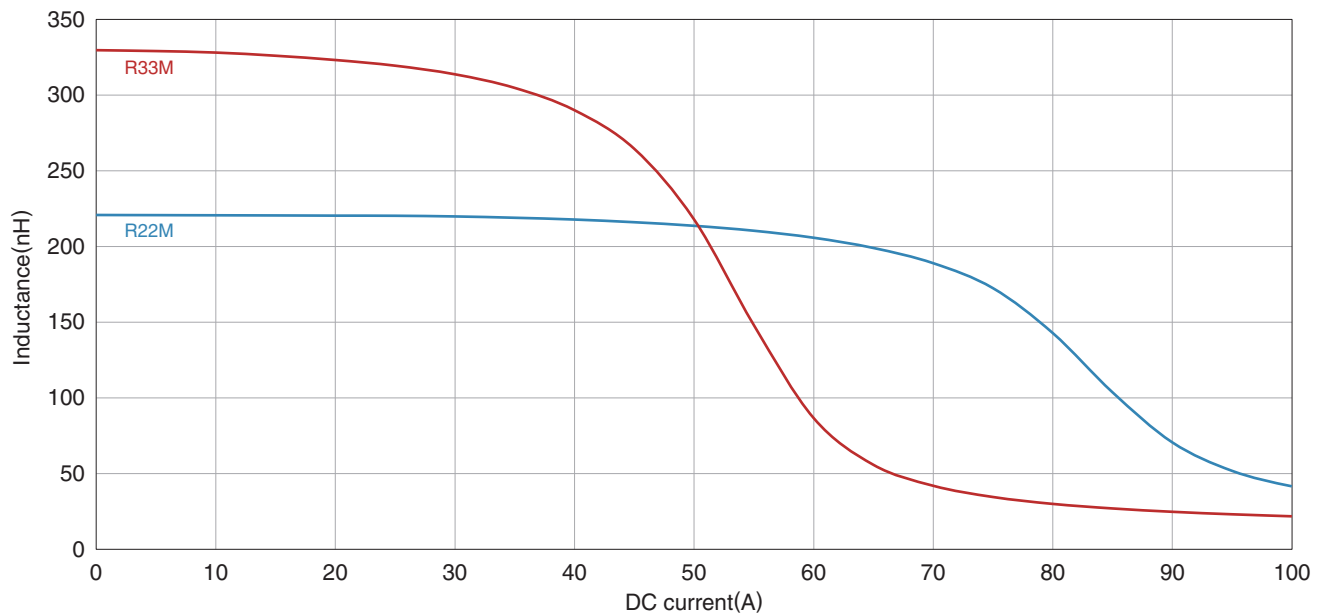

Measurement equipment

Product No.	Manufacturer
3260B	Wayne Kerr Electronics

\* Equivalent measurement equipment may be used.

# HPL8012060F1 type

## ■ SHAPE & DIMENSIONS

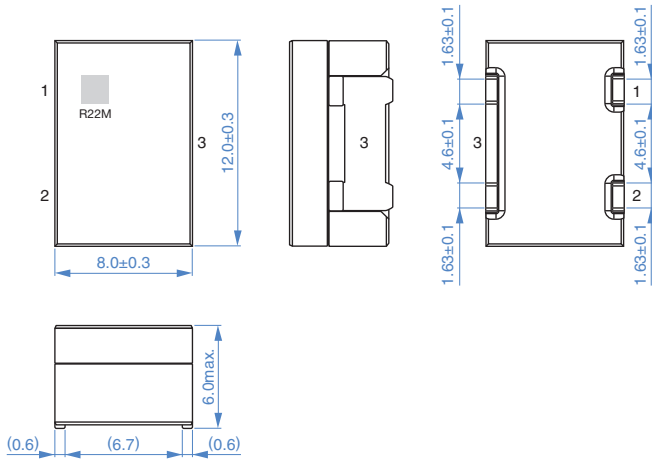

## ■ PACKAGING STYLE

### □ REEL DIMENSIONS

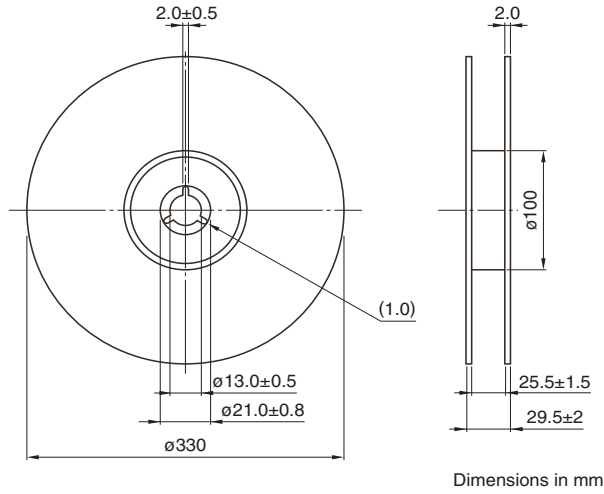

## ■ RECOMMENDED LAND PATTERN

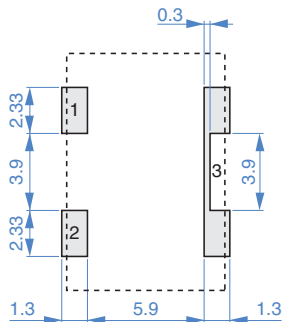

### □ TAPE DIMENSIONS

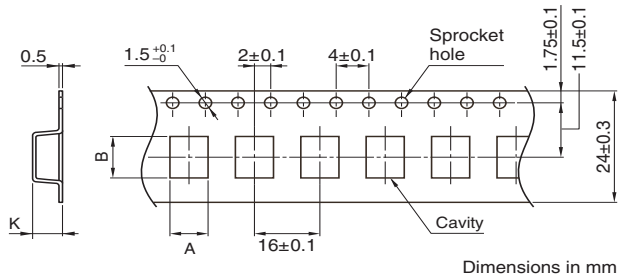

Type	A	B	K
HPL8012060F1	(8.5)	(12.5)	(6.3)

### □ PACKAGE QUANTITY

Package quantity	500 pcs/reel
------------------	--------------

## ■ RECOMMENDED REFLOW PROFILE

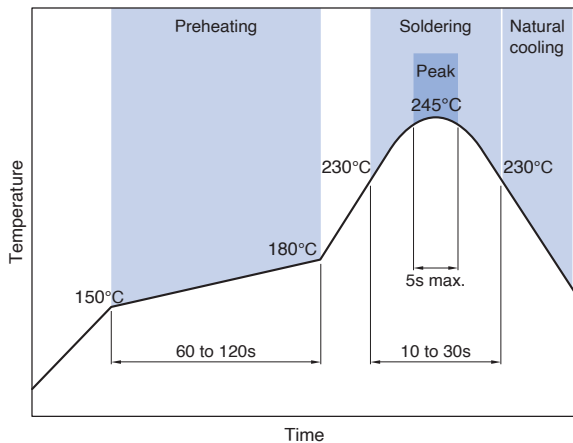

## ■ TEMPERATURE RANGE, INDIVIDUAL WEIGHT

Operating temperature range *	Storage temperature range **	Individual weight
-55 to +155 °C	-55 to +155 °C	2.6 g

\* Operating temperature range includes self-temperature rise.

\*\* The storage temperature range is for after the assembly.

## REMINDERS FOR USING THESE PRODUCTS

Before using these products, be sure to request the delivery specifications.

### SAFETY REMINDERS

Please pay sufficient attention to the warnings for safe designing when using this products

### REMINDERS

- The storage period is within 12 months. Be sure to follow the storage conditions (temperature: 5 to 40°C, humidity: 10 to 75% RH or less).  
If the storage period elapses, the soldering of the terminal electrodes may deteriorate.
- Soldering corrections after mounting should be within the range of the conditions determined in the specifications.  
If overheated, a short circuit, performance deterioration, or lifespan shortening may occur.
- Do not use products that have received any excessive mechanical shock such as by being dropped.
- When embedding a printed circuit board where a chip is mounted to a set, be sure that residual stress is not given to the chip due to the overall distortion of the printed circuit board and partial distortion such as at screw tightening portions.
- Self heating (temperature increase) occurs when the power is turned ON, so the tolerance should be sufficient for the set thermal design.
- Do not expose the products to magnets or magnetic fields.
- The performance of the product may deteriorate if coating materials are used, thus please assess the situation beforehand by taking this factor into consideration.
- Do not use for a purpose outside of the contents regulated in the delivery specifications.

- The products listed on this catalog are intended for use in general electronic equipment (AV equipment, telecommunications equipment, home appliances, amusement equipment, computer equipment, personal equipment, office equipment, measurement equipment, industrial robots) under a normal operation and use condition.

The products are not designed or warranted to meet the requirements of the applications listed below, whose performance and/or quality require a more stringent level of safety or reliability, or whose failure, malfunction or trouble could cause serious damage to society, person or property.

If you intend to use the products in the applications listed below or if you have special requirements exceeding the range or conditions set forth in the each catalog, please contact us.

- |   |  |
|---|--|
| (1) Aerospace/aviation equipment                            | (7) Transportation control equipment   |
| (2) Transportation equipment (electric trains, ships, etc.) | (8) Public information-processing equipment                                  |
| (3) Medical equipment                                       | (9) Military equipment   |
| (4) Power-generation control equipment                      | (10) Electric heating apparatus, burning equipment                           |
| (5) Atomic energy-related equipment                         | (11) Disaster prevention/crime prevention equipment                          |
| (6) Seabed equipment  | (12) Safety equipment  |
|   | (13) Other applications that are not considered general-purpose applications |

When designing your equipment even for general-purpose applications, you are kindly requested to take into consideration securing protection circuit/device or providing backup circuits in your equipment.