

300W, 9 to 53V Input Non-Isolated Ruggedized DC-DC Buck-Boost Converters

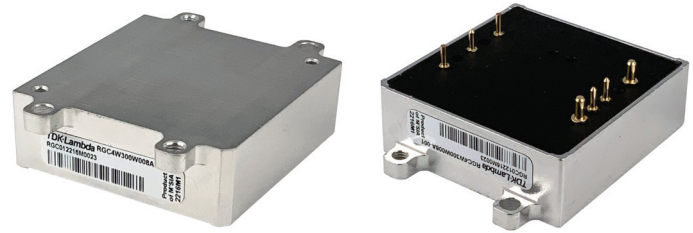

The rugged RGC non-isolated DC-DC step-up and step-down converters are encapsulated in a five-sided aluminum case and rated for up to 115°C operation. The modules have the industry standard 1/16th brick pin-out, are qualified to MIL-STD-810G (shock and vibration) and designed for fan-less, conduction cooled applications. The series accepts a wide input range to support multiple DC bus and battery voltages. Standard features include remote on/off, remote sense and output trim while a full feature adds power good, frequency synchronization and output current monitoring, making the modules a truly versatile board mount power solution. The wide output adjustment range allows one model to be used in multiple positions, assisting inventory and part number reduction.

Features	Benefits
• Up to 300W in a 1/16th Brick-Pin-Out	• High Power Density, Less Board Area Needed
• Encapsulated in a 5-sided Aluminum case	• Improves EMI
• 115°C maximum case temperature	• Rugged deployment in harsh environment with high shock & vibration exposure
• Efficiency - Up to 97%	• Longer Battery Life / Low Power Consumed
• Wide Output Adjustment from 5 up to 48V	• One Part Supports Multiple System Voltages
• Wide Input Range from 9 to 53V	• Can Operate from Different DC Input Source Voltages
• Buck-Boost - maintains output regulation even when input varies	• Extends run times on battery-powered equipment

Model Selector						
Model	Input Voltage (V)	Output Voltage (V)	Max Current (A)	Max Power (W)	Negative Logic On/Off	Feature Set
RGC4W300W008A-001	9 - 53	9.6 - 48	8	300	Yes	Standard
RGC4W300W008A-003	9 - 53	9.6 - 48	8	300	Yes	Full
RGC4W300W012A-001	9 - 53	5.0 - 28	12.5	300	Yes	Standard
RGC4W300W012A-003	9 - 53	5.0 - 28	12.5	300	Yes	Full

Contact factory for other upcoming part number suffix options.

Related Products		
Type	Part Number(s)	Size (mm) / Description
Ruggedized DC-DC Buck Converter	RGA	250W, Input 9-40V and Output 3.3-24V or, 9-53V Input and 3.3V up to 40V Output
DC-DC Buck-Boost Converter	i7C	300W, Input 9-53V or 9-36V, Output 9.6-48V 8A, 5-28V 12.5A or 8-24V 20A
DC-DC Buck Converter	i7A	500-750W, Input 18-60V or 18-32V, Output 3.3-24V 33A or 3.3-18V 45A
DC-DC Buck Converter	i6A4W	250W, Input 9 -53V, Output 3.3-40V 10A or 3.3-15V 20A
Isolated DC-DC Converter	GQA	120W Industrial, Input 9-36V, Isolated Quarter Brick
Non-Isolated DC-DC Converter	iBH	80W/20A, 3.5-14Vin, 0.7 - 5.5Vout, DOSA Compatible
Non-Isolated DC-DC Converter	iCH	85W/12A, 4.5-14Vin, 0.7 - 8.5Vout, DOSA Compatible
Input Filter	iDQ	75V / 10A Filter
Evaluation Board	i7X-C01-EVK-S0	Evaluation board with no module. Order required RGC part number separately.

Specifications			
Model		RGC4W300W008A	RGC4W300W012A
Input			
Input Voltage Range	Vdc	9 - 53	
Input Current (max)	A	25	
Standby Input Current	mA	0.25	
No Load Input Current	mA	5	
Turn-ON Input Voltage	Vdc	9.5	
Turn-OFF Input Voltage	Vdc	8.5	
Efficiency (typ)	%	93 - 97%	91 - 96%
Safety Certifications and Markings	-	CE, UKCA Mark	
Output			
Output Voltage Initial Setpoint	%	±2.5	±2.5
Output Voltage Tolerance	%	±4.0	±4.0
Line Regulation	%	0.8	0.8
Load Regulation	%	0.5	0.8
Ripple & Noise ⁽²⁾	(step-down)	60	100
	(step-up)	300	350
External Load Capacitance	µF	330 - 3000	
Switching Frequency	kHz	250	
Overcurrent Protection Threshold (typ)	A	15	17
Overtemperature Protection	°C	130 case, shutdown - autorecovery	
Output Voltage Adjustment Range		See full specification for output trim equation.	
Remote Sense		(+ Sense, compensating up to 5% of output voltage	
Remove On/Off		Negative Logic	
Frequency Synchronization		See full specifications	
Current Monitoring (I _{mon})		See full specifications	
Environmental			
Operating Temperature (T _{case})	°C	-40 to 115	
Storage Temperature	°C	-55 to 125	
Humidity (non condensing)	%RH	10 - 95	
Altitude ⁽³⁾	m	2000	
Cooling	-	Conduction Cooling	
Shock	-	MIL-STD-810G 516.6 Procedure I & IV	
Vibration		MIL-STD-810G 514.6 Procedure I, Cat 10	
Thermal Cycling Test (TCT)		Qualified to 700 cycles / -40 to 125°C, 60°C/minute ramp, 30minute dwell time	
Other			
Weight (max)	g	68.1	
Size (LxWxH)	mm	38.1 x 49.5 x 13.0	
		38.1 x 39.4 x 13.0 (Mounting tab excluded)	
Size (LxWxH)	Inches	1.50 x 1.95 x 0.51	
		1.50 x 1.55 x 0.51 (Mounting tab excluded)	
MTBF - Telcordia SR-332 (100% Load, 40°C)	MHrs	> 10	
Warranty	yrs	3	

Notes

- (1) See website for detailed product [specifications](#).
(2) Measured with one 330 µF electrolytic and one 22 µF ceramic capacitors, BW = 20MHz.
(3) Contact Technical Support for operation at higher altitudes.

Operating Range (RGC4W300W008A-001)

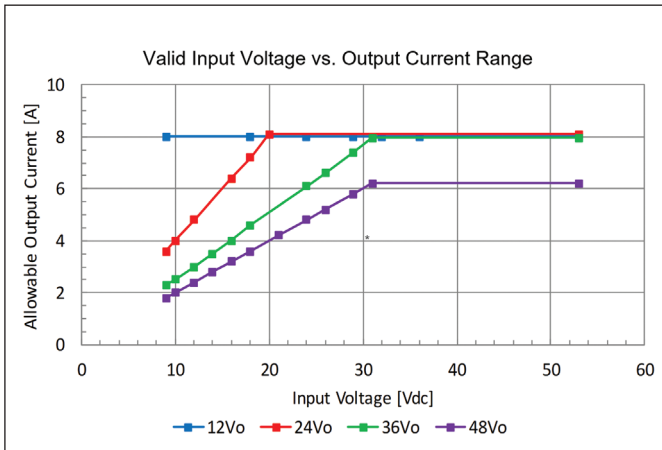

Operating Range (RGC4W300W012A-001)

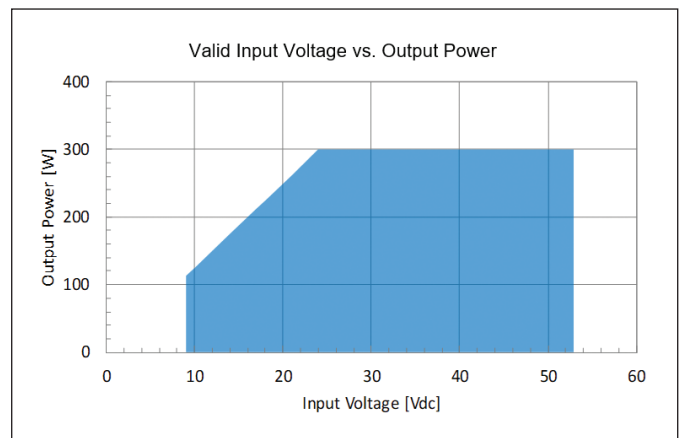
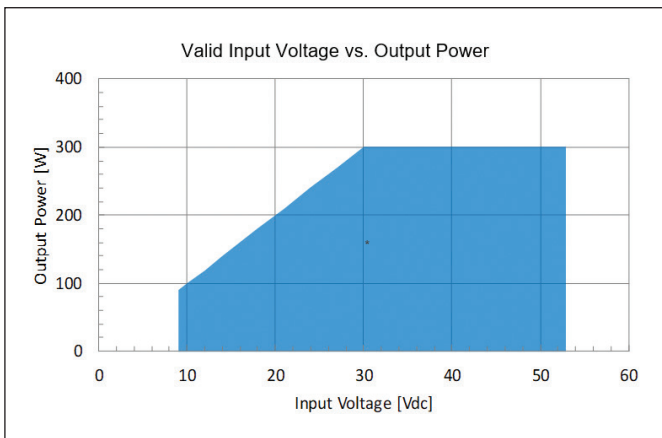
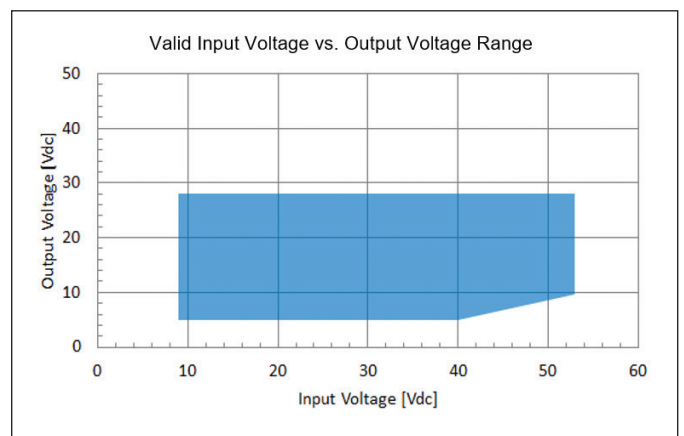
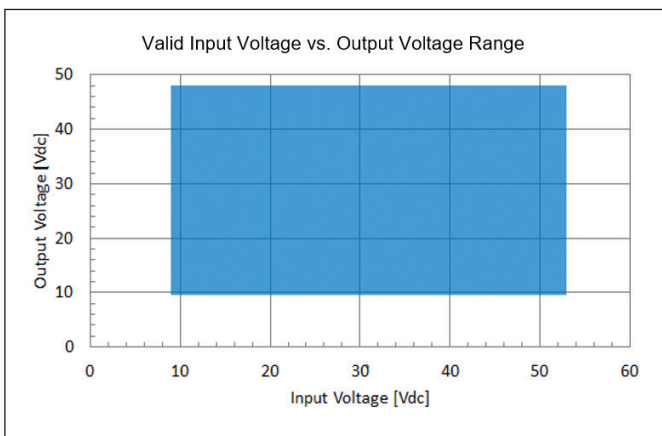
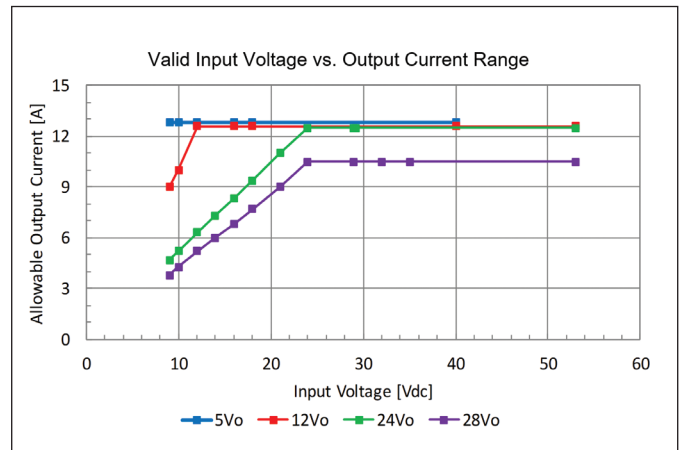

Typical Thermal Derating (RGC4W300W008A-001)

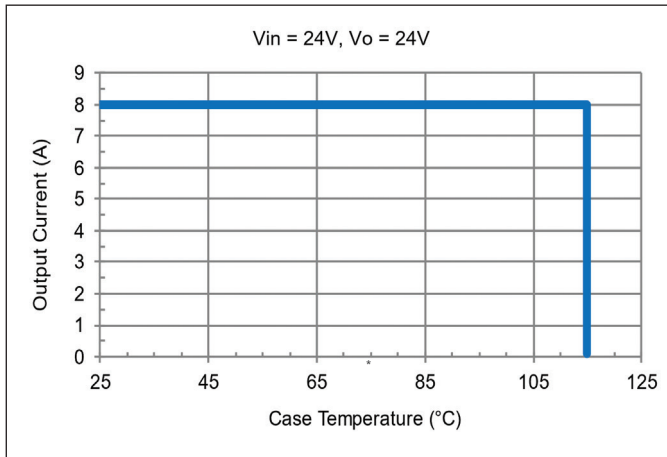

Typical Thermal Derating (RGC4W300W012A-001)

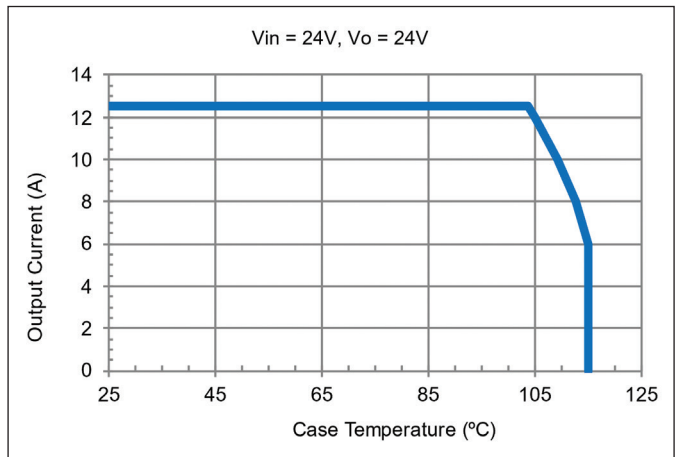

Typical Application Circuit

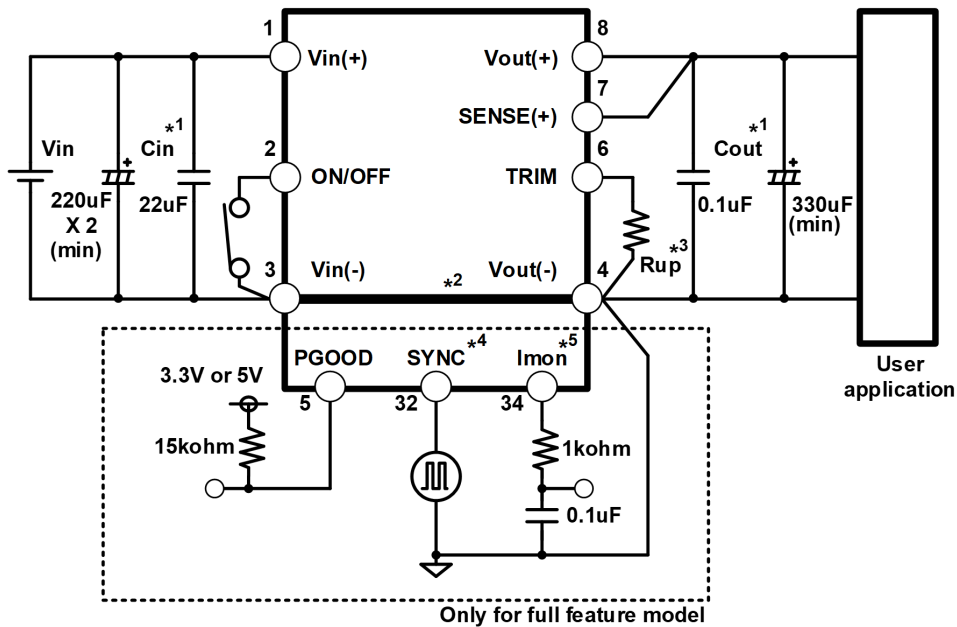

Recommendation

1. Cin/Cout MLCC should be connected to the RGC module as close as possible in order to reject high frequency noise.
2. Connect Vin(-) and Vout(-) to copper ground plane underneath the RGC module.
3. TRIM resistor "Rup" should be connected to the RGC module as close as possible.
4. SYNC must be connected to GND when not in use.
5. External R-C filter should be present when using Current Monitor.

Mechanical Specification

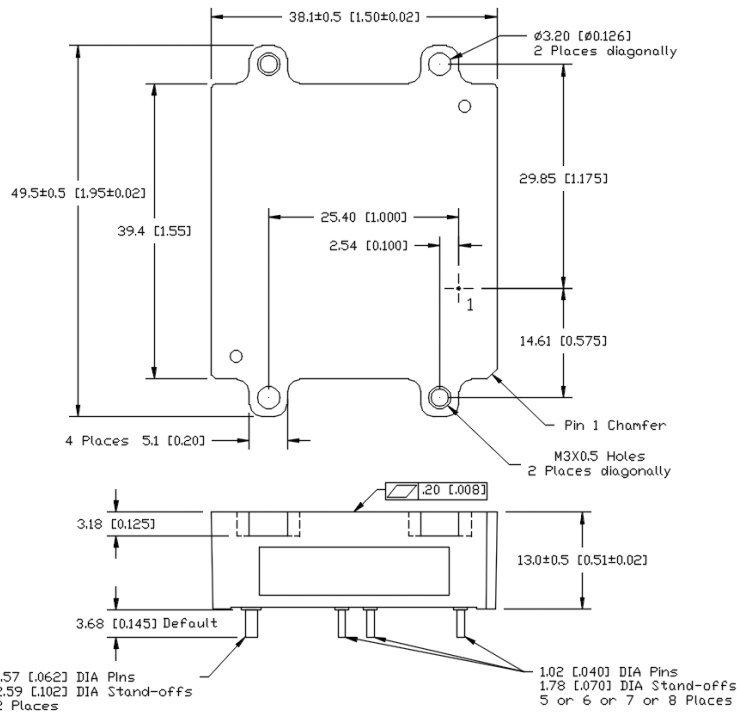

Note: Case is not connected to ground (floating).

Recommended PCB Hole Pattern

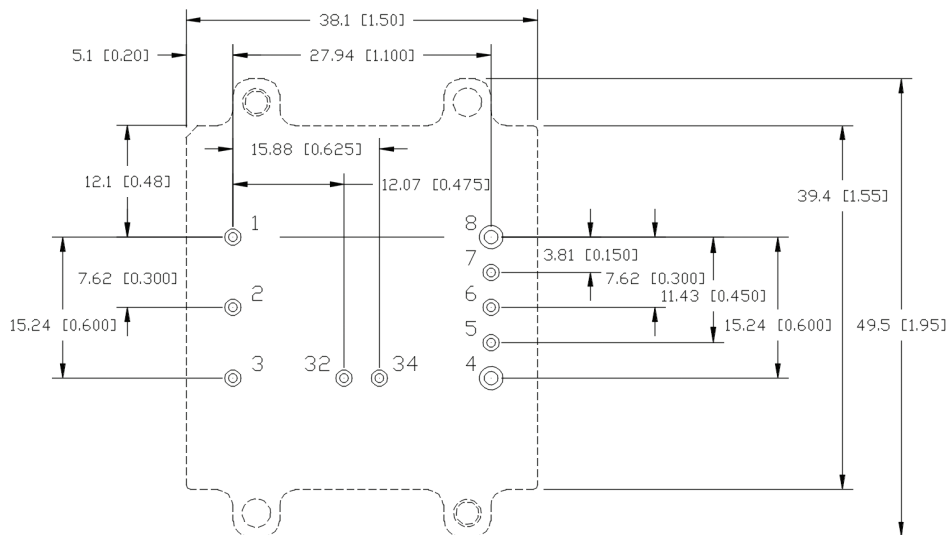

Pinout

PIN	Function	PIN	Function
1	VIN(+)	6	TRIM
2	ON / OFF	7	SENSE (+)
3	VIN (-) / GND	8	VOUT (+)
4	VOUT (-) / GND	32	Sync (Option)
5	PWR GOOD (Option)	34	Current Monitor / Imon (Option)

Pin base material is brass or copper with gold over nickel plating.



TDK-Lambda France SAS

Tel: +33 1 60 12 71 65
 ttf.fr.powersolutions@tdk.com
 www.emea.lambda.tdk.com/fr



Italy Sales Office

Tel: +39 02 61 29 38 63
 ttf.it.powersolutions@tdk.com
 www.emea.lambda.tdk.com/it



Netherlands

ttf.nl.powersolutions@tdk.com
 www.emea.lambda.tdk.com/nl



TDK-Lambda Germany GmbH

Tel: +49 7841 666 0
 tlg.powersolutions@tdk.com
 www.emea.lambda.tdk.com/de



Austria Sales Office

Tel: +43 2256 655 84
 tlg.at.powersolutions@tdk.com
 www.emea.lambda.tdk.com/at



Switzerland Sales Office

Tel: +41 44 850 53 53
 tlg.ch.powersolutions@tdk.com
 www.emea.lambda.tdk.com/ch



Nordic Sales Office

Tel: +45 8853 8086
 tlg.dk.powersolutions@tdk.com
 www.emea.lambda.tdk.com/dk



TDK-Lambda UK Ltd.

Tel: +44 (0) 12 71 85 66 66
 tlu.powersolutions@tdk.com
 www.emea.lambda.tdk.com/uk



TDK-Lambda Ltd.

Tel: +9 723 902 4333
 tti.powersolutions@tdk.com
 www.emea.lambda.tdk.com/il-en



TDK-Lambda Americas

Tel: +1 800-LAMBDA-4 or 1-800-526-2324
 tia.powersolutions@tdk.com
 www.us.lambda.tdk.com



TDK Electronics do Brasil Ltda

Tel: +55 11 3289-9599
 sales.br@tdk-electronics.tdk.com
 www.tdk-electronics.tdk.com/en



TDK-Lambda Corporation

Tel: +81-3-6778-1113
 www.jp.lambda.tdk.com



TDK-Lambda (China) Electronics Co. Ltd.

Tel: +86 21 6485-0777
 tlc.powersolutions@tdk.com
 www.lambda.tdk.com.cn



TDK-Lambda Singapore Pte Ltd.

Tel: +65 6251 7211
 tis.marketing@tdk.com
 www.sg.lambda.tdk.com



TDK India Private Limited, Power Supply Division

Tel: +91 80 4039-0660
 mathew.philip@tdk.com
 www.sg.lambda.tdk.com

