

Features

- 4kVDC/1sec basic grade isolation
- Industry standard 5W 1"x1" package
- Feedback regulated output
- Derates to 110°C ambient temperature
- Wide 4:1 input
- ON/OFF control pin, UVLO, SCP
- 0% minimum load

Regulated Converters

REC5K-AW

5 Watt
1" x 1"
Single Output



UL62368-1 certified
C22.2 No. 62368-1-1 certified
IEC/EN62368-1 certified
CB Report

Description

This series offers basic isolation of 4kVDC/1sec making it ideal for both industrial, medical, and other sophisticated high end applications. The compact 1"x1" non-conductive plastic package ensures high power density without compromising performance, operating with derating up to 110°C. Short circuit protection, undervoltage lockout, and remote on/off control is standard, and the converter is certified according to UL/IEC/EN62368-1.

Selection Guide

Part Number	Input Voltage Range [VDC]	nom. Output Voltage [VDC]	Output Current [mA]	Efficiency typ. (1) [%]	max. Capacitive Load (2) [µF]
REC5K-2405SAW/H4	9 - 36	5	1000	77	3000

Notes:

Note1: Efficiency is tested at nominal input and full load at +25°C ambient
 Note2: Max Cap Load is tested at nominal input and full resistive load

Model Numbering

REC5K-24 05 S AW/H4

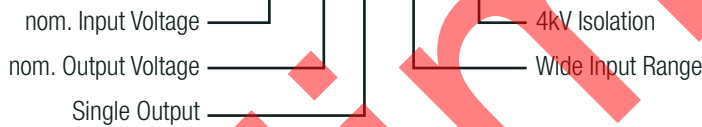

Specifications (measured @ Ta= 25°C, nom. Vin, full load and after warm-up unless otherwise stated)

BASIC CHARACTERISTICS				
Parameter	Condition	Min.	Typ.	Max.
Input Voltage Range	nom. V_{IN} = 24VDC	9VDC		36VDC
Under Voltage Lockout (UVLO)	DC-DC ON	8.2VDC		8.8VDC
	DC-DC OFF	5.4VDC		6.0VDC
Input Current		240mA		270mA
Quiescent Current				20mA
Minimum Load		0%		
Startup time				50ms
ON/OFF CTRL	DC-DC ON	Open or $V_{CTRL} > 1.5VDC$		
	DC-DC OFF	Short to $-V_{IN}$ or $< 1.5VDC$		
Input Current on CTRL Pin	DC-DC ON			1mA
Standby Current			3mA	6mA
Internal Operating Frequency				400kHz
Output Ripple and Noise (3)	20MHz BW			240mVp-p

Notes:
 Note3: Measurements are made with a 0.1µF MLCC across output (low ESR)

continued on next page

Specifications (measured @ Ta= 25°C, nom. Vin, full load and after warm-up unless otherwise stated)

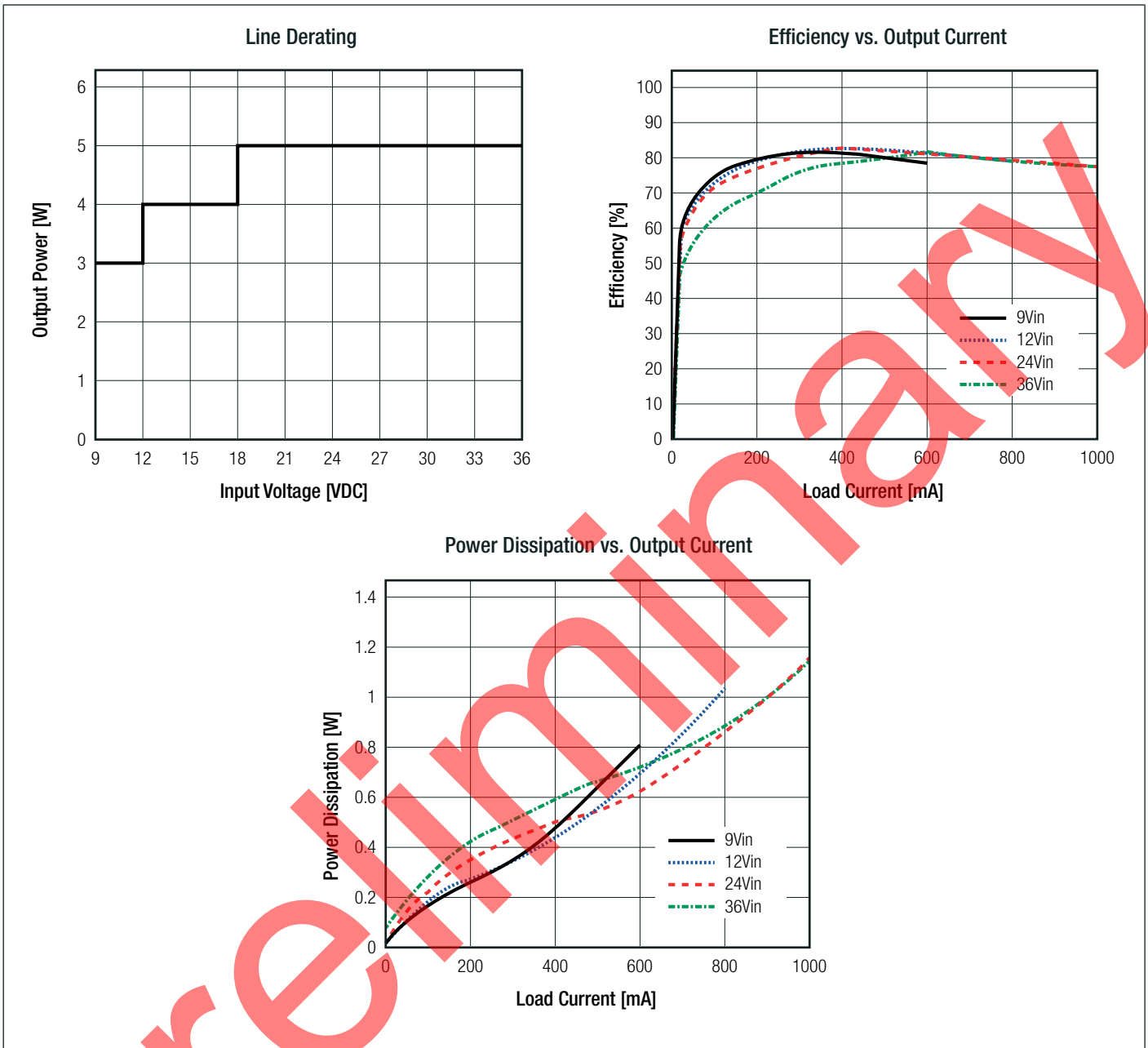

REGULATIONS		
Parameter	Condition	Value
Output Accuracy		±2.5% typ.
Line Regulation	low line to high line, full load	±2.0% max.
Load Regulation ⁽⁴⁾	10% to 100% load	2.0% max.

Notes:

Note4: Operation below 10% load will not harm the converter, but specifications may not be met

continued on next page

Specifications (measured @ Ta= 25°C, nom. Vin, full load and after warm-up unless otherwise stated)

Deviation vs. Output Current

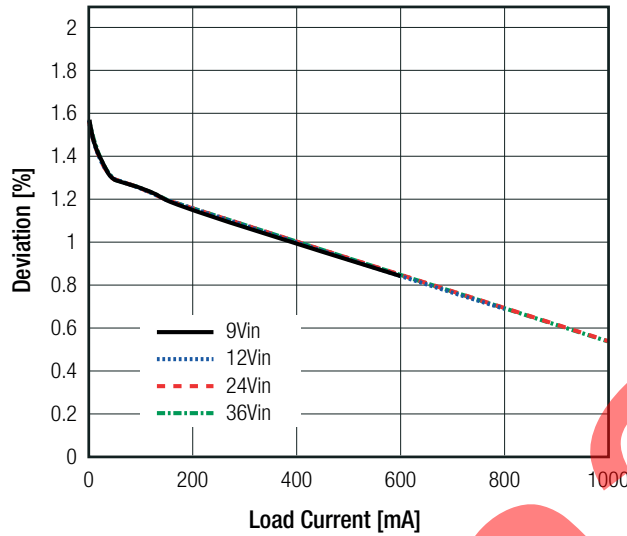

PROTECTIONS

Parameter	Type	Value
Short Circuit Protection (SCP)		hiccup mode, auto recovery
Short Circuit Input Current	nom. $V_{IN} = 24VDC$	120mA max.
Isolation Voltage ⁽⁵⁾	1 second	4kVDC
	1 minute	2kVAC/50Hz
Isolation Resistance	I/P to O/P, $V_{ISO} = 500VDC$	1GΩ min.
Isolation Capacitance	I/P to O/P, 100kHz/0.1V	50pF max.
Insulation Grade	according to 62368-1	basic

Notes:

Note5: For repeat Hi-Pot testing, reduce the time and/or the test voltage

Note6: Refer to local safety regulations if input over-current protections is also required. Recommended fuse: slow blow type

ENVIRONMENTAL

Parameter	Condition		Value
Operating Temperature Range	with derating	refer to "Derating Graph"	-40°C to +110°C
Maximum Case Temperature			+125°C
Operating Altitude			5000m
Operating Humidity	non-condensing		95% RH max.
Pollution Degree			PD2
MTBF	according to MIL-HDBK-217F, G.B.	$T_{AMB} = +25^{\circ}C$	1408 x 10 ³ hours
		$T_{AMB} = +65^{\circ}C$	684 x 10 ³ hours

continued on next page

Specifications (measured @ $T_a = 25^\circ\text{C}$, nom. V_{in} , full load and after warm-up unless otherwise stated)

Derating Graph

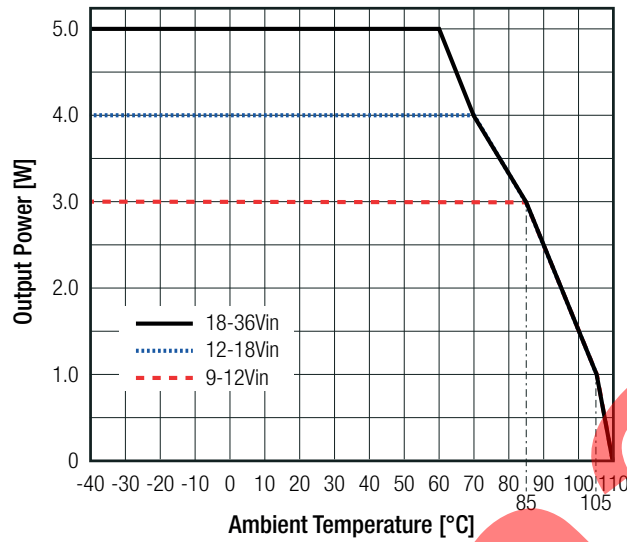

SAFETY AND CERTIFICATIONS

Certificate Type (Safety)	Report / File Number	Standard
Audio/Video, information and communication technology equipment - Part1: Safety requirements 3rd Edition	E491408-A6023-UL	UL62368-1:2019 3rd Edition
		CAN/CSA-C22.2 No. 62368-1-19 3rd Edition
Audio/Video, information and communication technology equipment - Part1: Safety requirements 3rd Edition (CB Scheme)	085-220181201-000	IEC62368-1:2018 3rd Edition
		EN IEC 62368-1:2020+A11:2020
RoHS2		RoHS-2011/65/EU + AM-2015/863
EMC Compliance	Condition	Standard / Criterion
Electromagnetic Compatibility of Multimedia Equipment - Emission Requirements	with external filter	EN55032, Class B

EMC Filtering Suggestions according to EN55032

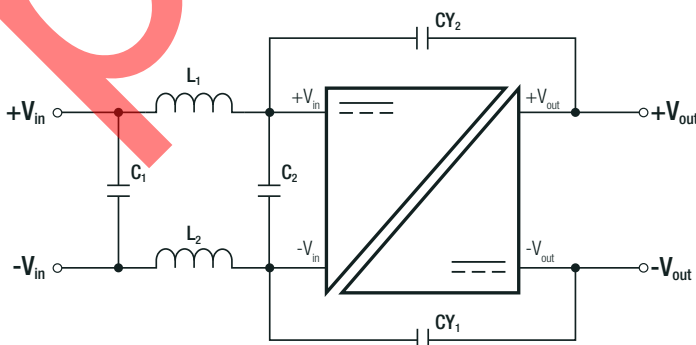

Component List Class B

L1/L2	C1/C2	CY1/CY2
RLS-226	22 μF	2.2nF

Specifications (measured @ Ta= 25°C, nom. Vin, full load and after warm-up unless otherwise stated)

DIMENSION AND PHYSICAL CHARACTERISTICS

Parameter	Type	Value
Material	case	black plastic, (UL94 V-0)
	potting	PU, (UL94 V-0)
	PCB	FR4, (UL94 V-0)
Dimension (LxWxH)		25.4 x 25.4 x 10.0mm
Weight		12g typ.

Dimension Drawing (mm)

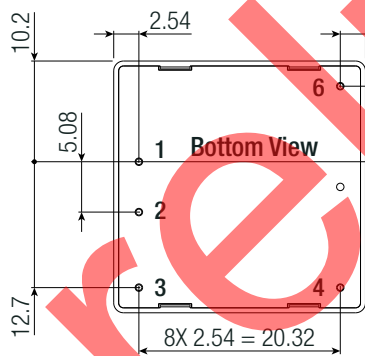
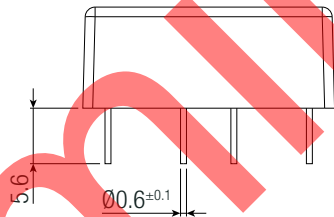
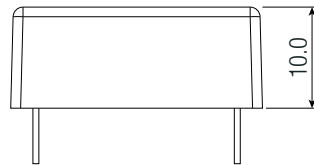
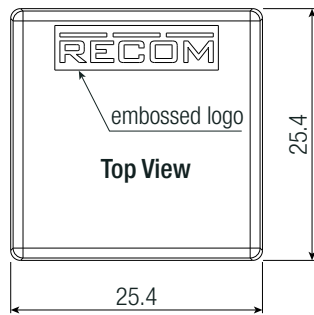

Recommended Footprint Details

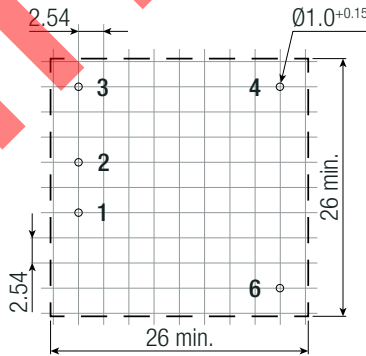

Pinning Information

Pin #	Function
1	+Vin
2	-Vin
3	CTRL
4	-Vout
6	+Vout

NC= No Connection

Tolerance:
xx.x = ±0.5mm
xx.xx = ±0.25mm

PACKAGING INFORMATION

Parameter	Type	Value
Packaging Dimension (LxWxH)	tube	520.0 x 27.5 x 19.3mm
Packaging Quantity		18pcs
Storage Temperature Range		-50°C to +125°C
Storage Humidity	non-condensing	95% RH max.

The product information and specifications may be subject to changes even without prior written notice. The product has been designed for various applications; its suitability lies in the responsibility of each customer. The products are not authorized for use in safety-critical applications without RECOM's explicit written consent. A safety-critical application is an application where a failure may reasonably be expected to endanger or cause loss of life, inflict bodily harm or damage property. The applicant shall indemnify and hold harmless RECOM, its affiliated companies and its representatives against any damage claims in connection with the unauthorized use of RECOM products in such safety-critical applications.

Mouser Electronics

Authorized Distributor

Click to View Pricing, Inventory, Delivery & Lifecycle Information:

[RECOM:](#)

[REC5K-2405SAW/H4](#)