

MC9S08DZ128 Series Data Sheet with Addenda

Rev.2 of the MC9S08DZ128 Series Data Sheet has three parts:

- The revision 2 of the addendum to revision 1 of the data sheet, immediately following this cover page.
- The revision 1 of the addendum to revision 1 of the data sheet, following the revision 2 of the addendum.
- Revision 1 of the data sheet, following the addendum revision 1. The changes described in the addenda have not been implemented in the specified pages.

Addendum Rev.2 to Rev. 1 of the MC9S08DZ128 Series Data Sheet

This addendum identifies changes to Rev. 1 of the MC9S08DZ128 Series Data Sheet. The changes described in this addendum have not been implemented in the specified pages.

1 MCG Control Register 3 Field Descriptions

Location:	Table 8-7, Page 176
------------------	-------------------------------------

The last sentence of bit 4 (DIV32) description should be changed from "Writes to this bit are ignored if PLLS bit is set." to "DIV32 must be cleared when the PLL is selected." The correct description should be:

Field	Description
4 DIV32	Divide-by-32 Enable — Controls an additional divide-by-32 factor to the external reference clock for the FLL when RANGE bit is set. When the RANGE bit is 0, this bit has no effect. DIV32 must be cleared when the PLL is selected. 0 Divide-by-32 is disabled. 1 Divide-by-32 is enabled when RANGE=1.

2 Initializing the MCG

Location:	Section 8.5.1.1, Page 186
------------------	---

The last sentence in the note after step 6 should be removed. The note should be

NOTE

Setting DIV32 (bit 4) in MCGC3 is strongly recommended for FLL external modes when using a high frequency range (RANGE = 1) external reference clock.

3 Example # 1: Moving from FEI to PEE Mode: External Crystal = 8 MHz, Bus Frequency = 16 MHz

Location:	Section 8.5.3.1, Page 189
------------------	---

The first statement in step 2b should be “BLPE/PBE: MCGC3 = 0x48 (%01001000)”, and the second bullet in step 2b should be "DIV32 (bit 4) must be cleared when PLLS is set." The correct content should be:

- a) BLPE: If a transition through BLPE mode is desired, first set LP (bit 3) in MCGC2 to 1.
- b) BLPE/PBE: MCGC3 = 0x48 (%01001000)
 - PLLS (bit 6) set to 1, selects the PLL. At this time, with an RDIV value of %011, the FLL reference divider of 256 is switched to the PLL reference divider of 8 (see [Table 8-3](#)), resulting in a reference frequency of 8 MHz/ 8 = 1 MHz. In BLPE mode, changing the PLLS bit only prepares the MCG for PLL usage in PBE mode
 - DIV32 (bit 4) must be cleared when PLLS is set.
 - VDIV (bits 3-0) set to %1000, or multiply-by-32 because 1 MHz reference * 32= 32MHz. In BLPE mode, the configuration of the VDIV bits does not matter because the PLL is disabled. Changing them only sets up the multiply value for PLL usage in PBE mode

4 Flowchart of FEI to PEE Mode Transition using an 8 MHz crystal

Location:	Section 8.5.3.1, Page 190
------------------	---

The "MCGC3 = \$58" in top right box of flowchart should be "MCGC3 = \$48". The correct figure should be:

Flowchart of FEI to PEE Mode Transition using an 8 MHz crystal

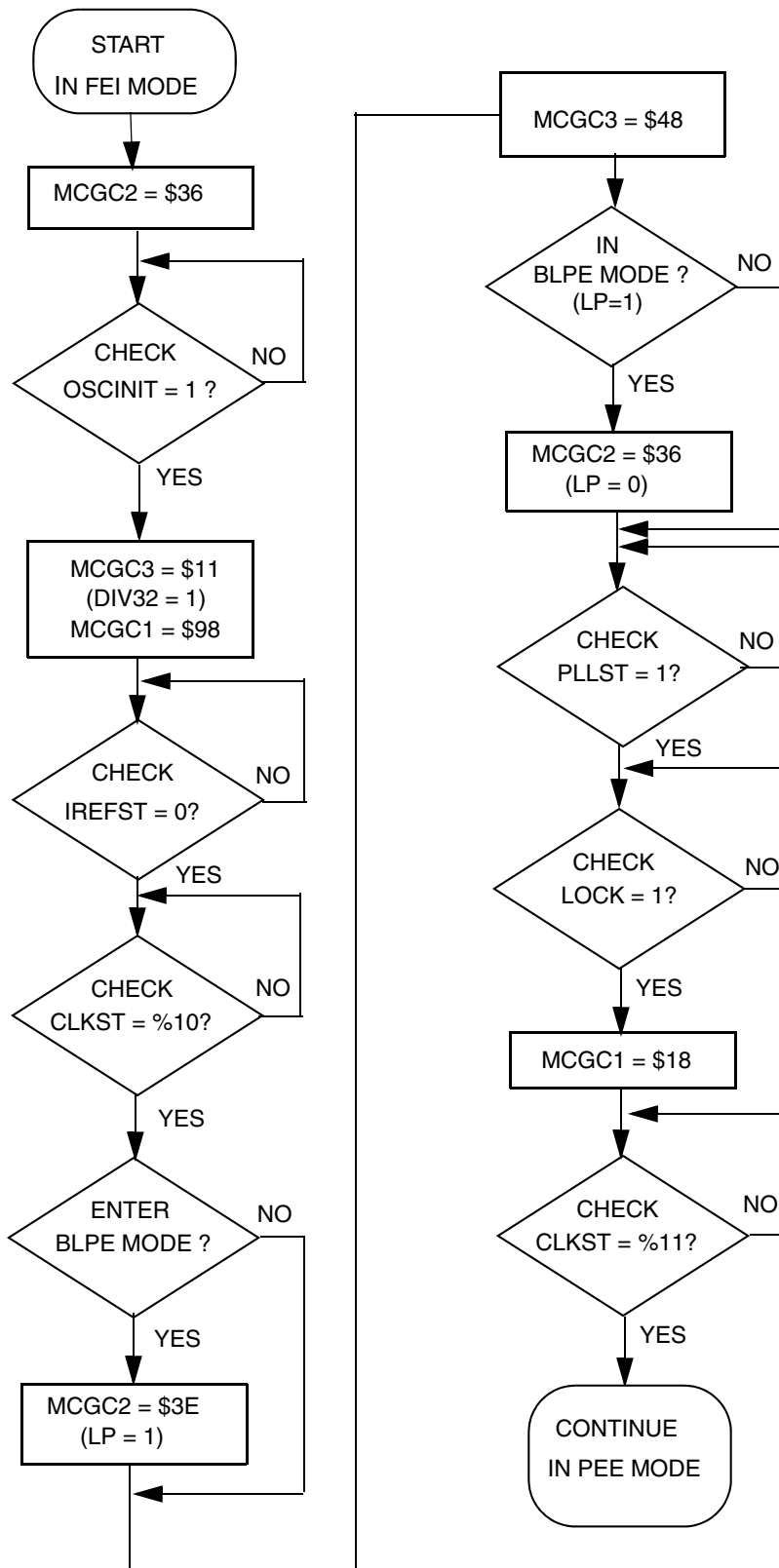

5 DC Characteristics

Location: [Table A-6 Page 424](#)

The minimum value in parameter 24, Bandgap Voltage Reference, from 1.19V to 1.18V. Remove "Temp = 25 °C" from footnote 10. The correct rating and footnote 10 should be:

Num	C	Characteristic	Symbol	Condition	Min	Typ	Max	Unit
24	P	Bandgap Voltage Reference ¹⁰	V_{BG}		1.18	1.20	1.21	V

¹⁰ Factory trimmed at $V_{DD} = 5.0$ V.

6 Oscillator Electrical Specifications

Location: [Table A-11 Page 435](#)

- Update the parameter 1, Oscillator crystal or resonator (EREFS = 1, ERCLKEN = 1), as shown below, to correct the maximum high range oscillator frequencies with respect to the HGO bit setting.
- Replace parameter 6, Square wave input clock frequency (EREFS = 0, ERCLKEN = 1), as shown below to correct the maximum square wave input clock frequency for FEE or FBE modes.
- Replace footnotes 1 and 2 as shown below to correct the typical characterization voltage and add the DIV32 divisor.

Num	C	Rating	Symbol	Min	Typ ¹	Max	Unit
1	C	Oscillator crystal or resonator (EREFS = 1, ERCLKEN = 1)					
		Low range (RANGE = 0)	f_{lo}	32	—	38.4	kHz
		High range (RANGE = 1, HGO = 1) ^{2,3}	f_{hi-hgo}	1	—	16	MHz
		High range (RANGE = 1, HGO = 0) ^{2,3}	f_{hi-lp}	1	—	8	MHz

Num	C	Rating	Symbol	Min	Typ ¹	Max	Unit
6	T	Square wave input clock frequency (EREFS = 0, ERCLKEN = 1)					
		FEE or FBE mode ²	f_{extal}	0.03125	—	16	MHz
		PEE or PBE mode ³		1	—	16	
BLPE mode	0	—		40			

¹ Data in Typical column was characterized at 5.0 V, 25° C or is typical recommended value.

² When MCG is configured for FEE or FBE mode, input clock source must be divisible using RDIV and DIV32 to within the range of 31.25 kHz to 39.0625 kHz.

³ When MCG is configured for PEE or PBE mode, input clock source must be divisible using RDIV to within the range of 1 MHz to 2 MHz.

7 MCG Specifications

Location: [Table A-12 Page 436](#)

The f_{int_ut} in the rating of the f_{dco_t} should be f_{int_t} . The correct rating should be:

Num	C	Rating	Symbol	Min	Typical	Max	Unit	
6	P	DCO output frequency range - trimmed ²	f_{dco_t}	Low range (DRS=0, DMX32=0) $f_{dco_t} = 512 \times f_{int_t}$	16	—	20	MHz
	P			Mid range (DRS=1, DMX32=0) $f_{dco_t} = 1024 \times f_{int_t}$	32	—	40	

Addendum Rev.1 to Rev. 1 of the MC9S08DZ128 Series Data Sheet

This addendum identifies changes to Rev. 1 of the MC9S08DZ128 Series Data Sheet. The changes described in this addendum have not been implemented in the specified pages.

1 Pin Availability by Package Pin-Count

Location: [Table 2-1, Page 34](#)

Pin assignments for rows numbered 9– 15 in table 2-1 required updating. The correct information should be:

Pin Number			<-- Lowest Priority --> Highest			
100	64	48	Port Pin/Interrupt		Alt 1	Alt 2
9	7	4				V _{DD}
10	8	5				V _{SS}
11	9	6	PTG0		EXTAL	
12	10	7	PTG1		XTAL	
13	11	8				RESET
14	—	—	PTJ2	PIJ2	TPM3CH2	
15	—	—	PTJ3	PIJ3	TPM3CH3	

2 Edge-Aligned PWM Mode

Location: [Section 16.4.2.3, Page 373](#)

The following text should be added to the end of Section 16.4.2.3:

Writing to TPMxSC cancels any values written to TPMxMODH and/or TPMxMODL and resets the coherency mechanism for the modulo registers. Writing to TPMxCnSC cancels any values written to the channel value registers and resets the coherency mechanism for TPMxCnVH:TPMxCnVL.

MC9S08DZ128

MC9S08DZ96

MC9S08DV128

MC9S08DV96

Data Sheet

HCS08

Microcontrollers

MC9S08DZ128

Rev. 1

5/2008

freescale.com

MC9S08DZ128 Series Features

8-Bit HCS08 Central Processor Unit (CPU)

- 40-MHz HCS08 CPU (20-MHz bus)
- HC08 instruction set with added BGND instruction
- Support for up to 32 interrupt/reset sources

On-Chip Memory

- FLASH read/program/erase over full operating voltage and temperature
- EEPROM in-circuit programmable memory; 8-byte single-page or 4-byte dual-page erase sector; Program and Erase while executing FLASH; Erase abort
- Random-access memory (RAM)

	MC9S08 DZ128	MC9S08 DZ96	MC9S08 DV128	MC9S08 DV96
FLASH	128K	96K	128K	96K
EEPROM	2K	2K	—	—
RAM	8K	6K	6K	4K

Power-Saving Modes

- Two very low power stop modes
- Reduced power wait mode
- Very low power real time interrupt for use in run, wait, and stop

Clock Source Options

- Oscillator (XOSC) — Loop-control Pierce oscillator; Crystal or ceramic resonator range of 31.25 kHz to 38.4 kHz or 1 MHz to 16 MHz
- Multi-purpose Clock Generator (MCG) — PLL and FLL modes; reference clock with nonvolatile trim (0.2% resolution, 1.5% tolerance over temperature with internal temperature compensation); External reference with oscillator/resonator options

System Protection

- Watchdog computer operating properly (COP) reset with option to run from backup dedicated 1-kHz internal clock source or bus clock; with optional windowed operation
- Low-voltage detection with reset or interrupt; selectable trip points
- Illegal opcode detection with reset
- Illegal address detection with reset
- FLASH and EEPROM block protect
- Loss-of-lock protection

Development Support

- Single-wire background debug interface
- On-chip, in-circuit emulation (ICE) with real-time bus capture

Peripherals

- **ADC** — 24-channel, 12-bit resolution, 2.5 μ s conversion time, automatic compare function, temperature sensor, internal bandgap reference channel
- **ACMPx** — Two analog comparators with selectable interrupt on rising, falling, or either edge of comparator output; compare option to fixed internal bandgap reference voltage; runs in stop3 mode
- **MSCAN** — CAN protocol - Version 2.0 A, B; standard and extended data frames; Support for remote frames; Five receive buffers with FIFO storage scheme; Flexible identifier acceptance filters programmable as: 2 x 32-bit, 4 x 16-bit, or 8 x 8-bit
- **SCIx** — Two SCIs supporting LIN 2.0 Protocol and SAE J2602 protocols; Full duplex non-return to zero (NRZ); Master extended break generation; Slave extended break detection; Wakeup on active edge
- **SPIx** — Up to two SPIs; Full-duplex or single-wire bidirectional; Double-buffered transmit and receive; Master or Slave mode; MSB-first or LSB-first shifting
- **IICx** — Up to two IICs; Up to 100 kbps with maximum bus loading; Multi-master operation; Programmable slave address; General Call Address; Interrupt driven byte-by-byte data transfer
- **TPMx** — One 6-channel (TPM1), one 2-channel (TPM2) and one 4-channel (TPM3); Selectable input capture, output compare, or buffered edge- and center-aligned PWM on each channel.
- **RTC** — (Real-time counter) 8-bit modulus counter with binary or decimal based prescaler; Real-time clock capabilities using external crystal and RTC for precise time base, time-of-day, calendar or task scheduling functions; Free running on-chip low power oscillator (1 kHz) for cyclic wake-up without external components

Input/Output

- Up to 87 general-purpose input/output (I/O) pins and 1 input-only pin
- Up to 32 interrupt pins with selectable polarity on each pin
- Hysteresis and configurable pull device on all input pins.
- Configurable slew rate and drive strength on all output pins.

Package Options

- 100-pin low-profile quad flat-pack (LQFP) — 14x14 mm
- 64-pin low-profile quad flat-pack (LQFP) — 10x10 mm
- 48-pin low-profile quad flat-pack (LQFP) — 7x7 mm

MC9S08DZ128 Series Data Sheet

Covers: MC9S08DZ128
MC9S08DZ96
MC9S08DV128
MC9S08DV96

MC9S08DZ128
Rev. 1
5/2008

Freescale™ and the Freescale logo are trademarks of Freescale Semiconductor, Inc.

© Freescale Semiconductor, Inc., 2007, 2008. All rights reserved.

Revision History

To provide the most up-to-date information, the revision of our documents on the World Wide Web will be the most current. Your printed copy may be an earlier revision. To verify you have the latest information available, refer to:

<http://freescale.com/>

The following revision history table summarizes changes contained in this document.

Revision Number	Revision Date	Description of Changes
1	4/2008	Initial Release

List of Chapters

Chapter	Title	Page
Chapter 1	Device Overview	21
Chapter 2	Pins and Connections	27
Chapter 3	Modes of Operation	39
Chapter 4	Memory	45
Chapter 5	Resets, Interrupts, and General System Control.....	85
Chapter 6	Parallel Input/Output Control.....	101
Chapter 7	Central Processor Unit (S08CPUV5).....	143
Chapter 8	Multi-Purpose Clock Generator (S08MCGV2)	165
Chapter 9	5-V Analog Comparator (S08ACMPV3).....	199
Chapter 10	Analog-to-Digital Converter (S08ADC12V1).....	207
Chapter 11	Inter-Integrated Circuit (S08IICV2)	233
Chapter 12	Freescale's Controller Area Network (S08MSCANV1)	253
Chapter 13	Serial Peripheral Interface (S08SPIV3)	307
Chapter 14	Serial Communications Interface (S08SCIV4).....	323
Chapter 15	Real-Time Counter (S08RTCV1)	343
Chapter 16	Timer Pulse-Width Modulator (S08TPMV3).....	353
Chapter 17	Development Support	379
Chapter 18	Debug Module (S08DBGV3) (128K).....	393
Appendix A	Electrical Characteristics.....	419
Appendix B	Ordering Information and Mechanical Drawings.....	447

Contents

Section Number	Title	Page
Chapter 1		
Device Overview		
1.1	Devices in the MC9S08DZ128 Series.....	21
1.2	MCU Block Diagram	23
1.3	System Clock Distribution	25
Chapter 2		
Pins and Connections		
2.1	Device Pin Assignment	27
2.2	Recommended System Connections	31
2.2.1	Power	32
2.2.2	Oscillator	32
2.2.3	RESET	32
2.2.4	Background / Mode Select (BKGD/MS)	33
2.2.5	ADC Reference (V_{REFH} , V_{REFL}) Pins	33
2.2.6	General-Purpose I/O and Peripheral Ports	33
Chapter 3		
Modes of Operation		
3.1	Introduction	39
3.2	Features	39
3.3	Run Mode.....	39
3.4	Active Background Mode.....	39
3.5	Wait Mode	40
3.6	Stop Modes.....	41
3.6.1	Stop3 Mode	41
3.6.2	Stop2 Mode	42
3.6.3	On-Chip Peripheral Modules in Stop Modes	42
Chapter 4		
Memory		
4.1	MC9S08DZ128 Series Memory Map	45
4.2	Reset and Interrupt Vector Assignments	49
4.3	Register Addresses and Bit Assignments.....	51
4.4	Memory Management Unit	61
4.4.1	Features	61
4.4.2	Memory Expansion	61

Section Number	Title	Page
4.4.3	MMU Registers and Control Bits	63
4.5	RAM.....	66
4.6	FLASH and EEPROM	67
4.6.1	Features	67
4.6.2	Program and Erase Times	67
4.6.3	Program and Erase Command Execution	68
4.6.4	Burst Program Execution	69
4.6.5	Sector Erase Abort	72
4.6.6	Access Errors	73
4.6.7	Block Protection	74
4.6.8	Vector Redirection	74
4.6.9	Security	74
4.6.10	EEPROM Mapping	76
4.6.11	FLASH and EEPROM Registers and Control Bits	76

Chapter 5 Resets, Interrupts, and General System Control

5.1	Introduction	85
5.2	Features	85
5.3	MCU Reset.....	85
5.4	Computer Operating Properly (COP) Watchdog.....	86
5.5	Interrupts	87
5.5.1	Interrupt Stack Frame	88
5.5.2	External Interrupt Request (IRQ) Pin	88
5.5.3	Interrupt Vectors, Sources, and Local Masks	89
5.6	Low-Voltage Detect (LVD) System	91
5.6.1	Power-On Reset Operation	91
5.6.2	Low-Voltage Detection (LVD) Reset Operation	91
5.6.3	Low-Voltage Warning (LVW) Interrupt Operation	92
5.7	MCLK Output	92
5.8	Reset, Interrupt, and System Control Registers and Control Bits	92
5.8.1	Interrupt Pin Request Status and Control Register (IRQSC)	92
5.8.2	System Reset Status Register (SRS)	94
5.8.3	System Background Debug Force Reset Register (SBDFR)	95
5.8.4	System Options Register 1 (SOPT1)	96
5.8.5	System Options Register 2 (SOPT2)	97
5.8.6	System Device Identification Register (SDIDH, SDIDL)	98
5.8.7	System Power Management Status and Control 1 Register (SPMSC1)	99
5.8.8	System Power Management Status and Control 2 Register (SPMSC2)	100

Section Number	Title	Page
Chapter 6		
Parallel Input/Output Control		
6.1	Port Data and Data Direction	101
6.2	Pull-up, Slew Rate, and Drive Strength.....	102
6.3	Pin Interrupts	103
6.3.1	Edge Only Sensitivity	103
6.3.2	Edge and Level Sensitivity	103
6.3.3	Pull-up/Pull-down Resistors	104
6.3.4	Pin Interrupt Initialization	104
6.4	Pin Behavior in Stop Modes.....	104
6.5	Parallel I/O and Pin Control Registers	104
6.5.1	Port A Registers	105
6.5.2	Port B Registers	109
6.5.3	Port C Registers	113
6.5.4	Port D Registers	116
6.5.5	Port E Registers	120
6.5.6	Port F Registers	123
6.5.7	Port G Registers	126
6.5.8	Port H Registers	129
6.5.9	Port J Registers	132
6.5.10	Port K Registers	136
6.5.11	Port L Registers	139

Chapter 7		
Central Processor Unit (S08CPUV5)		
7.1	Introduction	143
7.1.1	Features	143
7.2	Programmer's Model and CPU Registers	144
7.2.1	Accumulator (A)	144
7.2.2	Index Register (H:X)	144
7.2.3	Stack Pointer (SP)	145
7.2.4	Program Counter (PC)	145
7.2.5	Condition Code Register (CCR)	145
7.3	Addressing Modes	147
7.3.1	Inherent Addressing Mode (INH)	147
7.3.2	Relative Addressing Mode (REL)	147
7.3.3	Immediate Addressing Mode (IMM)	147
7.3.4	Direct Addressing Mode (DIR)	148
7.3.5	Extended Addressing Mode (EXT)	148
7.3.6	Indexed Addressing Mode	148
7.4	Special Operations.....	149
7.4.1	Reset Sequence	149

Section Number	Title	Page
7.4.2	Interrupt Sequence	149
7.4.3	Wait Mode Operation	150
7.4.4	Stop Mode Operation	150
7.4.5	BGND Instruction	151
7.5	CALL and RTC Instructions	151
7.6	HCS08 Instruction Set Summary	153

Chapter 8 Multi-Purpose Clock Generator (S08MCGV2)

8.1	Introduction	165
8.1.1	Features	167
8.1.2	Modes of Operation	169
8.2	External Signal Description	169
8.3	Register Definition	170
8.3.1	MCG Control Register 1 (MCGC1)	170
8.3.2	MCG Control Register 2 (MCGC2)	172
8.3.3	MCG Trim Register (MCGTRM)	173
8.3.4	MCG Status and Control Register (MCGSC)	174
8.3.5	MCG Control Register 3 (MCGC3)	175
8.3.6	MCG Test and Control Register (MCGT)	177
8.4	Functional Description	178
8.4.1	Operational Modes	178
8.4.2	Mode Switching	182
8.4.3	Bus Frequency Divider	183
8.4.4	Low Power Bit Usage	183
8.4.5	Internal Reference Clock	183
8.4.6	External Reference Clock	183
8.4.7	Fixed Frequency Clock	184
8.5	Initialization / Application Information	185
8.5.1	MCG Module Initialization Sequence	185
8.5.2	Using a 32.768 kHz Reference	186
8.5.3	MCG Mode Switching	187
8.5.4	Calibrating the Internal Reference Clock (IRC)	195

Chapter 9 5-V Analog Comparator (S08ACMPV3)

9.1	Introduction	199
9.1.1	ACMP Configuration Information	199
9.1.2	Features	201
9.1.3	Modes of Operation	201
9.1.4	Block Diagram	201
9.2	External Signal Description	203

Section Number	Title	Page
9.3	Memory Map	203
9.3.1	Register Descriptions	203
9.4	Functional Description	205

Chapter 10 Analog-to-Digital Converter (S08ADC12V1)

10.1	Introduction	207
10.1.1	Channel Assignments	207
10.1.2	Analog Power and Ground Signal Names	207
10.1.3	Alternate Clock	208
10.1.4	Hardware Trigger	208
10.1.5	Temperature Sensor	209
10.1.6	Features	211
10.1.7	ADC Module Block Diagram	211
10.2	External Signal Description	212
10.2.1	Analog Power (V_{DDAD})	213
10.2.2	Analog Ground (V_{SSAD})	213
10.2.3	Voltage Reference High (V_{REFH})	213
10.2.4	Voltage Reference Low (V_{REFL})	213
10.2.5	Analog Channel Inputs (ADx)	213
10.3	Register Definition	213
10.3.1	Status and Control Register 1 (ADCSC1)	213
10.3.2	Status and Control Register 2 (ADCSC2)	215
10.3.3	Data Result High Register (ADCRH)	215
10.3.4	Data Result Low Register (ADCRL)	216
10.3.5	Compare Value High Register (ADCCVH)	216
10.3.6	Compare Value Low Register (ADCCVL)	217
10.3.7	Configuration Register (ADCCFG)	217
10.3.8	Pin Control 1 Register (APCTL1)	218
10.3.9	Pin Control 2 Register (APCTL2)	219
10.3.10	Pin Control 3 Register (APCTL3)	220
10.4	Functional Description	221
10.4.1	Clock Select and Divide Control	222
10.4.2	Input Select and Pin Control	222
10.4.3	Hardware Trigger	222
10.4.4	Conversion Control	222
10.4.5	Automatic Compare Function	225
10.4.6	MCU Wait Mode Operation	225
10.4.7	MCU Stop3 Mode Operation	226
10.4.8	MCU Stop2 Mode Operation	226
10.5	Initialization Information	227
10.5.1	ADC Module Initialization Example	227

Section Number	Title	Page
10.6	Application Information	229
10.6.1	External Pins and Routing	229
10.6.2	Sources of Error	230

Chapter 11 Inter-Integrated Circuit (S08IICV2)

11.1	Introduction	233
11.1.1	IIC1 Configuration Information	233
11.1.2	Features	235
11.1.3	Modes of Operation	235
11.1.4	Block Diagram	236
11.2	External Signal Description	236
11.2.1	SCL — Serial Clock Line	236
11.2.2	SDA — Serial Data Line	236
11.3	Register Definition	236
11.3.1	IIC Address Register (IICxA)	237
11.3.2	IIC Frequency Divider Register (IICxF)	237
11.3.3	IIC Control Register (IICxC1)	240
11.3.4	IIC Status Register (IICxS)	241
11.3.5	IIC Data I/O Register (IICxD)	242
11.3.6	IIC Control Register 2 (IICxC2)	242
11.4	Functional Description	243
11.4.1	IIC Protocol	243
11.4.2	10-bit Address	247
11.4.3	General Call Address	248
11.5	Resets	248
11.6	Interrupts	248
11.6.1	Byte Transfer Interrupt	248
11.6.2	Address Detect Interrupt	248
11.6.3	Arbitration Lost Interrupt	248
11.7	Initialization/Application Information	250

Chapter 12 Freescale's Controller Area Network (S08MSCANV1)

12.1	Introduction	253
12.1.1	Features	255
12.1.2	Modes of Operation	255
12.1.3	Block Diagram	256
12.2	External Signal Description	256
12.2.1	RXCAN — CAN Receiver Input Pin	256
12.2.2	TXCAN — CAN Transmitter Output Pin	256
12.2.3	CAN System	256

Section Number	Title	Page
12.3	Register Definition	257
12.3.1	MSCAN Control Register 0 (CANCTL0)	257
12.3.2	MSCAN Control Register 1 (CANCTL1)	260
12.3.3	MSCAN Bus Timing Register 0 (CANBTR0)	261
12.3.4	MSCAN Bus Timing Register 1 (CANBTR1)	262
12.3.5	MSCAN Receiver Interrupt Enable Register (CANRIER)	265
12.3.6	MSCAN Transmitter Flag Register (CANTFLG)	266
12.3.7	MSCAN Transmitter Interrupt Enable Register (CANTIER)	267
12.3.8	MSCAN Transmitter Message Abort Request Register (CANTARQ)	268
12.3.9	MSCAN Transmitter Message Abort Acknowledge Register (CANTAACK)	269
12.3.10	MSCAN Transmit Buffer Selection Register (CANTBSEL)	269
12.3.11	MSCAN Identifier Acceptance Control Register (CANIDAC)	270
12.3.12	MSCAN Miscellaneous Register (CANMISC)	271
12.3.13	MSCAN Receive Error Counter (CANRXERR)	272
12.3.14	MSCAN Transmit Error Counter (CANTXERR)	273
12.3.15	MSCAN Identifier Acceptance Registers (CANIDAR0-7)	273
12.3.16	MSCAN Identifier Mask Registers (CANIDMR0–CANIDMR7)	274
12.4	Programmer’s Model of Message Storage	275
12.4.1	Identifier Registers (IDR0–IDR3)	278
12.4.2	IDR0–IDR3 for Standard Identifier Mapping	280
12.4.3	Data Segment Registers (DSR0-7)	281
12.4.4	Data Length Register (DLR)	282
12.4.5	Transmit Buffer Priority Register (TBPR)	283
12.4.6	Time Stamp Register (TSRH–TSRL)	283
12.5	Functional Description	284
12.5.1	General	284
12.5.2	Message Storage	285
12.5.3	Identifier Acceptance Filter	288
12.5.4	Modes of Operation	295
12.5.5	Low-Power Options	296
12.5.6	Reset Initialization	302
12.5.7	Interrupts	302
12.6	Initialization/Application Information	304
12.6.1	MSCAN initialization	304
12.6.2	Bus-Off Recovery	305

Chapter 13

Serial Peripheral Interface (S08SPIV3)

13.1	Introduction	307
13.1.1	Features	309
13.1.2	Block Diagrams	309
13.1.3	SPI Baud Rate Generation	311

Section Number	Title	Page
13.2	External Signal Description	312
13.2.1	SPSCK — SPI Serial Clock	312
13.2.2	MOSI — Master Data Out, Slave Data In	312
13.2.3	MISO — Master Data In, Slave Data Out	312
13.2.4	\overline{SS} — Slave Select	312
13.3	Modes of Operation.....	313
13.3.1	SPI in Stop Modes	313
13.4	Register Definition	313
13.4.1	SPI Control Register 1 (SPIxC1)	313
13.4.2	SPI Control Register 2 (SPIxC2)	314
13.4.3	SPI Baud Rate Register (SPIxBR)	315
13.4.4	SPI Status Register (SPIxS)	316
13.4.5	SPI Data Register (SPIxD)	317
13.5	Functional Description	318
13.5.1	SPI Clock Formats	318
13.5.2	SPI Interrupts	321
13.5.3	Mode Fault Detection	321

Chapter 14

Serial Communications Interface (S08SCIV4)

14.1	Introduction	323
14.1.1	SCI2 Configuration Information	323
14.1.2	Features	325
14.1.3	Modes of Operation	325
14.1.4	Block Diagram	326
14.2	Register Definition	328
14.2.1	SCI Baud Rate Registers (SCIxBDH, SCIxBDL)	328
14.2.2	SCI Control Register 1 (SCIxC1)	329
14.2.3	SCI Control Register 2 (SCIxC2)	330
14.2.4	SCI Status Register 1 (SCIxS1)	331
14.2.5	SCI Status Register 2 (SCIxS2)	333
14.2.6	SCI Control Register 3 (SCIxC3)	334
14.2.7	SCI Data Register (SCIxD)	335
14.3	Functional Description	335
14.3.1	Baud Rate Generation	335
14.3.2	Transmitter Functional Description	336
14.3.3	Receiver Functional Description	337
14.3.4	Interrupts and Status Flags	339
14.3.5	Additional SCI Functions	340

Chapter 15
Real-Time Counter (S08RTCV1)

15.1	Introduction	343
15.1.1	RTC Clock Signal Names	343
15.1.2	Features	345
15.1.3	Modes of Operation	345
15.1.4	Block Diagram	346
15.2	External Signal Description	346
15.3	Register Definition	346
15.3.1	RTC Status and Control Register (RTCSA)	347
15.3.2	RTC Counter Register (RTCCNT)	348
15.3.3	RTC Modulo Register (RTCMOD)	348
15.4	Functional Description	348
15.4.1	RTC Operation Example	349
15.5	Initialization/Application Information	350

Chapter 16
Timer Pulse-Width Modulator (S08TPMV3)

16.1	Introduction	353
16.1.1	Features	355
16.1.2	Modes of Operation	355
16.1.3	Block Diagram	356
16.2	Signal Description	358
16.2.1	Detailed Signal Descriptions	358
16.3	Register Definition	362
16.3.1	TPM Status and Control Register (TPMxSC)	362
16.3.2	TPM-Counter Registers (TPMxCNTH:TPMxCNTL)	363
16.3.3	TPM Counter Modulo Registers (TPMxMODH:TPMxMODL)	364
16.3.4	TPM Channel n Status and Control Register (TPMxCnSC)	365
16.3.5	TPM Channel Value Registers (TPMxCnVH:TPMxCnVL)	367
16.4	Functional Description	368
16.4.1	Counter	369
16.4.2	Channel Mode Selection	371
16.5	Reset Overview	374
16.5.1	General	374
16.5.2	Description of Reset Operation	374
16.6	Interrupts	374
16.6.1	General	374
16.6.2	Description of Interrupt Operation	375
16.7	The Differences from TPM v2 to TPM v3	376

Section Number	Title	Page
Chapter 17		
Development Support		
17.1	Introduction	379
17.1.1	Forcing Active Background	379
17.1.2	Features	380
17.2	Background Debug Controller (BDC)	380
17.2.1	BKGD Pin Description	381
17.2.2	Communication Details	381
17.2.3	BDC Commands	385
17.2.4	BDC Hardware Breakpoint	387
17.3	Register Definition	387
17.3.1	BDC Registers and Control Bits	388
17.3.2	System Background Debug Force Reset Register (SBDFR)	390

Chapter 18
Debug Module (S08DBGV3) (128K)

18.1	Introduction	393
18.1.1	Features	393
18.1.2	Modes of Operation	394
18.1.3	Block Diagram	394
18.2	Signal Description	394
18.3	Memory Map and Registers	395
18.3.1	Module Memory Map	395
18.3.2	396
18.3.3	Register Descriptions	397
18.4	Functional Description	410
18.4.1	Comparator	410
18.4.2	Breakpoints	411
18.4.3	Trigger Selection	411
18.4.4	Trigger Break Control (TBC)	412
18.4.5	FIFO	415
18.4.6	Interrupt Priority	416
18.5	Resets	416
18.6	Interrupts	417
18.7	Electrical Specifications	417

Appendix A
Electrical Characteristics

A.1	Introduction	419
A.2	Parameter Classification	419
A.3	Absolute Maximum Ratings	419
A.4	Thermal Characteristics	420

Section Number	Title	Page
A.5	ESD Protection and Latch-Up Immunity	422
A.6	DC Characteristics	423
A.7	Supply Current Characteristics	427
A.8	Analog Comparator (ACMP) Electricals	429
A.9	ADC Characteristics	431
A.10	External Oscillator (XOSC) Characteristics	435
A.11	MCG Specifications	436
A.12	AC Characteristics	438
	A.12.1 Control Timing	438
	A.12.2 Timer/PWM	440
	A.12.3 MSCAN	441
	A.12.4 SPI	442
A.13	FLASH and EEPROM	445
A.14	EMC Performance	446
	A.14.1 Radiated Emissions	446

Appendix B

Ordering Information and Mechanical Drawings

B.1	Ordering Information	447
	B.1.1 MC9S08DZ128 Series Devices	447
B.2	Mechanical Drawings	448

Chapter 1

Device Overview

MC9S08DZ128 Series devices are members of the low-cost, high-performance HCS08 Family of 8-bit microcontroller units (MCUs). All MCUs in the family use the enhanced HCS08 core and are available with a variety of modules, memory sizes, memory types, and package types.

1.1 Devices in the MC9S08DZ128 Series

This data sheet covers members of the MC9S08DZ128 Series of MCUs:

- MC9S08DZ128
- MC9S08DZ96
- MC9S08DV128
- MC9S08DV96

Table 1-1 summarizes the feature set available in the MC9S08DZ128 Series.

Table 1-1. MC9S08DZ128 Series Features by MCU and Pin Count

Feature	MC9S08DZ128			MC9S08DZ96			MC9S08DV128			MC9S08DV96		
	100	64	48	100	64	48	100	64	48	100	64	48
FLASH (bytes)	131,072			98,304			131,072			98,304		
RAM (bytes)	8192			6016			6016			4096		
EEPROM (bytes)	2048			2048			—			—		
Pin quantity	100	64	48	100	64	48	100	64	48	100	64	48
Pin Interrupts	32	24	24	32	24	24	32	24	24	32	24	24
ACMP1	yes			yes			yes			yes		
ACMP2	yes ¹			yes ¹			yes ¹			yes ¹		
ADC channels	24	24	16	24	24	16	24	24	16	24	24	16
DBG	yes			yes			yes			yes		
IIC1	yes			yes			yes			yes		
IIC2	yes	no	no	yes	no	no	yes	no	no	yes	no	no
IRQ	yes			yes			yes			yes		
MCG	yes			yes			yes			yes		
MSCAN	yes			yes			yes			yes		
RTC	yes			yes			yes			yes		
SCI1	yes			yes			yes			yes		
SCI2	yes			yes			yes			yes		
SPI1	yes			yes			yes			yes		
SPI2	yes	no	no	yes	no	no	yes	no	no	yes	no	no
TPM1 channels	6			6			6			6		
TPM2 channels	2			2			2			2		
TPM3 channels	4 ²			4 ²			4 ²			4 ²		
XOSC	yes			yes			yes			yes		
COP Watchdog	yes			yes			yes			yes		

¹ ACMP20 is not available in the 48-pin package.

² TPM3 pins are not available in the 64-pin and 48-pin packages.

Table 1-2 provides the functional version of the on-chip modules.

Table 1-2. Module Versions

Module		Version
Central Processor Unit	(CPU)	5
Analog Comparator (5V)	(ACMP_5V)	3
Analog-to-Digital Converter	(ADC)	1
Debug Module	(DBG)	3
Inter-Integrated Circuit	(IIC)	2
Multi-Purpose Clock Generator	(MCG)	2
Freescale's Controller Area Network	(MSCAN)	1
Serial Peripheral Interface	(SPI)	3
Serial Communications Interface	(SCI)	4
Real-Time Counter	(RTC)	1
Timer Pulse Width Modulator	(TPM)	3

1.2 MCU Block Diagram

Figure 1-1 is the MC9S08DZ128 Series system-level block diagram.

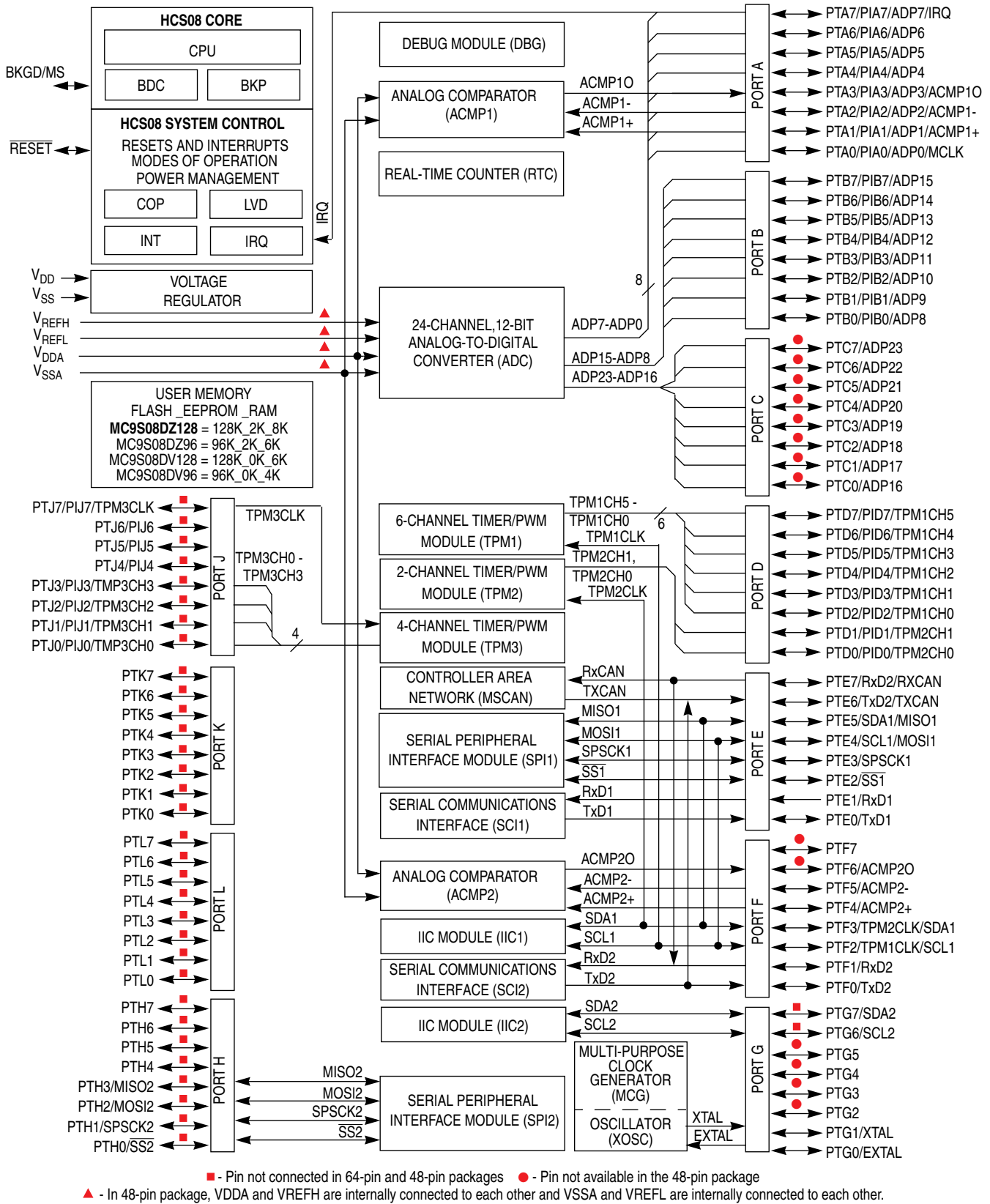

Figure 1-1. MC9S08DZ128 Block Diagram

1.3 System Clock Distribution

Figure 1-2 shows a simplified clock connection diagram. Some modules in the MCU have selectable clock inputs as shown. The clock inputs to the modules indicate the clock(s) that are used to drive the module function.

The following are the clocks used in this MCU:

- **BUSCLK** — The frequency of the bus is always half of MCGOUT.
- **LPO** — Independent 1-kHz clock that can be selected as the source for the COP and RTC modules.
- **MCGOUT** — Primary output of the MCG and is twice the bus frequency.
- **MCGLCLK** — Development tools can select this clock source to speed up BDC communications in systems where BUSCLK is configured to run at a very slow frequency.
- **MCGERCLK** — External reference clock can be selected as the RTC clock source. It can also be used as the alternate clock for the ADC and MSCAN.
- **MCGIRCLK** — Internal reference clock can be selected as the RTC clock source.
- **MCGFFCLK** — Fixed frequency clock can be selected as clock source for the TPMx.
- **TPM1CLK** — External input clock source for TPM1.
- **TPM2CLK** — External input clock source for TPM2.
- **TPM3CLK** — External input clock source for TPM3.

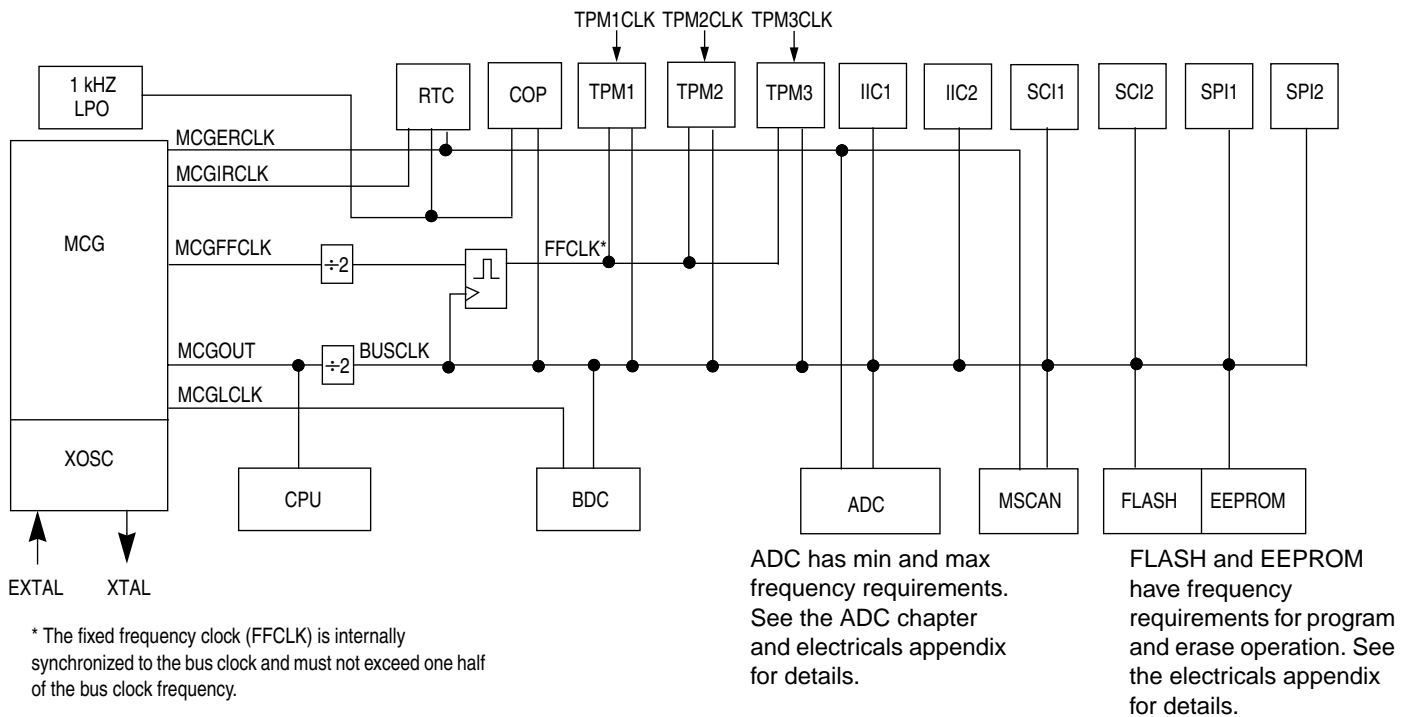

Figure 1-2. System Clock Distribution Diagram

Chapter 2

Pins and Connections

This section describes signals that connect to package pins. It includes pinout diagrams, recommended system connections, and detailed discussions of signals.

2.1 Device Pin Assignment

This section shows the pin assignments for MC9S08DZ128 Series MCUs in the available packages.

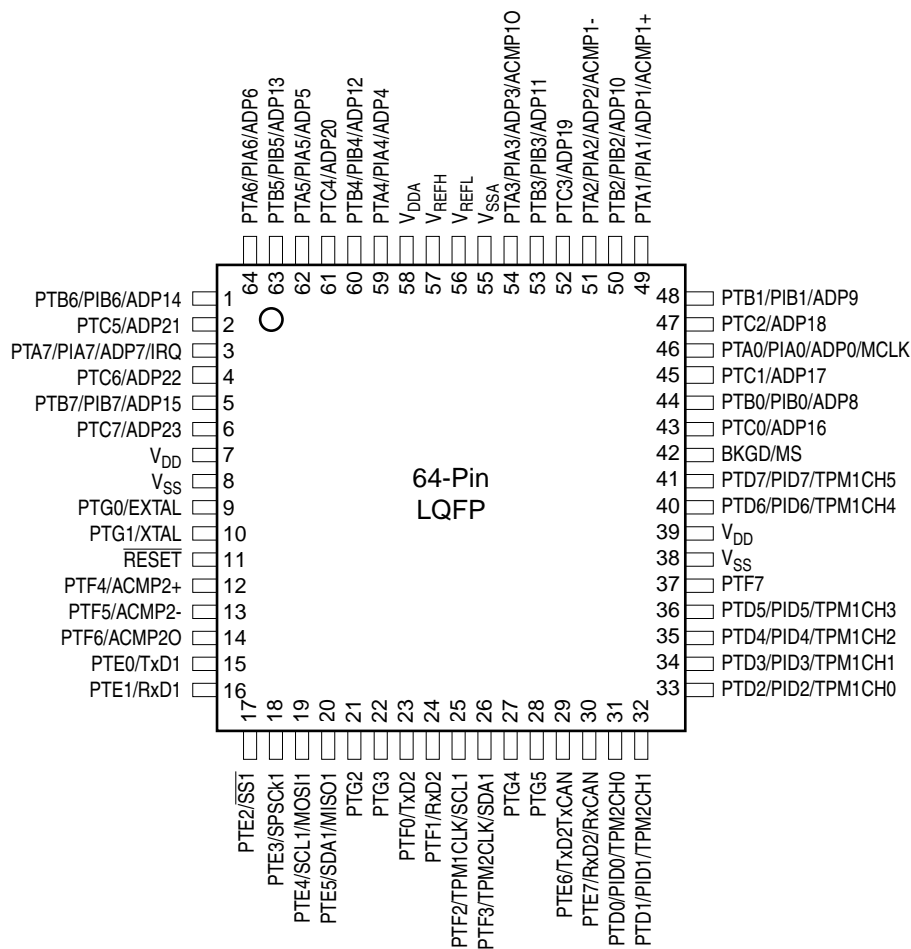
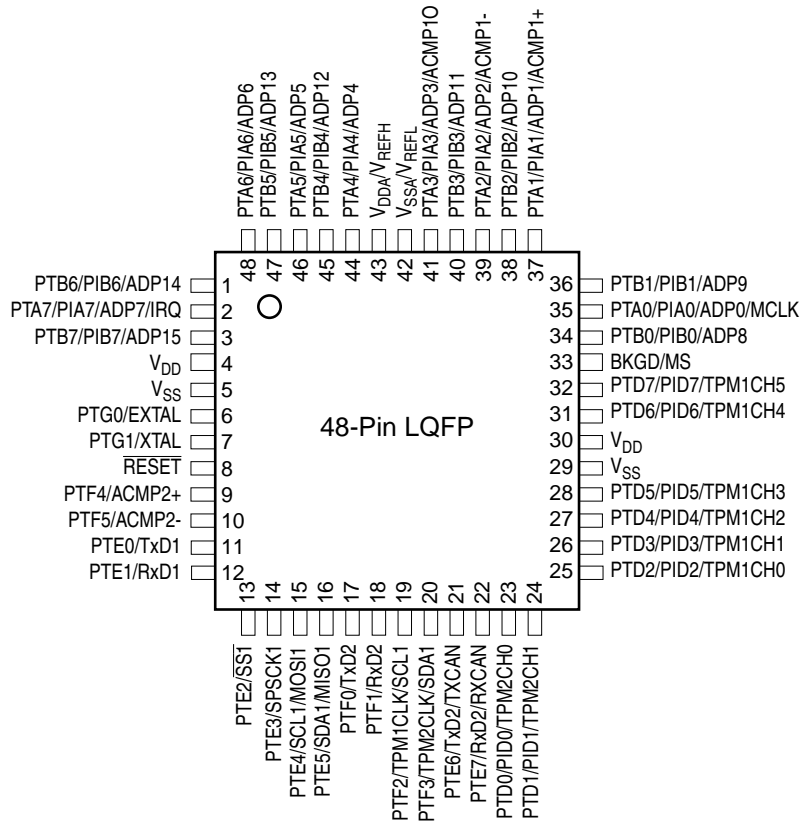

Figure 2-2. MC9S08DZ128 Series in 64-Pin LQFP Package



V_{REFH} and V_{REFL} are internally connected to V_{DDA} and V_{SSA} , respectively.

Figure 2-3. MC9S08DZ128 Series in 48-Pin LQFP

2.2 Recommended System Connections

Figure 2-4 shows pin connections that are common to MC9S08DZ128 Series application systems.

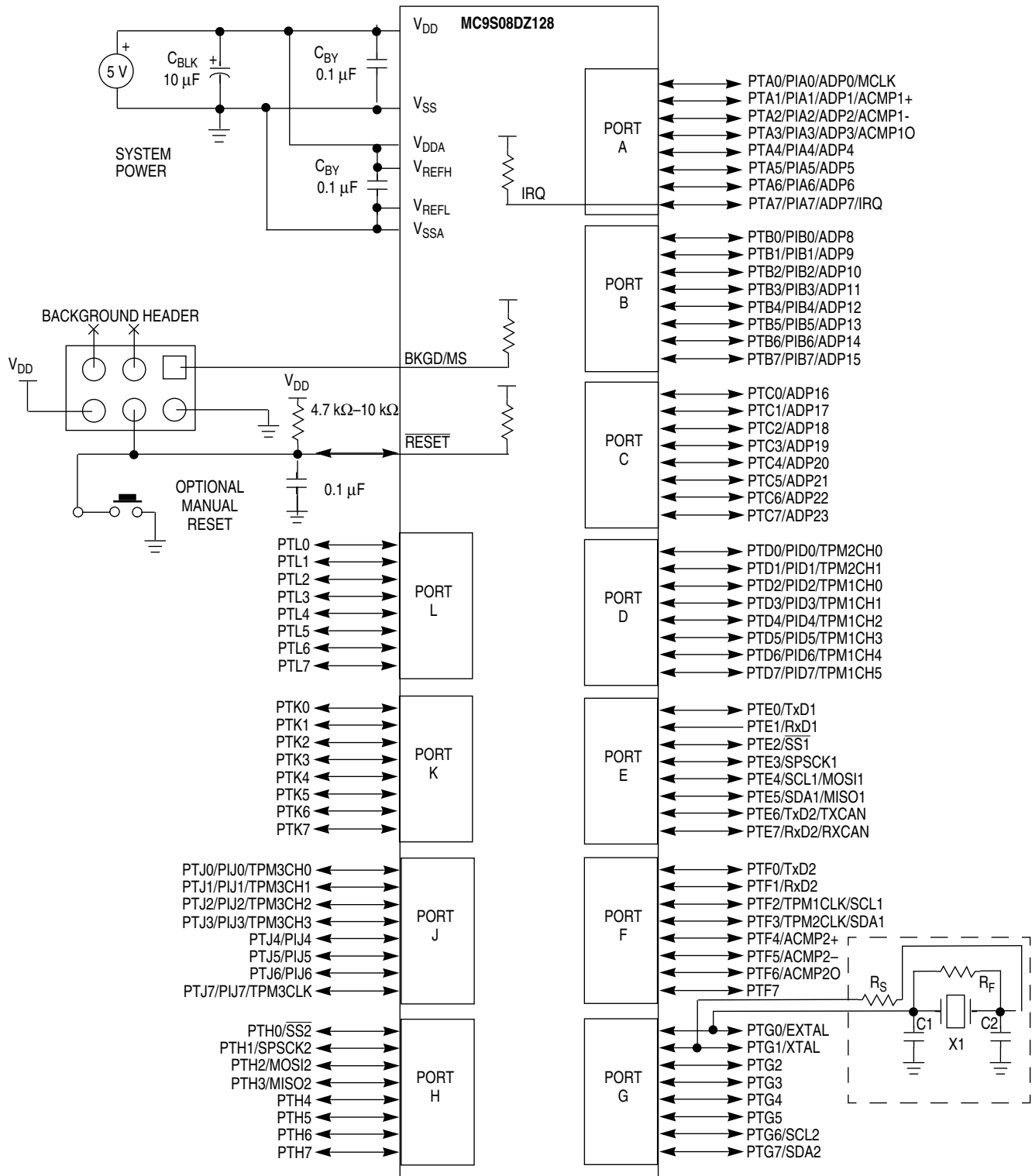

Figure 2-4. Basic System Connections (Shown in 100Pin Package)

2.2.1 Power

V_{DD} and V_{SS} are the primary power supply pins for the MCU. This voltage source supplies power to all I/O buffer circuitry and to an internal voltage regulator. The internal voltage regulator provides regulated lower-voltage source to the CPU and other internal circuitry of the MCU.

Typically, application systems have two separate capacitors across the power pins. In this case, there should be a bulk electrolytic capacitor, such as a 10- μ F tantalum capacitor, to provide bulk charge storage for the overall system and a 0.1- μ F ceramic bypass capacitor located as near to the MCU power pins as practical to suppress high-frequency noise. The MC9S08DZ128 Series has up to three V_{DD} pins. Each pin must have a bypass capacitor for best noise suppression.

V_{DDA} and V_{SSA} are the analog power supply pins for the MCU. This voltage source supplies power to the ADC module. A 0.1- μ F ceramic bypass capacitor should be located as near to the MCU power pins as practical to suppress high-frequency noise.

2.2.2 Oscillator

Immediately after reset, the MCU uses an internally generated clock provided by the multi-purpose clock generator (MCG) module. For more information on the MCG, see [Chapter 8, “Multi-Purpose Clock Generator \(S08MCGV2\).”](#)

The oscillator (XOSC) in this MCU is a Pierce oscillator that can accommodate a crystal or ceramic resonator. Rather than a crystal or ceramic resonator, an external oscillator can be connected to the EXTAL input pin.

Refer to [Figure 2-4](#) for the following discussion. R_S (when used) and R_F should be low-inductance resistors such as carbon composition resistors. Wire-wound resistors and some metal film resistors have too much inductance. C1 and C2 normally should be high-quality ceramic capacitors that are specifically designed for high-frequency applications.

R_F is used to provide a bias path to keep the EXTAL input in its linear range during crystal startup; its value is not generally critical. Typical systems use 1 M Ω to 10 M Ω . Higher values are sensitive to humidity, and lower values reduce gain and (in extreme cases) could prevent startup.

C1 and C2 are typically in the 5-pF to 25-pF range and are chosen to match the requirements of a specific crystal or resonator. Be sure to take into account printed circuit board (PCB) capacitance and MCU pin capacitance when selecting C1 and C2. The crystal manufacturer typically specifies a load capacitance which is the series combination of C1 and C2 (which are usually the same size). As a first-order approximation, use 10 pF as an estimate of combined pin and PCB capacitance for each oscillator pin (EXTAL and XTAL).

2.2.3 $\overline{\text{RESET}}$

$\overline{\text{RESET}}$ is a dedicated pin with a pull-up device built in. It has input hysteresis, a high current output driver, and no output slew rate control. Internal power-on reset and low-voltage reset circuitry typically make external reset circuitry unnecessary. This pin is normally connected to the standard 6-pin background debug connector so a development system can directly reset the MCU system. If desired, a manual external reset can be added by supplying a simple switch to ground (pull reset pin low to force a reset).

Whenever any reset is initiated (whether from an external signal or from an internal system), the RESET pin is driven low for about 34 bus cycles. The reset circuitry decodes the cause of reset and records it by setting a corresponding bit in the system reset status register (SRS).

2.2.4 Background / Mode Select (BKGD/MS)

While in reset, the BKGD/MS pin functions as a mode select pin. Immediately after reset rises, the pin functions as the background pin and can be used for background debug communication. While functioning as a background or mode select pin, the pin includes an internal pull-up device, input hysteresis, a standard output driver, and no output slew rate control.

If nothing is connected to this pin, the MCU will enter normal operating mode at the rising edge of reset. If a debug system is connected to the 6-pin standard background debug header, it can hold BKGD low during the rising edge of reset which forces the MCU to active background mode.

The BKGD/MS pin is used primarily for background debug controller (BDC) communications using a custom protocol that uses 16 clock cycles of the target MCU's BDC clock per bit time. The target MCU's BDC clock could be as fast as the bus clock rate, so there should never be any significant capacitance connected to the BKGD/MS pin that could interfere with background serial communications.

Although the BKGD/MS pin is a pseudo open-drain pin, the background debug communication protocol provides brief, actively driven, high speedup pulses to ensure fast rise times. Small capacitances from cables and the absolute value of the internal pull-up device play almost no role in determining rise and fall times on the BKGD/MS pin.

2.2.5 ADC Reference (V_{REFH} , V_{REFL}) Pins

The V_{REFH} and V_{REFL} pins are the voltage reference high and voltage reference low inputs, respectively, for the ADC module.

2.2.6 General-Purpose I/O and Peripheral Ports

The MC9S08DZ128 Series series of MCUs support up to 87 general-purpose I/O pins and 1 input-only pin, which are shared with on-chip peripheral functions (timers, serial I/O, ADC, MSCAN, etc.).

When a port pin is configured as a general-purpose output or a peripheral uses the port pin as an output, software can select one of two drive strengths and enable or disable slew rate control. When a port pin is configured as a general-purpose input or a peripheral uses the port pin as an input, software can enable a pull-up device. Immediately after reset, all of these pins are configured as high-impedance general-purpose inputs with internal pull-up devices disabled.

When an on-chip peripheral system is controlling a pin, data direction control bits still determine what is read from port data registers even though the peripheral module controls the pin direction by controlling the enable for the pin's output buffer. For information about controlling these pins as general-purpose I/O pins, see [Chapter 6, "Parallel Input/Output Control."](#)

NOTE

To avoid extra current drain from floating input pins, the reset initialization routine in the application program should either enable on-chip pull-up devices or change the direction of unused or non-bonded pins to outputs so they do not float.

Table 2-1. Pin Availability by Package Pin-Count

Pin Number			<-- Lowest Priority --> Highest			
100	64	48	Port Pin/Interrupt		Alt 1	Alt 2
1	1	1	PTB6	PIB6	ADP14	
2	2	—	PTC5		ADP21	
3	3	2	PTA7	PIA7	ADP7	IRQ
4	4	—	PTC6		ADP22	
5	5	3	PTB7	PIB7	ADP15	
6	6	—	PTC7		ADP23	
7	—	—	PTJ0	PIJ0	TPM3CH0	
8	—	—	PTJ1	PIJ1	TPM3CH1	
9	—	—	PTJ2	PIJ2	TPM3CH2	
10	—	—	PTJ3	PIJ3	TPM3CH3	
11	7	4				V _{DD}
12	8	5				V _{SS}
13	9	6	PTG0		EXTAL	
14	10	7	PTG1		XTAL	
15	11	8				RESET
16	—	—	PTL5			
17	12	9	PTF4			ACMP2+
18	13	10	PTF5			ACMP2-
19	14	—	PTF6			ACMP2O
20	—	—	PTJ4	PIJ4		
21	—	—	PTJ5	PIJ5		
22	—	—	PTJ6	PIJ6		
23	—	—	PTJ7	PIJ7	TPM3CLK	
24	15	11	PTE0			TxD1
25	16	12	PTE1 ¹			RxD1

Table 2-1. Pin Availability by Package Pin-Count (continued)

Pin Number			<-- Lowest Priority --> Highest		
100	64	48	Port Pin/Interrupt	Alt 1	Alt 2
26	17	13	PTE2		SS1
27	18	14	PTE3		SPSCK1
28	19	15	PTE4	SCL1 ²	MOSI1
29	20	16	PTE5	SDA1 ²	MISO1
30	21	—	PTG2		
31	22	—	PTG3		
32	—	—	PTL6		
33	—	—	PTL7		
34	23	17	PTF0		TxD2 ³
35	24	18	PTF1		RxD2 ³
36	25	19	PTF2	TPM1CLK	SCL1 ²
37	26	20	PTF3	TPM2CLK	SDA1 ²
38	—	—			V _{DD}
39	—	—			V _{SS}
40	27	—	PTG4		
41	28	—	PTG5		
42	—	—	PTG6		SCL2
43	—	—	PTG7		SDA2
44	29	21	PTE6	TxD2 ³	TXCAN
45	30	22	PTE7	RxD2 ³	RxCAN
46	—	—	PTL0		
47	—	—	PTL1		
48	—	—	PTL2		
49	31	23	PTD0	PID0	TPM2CH0
50	32	24	PTD1	PID1	TPM2CH1

Table 2-1. Pin Availability by Package Pin-Count (continued)

Pin Number			<-- Lowest Priority --> Highest			
100	64	48	Port Pin/Interrupt		Alt 1	Alt 2
51	33	25	PTD2	PID2		TPM1CH0
52	34	26	PTD3	PID3		TPM1CH1
53	35	27	PTD4	PID4		TPM1CH2
54	36	28	PTD5	PID5		TPM1CH3
55	—	—	PTH0			SS2
56	—	—	PTH1			SPSCK2
57	—	—	PTH2			MOSI2
58	—	—	PTH3			MISO2
59	37	—	PTF7			
60	—	—	PTL3			
61	38	29				V _{SS}
62	39	30				V _{DD}
63	40	31	PTD6	PID6		TPM1CH4
64	41	32	PTD7	PID7		TPM1CH5
65	42	33			BKGD	MS
66	—	—	PTH4			
67	—	—	PTH5			
68	—	—	PTH6			
69	—	—	PTH7			
70	43	—	PTC0		ADP16	
71	44	34	PTB0	PIB0	ADP8	
72	45	—	PTC1		ADP17	
73	46	35	PTA0	PIA0	ADP0	MCLK
74	47	—	PTC2		ADP18	
75	48	36	PTB1	PIB1	ADP9	
76	49	37	PTA1	PIA1	ADP1 ⁴	ACMP1+ ⁴
77	50	38	PTB2	PIB2	ADP10	
78	51	39	PTA2	PIA2	ADP2 ⁴	ACMP1- ⁴
79	52	—	PTC3		ADP19	
80	53	40	PTB3	PIB3	ADP11	
81	54	41	PTA3	PIA3	ADP3	ACMP10
82	—	—	PTL4			
83	—	—	PTK0			
84	—	—	PTK1			
85	—	—	PTK2			
86	—	—	PTK3			
87	55	42				V _{SSA}
88	56					V _{REFL}

Table 2-1. Pin Availability by Package Pin-Count (continued)

Pin Number			<-- Lowest Priority --> Highest			
100	64	48	Port Pin/Interrupt		Alt 1	Alt 2
89	57	43				V_{REFH}
90	58					V_{DDA}
91	—	—	PTK4			
92	—	—	PTK5			
93	—	—	PTK6			
94	—	—	PTK7			
95	59	44	PTA4	PIA4	ADP4	
96	60	45	PTB4	PIB4	ADP12	
97	61	—	PTC4		ADP20	
98	62	46	PTA5	PIA5	ADP5	
99	63	47	PTB5	PIB5	ADP13	
100	64	48	PTA6	PIA6	ADP6	

¹ Pin does not contain a clamp diode to V_{DD} and should not be driven above V_{DD} . The voltage measured on this pin when internal pull-up is enabled may be as low as $V_{DD} - 0.7V$. The internal gates connected to this pin are pulled to V_{DD} .

² The IIC1 module pins can be repositioned using IIC1PS bit in the SOPT1 register. The default reset locations are on PTF2 and PTF3.

³ The SCI2 module pins can be repositioned using SCI2PS bit in the SOPT1 register. The default reset locations are on PTF0 and PTF1.

⁴ If both these analog modules are enabled they both will have access to the pin.

Chapter 3

Modes of Operation

3.1 Introduction

The operating modes of the MC9S08DZ128 Series are described in this chapter. Entry into each mode, exit from each mode, and functionality while in each of the modes are described.

3.2 Features

- Active background mode for code development
- Wait mode — CPU shuts down to conserve power; system clocks are running and full regulation is maintained
- Stop modes — System clocks are stopped and voltage regulator is in standby
 - Stop3 — All internal circuits are powered for fast recovery
 - Stop2 — Partial power down of internal circuits; RAM content is retained

3.3 Run Mode

This is the normal operating mode for the MC9S08DZ128 Series. This mode is selected when the BKGD/MS pin is high at the rising edge of reset. In this mode, the CPU executes code from internal memory with execution beginning at the address fetched from memory at 0xFFFFE–0xFFFF after reset.

3.4 Active Background Mode

The active background mode functions are managed through the background debug controller (BDC) in the HCS08 core. The BDC, together with the on-chip debug module (DBG), provide the means for analyzing MCU operation during software development.

Active background mode is entered in any of five ways:

- When the BKGD/MS pin is low at the rising edge of reset
- When a BACKGROUND command is received through the BKGD/MS pin
- When a BGND instruction is executed
- When encountering a BDC breakpoint
- When encountering a DBG breakpoint

After entering active background mode, the CPU is held in a suspended state waiting for serial background commands rather than executing instructions from the user application program.

Background commands are of two types:

- Non-intrusive commands, defined as commands that can be issued while the user program is running. Non-intrusive commands can be issued through the BKGD/MS pin while the MCU is in run mode; non-intrusive commands can also be executed when the MCU is in the active background mode. Non-intrusive commands include:
 - Memory access commands
 - Memory-access-with-status commands
 - BDC register access commands
 - The BACKGROUND command
- Active background commands, which can only be executed while the MCU is in active background mode. Active background commands include commands to:
 - Read or write CPU registers
 - Trace one user program instruction at a time
 - Leave active background mode to return to the user application program (GO)

The active background mode is used to program a bootloader or user application program into the FLASH program memory before the MCU is operated in run mode for the first time. When the MC9S08DZ128 Series is shipped from the Freescale Semiconductor factory, the FLASH program memory is erased by default unless specifically noted so there is no program that could be executed in run mode until the FLASH memory is initially programmed. The active background mode can also be used to erase and reprogram the FLASH memory after it has been previously programmed.

For additional information about the active background mode, refer to the [Development Support](#) chapter.

3.5 Wait Mode

Wait mode is entered by executing a WAIT instruction. Upon execution of the WAIT instruction, the CPU enters a low-power state in which it is not clocked. The I bit in CCR is cleared when the CPU enters the wait mode, enabling interrupts. When an interrupt request occurs, the CPU exits the wait mode and resumes processing, beginning with the stacking operations leading to the interrupt service routine.

While the MCU is in wait mode, there are some restrictions on which background debug commands can be used. Only the BACKGROUND command and memory-access-with-status commands are available when the MCU is in wait mode. The memory-access-with-status commands do not allow memory access, but they report an error indicating that the MCU is in either stop or wait mode. The BACKGROUND command can be used to wake the MCU from wait mode and enter active background mode.

3.6 Stop Modes

One of two stop modes is entered upon execution of a STOP instruction when the STOPE bit in SOPT1 register is set. In both stop modes, all internal clocks are halted. The MCG module can be configured to leave the reference clocks running. See Chapter 8, “Multi-Purpose Clock Generator (S08MCGV2),” for more information.

Table 3-1 shows all of the control bits that affect stop mode selection and the mode selected under various conditions. The selected mode is entered following the execution of a STOP instruction.

Table 3-1. Stop Mode Selection

STOPE	ENBDM ¹	LVDE	LVDSE	PPDC	Stop Mode
0	x	x		x	Stop modes disabled; illegal opcode reset if STOP instruction executed
1	1	x		x	Stop3 with BDM enabled ²
1	0	Both bits must be 1		x ³	Stop3 with voltage regulator active
1	0	Either bit a 0		0	Stop3
1	0	Either bit a 0		1	Stop2

¹ ENBDM is located in the BDCSCR, which is only accessible through BDC commands, see the Development Support chapter.

² When in Stop3 mode with BDM enabled, The S_{IDD} will be near R_{IDD} levels because internal clocks are enabled.

³ If LVD = 1 in stop, the MCU enters stop3, regardless of the configuration of PPDC.

3.6.1 Stop3 Mode

Stop3 mode is entered by executing a STOP instruction under the conditions as shown in Table 3-1. The states of all of the internal registers and logic, RAM contents, and I/O pin states are maintained.

Exit from stop3 is done by asserting $\overline{\text{RESET}}$ or an asynchronous interrupt pin. The asynchronous interrupt pins are IRQ, PIA0–PIA7, PIB0–PIB7, PID0–PID7, and PIJ0–PIJ7. Exit from stop3 can also be done by the low voltage detection (LVD) reset, the low voltage warning (LVW) interrupt, the ADC conversion complete interrupt, the analog comparator interrupt, the real-time clock (RTC) interrupt, the MSCAN wake-up interrupt, or the SCI receiver interrupt.

If stop3 is exited by means of the $\overline{\text{RESET}}$ pin, the MCU will be reset and operation will resume after fetching the reset vector. Exit by means of an interrupt will result in the MCU fetching the appropriate interrupt vector.

3.6.1.1 LVD Enabled in Stop3 Mode

The LVD system is capable of generating either an interrupt or a reset when the supply voltage drops below the LVD voltage. If the LVD is enabled in stop (LVDE and LVDSE bits in SPMSC1 both set) at the time the CPU executes a STOP instruction, then the voltage regulator remains active during stop mode.

For the ADC to operate or for the ACMP to be used when comparing with an internal voltage, the LVD must be left enabled when entering stop3.

3.6.1.2 Active BDM Enabled in Stop3 Mode

Entry into the active background mode from run mode is enabled if ENBDM in BDCSCR is set. This register is described in [Chapter 17, “Development Support.”](#) If ENBDM is set when the CPU executes a STOP instruction, the system clocks to the background debug logic remain active when the MCU enters stop mode. Because of this, background debug communication remains possible. In addition, the voltage regulator does not enter its low-power standby state but maintains full internal regulation.

Most background commands are not available in stop mode. The memory-access-with-status commands do not allow memory access, but they report an error indicating that the MCU is in either stop or wait mode. The BACKGROUND command can be used to wake the MCU from stop and enter active background mode if the ENBDM bit is set. After entering background debug mode, all background commands are available.

3.6.2 Stop2 Mode

Stop2 mode is entered by executing a STOP instruction under the conditions as shown in [Table 3-1](#). Most of the internal circuitry of the MCU is powered off in stop2 with the exception of the RAM. Upon entering stop2, all I/O pin control signals are latched so that the pins retain their states during stop2.

Exit from stop2 is performed by asserting $\overline{\text{RESET}}$.

In addition, the real-time counter (RTC) can wake the MCU from stop2, if enabled.

Upon wake-up from stop2 mode, the MCU starts up as from a power-on reset (POR):

- All module control and status registers are reset
- The LVD reset function is enabled and the MCU remains in the reset state if V_{DD} is below the LVD trip point (low trip point selected due to POR)
- The CPU takes the reset vector

In addition to the above, upon waking up from stop2, the PPDF bit in SPMSC2 is set. This flag is used to direct user code to go to a stop2 recovery routine. PPDF remains set and the I/O pin states remain latched until a 1 is written to PPDACK in SPMSC2.

To maintain I/O states for pins that were configured as general-purpose I/O before entering stop2, the user must restore the contents of the I/O port registers, which have been saved in RAM, to the port registers before writing to the PPDACK bit. If the port registers are not restored from RAM before writing to PPDACK, then the pins will switch to their reset states when PPDACK is written.

For pins that were configured as peripheral I/O, the user must reconfigure the peripheral module that interfaces to the pin before writing to the PPDACK bit. If the peripheral module is not enabled before writing to PPDACK, the pins will be controlled by their associated port control registers when the I/O latches are opened.

3.6.3 On-Chip Peripheral Modules in Stop Modes

When the MCU enters any stop mode, system clocks to the internal peripheral modules are stopped. Even in the exception case ($\text{ENBDM} = 1$), where clocks to the background debug logic continue to operate,

clocks to the peripheral systems are halted to reduce power consumption. Refer to [Section 3.6.1, “Stop3 Mode”](#) and [Section 3.6.1, “Stop3 Mode”](#) for specific information on system behavior in stop modes.

Table 3-2. Stop Mode Behavior

Peripheral	Mode	
	Stop2	Stop3
CPU	Off	Standby
RAM	Standby	Standby
FLASH/EEPROM	Off	Standby
Parallel Port Registers	Off	Standby
ACMP	Off	Optionally On ¹
ADC	Off	Optionally On ²
IIC	Off	Standby
MCG	Off	Optionally On ³
MSCAN	Off	Standby
RTC	Optionally On ⁴	Optionally On ⁴
SCI	Off	Standby
SPI	Off	Standby
TPM	Off	Standby
Voltage Regulator	Optionally On ⁵	Optionally On ⁵
XOSC	Off	Optionally On ⁶
I/O Pins	States Held	States Held

¹ Requires the LVD to be enabled, else in standby.

² Requires the asynchronous ADC clock and LVD to be enabled, else in standby.

³ IRCLKEN and IREFSTEN set in MCGC1, else in standby.

⁴ Requires the RTC to be enabled, else in standby.

⁵ Requires the LVD or BDC to be enabled.

⁶ ERCLKEN and EREFSTEN set in MCGC2 for, else in standby. For high frequency range (RANGE in MCGC2 set) requires the LVD to also be enabled in stop3.

Chapter 4 Memory

4.1 MC9S08DZ128 Series Memory Map

On-chip memory in the MC9S08DZ128 Series consists of RAM, EEPROM, and FLASH program memory for nonvolatile data storage, and I/O and control/status registers. The registers are divided into three groups:

- Direct-page registers (0x0000 through 0x007F)
- High-page registers (0x1800 through 0x18FF)
- Nonvolatile registers (0xFFB0 through 0xFFBF)

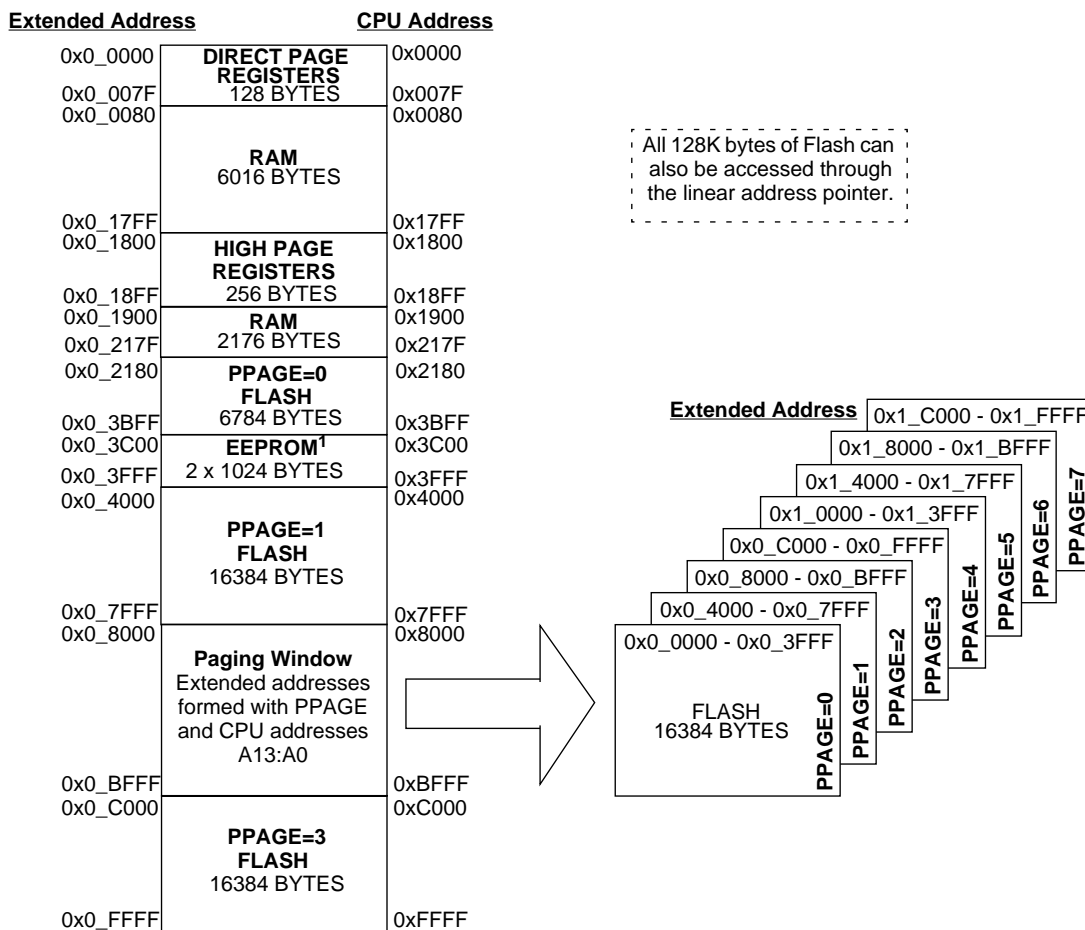

¹ EEPROM address range shows half the total EEPROM. See [Section 4.6.10, "EEPROM Mapping"](#) for more

Figure 4-1. MC9S08DZ128 Series Memory Map

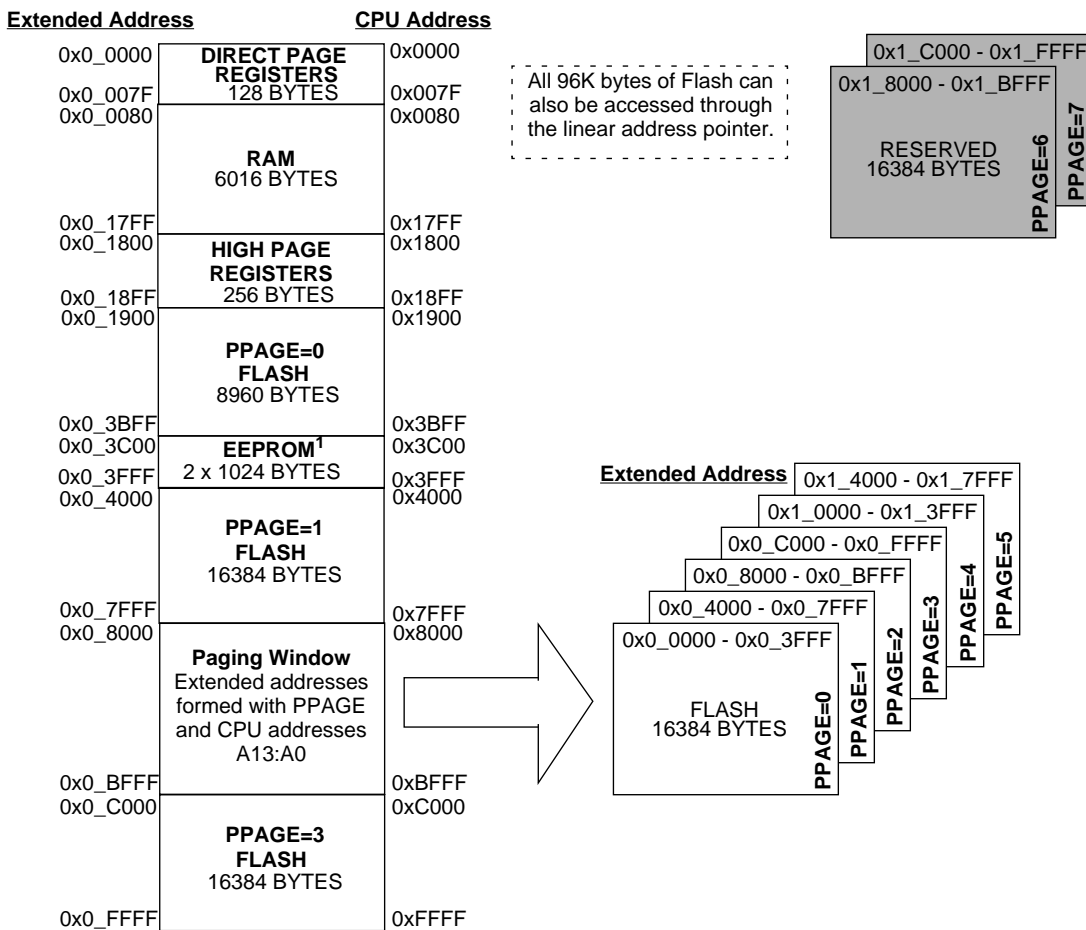

¹ EEPROM address range shows half the total EEPROM. See Section 4.6.10, "EEPROM Mapping" for more details.

Figure 4-2. MC9S08DZ96 Memory Map

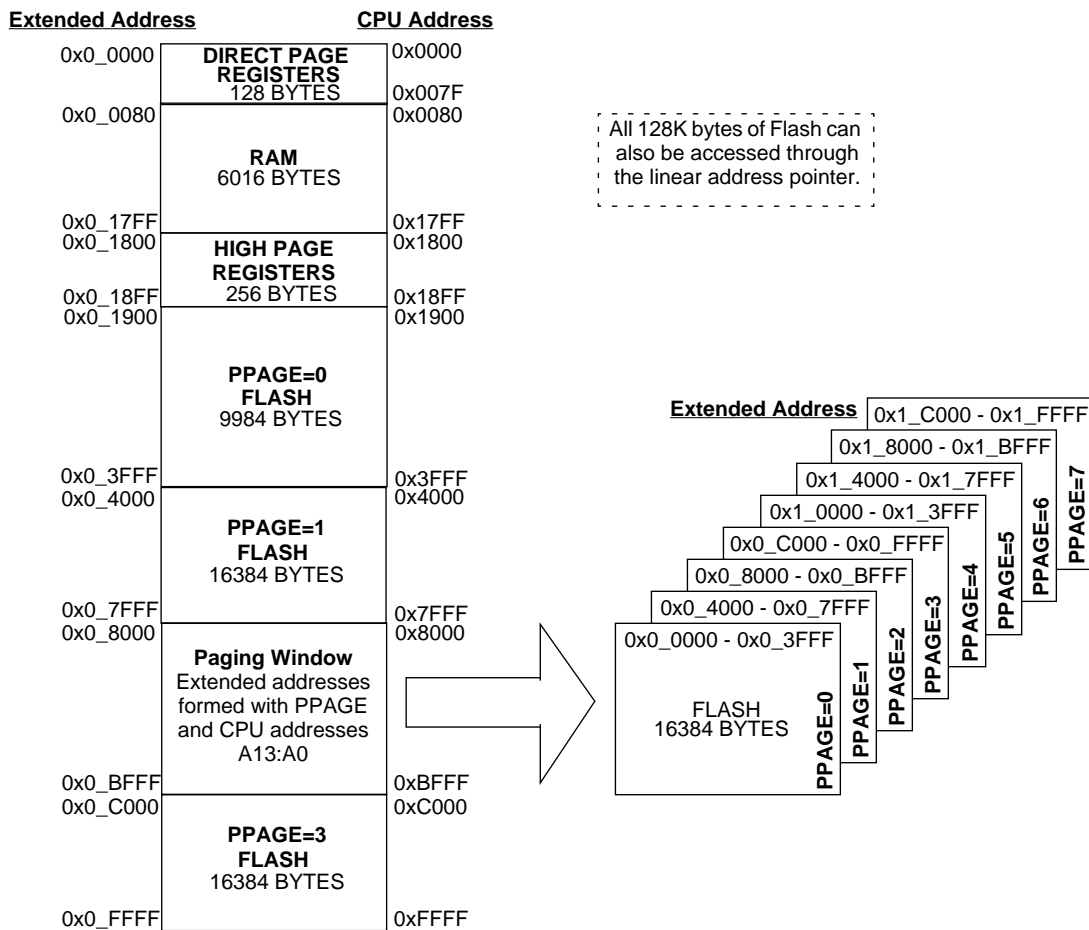

Figure 4-3. MC9S08DV128 Memory Map

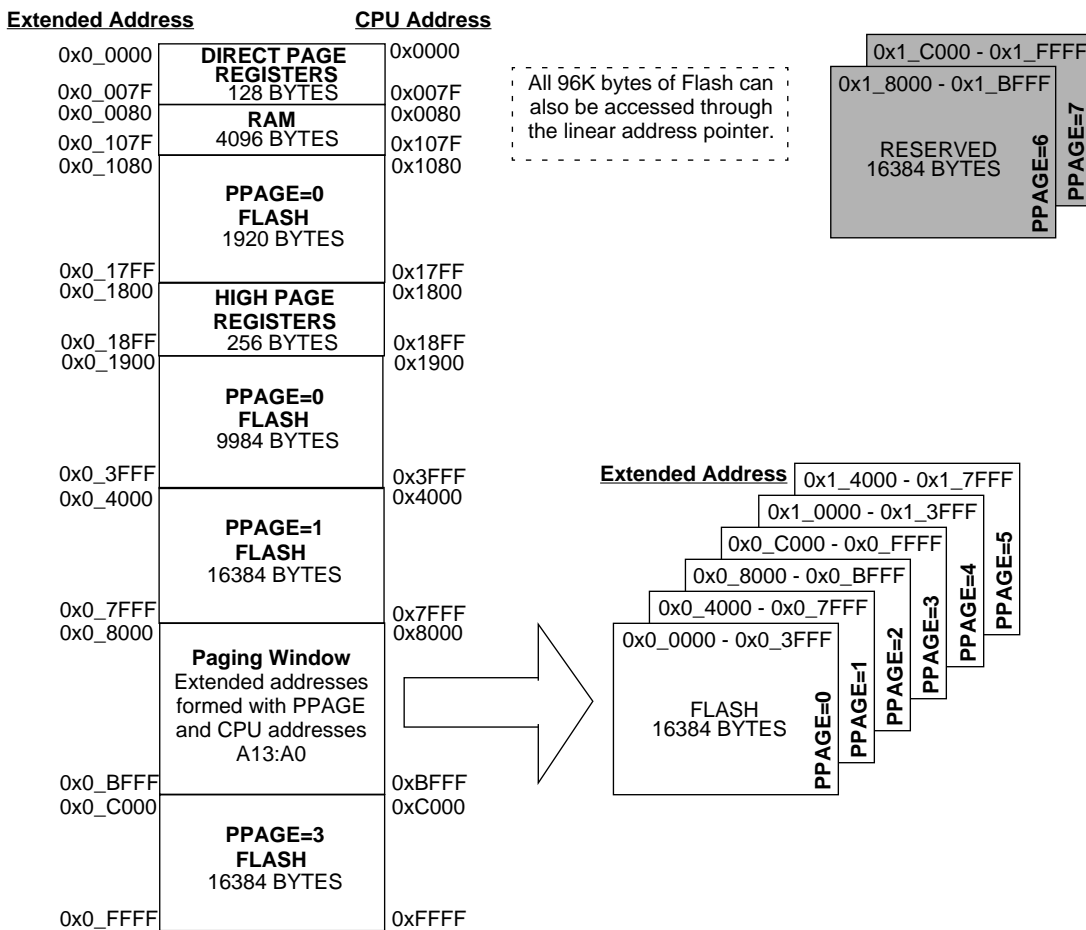

Figure 4-4. MC9S08DV96 Memory Map

4.2 Reset and Interrupt Vector Assignments

Table 4-1 shows address assignments for reset and interrupt vectors. The vector names shown in this table are the labels used in the MC9S08DZ128 Series equate file provided by Freescale Semiconductor.

Table 4-1. Reset and Interrupt Vectors

Address (High:Low)	Vector	Vector Name
0xFF80:0xFF81 - 0xFF8E:0xFF8F	Reserved	Reserved
0xFF90:0xFF91	Port J	Vportj
0xFF92:0xFF93	IIC2	Viic2
0xFF94:0xFF95	SPI2	Vspi2
0xFF96:0xFF97	TPM3 Overflow	Vtpm3ovf
0xFF98:0xFF99	TPM3 Channel 3	Vtpm3ch3
0xFF9A:0xFF9B	TPM3 Channel 2	Vtpm3ch2

Table 4-1. Reset and Interrupt Vectors (continued)

Address (High:Low)	Vector	Vector Name
0xFF9C:0xFF9D	TPM3 Channel 1	Vtpm3ch1
0xFF9E:0xFF9F	TPM3 Channel 0	Vtpm3ch0
0xFFA0:0xFFBF	Non-vector space	N/A
0xFFC0:0xFFC1	ACMP2	Vacmp2
0xFFC2:0xFFC3	ACMP1	Vacmp1
0xFFC4:0xFFC5	MSCAN Transmit	Vcantx
0xFFC6:0xFFC7	MSCAN Receive	Vcanrx
0xFFC8:0xFFC9	MSCAN errors	Vcanerr
0xFFCA:0xFFCB	MSCAN wake up	Vcanwu
0xFFCC:0xFFCD	RTC	Vrtc
0xFFCE:0xFFCF	IIC1	Viic1
0xFFD0:0xFFD1	ADC Conversion	Vadc
0xFFD2:0xFFD3	Port A, Port B, Port D	Vport
0xFFD4:0xFFD5	SCI2 Transmit	Vsci2tx
0xFFD6:0xFFD7	SCI2 Receive	Vsci2rx
0xFFD8:0xFFD9	SCI2 Error	Vsci2err
0xFFDA:0xFFDB	SCI1 Transmit	Vsci1tx
0xFFDC:0xFFDD	SCI1 Receive	Vsci1rx
0xFFDE:0xFFDF	SCI1 Error	Vsci1err
0xFFE0:0xFFE1	SPI1	Vspi1
0xFFE2:0xFFE3	TPM2 Overflow	Vtpm2ovf
0xFFE4:0xFFE5	TPM2 Channel 1	Vtpm2ch1
0xFFE6:0xFFE7	TPM2 Channel 0	Vtpm2ch0
0xFFE8:0xFFE9	TPM1 Overflow	Vtpm1ovf
0xFFEA:0xFFEB	TPM1 Channel 5	Vtpm1ch5
0xFFEC:0xFFED	TPM1 Channel 4	Vtpm1ch4
0xFFEE:0xFFEF	TPM1 Channel 3	Vtpm1ch3
0xFFFF0:0xFFFF1	TPM1 Channel 2	Vtpm1ch2
0xFFFF2:0xFFFF3	TPM1 Channel 1	Vtpm1ch1
0xFFFF4:0xFFFF5	TPM1 Channel 0	Vtpm1ch0
0xFFFF6:0xFFFF7	MCG Loss of lock	Vlol
0xFFFF8:0xFFFF9	Low-Voltage Detect	Vlvd
0xFFFFA:0xFFFFB	IRQ	Virq
0xFFFFC:0xFFFFD	SWI	Vswi
0xFFFFE:0xFFFFF	Reset	Vreset

4.3 Register Addresses and Bit Assignments

The registers in the MC9S08DZ128 Series are divided into these groups:

- Direct-page registers are located in the first 128 locations in the memory map; these are accessible with efficient direct addressing mode instructions.
- High-page registers are used much less often, so they are located above 0x1800 in the memory map. This leaves more room in the direct page for more frequently used registers and RAM.
- The nonvolatile register area consists of a block of 16 locations in FLASH memory at 0xFFB0–0xFFBF. Nonvolatile register locations include:
 - NVPROT and NVOPT are loaded into working registers at reset
 - An 8-byte backdoor comparison key that optionally allows a user to gain controlled access to secure memory

Because the nonvolatile register locations are FLASH memory, they must be erased and programmed like other FLASH memory locations.

Direct-page registers can be accessed with efficient direct addressing mode instructions. Bit manipulation instructions can be used to access any bit in any direct-page register. [Table 4-2](#) is a summary of all user-accessible direct-page registers and control bits.

The direct page registers in [Table 4-2](#) can use the more efficient direct addressing mode, which requires only the lower byte of the address. Because of this, the lower byte of the address in column one is shown in bold text. In [Table 4-3](#) and [Table 4-5](#), the whole address in column one is shown in bold. In [Table 4-2](#), [Table 4-3](#), and [Table 4-5](#), the register names in column two are shown in bold to set them apart from the bit names to the right. Cells that are not associated with named bits are shaded. A shaded cell with a 0 indicates this unused bit always reads as a 0. Shaded cells with dashes indicate unused or reserved bit locations that could read as 1s or 0s.

Table 4-2. Direct-Page Register Summary (Sheet 1 of 4)

Address	Register Name	Bit 7	6	5	4	3	2	1	Bit 0
0x0000	PTAD	PTAD7	PTAD6	PTAD5	PTAD4	PTAD3	PTAD2	PTAD1	PTAD0
0x0001	PTADD	PTADD7	PTADD6	PTADD5	PTADD4	PTADD3	PTADD2	PTADD1	PTADD0
0x0002	PTBD	PTBD7	PTBD6	PTBD5	PTBD4	PTBD3	PTBD2	PTBD1	PTBD0
0x0003	PTBDD	PTBDD7	PTBDD6	PTBDD5	PTBDD4	PTBDD3	PTBDD2	PTBDD1	PTBDD0
0x0004	PTCD	PTCD7	PTCD6	PTCD5	PTCD4	PTCD3	PTCD2	PTCD1	PTCD0
0x0005	PTCDD	PTCDD7	PTCDD6	PTCDD5	PTCDD4	PTCDD3	PTCDD2	PTCDD1	PTCDD0
0x0006	PTDD	PTDD7	PTDD6	PTDD5	PTDD4	PTDD3	PTDD2	PTDD1	PTDD0
0x0007	PTDDD	PTDDD7	PTDDD6	PTDDD5	PTDDD4	PTDDD3	PTDDD2	PTDDD1	PTDDD0
0x0008	PTED	PTED7	PTED6	PTED5	PTED4	PTED3	PTED2	PTED1	PTED0
0x0009	PTEDD	PTEDD7	PTEDD6	PTEDD5	PTEDD4	PTEDD3	PTEDD2	PTEDD1	PTEDD0
0x000A	PTFD	PTFD7	PTFD6	PTFD5	PTFD4	PTFD3	PTFD2	PTFD1	PTFD0
0x000B	PTFDD	PTFDD7	PTFDD6	PTFDD5	PTFDD4	PTFDD3	PTFDD2	PTFDD1	PTFDD0
0x000C	PTGD	PTGD7	PTGD6	PTGD5	PTGD4	PTGD3	PTGD2	PTGD1	PTGD0
0x000D	PTGDD	PTGDD7	PTGDD6	PTGDD5	PTGDD4	PTGDD3	PTGDD2	PTGDD1	PTGDD0
0x000E	ACMP1SC	ACME	ACBGS	ACF	ACIE	ACO	ACOPE	ACMOD1	ACMOD0
0x000F	ACMP2SC	ACME	ACBGS	ACF	ACIE	ACO	ACOPE	ACMOD1	ACMOD0
0x0010	ADCSC1	COCO	AIEN	ADCO	ADCH				
0x0011	ADCSC2	ADACT	ADTRG	ACFE	ACFGT	0	0	Reserved	Reserved
0x0012	ADCRH	0	0	0	0	ADR11	ADR10	ADR9	ADR8
0x0013	ADCRL	ADR7	ADR6	ADR5	ADR4	ADR3	ADR2	ADR1	ADR0
0x0014	ADCCVH	0	0	0	0	ADC11	ADC10	ADCV9	ADCV8
0x0015	ADCCVL	ADCV7	ADCV6	ADCV5	ADCV4	ADCV3	ADCV2	ADCV1	ADCV0
0x0016	ADCCFG	ADLPC	ADIV		ADLSMP	MODE		ADICLK	
0x0017	APCTL1	ADPC7	ADPC6	ADPC5	ADPC4	ADPC3	ADPC2	ADPC1	ADPC0
0x0018	APCTL2	ADPC15	ADPC14	ADPC13	ADPC12	ADPC11	ADPC10	ADPC9	ADPC8
0x0019	APCTL3	ADPC23	ADPC22	ADPC21	ADPC20	ADPC19	ADPC18	ADPC17	ADPC16
0x001A– 0x001B	Reserved	—	—	—	—	—	—	—	—
0x001C	IRQSC	0	IRQPDD	IRQEDG	IRQPE	IRQF	IRQACK	IRQIE	IRQMOD
0x001D– 0x001F	Reserved	—	—	—	—	—	—	—	—
0x0020	TPM1SC	TOF	TOIE	CPWMS	CLKSB	CLKSA	PS2	PS1	PS0
0x0021	TPM1CNTH	Bit 15	14	13	12	11	10	9	Bit 8
0x0022	TPM1CNTL	Bit 7	6	5	4	3	2	1	Bit 0
0x0023	TPM1MODH	Bit 15	14	13	12	11	10	9	Bit 8
0x0024	TPM1MODL	Bit 7	6	5	4	3	2	1	Bit 0
0x0025	TPM1C0SC	CH0F	CH0IE	MS0B	MS0A	ELS0B	ELS0A	0	0
0x0026	TPM1C0VH	Bit 15	14	13	12	11	10	9	Bit 8
0x0027	TPM1C0VL	Bit 7	6	5	4	3	2	1	Bit 0

Table 4-2. Direct-Page Register Summary (Sheet 2 of 4)

Address	Register Name	Bit 7	6	5	4	3	2	1	Bit 0
0x0028	TPM1C1SC	CH1F	CH1IE	MS1B	MS1A	ELS1B	ELS1A	0	0
0x0029	TPM1C1VH	Bit 15	14	13	12	11	10	9	Bit 8
0x002A	TPM1C1VL	Bit 7	6	5	4	3	2	1	Bit 0
0x002B	TPM1C2SC	CH2F	CH2IE	MS2B	MS2A	ELS2B	ELS2A	0	0
0x002C	TPM1C2VH	Bit 15	14	13	12	11	10	9	Bit 8
0x002D	TPM1C2VL	Bit 7	6	5	4	3	2	1	Bit 0
0x002E	TPM1C3SC	CH3F	CH3IE	MS3B	MS3A	ELS3B	ELS3A	0	0
0x002F	TPM1C3VH	Bit 15	14	13	12	11	10	9	Bit 8
0x0030	TPM1C3VL	Bit 7	6	5	4	3	2	1	Bit 0
0x0031	TPM1C4SC	CH4F	CH4IE	MS4B	MS4A	ELS4B	ELS4A	0	0
0x0032	TPM1C4VH	Bit 15	14	13	12	11	10	9	Bit 8
0x0033	TPM1C4VL	Bit 7	6	5	4	3	2	1	Bit 0
0x0034	TPM1C5SC	CH5F	CH5IE	MS5B	MS5A	ELS5B	ELS5A	0	0
0x0035	TPM1C5VH	Bit 15	14	13	12	11	10	9	Bit 8
0x0036	TPM1C5VL	Bit 7	6	5	4	3	2	1	Bit 0
0x0037	Reserved	—	—	—	—	—	—	—	—
0x0038	SCI1BDH	LBKDIE	RXEDGIE	0	SBR12	SBR11	SBR10	SBR9	SBR8
0x0039	SCI1BDL	SBR7	SBR6	SBR5	SBR4	SBR3	SBR2	SBR1	SBR0
0x003A	SCI1C1	LOOPS	SCISWAI	RSRC	M	WAKE	ILT	PE	PT
0x003B	SCI1C2	TIE	TCIE	RIE	ILIE	TE	RE	RWU	SBK
0x003C	SCI1S1	TDRE	TC	RDRF	IDLE	OR	NF	FE	PF
0x003D	SCI1S2	LBKDIF	RXEDGIF	0	RXINV	RWUID	BRK13	LBKDE	RAF
0x003E	SCI1C3	R8	T8	TXDIR	TXINV	ORIE	NEIE	FEIE	PEIE
0x003F	SCI1D	Bit 7	6	5	4	3	2	1	Bit 0
0x0040	SCI2BDH	LBKDIE	RXEDGIE	0	SBR12	SBR11	SBR10	SBR9	SBR8
0x0041	SCI2BDL	SBR7	SBR6	SBR5	SBR4	SBR3	SBR2	SBR1	SBR0
0x0042	SCI2C1	LOOPS	SCISWAI	RSRC	M	WAKE	ILT	PE	PT
0x0043	SCI2C2	TIE	TCIE	RIE	ILIE	TE	RE	RWU	SBK
0x0044	SCI2S1	TDRE	TC	RDRF	IDLE	OR	NF	FE	PF
0x0045	SCI2S2	LBKDIF	RXEDGIF	0	RXINV	RWUID	BRK13	LBKDE	RAF
0x0046	SCI2C3	R8	T8	TXDIR	TXINV	ORIE	NEIE	FEIE	PEIE
0x0047	SCI2D	Bit 7	6	5	4	3	2	1	Bit 0
0x0048	MCGC1	CLKS		RDIV			IREFS	IRCLKEN	IREFSTEN
0x0049	MCGC2	BDIV		RANGE	HGO	LP	EREFS	ERCLKEN	EREFSTEN
0x004A	MCGTRM	TRIM							
0x004B	MCGSC	LOLS	LOCK	PLLST	IREFST	CLKST		OSCINIT	FTRIM
0x004C	MCGC3	LOLIE	PLLS	CME	DIV32	VDIV			
0x004D	MCGT	0	0	DMX32	0	0	0	0	DRS

Table 4-2. Direct-Page Register Summary (Sheet 3 of 4)

Address	Register Name	Bit 7	6	5	4	3	2	1	Bit 0
0x004E– 0x004F	Reserved	—	—	—	—	—	—	—	—
0x0050	SPI1C1	SPIE	SPE	SPTIE	MSTR	CPOL	CPHA	SSOE	LSBFE
0x0051	SPI1C2	0	0	0	MODFEN	BIDIROE	0	SPISWAI	SPC0
0x0052	SPI1BR	0	SPPR2	SPPR1	SPPR0	0	SPR2	SPR1	SPR0
0x0053	SPI1S	SPRF	0	SPTEF	MODF	0	0	0	0
0x0054	Reserved	0	0	0	0	0	0	0	0
0x0055	SPI1D	Bit 7	6	5	4	3	2	1	Bit 0
0x0056– 0x0057	Reserved	—	—	—	—	—	—	—	—
0x0058	IIC1A	AD7	AD6	AD5	AD4	AD3	AD2	AD1	0
0x0059	IIC1F	MULT			ICR				
0x005A	IIC1C1	IICEN	IICIE	MST	TX	TXAK	RSTA	0	0
0x005B	IIC1S	TCF	IAAS	BUSY	ARBL	0	SRW	IICIF	RXAK
0x005C	IIC1D	DATA							
0x005D	IIC1C2	GCAEN	ADEXT	0	0	0	AD10	AD9	AD8
0x005E– 0x005F	Reserved	—	—	—	—	—	—	—	—
0x0060	TPM2SC	TOF	TOIE	CPWMS	CLKSB	CLKSA	PS2	PS1	PS0
0x0061	TPM2CNTH	Bit 15	14	13	12	11	10	9	Bit 8
0x0062	TPM2CNTL	Bit 7	6	5	4	3	2	1	Bit 0
0x0063	TPM2MODH	Bit 15	14	13	12	11	10	9	Bit 8
0x0064	TPM2MODL	Bit 7	6	5	4	3	2	1	Bit 0
0x0065	TPM2C0SC	CH0F	CH0IE	MS0B	MS0A	ELS0B	ELS0A	0	0
0x0066	TPM2C0VH	Bit 15	14	13	12	11	10	9	Bit 8
0x0067	TPM2C0VL	Bit 7	6	5	4	3	2	1	Bit 0
0x0068	TPM2C1SC	CH1F	CH1IE	MS1B	MS1A	ELS1B	ELS1A	0	0
0x0069	TPM2C1VH	Bit 15	14	13	12	11	10	9	Bit 8
0x006A	TPM2C1VL	Bit 7	6	5	4	3	2	1	Bit 0
0x006B	Reserved	—	—	—	—	—	—	—	—
0x006C	RTCSC	RTIF	RTCLKS		RTIE	RTCPS			
0x006D	RTCCNT	RTCCNT							
0x006E	RTCMOD	RTCMOD							
0x006F	Reserved	—	—	—	—	—	—	—	—
0x0070	PTHDD	PTHDD7	PTHDD6	PTHDD5	PTHDD4	PTHDD3	PTHDD2	PTHDD1	PTHDD0
0x0071	PTJDD	PTJDD7	PTJDD6	PTJDD5	PTJDD4	PTJDD3	PTJDD2	PTJDD1	PTJDD0
0x0072	PTJDD	PTJD7	PTJD6	PTJD5	PTJD4	PTJD3	PTJD2	PTJD1	PTJD0
0x0073	PTJDD	PTJDD7	PTJDD6	PTJDD5	PTJDD4	PTJDD3	PTJDD2	PTJDD1	PTJDD0
0x0074	PTKDD	PTKD7	PTKD6	PTKD5	PTKD4	PTKD3	PTKD2	PTKD1	PTKD0

Table 4-2. Direct-Page Register Summary (Sheet 4 of 4)

Address	Register Name	Bit 7	6	5	4	3	2	1	Bit 0
0x0075	PTKDD	PTKDD7	PTKDD6	PTKDD5	PTKDD4	PTKDD3	PTKDD2	PTKDD1	PTKDD0
0x0076	PTLD	PTLD7	PTLD6	PTLD5	PTLD4	PTLD3	PTLD2	PTLD1	PTLD0
0x0077	PTLDD	PTLDD7	PTLDD6	PTLDD5	PTLDD4	PTLDD3	PTLDD2	PTLDD1	PTLDD0
0x0078	PPAGE	0	0	0	0	0	XA16	XA15	XA14
0x0079	LAP2	0	0	0	0	0	0	0	LA16
0x007A	LAP1	LA15	LA14	LA13	LA12	LA11	LA10	LA9	LA8
0x007B	LAP0	LA7	LA6	LA5	LA4	LA3	LA2	LA1	LA0
0x007C	LWP	D7	D6	D5	D4	D3	D2	D1	D0
0x007D	LBP	D7	D6	D5	D4	D3	D2	D1	D0
0x007E	LB	D7	D6	D5	D4	D3	D2	D1	D0
0x007F	LAPAB	D7	D6	D5	D4	D3	D2	D1	D0

High-page registers, shown in Table 4-3, are accessed much less often than other I/O and control registers so they have been located outside the direct addressable memory space, starting at 0x1800.

Table 4-3. High-Page Register Summary (Sheet 1 of 5)

Address	Register Name	Bit 7	6	5	4	3	2	1	Bit 0
0x1800	SRS	POR	PIN	COP	ILOP	ILAD	LOC	LVD	0
0x1801	SBDFR	0	0	0	0	0	0	0	BDFR
0x1802	SOPT1	COPT		STOPE	SCI2PS	IIC1PS	0	0	0
0x1803	SOPT2	COPCLKS	COPW	0	ADHTS	0	MCSEL		
0x1804 – 0x1805	Reserved	—	—	—	—	—	—	—	—
0x1806	SDIDH	—	—	—	—	ID11	ID10	ID9	ID8
0x1807	SDIDL	ID7	ID6	ID5	ID4	ID3	ID2	ID1	ID0
0x1808	Reserved	—	—	—	—	—	—	—	—
0x1809	SPMSC1	LVWF	LVWACK	LVWIE	LVDRE	LVDSE	LVDE	0	BGBE
0x180A	SPMSC2	0	0	LVDV	LVWV	PPDF	PPDACK	—	PPDC
0x180B – 0x180F	Reserved	—	—	—	—	—	—	—	—
0x1810	DBGCAH	Bit 15	14	13	12	11	10	9	Bit 8
0x1811	DBGCAL	Bit 7	6	5	4	3	2	1	Bit 0
0x1812	DBGCBH	Bit 15	14	13	12	11	10	9	Bit 8
0x1813	DBGCBL	Bit 7	6	5	4	3	2	1	Bit 0
0x1814	DBGCCH	Bit 15	14	13	12	11	10	9	Bit 8
0x1815	DBGCCL	Bit 7	6	5	4	3	2	1	Bit 0
0x1816	DBGFH	Bit 15	14	13	12	11	10	9	Bit 8
0x1817	DBGFL	Bit 7	6	5	4	3	2	1	Bit 0
0x1818	DBGCAH	RWAEN	RWA	PAGSEL	0	0	0	0	Bit 16
0x1819	DBGCBX	RWBEN	RWB	PAGSEL	0	0	0	0	Bit 16

Table 4-3. High-Page Register Summary (Sheet 2 of 5)

Address	Register Name	Bit 7	6	5	4	3	2	1	Bit 0	
0x181A	DBGCCX	RWCEN	RWC	PAGSEL	0	0	0	0	Bit 16	
0x181B	DBGFX	PPACC	0	0	0	0	0	0	Bit 16	
0x181C	DBGC	DBGEN	ARM	TAG	BRKEN	0	0	0	LOOP1	
0x181D	DBGT	TRGSEL	BEGIN	0	0	TRG				
0x181E	DBGS	AF	BF	CF	0	0	0	0	ARMF	
0x181F	DBGCNT	0	0	0	0	CNT				
0x1820	FCDIV	DIVLD	PRDIV8	DIV						
0x1821	FOPT	KEYEN	FNORED	EPGMOD	0	0	0	SEC		
0x1822	Reserved	—	—	—	—	—	—	—	—	
0x1823	FCNFG	0	EPGSEL	KEYACC	1	0	0	0	1	
0x1824	FPROT	EPS		FPS				FPOP		
0x1825	FSTAT	FCBEF	FCCF	FPVIOL	FACCERR	0	FBLANK	0	0	
0x1826	FCMD	FCMD								
0x1827– 0x182F	Reserved	—	—	—	—	—	—	—	—	
0x1830	SPI2C1	SPIE	SPE	SPTIE	MSTR	CPOL	CPHA	SSOE	LSBFE	
0x1831	SPI2C2	0	0	0	MODFEN	BIDIROE	0	SPISWAI	SPC0	
0x1832	SPI2BR	0	SPPR2	SPPR1	SPPR0	0	SPR2	SPR1	SPR0	
0x1833	SPI2S	SPRF	0	SPTEF	MODF	0	0	0	0	
0x1834	Reserved	0	0	0	0	0	0	0	0	
0x1835	SPI2D	Bit 7	6	5	4	3	2	1	Bit 0	
0x1836– 0x1837	Reserved	—	—	—	—	—	—	—	—	
0x1838	PTKPE	PTKPE7	PTKPE6	PTKPE5	PTKPE4	PTKPE3	PTKPE2	PTKPE1	PTKPE0	
0x1839	PTKSE	PTKSE7	PTKSE6	PTKSE5	PTKSE4	PTKSE3	PTKSE2	PTKSE1	PTKSE0	
0x183A	PTKDS	PTKDS7	PTKDS6	PTKDS5	PTKDS4	PTKDS3	PTKDS2	PTKDS1	PTKDS0	
0x183B	Reserved	—	—	—	—	—	—	—	—	
0x183C	PTLPE	PTLPE7	PTLPE6	PTLPE5	PTLPE4	PTLPE3	PTLPE2	PTLPE1	PTLPE0	
0x183D	PTLSE	PTLSE7	PTLSE6	PTLSE5	PTLSE4	PTLSE3	PTLSE2	PTLSE1	PTLSE0	
0x183E	PTLDS	PTLDS7	PTLDS6	PTLDS5	PTLDS4	PTLDS3	PTLDS2	PTLDS1	PTLDS0	
0x183F	Reserved	—	—	—	—	—	—	—	—	
0x1840	PTAPE	PTAPE7	PTAPE6	PTAPE5	PTAPE4	PTAPE3	PTAPE2	PTAPE1	PTAPE0	
0x1841	PTASE	PTASE7	PTASE6	PTASE5	PTASE4	PTASE3	PTASE2	PTASE1	PTASE0	
0x1842	PTADS	PTADS7	PTADS6	PTADS5	PTADS4	PTADS3	PTADS2	PTADS1	PTADS0	
0x1843	Reserved	—	—	—	—	—	—	—	—	
0x1844	PTASC	0	0	0	0	PTAIF	PTAACK	PTAIE	PTAMOD	
0x1845	PTAPS	PTAPS7	PTAPS6	PTAPS5	PTAPS4	PTAPS3	PTAPS2	PTAPS1	PTAPS0	
0x1846	PTAES	PTAES7	PTAES6	PTAES5	PTAES4	PTAES3	PTAES2	PTAES1	PTAES0	
0x1847	Reserved	—	—	—	—	—	—	—	—	
0x1848	PTBPE	PTBPE7	PTBPE6	PTBPE5	PTBPE4	PTBPE3	PTBPE2	PTBPE1	PTBPE0	

Table 4-3. High-Page Register Summary (Sheet 3 of 5)

Address	Register Name	Bit 7	6	5	4	3	2	1	Bit 0
0x1849	PTBSE	PTBSE7	PTBSE6	PTBSE5	PTBSE4	PTBSE3	PTBSE2	PTBSE1	PTBSE0
0x184A	PTBDS	PTBDS7	PTBDS6	PTBDS5	PTBDS4	PTBDS3	PTBDS2	PTBDS1	PTBDS0
0x184B	Reserved	—	—	—	—	—	—	—	—
0x184C	PTBSC	0	0	0	0	PTBIF	PTBACK	PTBIE	PTBMOD
0x184D	PTBPS	PTBPS7	PTBPS6	PTBPS5	PTBPS4	PTBPS3	PTBPS2	PTBPS1	PTBPS0
0x184E	PTBES	PTBES7	PTBES6	PTBES5	PTBES4	PTBES3	PTBES2	PTBES1	PTBES0
0x184F	Reserved	—	—	—	—	—	—	—	—
0x1850	PTCPE	PTCPE7	PTCPE6	PTCPE5	PTCPE4	PTCPE3	PTCPE2	PTCPE1	PTCPE0
0x1851	PTCSE	PTCSE7	PTCSE6	PTCSE5	PTCSE4	PTCSE3	PTCSE2	PTCSE1	PTCSE0
0x1852	PTCDS	PTCDS7	PTCDS6	PTCDS5	PTCDS4	PTCDS3	PTCDS2	PTCDS1	PTCDS0
0x1853– 0x1857	Reserved	—	—	—	—	—	—	—	—
0x1858	PTDPE	PTDPE7	PTDPE6	PTDPE5	PTDPE4	PTDPE3	PTDPE2	PTDPE1	PTDPE0
0x1859	PTDSE	PTDSE7	PTDSE6	PTDSE5	PTDSE4	PTDSE3	PTDSE2	PTDSE1	PTDSE0
0x185A	PTDDS	PTDDS7	PTDDS6	PTDDS5	PTDDS4	PTDDS3	PTDDS2	PTDDS1	PTDDS0
0x185B	Reserved	—	—	—	—	—	—	—	—
0x185C	PTDSC	0	0	0	0	PTDIF	PTDACK	PTDIE	PTDMOD
0x185D	PTDPS	PTDPS7	PTDPS6	PTDPS5	PTDPS4	PTDPS3	PTDPS2	PTDPS1	PTDPS0
0x185E	PTDES	PTDES7	PTDES6	PTDES5	PTDES4	PTDES3	PTDES2	PTDES1	PTDES0
0x185F	Reserved	—	—	—	—	—	—	—	—
0x1860	PTEPE	PTEPE7	PTEPE6	PTEPE5	PTEPE4	PTEPE3	PTEPE2	PTEPE1	PTEPE0
0x1861	PTESE	PTESE7	PTESE6	PTESE5	PTESE4	PTESE3	PTESE2	PTESE1	PTESE0
0x1862	PTEDS	PTEDS7	PTEDS6	PTEDS5	PTEDS4	PTEDS3	PTEDS2	PTEDS1	PTEDS0
0x1863– 0x1867	Reserved	—	—	—	—	—	—	—	—
0x1868	PTFPE	PTFPE7	PTFPE6	PTFPE5	PTFPE4	PTFPE3	PTFPE2	PTFPE1	PTFPE0
0x1869	PTFSE	PTFSE7	PTFSE6	PTFSE5	PTFSE4	PTFSE3	PTFSE2	PTFSE1	PTFSE0
0x186A	PTFDS	PTFDS7	PTFDS6	PTFDS5	PTFDS4	PTFDS3	PTFDS2	PTFDS1	PTFDS0
0x186B– 0x186F	Reserved	—	—	—	—	—	—	—	—
0x1870	PTGPE	PTGPE7	PTGPE6	PTGPE5	PTGPE4	PTGPE3	PTGPE2	PTGPE1	PTGPE0
0x1871	PTGSE	PTGSE7	PTGSE6	PTGSE5	PTGSE4	PTGSE3	PTGSE2	PTGSE1	PTGSE0
0x1872	PTGDS	PTGDS7	PTGDS6	PTGDS5	PTGDS4	PTGDS3	PTGDS2	PTGDS1	PTGDS0
0x1873	Reserved	—	—	—	—	—	—	—	—
0x1874	PTHPE	PTHPE7	PTHPE6	PTHPE5	PTHPE4	PTHPE3	PTHPE2	PTHPE1	PTHPE0
0x1875	PTHSE	PTHSE7	PTHSE6	PTHSE5	PTHSE4	PTHSE3	PTHSE2	PTHSE1	PTHSE0
0x1876	PTHDS	PTHDS7	PTHDS6	PTHDS5	PTHDS4	PTHDS3	PTHDS2	PTHDS1	PTHDS0
0x1877	Reserved	—	—	—	—	—	—	—	—
0x1878	PTJPE	PTJPE7	PTJPE6	PTJPE5	PTJPE4	PTJPE3	PTJPE2	PTJPE1	PTJPE0
0x1879	PTJSE	PTJSE7	PTJSE6	PTJSE5	PTJSE4	PTJSE3	PTJSE2	PTJSE1	PTJSE0

Table 4-3. High-Page Register Summary (Sheet 4 of 5)

Address	Register Name	Bit 7	6	5	4	3	2	1	Bit 0
0x187A	PTJDS	PTJDS7	PTJDS6	PTJDS5	PTJDS4	PTJDS3	PTJDS2	PTJDS1	PTJDS0
0x187B	Reserved	—	—	—	—	—	—	—	—
0x187C	PTJSC	0	0	0	0	PTJIF	PTJACK	PTJIE	PTJMOD
0x187D	PTJPS	PTJPS7	PTJPS6	PTJPS5	PTJPS4	PTJPS3	PTJPS2	PTJPS1	PTJPS0
0x187E	PTJES	PTJES7	PTJES6	PTJES5	PTJES4	PTJES3	PTJES2	PTJES1	PTJES0
0x187F	Reserved	—	—	—	—	—	—	—	—
0x1880	CANCTL0	RXFRM	RXACT	CSWAI	SYNCH	TIME	WUPE	SLPRQ	INITRQ
0x1881	CANCTL1	CANE	CLKSRC	LOOPB	LISTEN	BORM	WUPM	SLPAK	INITAK
0x1882	CANBTR0	SJW1	SJW0	BRP5	BRP4	BRP3	BRP2	BRP1	BRP0
0x1883	CANBTR1	SAMP	TSEG22	TSEG21	TSEG20	TSEG13	TSEG12	TSEG11	TSEG10
0x1884	CANRFLG	WUPIF	CSCIF	RSTAT1	RSTAT0	TSTAT1	TSTAT0	OVRIF	RXF
0x1885	CANRIER	WUPIE	CSCIE	RSTATE1	RSTATE0	TSTATE1	TSTATE0	OVRIE	RXFIE
0x1886	CANTFLG	0	0	0	0	0	TXE2	TXE1	TXE0
0x1887	CANTIER	0	0	0	0	0	TXEIE2	TXEIE1	TXEIE0
0x1888	CANTARQ	0	0	0	0	0	ABTRQ2	ABTRQ1	ABTRQ0
0x1889	CANTAACK	0	0	0	0	0	ABTAK2	ABTAK1	ABTAK0
0x188A	CANTBSEL	0	0	0	0	0	TX2	TX1	TX0
0x188B	CANIDAC	0	0	IDAM1	IDAM0	0	IDHIT2	IDHIT1	IDHIT0
0x188C	Reserved	0	0	0	0	0	0	0	0
0x188D	CANMISC	0	0	0	0	0	0	0	BOHOLD
0x188E	CANRXERR	RXERR7	RXERR6	RXERR5	RXERR4	RXERR3	RXERR2	RXERR1	RXERR0
0x188F	CANTXERR	TXERR7	TXERR6	TXERR5	TXERR4	TXERR3	TXERR2	TXERR1	TXERR0
0x1890 – 0x1893	CANIDAR0 – CANIDAR3	AC7	AC6	AC5	AC4	AC3	AC2	AC1	AC0
0x1894 – 0x1897	CANIDMR0 – CANIDMR3	AM7	AM6	AM5	AM4	AM3	AM2	AM1	AM0
0x1898 – 0x189B	CANIDAR4 – CANIDAR7	AC7	AC6	AC5	AC4	AC3	AC2	AC1	AC0
0x189C – 0x189F	CANIDMR4 – CANIDMR7	AM7	AM6	AM5	AM4	AM3	AM2	AM1	AM0
0x18A0 – 0x18AF	MSCAN Rx Buffer	See Table 4-4 for an example extended mapping buffer layout. For complete details, see the MSCAN chapter.							
0x18B0 – 0x18BF	MSCAN Tx Buffer	See Table 4-4 for an example extended mapping buffer layout. For complete details, see the MSCAN chapter.							
0x18C0	TPM3SC	TOF	TOIE	CPWMS	CLKSB	CLKSA	PS2	PS1	PS0
0x18C1	TPM3CNTH	Bit 15	14	13	12	11	10	9	Bit 8
0x18C2	TPM3CNTL	Bit 7	6	5	4	3	2	1	Bit 0
0x18C3	TPM3MODH	Bit 15	14	13	12	11	10	9	Bit 8
0x18C4	TPM3MODL	Bit 7	6	5	4	3	2	1	Bit 0
0x18C5	TPM3C0SC	CH0F	CH0IE	MS0B	MS0A	ELS0B	ELS0A	0	0
0x18C6	TPM3C0VH	Bit 15	14	13	12	11	10	9	Bit 8

Table 4-3. High-Page Register Summary (Sheet 5 of 5)

Address	Register Name	Bit 7	6	5	4	3	2	1	Bit 0
0x18C7	TPM3C0VL	Bit 7	6	5	4	3	2	1	Bit 0
0x18C8	TPM3C1SC	CH1F	CH1IE	MS1B	MS1A	ELS1B	ELS1A	0	0
0x18C9	TPM3C1VH	Bit 15	14	13	12	11	10	9	Bit 8
0x18CA	TPM3C1VL	Bit 7	6	5	4	3	2	1	Bit 0
0x18CB	TPM3C2SC	CH2F	CH2IE	MS2B	MS2A	ELS2B	ELS2A	0	0
0x18CC	TPM3C2VH	Bit 15	14	13	12	11	10	9	Bit 8
0x18CD	TPM3C2VL	Bit 7	6	5	4	3	2	1	Bit 0
0x18CE	TPM3C3SC	CH3F	CH3IE	MS3B	MS3A	ELS3B	ELS3A	0	0
0x18CF	TPM3C3VH	Bit 15	14	13	12	11	10	9	Bit 8
0x18D0	TPM3C3VL	Bit 7	6	5	4	3	2	1	Bit 0
0x18D1– 0x18D7	Reserved	—	—	—	—	—	—	—	—
0x18D8	IIC2A	AD7	AD6	AD5	AD4	AD3	AD2	AD1	0
0x18D9	IIC2F	MULT			ICR				
0x18DA	IIC2C1	IICEN	IICIE	MST	TX	TXAK	RSTA	0	0
0x18DB	IIC2S	TCF	IAAS	BUSY	ARBL	0	SRW	IICIF	RXAK
0x18DC	IIC2D	DATA							
0x18DD	IIC2C2	GCAEN	ADEXT	0	0	0	AD10	AD9	AD8
0x18DE– 0x18FF	Reserved	—	—	—	—	—	—	—	—

Figure 4-4 shows the structure of receive and transmit buffers for extended identifier mapping. These registers vary depending on whether standard or extended mapping is selected. See [Chapter 12](#), “Freescale’s Controller Area Network (S08MSCANV1),” for details on extended and standard identifier mapping.

Table 4-4. MSCAN Foreground Receive and Transmit Buffer Layouts — Extended Mapping Shown (Sheet 1 of 2)

0x18A0	CANRIDR0	ID28	ID27	ID26	ID25	ID24	ID23	ID22	ID21
0x18A1	CANRIDR1	ID20	ID19	ID18	SRR ⁽¹⁾	IDE ⁽¹⁾	ID17	ID16	ID15
0x18A2	CANRIDR2	ID14	ID13	ID12	ID11	ID10	ID9	ID8	ID7
0x18A3	CANRIDR3	ID6	ID5	ID4	ID3	ID2	ID1	ID0	RTR ²
0x18A4 – 0x18AB	CANRDSR0 – CANRDSR7	DB7	DB6	DB5	DB4	DB3	DB2	DB1	DB0
0x18AC	CANRDLR	—	—	—	—	DLC3	DLC2	DLC1	DLC0
0x18AD	Reserved	—	—	—	—	—	—	—	—
0x18AE	CANRTSRH	TSR15	TSR14	TSR13	TSR12	TSR11	TSR10	TSR9	TSR8
0x18AF	CANRTSRL	TSR7	TSR6	TSR5	TSR4	TSR3	TSR2	TSR1	TSR0
0x18B0	CANTIDR0	ID28	ID27	ID26	ID25	ID24	ID23	ID22	ID21
0x18B1	CANTIDR1	ID20	ID19	ID18	SRR ⁽³⁾	IDE ⁽¹⁾	ID17	ID16	ID15
0x18B2	CANTIDR2	ID14	ID13	ID12	ID11	ID10	ID9	ID8	ID7

Table 4-4. MSCAN Foreground Receive and Transmit Buffer Layouts — Extended Mapping Shown (Sheet 2 of 2)

0x18B3	CANTIDR3	ID6	ID5	ID4	ID3	ID2	ID1	ID0	RTR ⁴
0x18B4 – 0x18BB	CANTDSR0 – CANTDSR7	DB7	DB6	DB5	DB4	DB3	DB2	DB1	DB0
0x18BC	CANTDLR	—	—	—	—	DLC3	DLC2	DLC1	DLC0
0x18BD	CANTTBPR	PRI07	PRI06	PRI05	PRI04	PRI03	PRI02	PRI01	PRI00
0x18BE	CANTTSRH	TSR15	TSR14	TSR13	TSR12	TSR11	TSR10	TSR9	TSR8
0x18BF	CANTTSRL	TSR7	TSR6	TSR5	TSR4	TSR3	TSR2	TSR1	TSR0

¹ SRR and IDE are both 1s.

² The position of RTR differs between extended and standard identifier mapping.

³ SRR and IDE are both 1s.

⁴ The position of RTR differs between extended and standard identifier mapping.

Nonvolatile FLASH registers, shown in [Table 4-5](#), are located in the FLASH memory. These registers include an 8-byte backdoor key, NVBACKKEY, which can be used to gain access to secure memory resources. During reset events, the contents of NVPROT and NVOPT in the nonvolatile register area of the FLASH memory are transferred into corresponding FPROT and FOPT working registers in the high-page registers to control security and block protection options.

The factory MCG trim value is stored in a nonvolatile location and will be loaded into the MCGTRM and MCGSC registers after any reset if not in a BDM mode. If in a BDM mode, a default value of 0x80 is loaded. The internal reference trim values stored in Flash (0xFFAE, 0xFFAF), TRIM and FTRIM, can be programmed by third party programmers and must be copied into the corresponding MCG registers by user code to override the factory trim.

Table 4-5. Nonvolatile Register Summary

Address	Register Name	Bit 7	6	5	4	3	2	1	Bit 0
0xFFAE	Reserved for storage of FTRIM	0	0	0	0	0	0	0	FTRIM
0xFFAF	Reserved for storage of MCGTRM	TRIM							
0xFFB0– 0xFFB7	NVBACKKEY	8-Byte Comparison Key							
0xFFB8– 0xFFBC	Reserved	—	—	—	—	—	—	—	—
0xFFBD	NVPROT	EPS			FPS				FPOP
0xFFBE	Reserved	—	—	—	—	—	—	—	—
0xFFBF	NVOPT	KEYEN	FNORED	EPGMOD	0	0	0	SEC	

Provided the key enable (KEYEN) bit is 1, the 8-byte comparison key can be used to temporarily disengage memory security. This key mechanism can be accessed only through user code running in secure memory. (A security key cannot be entered directly through background debug commands.) This security key can be disabled completely by programming the KEYEN bit to 0. If the security key is disabled, the only way to disengage security is by mass erasing the FLASH if needed (normally through the background

debug interface) and verifying that FLASH is blank. To avoid returning to secure mode after the next reset, program the security bits (SEC) to the unsecured state (1:0).

4.4 Memory Management Unit

The memory management unit (MMU) allows the program and data space for the HCS08 Family of Microcontrollers to be extended beyond the 64K CPU addressable memory map. The extended memory when used for data can also be accessed linearly using a linear address pointer and data access registers.

4.4.1 Features

Key features of the MMU module are:

- Memory Management Unit extends the HCS08 memory space
 - up to 128K for program and data space
- Extended program space using paging scheme
 - PPAGE register used for page selection
 - fixed 16K byte memory window
 - architecture supports eight 16K pages
- Extended data space using linear address pointer
 - 17-bit linear address pointer
 - linear address pointer and data register provided in direct page allows access of complete FLASH memory map using direct page instructions
 - optional auto increment of pointer when data accessed
 - supports a 2s complement addition/subtraction to address pointer without using any math instructions or memory resources
 - supports word accesses to any address specified by the linear address pointer when using LDHX, STHX instructions

4.4.2 Memory Expansion

The HCS08 Core architecture limits the CPU addressable space available to 64K bytes. The Program Page (PPAGE) allows for integrating up to 128K of FLASH into the system by selecting one of the 16K byte blocks to be accessed through the Paging Window located at 0x8000-0xBFFF. The MMU module also provides a linear address pointer that allows extension of data access up to 128K.

4.4.2.1 Program Space

The PPAGE register holds the page select value for the Paging Window. The value in PPAGE can be manipulated by using normal read and write instructions as well as the CALL and RTC instructions. The user should not change PPAGE directly when running from paged memory, only CALL and RTC should be used.

When the MMU detects that the CPU is addressing the Paging Window, the value currently in PPAGE will be used to create an extended address that the MCU's decode logic will use to select the desired FLASH location. For example, the Flash from location 0x4000-0x7FFF can be accessed directly or using the paging window, PPAGE = 1, address 0x8000-0xBFFF.

4.4.2.2 CALL and RTC (Return from Call) Instructions

CALL and RTC are instructions that perform automated page switching when executed in the user program. CALL is similar to a JSR instruction, but the subroutine that is called can be located anywhere in the normal 64K address space or on any page of program memory.

During the execution of a CALL instruction, the CPU:

- Stacks the return address.
- Pushes the current PPAGE value onto the stack.
- Writes the new instruction-supplied PPAGE value into the PPAGE register.
- Transfers control to the subroutine of the new instruction-supplied address.

This sequence is not interruptible; there is no need to inhibit interrupts during CALL execution. A CALL can be executed from any address in memory to any other address.

The new PPAGE value is provided by an immediate operand in the instruction along with the address within the paging window, 0x8000-0xBFFF.

RTC is similar to an RTS instruction.

The RTC instruction terminates subroutines invoked by a CALL instruction.

During the execution of an RTC instruction, the CPU:

- Pulls the old PPAGE value from the stack and loads it into the PPAGE register
- Pulls the 16-bit return address from the stack and loads it into the PC
- Resumes execution at the return address

This sequence is not interruptible; there is no need to inhibit interrupts during RTC execution. An RTC can be executed from any address in memory.

4.4.2.3 Data Space

The linear address pointer registers, LAP2:LAP0 along with the linear data register allow the CPU to read or write any address in the extended FLASH memory space. This linear address pointer may be used to access data from any memory location while executing code from any location in extended memory, including accessing data from a different PPAGE than the currently executing program.

To access data using the linear address pointer, the user would first setup the extended address in the 17-bit address pointer, LAP2:LAP0. Accessing one of the three linear data registers LB, LBP and LWP will access the extended memory location specified by LAP2:LAP0. The three linear data registers access the memory locations in the same way, however the LBP and LWP will also increment LAP2:LAP0.

Accessing either the LBP or LWP registers allows a user program to read successive memory locations without re-writing the linear address pointer. Accessing LBP or LWP does the exact same function. However, because of the address mapping of the registers with LBP following LWP, a user can do word accesses in the extended address space using the LDHX or STHX instructions to access location LWP.

The MMU supports the addition of a 2s complement value to the linear address pointer without using any math instructions or memory resources. Writes to LAPAB with a 2s complement value will cause the MMU to add that value to the existing value in LAP2:LAP0.

4.4.3 MMU Registers and Control Bits

4.4.3.1 Program Page Register (PPAGE)

The HCS08 Core architecture limits the CPU addressable space available to 64K bytes. The address space can be extended to 128K bytes using a paging window scheme. The Program Page (PPAGE) allows for selecting one of the 16K byte blocks to be accessed through the Program Page Window located at 0x8000-0xBFFF. The CALL and RTC instructions can load or store the value of PPAGE onto or from the stack during program execution. After any reset, PPAGE is set to PAGE 2.

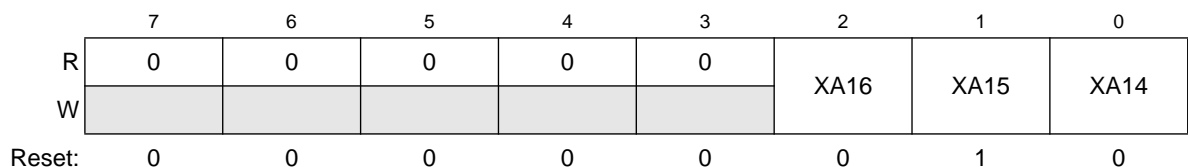

Figure 4-5. Program Page Register (PPAGE)

Table 4-6. Program Page Register Field Descriptions

Field	Description
2:0 XA16:XA14	When the CPU addresses the paging window, 0x8000-0xBFFF, the value in the PPAGE register along with the CPU addresses A13:A0 are used to create a 17-bit extended address.

4.4.3.2 Linear Address Pointer Registers 2:0 (LAP2:LAP0)

The three registers, LAP2:LAP0 contain the 17-bit linear address that allows the user to access any FLASH location in the extended address map. This register is used in conjunction with the data registers, linear byte (LB), linear byte post increment (LBP) and linear word post increment (LWP). The contents of LAP2:LAP0 will auto-increment when accessing data using the LBP and LWP registers. The contents of LAP2:LAP0 can be increased by writing an 8-bit value to LAPAB.

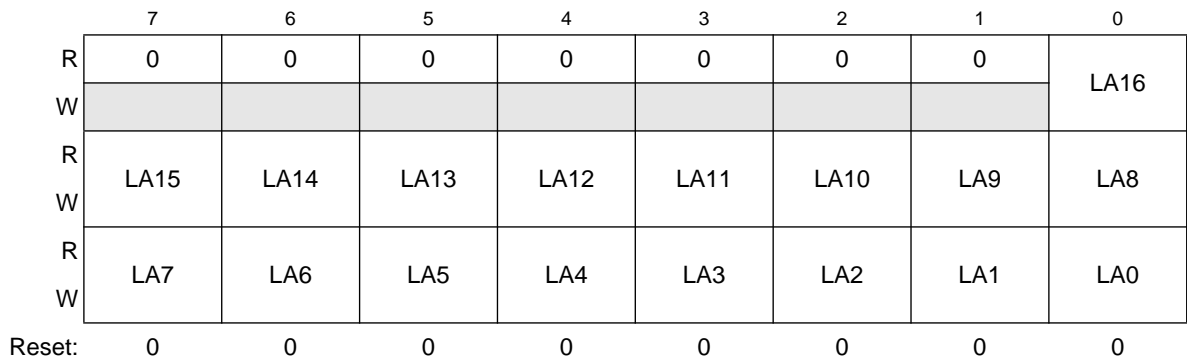

Figure 4-6. Linear Address Pointer Registers 2:0 (LAP2:LAP0)

Table 4-7. Linear Address Pointer Registers 2:0 Field Descriptions

Field	Description
16:0 LA16:LA0	The values in LAP2:LAP0 are used to create a 17-bit linear address pointer. The value in these registers are used as the extended address when accessing any of the data registers LB, LBP and LWP.

4.4.3.3 Linear Word Post Increment Register (LWP)

This register is one of three data registers that the user can use to access any FLASH memory location in the extended address map. When LWP is accessed the contents of LAP2:LAP0 make up the extended address of the FLASH memory location to be addressed. When accessing data using LWP, the contents of LAP2:LAP0 will increment after the read or write is complete.

Accessing LWP does the same thing as accessing LBP. The MMU register ordering of LWP followed by LBP, allow the user to access data by words using the LDHX or STHX instructions of the LWP register.

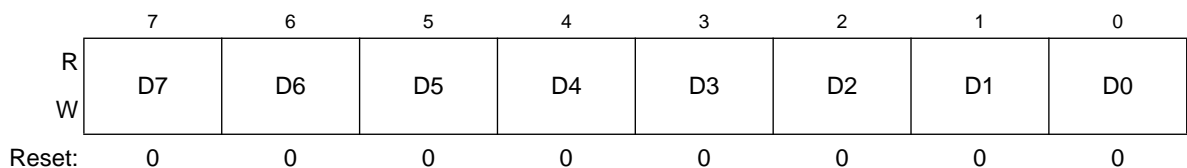

Figure 4-7. Linear Word Post Increment Register (LWP)

Table 4-8. Linear Word Post Increment Register Field Descriptions

Field	Description
7:0 D7:D0	Reads of this register will first return the data value pointed to by the linear address pointer, LAP2:LAP0 and then will increment LAP2:LAP0. Writes to this register will first write the data value to the memory location specified by the linear address pointer and then will increment LAP2:LAP0. Writes to this register are most commonly used when writing to the FLASH block(s) during programming.

4.4.3.4 Linear Byte Post Increment Register (LBP)

This register is one of three data registers that the user can use to access any FLASH memory location in the extended address map. When LBP is accessed the contents of LAP2:LAP0 make up the extended

address of the FLASH memory location to be addressed. When accessing data using LBP, the contents of LAP2:LAP0 will increment after the read or write is complete.

Accessing LBP does the same thing as accessing LWP. The MMU register ordering of LWP followed by LBP, allow the user to access data by words using the LDHX or STHX instructions with the address of the LWP register.

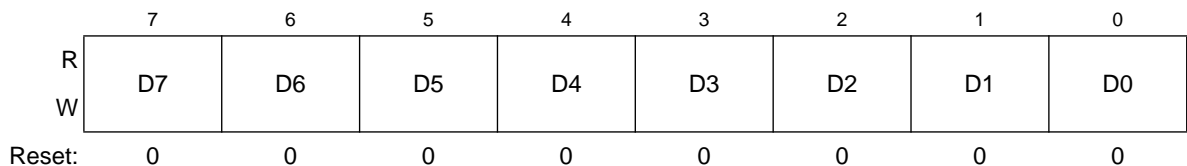

Figure 4-8. Linear Byte Post Increment Register (LBP)

Table 4-9. Linear Byte Post Increment Register Field Descriptions

Field	Description
7:0 D7:D0	Reads of this register will first return the data value pointed to by the linear address pointer, LAP2:LAP0 and then will increment LAP2:LAP0. Writes to this register will first write the data value to the memory location specified by the linear address pointer and then will increment LAP2:LAP0. Writes to this register are most commonly used when writing to the FLASH block(s) during programming.

4.4.3.5 Linear Byte Register (LB)

This register is one of three data registers that the user can use to access any FLASH memory location in the extended address map. When LB is accessed the contents of LAP2:LAP0 make up the extended address of the FLASH memory location to be addressed.

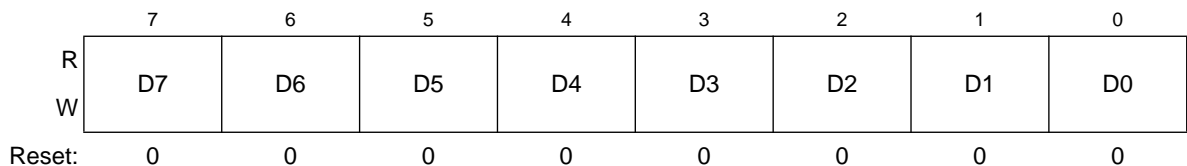

Figure 4-9. Linear Byte Register (LB)

Table 4-10. Linear Data Register Field Descriptions

Field	Description
7:0 D7:D0	Reads of this register returns the data value pointed to by the linear address pointer, LAP2:LAP0. Writes to this register will write the data value to the memory location specified by the linear address pointer. Writes to this register are most commonly used when writing to the FLASH block(s) during programming.

4.4.3.6 Linear Address Pointer Add Byte Register (LAPAB)

The user can increase or decrease the contents of LAP2:LAP0 by writing a 2s complement value to LAPAB. The value written will be added to the current contents of LAP2:LAP0.

	7	6	5	4	3	2	1	0
R	0	0	0	0	0	0	0	0
W	D7	D6	D5	D4	D3	D2	D1	D0
Reset:	0	0	0	0	0	0	0	0

Figure 4-10. Linear Address Pointer Add Byte Register (LAPAB)

Table 4-11. Linear Address Pointer Add Byte Register Field Descriptions

Field	Description
7:0 D7:D0	The 2s complement value written to LAPAB will be added to contents of the linear address pointer register, LAP2:LAP0. Writing a value of 0x7f to LAPAB will increase LAP by 127, a value of 0x80 will decrease LAP by 128, and a value of 0xff will decrease LAP by 1.

4.5 RAM

The MC9S08DZ128 Series includes static RAM. The locations in RAM below 0x0100 can be accessed using the more efficient direct addressing mode, and any single bit in this area can be accessed with the bit manipulation instructions (BCLR, BSET, BRCLR, and BRSET). Locating the most frequently accessed program variables in this area of RAM is preferred.

The RAM retains data while the MCU is in low-power wait, stop2, or stop3 mode. At power-on the contents of RAM are uninitialized. RAM data is unaffected by any reset if the supply voltage does not drop below the minimum value for RAM retention (V_{RAM}).

For compatibility with M68HC05 MCUs, the HCS08 resets the stack pointer to 0x00FF. In the MC9S08DZ128 Series, it is usually best to reinitialize the stack pointer to the top of the RAM so the direct page RAM can be used for frequently accessed RAM variables and bit-addressable program variables. Include the following 2-instruction sequence in your reset initialization routine (where RamLast is equated to the highest address of the RAM in the Freescale Semiconductor equate file).

```
LDHX    #RamLast+1    ;point one past RAM
TXS                    ;SP<-(H:X-1)
```

NOTE

On most devices in the MC9S08DZ128 Series, more than 4K of RAM is present in two separate address blocks.

When security is enabled, the RAM is considered a secure memory resource and is not accessible through BDM or code executing from non-secure memory. See [Section 4.6.9, “Security”](#), for a detailed description of the security feature.

4.6 FLASH and EEPROM

MC9S08DZ128 Series devices include FLASH and EEPROM memory intended primarily for program and data storage. In-circuit programming allows the operating program and data to be loaded into FLASH and EEPROM, respectively, after final assembly of the application product. It is possible to program the arrays through the single-wire background debug interface. Because no special voltages are needed for erase and programming operations, in-application programming is also possible through other software-controlled communication paths. For a more detailed discussion of in-circuit and in-application programming, refer to the *HCS08 Family Reference Manual, Volume I*, Freescale Semiconductor document order number HCS08RMv1.

4.6.1 Features

Features of the FLASH and EEPROM memory include:

- Up to 128K of FLASH and up to 2K of EEPROM (see [Table 1-1](#) for exact array sizes)
- FLASH sector size: 512 bytes
- EEPROM sector size: selectable 4-byte or 8-byte sector mapping operation
- Single power supply program and erase
- Command interface for fast program and erase operation
- Up to 100,000 program/erase cycles at typical voltage and temperature
- Flexible block protection
- Security feature for FLASH, EEPROM, and RAM
- Burst programming capability
- Sector erase abort

4.6.2 Program and Erase Times

Before any program or erase command can be accepted, the FLASH and EEPROM clock divider register (FCDIV) must be written to set the internal clock for the FLASH and EEPROM module to a frequency (f_{FCLK}) between 150 kHz and 200 kHz (see [Section 4.6.11.1](#), “FLASH and EEPROM Clock Divider Register (FCDIV)”). This register can be written only once, so normally this write is performed during reset initialization. The user must ensure that FACCERR is not set before writing to the FCDIV register. One period of the resulting clock ($1/f_{FCLK}$) is used by the command processor to time program and erase pulses. An integer number of these timing pulses is used by the command processor to complete a program or erase command.

NOTE

When changing from a low power mode (Stop2 mode or bus frequency less than 150kHz) into an operating condition that allows program or erase, it is necessary to wait at least 10 μ s before starting a program or erase command.

Table 4-12 shows program and erase times. The bus clock frequency and FCDIV determine the frequency of FCLK (f_{FCLK}). The time for one cycle of FCLK is $t_{FCLK} = 1/f_{FCLK}$. The times are shown as a number of cycles of FCLK and as an absolute time for the case where $t_{FCLK} = 5 \mu s$. Program and erase times shown include overhead for the command state machine and enabling and disabling of program and erase voltages.

Table 4-12. Program and Erase Times

Parameter	Cycles of FCLK	Time if FCLK = 200 kHz
Byte program	9	45 μs
Burst program	4	20 μs ¹
Sector erase	4000	20 ms
Mass erase	20,000	100 ms
Sector erase abort	4	20 μs ¹

¹ Excluding start/end overhead

4.6.3 Program and Erase Command Execution

The FCDIV register must be initialized after any reset and any error flag is cleared before beginning command execution. The command execution steps are:

1. Write a data value to an address in the FLASH or EEPROM array. The address and data information from this write is latched into the FLASH and EEPROM interface. This write is a required first step in any command sequence. For erase and blank check commands, the value of the data is not important. For sector erase commands, the address can be any address in the sector of FLASH or EEPROM to be erased. For mass erase and blank check commands, the address can be any address in the FLASH or EEPROM memory. FLASH and EEPROM erase independently of each other.

NOTE

Before programming a particular byte in the FLASH or EEPROM, the sector in which that particular byte resides must be erased by a mass or sector erase operation. Reprogramming bits in an already programmed byte without first performing an erase operation may disturb data stored in the FLASH or EEPROM memory.

2. Write the command code for the desired command to FCMD. The six valid commands are blank check (0x05), byte program (0x20), burst program (0x25), sector erase (0x40), mass erase (0x41), and sector erase abort (0x47). The command code is latched into the command buffer.
3. Write a 1 to the FCBEF bit in FSTAT to clear FCBEF and launch the command (including its address and data information).

A partial command sequence can be aborted manually by writing a 0 to FCBEF any time after the write to the memory array and before writing the 1 that clears FCBEF and launches the complete command. Aborting a command in this way sets the FACCERR access error flag which must be cleared before starting a new command.

A strictly monitored procedure must be obeyed or the command will not be accepted. This minimizes the possibility of any unintended changes to the memory contents. The command complete flag (FCCF) indicates when a command is complete. The command sequence must be completed by clearing FCBEF to launch the command. Figure 4-11 is a flowchart for executing all of the commands except for burst programming and sector erase abort.

4. Wait until the FCCF bit in FSTAT is set. As soon as FCCF= 1, the operation has completed successfully.

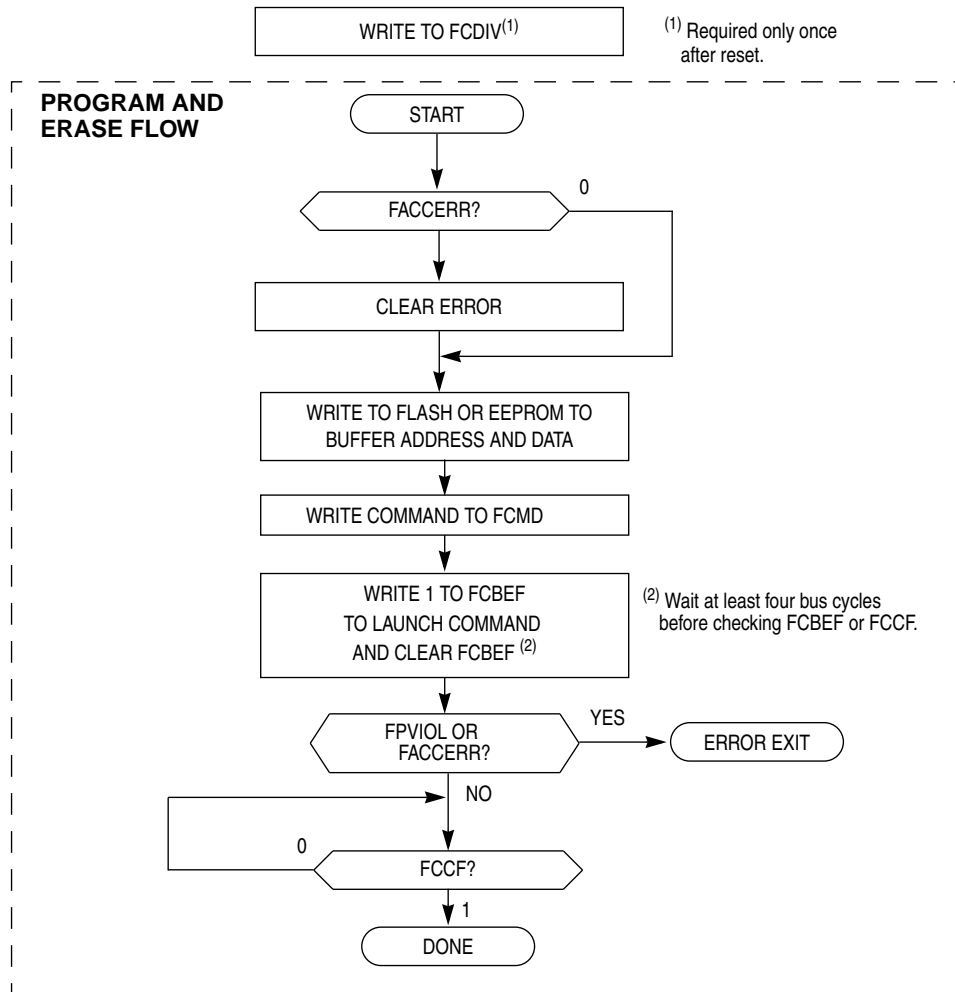

Figure 4-11. Program and Erase Flowchart

4.6.4 Burst Program Execution

The burst program command is used to program sequential bytes of data in less time than would be required using the standard program command. This is possible because the high voltage to the FLASH array does not need to be disabled between program operations. Ordinarily, when a program or erase command is issued, an internal charge pump associated with the FLASH memory must be enabled to supply high voltage to the array. Upon completion of the command, the charge pump is turned off. When

a burst program command is issued, the charge pump is enabled and remains enabled after completion of the burst program operation if these two conditions are met:

- The next burst program command sequence has begun before the FCCF bit is set.
- The next sequential address selects a byte on the same burst block as the current byte being programmed. A burst block in this FLASH memory consists of 32 bytes. A new burst block begins at each 32-byte address boundary.

The first byte of a series of sequential bytes being programmed in burst mode will take the same amount of time to program as a byte programmed in standard mode. Subsequent bytes will program in the burst program time provided that the conditions above are met. If the next sequential address is the beginning of a new row, the program time for that byte will be the standard time instead of the burst time. This is because the high voltage to the array must be disabled and then enabled again. If a new burst command has not been queued before the current command completes, then the charge pump will be disabled and high voltage removed from the array.

A flowchart to execute the burst program operation is shown in [Figure 4-12](#).

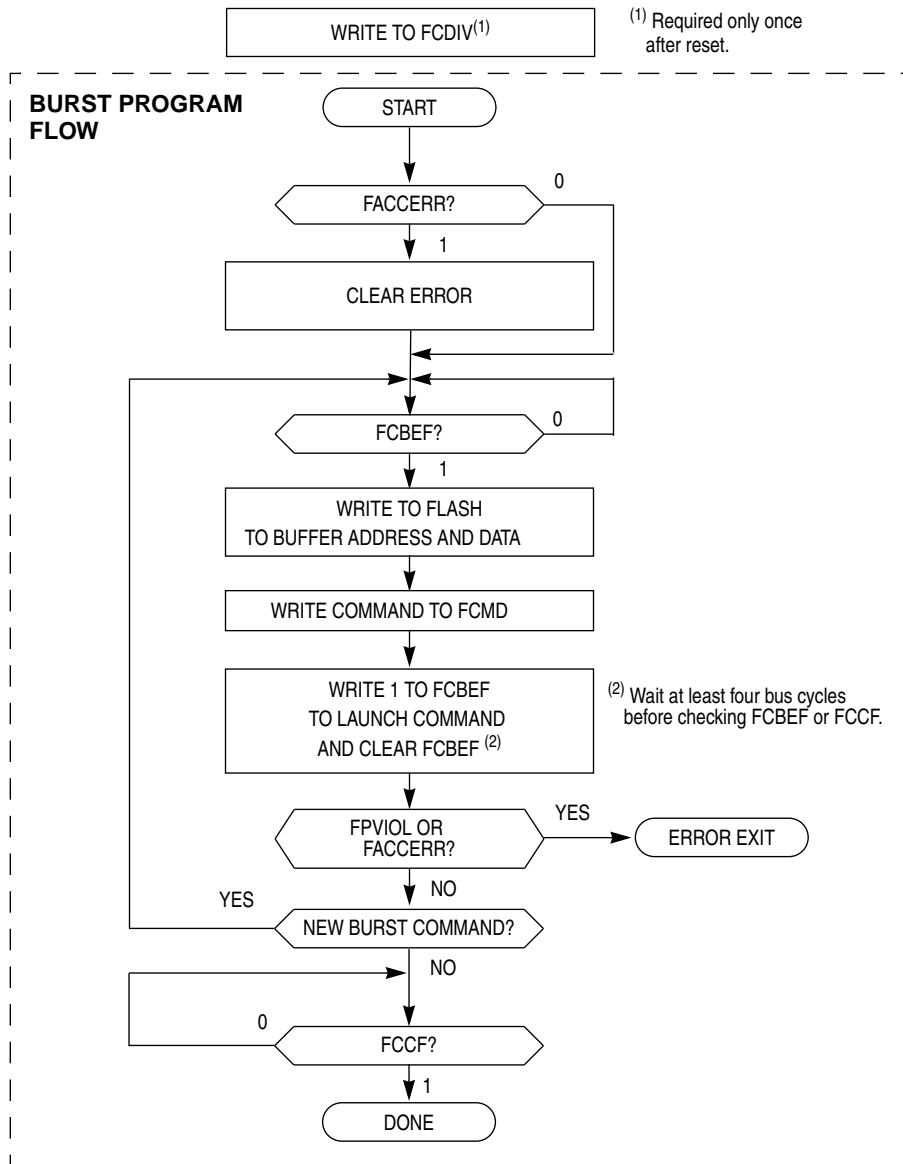

Figure 4-12. Burst Program Flowchart

4.6.5 Sector Erase Abort

The sector erase abort operation will terminate the active sector erase operation so that other sectors are available for read and program operations without waiting for the sector erase operation to complete.

The sector erase abort command write sequence is as follows:

1. Write to any FLASH or EEPROM address to start the command write sequence for the sector erase abort command. The address and data written are ignored.
2. Write the sector erase abort command, 0x47, to the FCMD register.
3. Clear the FCBEF flag in the FSTAT register by writing a 1 to FCBEF to launch the sector erase abort command.

If the sector erase abort command is launched resulting in the early termination of an active sector erase operation, the FACCERR flag will set once the operation completes as indicated by the FCCF flag being set. The FACCERR flag sets to inform the user that the FLASH sector may not be fully erased and a new sector erase command must be launched before programming any location in that specific sector.

If the sector erase abort command is launched but the active sector erase operation completes normally, the FACCERR flag will not set upon completion of the operation as indicated by the FCCF flag being set. Therefore, if the FACCERR flag is not set after the sector erase abort command has completed, a sector being erased when the abort command was launched will be fully erased.

A flowchart to execute the sector erase abort operation is shown in [Figure 4-13](#).

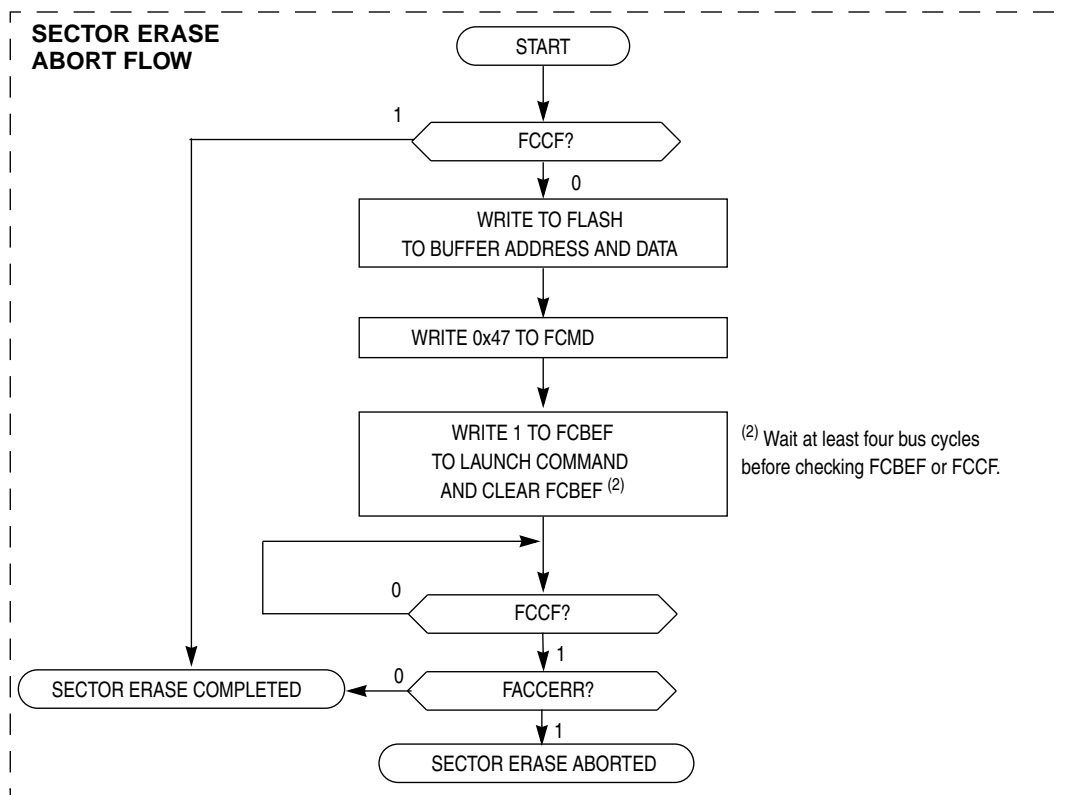

Figure 4-13. Sector Erase Abort Flowchart

NOTE

The FCBEF flag will not set after launching the sector erase abort command. If an attempt is made to start a new command write sequence with a sector erase abort operation active, the FACCERR flag in the FSTAT register will be set. A new command write sequence may be started after clearing the ACCERR flag, if set.

NOTE

The sector erase abort command should be used sparingly since a sector erase operation that is aborted counts as a complete program/erase cycle.

4.6.6 Access Errors

An access error occurs whenever the command execution protocol is violated.

Any of the following specific actions will cause the access error flag (FACCERR) in FSTAT to be set. FACCERR must be cleared by writing a 1 to FACCERR in FSTAT before any command can be processed.

- Writing to a FLASH address before the internal FLASH and EEPROM clock frequency has been set by writing to the FCDIV register.
- Writing to a FLASH address while FCBEF is not set. (A new command cannot be started until the command buffer is empty.)
- Writing a second time to a FLASH address before launching the previous command. (There is only one write to FLASH for every command.)
- Writing a second time to FCMD before launching the previous command. (There is only one write to FCMD for every command.)
- Writing to any FLASH control register other than FCMD after writing to a FLASH address.
- Writing any command code other than the six allowed codes (0x05, 0x20, 0x25, 0x40, 0x41, or 0x47) to FCMD.
- Accessing (read or write) any FLASH control register other than to write to FSTAT (to clear FCBEF and launch the command) after writing the command to FCMD.
- The MCU enters stop mode while a program or erase command is in progress. (The command is aborted.)
- Writing the byte program, burst program, sector erase or sector erase abort command code (0x20, 0x25, 0x40, or 0x47) with a background debug command while the MCU is secured. (The background debug controller can do blank check and mass erase commands only when the MCU is secure.)
- Writing 0 to FCBEF to cancel a partial command.

4.6.7 Block Protection

The block protection feature prevents the protected region of FLASH or EEPROM from program or erase changes. Block protection is controlled through the FLASH and EEPROM protection register (FPROT). The EPS bits determine the protected region of EEPROM and the FPS bits determine the protected region of FLASH. See [Section 4.6.11.4, “FLASH and EEPROM Protection Register \(FPROT and NVPROT\).”](#)

After exit from reset, FPROT is loaded with the contents of the NVPROT location, which is in the nonvolatile register block of the FLASH memory. FPROT cannot be changed directly from application software so a runaway program cannot alter the block protection settings. Because NVPROT is within the last sector of FLASH, if any amount of memory is protected, NVPROT is itself protected and cannot be altered (intentionally or unintentionally) by the application software. FPROT can be written through background debug commands, which provides a way to erase and reprogram protected FLASH memory.

One use for block protection is to block protect an area of FLASH memory for a bootloader program. This bootloader program then can be used to erase the rest of the FLASH memory and reprogram it. The bootloader is protected even if MCU power is lost during an erase and reprogram operation.

4.6.8 Vector Redirection

Whenever any FLASH is block protected, the reset and interrupt vectors will be protected. Vector redirection allows users to modify interrupt vector information without unprotecting bootloader and reset vector space. Vector redirection is enabled by programming the FNORED bit in the NVOPT register to 0. For redirection to occur, at least some portion of the FLASH memory must be block protected by programming the FPS bits in the NVPROT register. All interrupt vectors (memory locations 0x0_FF80 through 0x0_FFFD) are redirected, though the reset vector (0x0_FFFE:0x0_FFFF) is not.

For example, if 8192 bytes of FLASH are protected, the protected address region is from 0x0_E000 through 0x0_FFFF. The interrupt vectors (0x0_FF80 through 0x0_FFFD) are redirected to the locations 0x0_DF80 through 0x0_DFFD. If vector redirection is enabled and an interrupt occurs, the values in the locations 0x0_DFE0:0x0_DFE1 are used for the vector instead of the values in the locations 0x0_FFE0:0x0_FFE1. This allows the user to reprogram the unprotected portion of the FLASH with new program code including new interrupt vector values while leaving the protected area, which includes the default vector locations, unchanged.

4.6.9 Security

The MC9S08DZ128 Series includes circuitry to prevent unauthorized access to the contents of FLASH, EEPROM, and RAM memory. When security is engaged, FLASH, EEPROM, and RAM are considered secure resources. Direct-page registers, high-page registers, and the background debug controller are considered unsecured resources. Programs executing within secure memory have normal access to any MCU memory locations and resources. Attempts to access a secure memory location with a program executing from an unsecured memory space or through the background debug interface are blocked (writes are ignored and reads return all 0s).

Security is engaged or disengaged based on the state of two register bits (SEC[1:0]) in the FOPT register. During reset, the contents of the nonvolatile location NVOPT are copied from FLASH into the working FOPT register in high-page register space. A user engages security by programming the NVOPT location,

which can be performed at the same time the FLASH memory is programmed. The 1:0 state disengages security; the other three combinations engage security. Notice the erased state (1:1) makes the MCU secure. During development, whenever the FLASH is erased, it is good practice to immediately program the SEC0 bit to 0 in NVOPT so SEC = 1:0. This would allow the MCU to remain unsecured after a subsequent reset.

The on-chip debug module cannot be enabled while the MCU is secure. The separate background debug controller can be used for background memory access commands, but the MCU cannot enter active background mode except by holding BKGD low at the rising edge of reset.

A user can choose to allow or disallow a security unlocking mechanism through an 8-byte backdoor security key. If the nonvolatile KEYEN bit in NVOPT/FOPT is 0, the backdoor key is disabled and there is no way to disengage security without completely erasing all FLASH locations. If KEYEN is 1, a secure user program can temporarily disengage security by:

1. Writing 1 to KEYACC in the FCNFG register. This makes the FLASH module interpret writes to the backdoor comparison key locations (NVBACKKEY through NVBACKKEY+7) as values to be compared against the key rather than as the first step in a FLASH program or erase command.
2. Writing the user-entered key values to the NVBACKKEY through NVBACKKEY+7 locations. These writes must be performed in order starting with the value for NVBACKKEY and ending with NVBACKKEY+7. STHX must not be used for these writes because these writes cannot be performed on adjacent bus cycles. User software normally would get the key codes from outside the MCU system through a communication interface such as a serial I/O.
3. Writing 0 to KEYACC in the FCNFG register. If the 8-byte key that was written matches the key stored in the FLASH locations, SEC bits are automatically changed to 1:0 and security will be disengaged until the next reset.

The security key can be written only from secure memory (either RAM, EEPROM, or FLASH), so it cannot be entered through background commands without the cooperation of a secure user program.

The backdoor comparison key (NVBACKKEY through NVBACKKEY+7) is located in FLASH memory locations in the nonvolatile register space so users can program these locations exactly as they would program any other FLASH memory location. The nonvolatile registers are in the same 512-byte block of FLASH as the reset and interrupt vectors, so block protecting that space also block protects the backdoor comparison key. Block protects cannot be changed from user application programs, so if the vector space is block protected, the backdoor security key mechanism cannot permanently change the block protect, security settings, or the backdoor key.

Security can always be disengaged through the background debug interface by taking these steps:

1. Disable any block protections by writing FPROT. FPROT can be written only with background debug commands, not from application software.
2. Mass erase FLASH if necessary.
3. Blank check FLASH. Provided FLASH is completely erased, security is disengaged until the next reset.

To avoid returning to secure mode after the next reset, program NVOPT so SEC = 1:0.

4.6.10 EEPROM Mapping

Only half of the EEPROM is in the memory map. The EPGSEL bit in FCNFG register selects which half of the array can be accessed in foreground while the other half can not be accessed in background. There are two mapping mode options that can be selected to configure the 8-byte EEPROM sectors: 4-byte mode and 8-byte mode. Each mode is selected by the EPGMOD bit in the FOPT register.

In 4-byte sector mode (EPGMOD = 0), each 8-byte sector splits four bytes on foreground and four bytes on background but on the same addresses. The EPGSEL bit selects which four bytes can be accessed. During a sector erase, the entire 8-byte sector (four bytes in foreground and four bytes in background) is erased.

In 8-byte sector mode (EPGMOD = 1), each entire 8-byte sector is in a single page. The EPGSEL bit selects which sectors are on background. During a sector erase, the entire 8-byte sector in foreground is erased.

4.6.11 FLASH and EEPROM Registers and Control Bits

The FLASH and EEPROM modules have seven 8-bit registers in the high-page register space and three locations in the nonvolatile register space in FLASH memory. Two of those locations are copied into two corresponding high-page control registers at reset. There is also an 8-byte comparison key in FLASH memory. Refer to [Table 4-3](#) and [Table 4-5](#) for the absolute address assignments for all FLASH and EEPROM registers. This section refers to registers and control bits only by their names. A Freescale Semiconductor-provided equate or header file normally is used to translate these names into the appropriate absolute addresses.

4.6.11.1 FLASH and EEPROM Clock Divider Register (FCDIV)

Bit 7 of this register is a read-only status flag. Bits 6 through 0 may be read at any time but can be written only one time. Before any erase or programming operations are possible, write to this register to set the frequency of the clock for the nonvolatile memory system within acceptable limits.

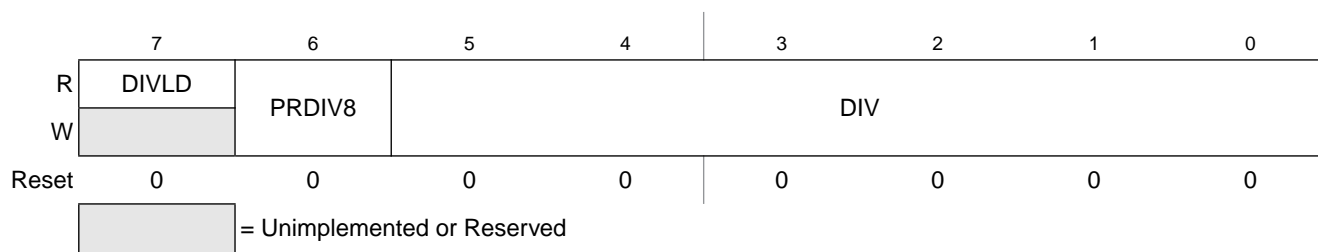

Figure 4-14. FLASH and EEPROM Clock Divider Register (FCDIV)

Table 4-13. FCDIV Register Field Descriptions

Field	Description
7 DIVLD	<p>Divisor Loaded Status Flag — When set, this read-only status flag indicates that the FCDIV register has been written since reset. Reset clears this bit and the first write to this register causes this bit to become set regardless of the data written.</p> <p>0 FCDIV has not been written since reset; erase and program operations disabled for FLASH and EEPROM. 1 FCDIV has been written since reset; erase and program operations enabled for FLASH and EEPROM.</p>
6 PRDIV8	<p>Prescale (Divide) FLASH and EEPROM Clock by 8 (This bit is write once.)</p> <p>0 Clock input to the FLASH and EEPROM clock divider is the bus rate clock. 1 Clock input to the FLASH and EEPROM clock divider is the bus rate clock divided by 8.</p>
5:0 DIV	<p>Divisor for FLASH and EEPROM Clock Divider — The FLASH and EEPROM clock divider divides the bus rate clock (or the bus rate clock divided by 8 if PRDIV8 = 1) by the value in the 6-bit DIV field plus one. The resulting frequency of the internal FLASH and EEPROM clock must fall within the range of 200 kHz to 150 kHz for proper FLASH and EEPROM operations. Program/Erase timing pulses are one cycle of this internal FLASH and EEPROM clock which corresponds to a range of 5 μs to 6.7 μs. The automated programming logic uses an integer number of these pulses to complete an erase or program operation. See Equation 4-1 and Equation 4-2.</p>

$$\text{if PRDIV8} = 0 \text{ — } f_{\text{FCLK}} = f_{\text{Bus}} \div (\text{DIV} + 1) \quad \text{Eqn. 4-1}$$

$$\text{if PRDIV8} = 1 \text{ — } f_{\text{FCLK}} = f_{\text{Bus}} \div (8 \times (\text{DIV} + 1)) \quad \text{Eqn. 4-2}$$

Table 4-14 shows the appropriate values for PRDIV8 and DIV for selected bus frequencies.

Table 4-14. FLASH and EEPROM Clock Divider Settings

f_{Bus}	PRDIV8 (Binary)	DIV (Decimal)	f_{FCLK}	Program/Erase Timing Pulse (5 μs Min, 6.7 μs Max)
20 MHz	1	12	192.3 kHz	5.2 μs
10 MHz	0	49	200 kHz	5 μs
8 MHz	0	39	200 kHz	5 μs
4 MHz	0	19	200 kHz	5 μs
2 MHz	0	9	200 kHz	5 μs
1 MHz	0	4	200 kHz	5 μs
200 kHz	0	0	200 kHz	5 μs
150 kHz	0	0	150 kHz	6.7 μs

4.6.11.2 FLASH and EEPROM Options Register (FOPT and NVOPT)

During reset, the contents of the nonvolatile location NVOPT are copied from FLASH into FOPT. To change the value in this register, erase and reprogram the NVOPT location in FLASH memory as usual and then issue a new MCU reset.

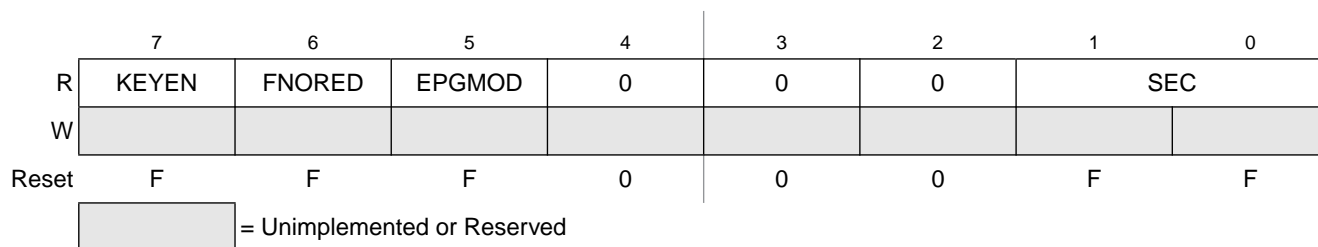

Figure 4-15. FLASH and EEPROM Options Register (FOPT)

Table 4-15. FOPT Register Field Descriptions

Field	Description
7 KEYEN	Backdoor Key Mechanism Enable — When this bit is 0, the backdoor key mechanism cannot be used to disengage security. The backdoor key mechanism is accessible only from user (secured) firmware. BDM commands cannot be used to write key comparison values that would unlock the backdoor key. For more detailed information about the backdoor key mechanism, refer to Section 4.6.9, “Security.” 0 No backdoor key access allowed. 1 If user firmware writes an 8-byte value that matches the nonvolatile backdoor key (NVBACKKEY through NVBACKKEY+7 in that order), security is temporarily disengaged until the next MCU reset.
6 FNORED	Vector Redirection Disable — When this bit is 1, vector redirection is disabled. 0 Vector redirection enabled. 1 Vector redirection disabled.

Table 4-15. FOPT Register Field Descriptions

Field	Description
5 EPGMOD	EEPROM Sector Mode — When this bit is 0, each sector is split into two pages (4-byte mode). When this bit is 1, each sector is in a single page (8-byte mode). 0 Half of each EEPROM sector is in Page 0 and the other half is in Page 1. 1 Each sector is in a single page.
1:0 SEC	Security State Code — This 2-bit field determines the security state of the MCU as shown in Table 4-16. When the MCU is secure, the contents of RAM, EEPROM and FLASH memory cannot be accessed by instructions from any unsecured source including the background debug interface. SEC changes to 1:0 after successful backdoor key entry or a successful blank check of FLASH. For more detailed information about security, refer to Section 4.6.9, “Security.”

Table 4-16. Security States¹

SEC[1:0]	Description
0:0	secure
0:1	secure
1:0	unsecured
1:1	secure

¹ SEC changes to 1:0 after successful backdoor key entry or a successful blank check of FLASH.

4.6.11.3 FLASH and EEPROM Configuration Register (FCNFG)

	7	6	5	4	3	2	1	0
R	0	EPGSEL	KEYACC	1	0	0	0	1
W								
Reset	0	0	0	1	0	0	0	1

= Unimplemented or Reserved

Figure 4-16. FLASH and EEPROM Configuration Register (FCNFG)
Table 4-17. FCNFG Register Field Descriptions

Field	Description
6 EPGSEL	EEPROM Page Select — This bit selects which EEPROM page is accessed in the memory map. 0 Page 0 is in foreground of memory map. Page 1 is in background and can not be accessed. 1 Page 1 is in foreground of memory map. Page 0 is in background and can not be accessed.
5 KEYACC	Enable Writing of Access Key — This bit enables writing of the backdoor comparison key. For more detailed information about the backdoor key mechanism, refer to Section 4.6.9, “Security.” 0 Writes to 0xFFB0–0xFFB7 are interpreted as the start of a FLASH programming or erase command. 1 Writes to NVBACKKEY (0xFFB0–0xFFB7) are interpreted as comparison key writes.

4.6.11.4 FLASH and EEPROM Protection Register (FPROT and NVPROT)

The FPROT register defines which FLASH and EEPROM sectors are protected against program and erase operations.

During the reset sequence, the FPROT register is loaded from the nonvolatile location NVPROT. To change the protection that will be loaded during the reset sequence, the sector containing NVPROT must be unprotected and erased, then NVPROT can be reprogrammed.

FPROT bits are readable at any time and writable as long as the size of the protected region is being increased. Any write to FPROT that attempts to decrease the size of the protected memory will be ignored.

Trying to alter data in any protected area will result in a protection violation error and the FPVIOL flag will be set in the FSTAT register. Mass erase is not possible if any one of the sectors is protected.

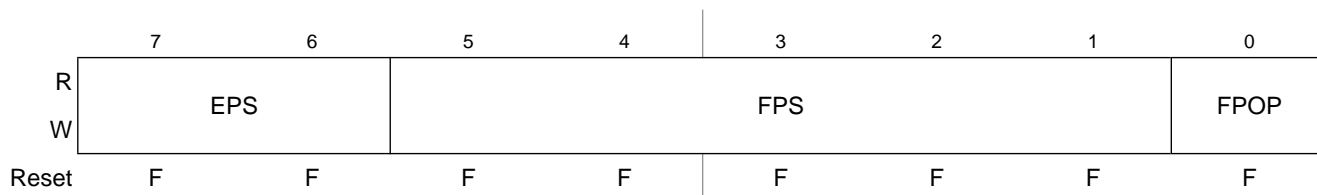

Figure 4-17. FLASH and EEPROM Protection Register (FPROT)

Table 4-18. FPROT Register Field Descriptions

Field	Description
7:6 EPS	EEPROM Protect Select Bits — This 2-bit field determines the protected EEPROM locations that cannot be erased or programmed. See Table 4-19 .
5:1 FPS	FLASH Protect Select Bits — With FPOP set, this 5-bit field determines the protected FLASH locations that cannot be erased or programmed. See Table 4-20 .
0 FPOP	FLASH Protection Open 0 Flash is fully protected. 1 Flash protected address range determined by FPS bits.

Table 4-19. EEPROM Block Protection

EPS	Protected Address Range	Protected Size
0x3	No protection	0 bytes
0x2	3FF0 - 3FFF	32 bytes
0x1	3FE0 - 3FFF	64 bytes
0x0	3FC0-3FFF	128 bytes

Table 4-20. FLASH Block Protection

FPS	FPOP	Protected Address Range Relative to Flash Array base		Protected Size
		Flash Array 0	Flash Array 1	
0x1F	1	No protection	No protection	0 Kbytes
0x1E		0x0_E000–0x0_FFFF		8 Kbytes
0x1D		0x0_C000–0x0_FFFF		16 Kbytes
0x1C		0x0_A000–0x0_FFFF		24 Kbytes
0x1B		0x0_8000–0x0_FFFF		32 Kbytes
0x1A		0x0_6000–0x0_FFFF		40 Kbytes
0x19		0x0_4000–0x0_FFFF		48 Kbytes
0x18		0x0_2000–0x0_FFFF		56 Kbytes
0x17		0x0_0000–0x0_FFFF		64 Kbytes
0x16		0x0_0000–0x0_FFFF	0x1_F000–0x1_FFFF	68 Kbytes
0x15		0x0_0000–0x0_FFFF	0x1_E000–0x1_FFFF	72 Kbytes
0x14		0x0_0000–0x0_FFFF	0x1_D000–0x1_FFFF	76 Kbytes
0x13		0x0_0000–0x0_FFFF	0x1_C000–0x1_FFFF	80 Kbytes
0x12		0x0_0000–0x0_FFFF	0x1_B000–0x1_FFFF	84 Kbytes
0x11		0x0_0000–0x0_FFFF	0x1_A000–0x1_FFFF	88 Kbytes
0x10		0x0_0000–0x0_FFFF	0x1_9000–0x1_FFFF	92 Kbytes
0x0F		0x0_0000–0x0_FFFF	0x1_8000–0x1_FFFF	96 Kbytes
0x0E		0x0_0000–0x0_FFFF	0x1_7800–0x1_FFFF	98 Kbytes
0x0D		0x0_0000–0x0_FFFF	0x1_7000–0x1_FFFF	100 Kbytes
0x0C		0x0_0000–0x0_FFFF	0x1_6800–0x1_FFFF	102 Kbytes
...	
0x05		0x0_0000–0x0_FFFF	0x1_3000–0x1_FFFF	116 Kbytes
0x04		0x0_0000–0x0_FFFF	0x1_2800–0x1_FFFF	118 Kbytes
0x03		0x0_0000–0x0_FFFF	0x1_2000–0x1_FFFF	120 Kbytes
0x02		0x0_0000–0x0_FFFF	0x1_1800–0x1_FFFF	122 Kbytes
0x01		0x0_0000–0x0_FFFF	0x1_1000–0x1_FFFF	124 Kbytes
0x00		0x0_0000–0x0_FFFF	0x1_0800–0x1_FFFF	126 Kbytes
-	0	0x0_0000–0x0_FFFF	0x1_0000–0x1_FFFF	128 Kbytes

4.6.11.5 FLASH and EEPROM Status Register (FSTAT)

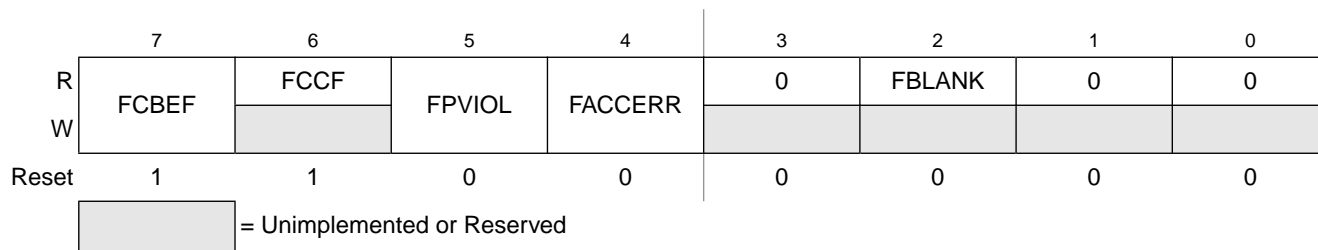

Figure 4-18. FLASH and EEPROM Status Register (FSTAT)

Table 4-21. FSTAT Register Field Descriptions

Field	Description
7 FCBEF	<p>Command Buffer Empty Flag — The FCBEF bit is used to launch commands. It also indicates that the command buffer is empty so that a new command sequence can be executed when performing burst programming. The FCBEF bit is cleared by writing a 1 to it or when a burst program command is transferred to the array for programming. Only burst program commands can be buffered.</p> <p>0 Command buffer is full (not ready for additional commands). 1 A new burst program command can be written to the command buffer.</p>
6 FCCF	<p>Command Complete Flag — FCCF is set automatically when the command buffer is empty and no command is being processed. FCCF is cleared automatically when a new command is started (by writing 1 to FCBEF to register a command). Writing to FCCF has no meaning or effect.</p> <p>0 Command in progress 1 All commands complete</p>
5 FPVIOL	<p>Protection Violation Flag — FPVIOL is set automatically when a command that attempts to erase or program a location in a protected block (the erroneous command is ignored). FPVIOL is cleared by writing a 1 to FPVIOL.</p> <p>0 No protection violation. 1 An attempt was made to erase or program a protected location.</p>
4 FACCERR	<p>Access Error Flag — FACCERR is set automatically when the proper command sequence is not obeyed exactly (the erroneous command is ignored), if a program or erase operation is attempted before the FCDIV register has been initialized, or if the MCU enters stop while a command was in progress. For a more detailed discussion of the exact actions that are considered access errors, see Section 4.6.6, “Access Errors.” FACCERR is cleared by writing a 1 to FACCERR. Writing a 0 to FACCERR has no meaning or effect.</p> <p>0 No access error. 1 An access error has occurred.</p>
2 FBLANK	<p>Verified as All Blank (erased) Flag — FBLANK is set automatically at the conclusion of a blank check command if the entire FLASH or EEPROM array was verified to be erased. FBLANK is cleared by clearing FCBEF to write a new valid command. Writing to FBLANK has no meaning or effect.</p> <p>0 After a blank check command is completed and FCCF = 1, FBLANK = 0 indicates the FLASH or EEPROM array is not completely erased. 1 After a blank check command is completed and FCCF = 1, FBLANK = 1 indicates the FLASH or EEPROM array is completely erased (all 0xFFFF).</p>

4.6.11.6 FLASH and EEPROM Command Register (FCMD)

Only six command codes are recognized in normal user modes, as shown in [Table 4-22](#). All other command codes are illegal and generate an access error. Refer to [Section 4.6.3, “Program and Erase](#)

Command Execution,” for a detailed discussion of FLASH and EEPROM programming and erase operations.

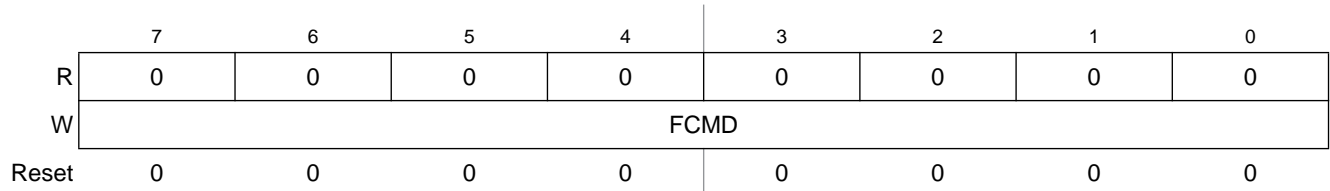

Figure 4-19. FLASH and EEPROM Command Register (FCMD)

Table 4-22. FLASH and EEPROM Commands

Command	FCMD	Equate File Label
Blank check	0x05	mBlank
Byte program	0x20	mByteProg
Burst program	0x25	mBurstProg
Sector erase	0x40	mSectorErase
Mass erase	0x41	mMassErase
Sector erase abort	0x47	mEraseAbort

It is not necessary to perform a blank check command after a mass erase operation. Only blank check is required as part of the security unlocking mechanism.

Chapter 5

Resets, Interrupts, and General System Control

5.1 Introduction

This section discusses basic reset and interrupt mechanisms and their various sources in the MC9S08DZ128 Series. Some interrupt sources from peripheral modules are discussed in greater detail within other sections of this data sheet. This section gathers basic information about all reset and interrupt sources in one place for easy reference. A few reset and interrupt sources, including the computer operating properly (COP) watchdog, are not part of on-chip peripheral systems with their own chapters.

5.2 Features

Reset and interrupt features include:

- Multiple sources of reset for flexible system configuration and reliable operation
- Reset status register (SRS) to indicate source of most recent reset
- Separate interrupt vector for each module (reduces polling overhead); see [Table 5-1](#)

5.3 MCU Reset

Resetting the MCU provides a way to start processing from a known set of initial conditions. During reset, most control and status registers are forced to initial values and the program counter is loaded from the reset vector (0xFFFF:0xFFFF). On-chip peripheral modules are disabled and I/O pins are initially configured as general-purpose high-impedance inputs with pull-up devices disabled. The I bit in the condition code register (CCR) is set to block maskable interrupts so the user program has a chance to initialize the stack pointer (SP) and system control settings. (See the CPU chapter for information on the Interrupt (I) bit.) SP is forced to 0x00FF at reset.

The MC9S08DZ128 Series has eight sources for reset:

- Power-on reset (POR)
- External pin reset (PIN)
- Computer operating properly (COP) timer
- Illegal opcode detect (ILOP)
- Illegal address detect (ILAD)
- Low-voltage detect (LVD)
- Loss of clock (LOC)
- Background debug forced reset (BDFR)

Each of these sources, with the exception of the background debug forced reset, has an associated bit in the system reset status register (SRS). Whenever the MCU enters reset, the reset pin is driven low for 34

bus cycles. After the 34 cycles are completed, the pin is released and will be pulled up by the internal pull-up resistor, unless it is held low externally. After the pin is released, it is sampled after another 38 cycles to determine whether the reset pin is the cause of the MCU reset.

5.4 Computer Operating Properly (COP) Watchdog

The COP watchdog is intended to force a system reset when the application software fails to execute as expected. To prevent a system reset from the COP timer (when it is enabled), application software must reset the COP counter periodically. If the application program gets lost and fails to reset the COP counter before it times out, a system reset is generated to force the system back to a known starting point.

After any reset, the COP watchdog is enabled (see [Section 5.8.4, “System Options Register 1 \(SOPT1\),”](#) for additional information). If the COP watchdog is not used in an application, it can be disabled by clearing COPT bits in SOPT1.

The COP counter is reset by writing 0x0055 and 0x00AA (in this order) to the address of SRS during the selected timeout period. Writes do not affect the data in the read-only SRS. As soon as the write sequence is done, the COP timeout period is restarted. If the program fails to do this during the time-out period, the MCU will reset. Also, if any value other than 0x0055 or 0x00AA is written to SRS, the MCU is immediately reset.

The COPCLKS bit in SOPT2 (see [Section 5.8.5, “System Options Register 2 \(SOPT2\),”](#) for additional information) selects the clock source used for the COP timer. The clock source options are either the bus clock or an internal 1-kHz clock source. With each clock source, there are three associated time-outs controlled by the COPT bits in SOPT1. [Table 5-6](#) summarizes the control functions of the COPCLKS and COPT bits. The COP watchdog defaults to operation from the 1-kHz clock source and the longest time-out (2^{10} cycles).

When the bus clock source is selected, windowed COP operation is available by setting COPW in the SOPT2 register. In this mode, writes to the SRS register to clear the COP timer must occur in the last 25% of the selected timeout period. A premature write immediately resets the MCU. When the 1-kHz clock source is selected, windowed COP operation is not available.

The COP counter is initialized by the first writes to the SOPT1 and SOPT2 registers and after any system reset. Subsequent writes to SOPT1 and SOPT2 have no effect on COP operation. Even if the application will use the reset default settings of COPT, COPCLKS, and COPW bits, the user should write to the write-once SOPT1 and SOPT2 registers during reset initialization to lock in the settings. This will prevent accidental changes if the application program gets lost.

The write to SRS that services (clears) the COP counter should not be placed in an interrupt service routine (ISR) because the ISR could continue to be executed periodically even if the main application program fails.

If the bus clock source is selected, the COP counter does not increment while the MCU is in background debug mode or while the system is in stop mode. The COP counter resumes when the MCU exits background debug mode or stop mode.

If the 1-kHz clock source is selected, the COP counter is re-initialized to zero upon entry to either background debug mode or stop mode and begins from zero upon exit from background debug mode or stop mode.

5.5 Interrupts

Interrupts provide a way to save the current CPU status and registers, execute an interrupt service routine (ISR), and then restore the CPU status so processing resumes where it left off before the interrupt. Other than the software interrupt (SWI), which is a program instruction, interrupts are caused by hardware events such as an edge on the IRQ pin or a timer-overflow event. The debug module can also generate an SWI under certain circumstances.

If an event occurs in an enabled interrupt source, an associated read-only status flag will become set. The CPU will not respond unless the local interrupt enable is a 1 to enable the interrupt and the I bit in the CCR is 0 to allow interrupts. The global interrupt mask (I bit) in the CCR is initially set after reset which prevents all maskable interrupt sources. The user program initializes the stack pointer and performs other system setup before clearing the I bit to allow the CPU to respond to interrupts.

When the CPU receives a qualified interrupt request, it completes the current instruction before responding to the interrupt. The interrupt sequence obeys the same cycle-by-cycle sequence as the SWI instruction and consists of:

- Saving the CPU registers on the stack
- Setting the I bit in the CCR to mask further interrupts
- Fetching the interrupt vector for the highest-priority interrupt that is currently pending
- Filling the instruction queue with the first three bytes of program information starting from the address fetched from the interrupt vector locations

While the CPU is responding to the interrupt, the I bit is automatically set to avoid the possibility of another interrupt interrupting the ISR itself (this is called nesting of interrupts). Normally, the I bit is restored to 0 when the CCR is restored from the value stacked on entry to the ISR. In rare cases, the I bit can be cleared inside an ISR (after clearing the status flag that generated the interrupt) so that other interrupts can be serviced without waiting for the first service routine to finish. This practice is not recommended for anyone other than the most experienced programmers because it can lead to subtle program errors that are difficult to debug.

The interrupt service routine ends with a return-from-interrupt (RTI) instruction which restores the CCR, A, X, and PC registers to their pre-interrupt values by reading the previously saved information from the stack.

NOTE

For compatibility with M68HC08 devices, the H register is not automatically saved and restored. It is good programming practice to push H onto the stack at the start of the interrupt service routine (ISR) and restore it immediately before the RTI that is used to return from the ISR.

If more than one interrupt is pending when the I bit is cleared, the highest priority source is serviced first (see [Table 5-1](#)).

5.5.1 Interrupt Stack Frame

Figure 5-1 shows the contents and organization of a stack frame. Before the interrupt, the stack pointer (SP) points at the next available byte location on the stack. The current values of CPU registers are stored on the stack starting with the low-order byte of the program counter (PCL) and ending with the CCR. After stacking, the SP points at the next available location on the stack which is the address that is one less than the address where the CCR was saved. The PC value that is stacked is the address of the instruction in the main program that would have executed next if the interrupt had not occurred.

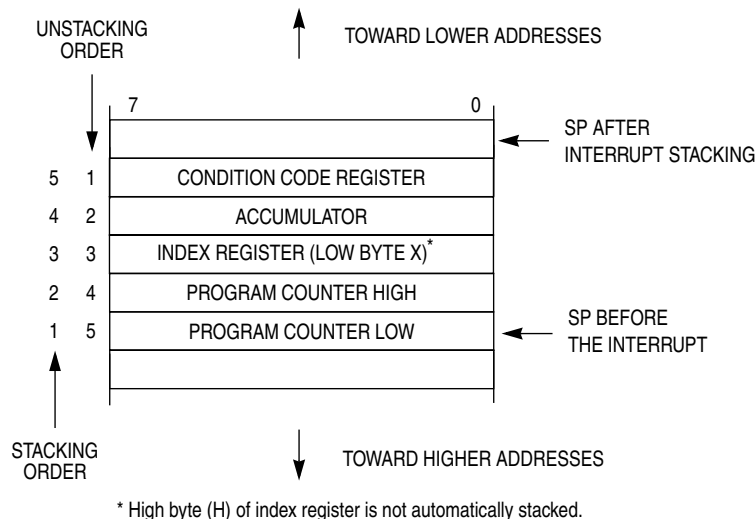

Figure 5-1. Interrupt Stack Frame

When an RTI instruction is executed, these values are recovered from the stack in reverse order. As part of the RTI sequence, the CPU fills the instruction pipeline by reading three bytes of program information, starting from the PC address recovered from the stack.

The status flag corresponding to the interrupt source must be acknowledged (cleared) before returning from the ISR. Typically, the flag is cleared at the beginning of the ISR so that if another interrupt is generated by this same source, it will be registered so it can be serviced after completion of the current ISR.

5.5.2 External Interrupt Request (IRQ) Pin

External interrupts are managed by the IRQ status and control register, IRQSC. When the IRQ function is enabled, synchronous logic monitors the pin for edge-only or edge-and-level events. When the MCU is in stop mode and system clocks are shut down, a separate asynchronous path is used so the IRQ (if enabled) can wake the MCU.

5.5.2.1 Pin Configuration Options

The IRQ pin enable (IRQPE) control bit in IRQSC must be 1 in order for the IRQ pin to act as the interrupt request (IRQ) input. As an IRQ input, the user can choose the polarity of edges or levels detected (IRQEDG), whether the pin detects edges-only or edges and levels (IRQMOD), and whether an event causes an interrupt or only sets the IRQF flag which can be polled by software.

The IRQ pin, when enabled, defaults to use an internal pull device ($IRQPDD = 0$), the device is a pull-up or pull-down depending on the polarity chosen. If the user desires to use an external pull-up or pull-down, the $IRQPDD$ can be written to a 1 to turn off the internal device.

BIH and BIL instructions may be used to detect the level on the IRQ pin when the pin is configured to act as the IRQ input.

5.5.2.2 Edge and Level Sensitivity

The $IRQMOD$ control bit reconfigures the detection logic so it detects edge events and pin levels. In the edge and level detection mode, the $IRQF$ status flag becomes set when an edge is detected (when the IRQ pin changes from the deasserted to the asserted level), but the flag is continuously set (and cannot be cleared) as long as the IRQ pin remains at the asserted level.

5.5.3 Interrupt Vectors, Sources, and Local Masks

Table 5-1 provides a summary of all interrupt sources. Higher-priority sources are located toward the bottom of the table. The high-order byte of the address for the interrupt service routine is located at the first address in the vector address column, and the low-order byte of the address for the interrupt service routine is located at the next higher address.

When an interrupt condition occurs, an associated flag bit becomes set. If the associated local interrupt enable is 1, an interrupt request is sent to the CPU. Within the CPU, if the global interrupt mask (I bit in the CCR) is 0, the CPU will finish the current instruction; stack the PCL, PCH, X, A, and CCR CPU registers; set the I bit; and then fetch the interrupt vector for the highest priority pending interrupt. Processing then continues in the interrupt service routine.

Table 5-1. Vector Summary¹

Vector Number	Address (High/Low)	Vector Name	Module	Source	Enable	Description	
56-63	0xFF80/0xFF81 - 0xFF8E/0xFF8F	Reserved					
55	0xFF90/0xFF91	Vportj	Port J	PTJIF	PTJIE	Port J Pins	
54	0xFF92/0xFF93	Viic1	IIC2	IICIS	IICIE	IIC2 control	
53	0xFF94/0xFF95	Vspi2	SPI2	SPIF, MODF, SPTEF	SPIE, SPIE, SPTIE	SPI2	
52	0xFF96/0xFF97	Vtpm3ovf	TPM3	TOF	TOIE	TPM3 overflow	
51	0xFF98/0xFF99	Vtpm3ch3	TPM3	CH1F	CH3IE	TPM3 channel 3	
50	0xFF9A/0xFF9B	Vtpm3ch2	TPM3	CH0F	CH2IE	TPM3 channel 2	
49	0xFF9C/0xFF9D	Vtpm3ch1	TPM3	CH1F	CH1IE	TPM3 channel 1	
48	0xFF9E/0xFF9F	Vtpm3ch0	TPM3	CH0F	CH0IE	TPM3 channel 0	
N/A	0xFFA0 - 0xFFBF	Non-vector space					
31	0xFFC0/0xFFC1	Vacmp2	ACMP2	ACF	ACIE	Analog comparator 2	
30	0xFFC2/0xFFC3	Vacmp1	ACMP1	ACF	ACIE	Analog comparator 1	
29	0xFFC4/0xFFC5	Vcantx	MSCAN	TXE[2:0]	TXEIE[2:0]	CAN transmit	
28	0xFFC6/0xFFC7	Vcanrx	MSCAN	RXF	RXFIE	CAN receive	
27	0xFFC8/0xFFC9	Vcanerr	MSCAN	CSCIF, OVRIF	CSCIE, OVRIE	CAN errors	
26	0xFFCA/0xFFCB	Vcanwu	MSCAN	WUPIF	WUPIE	CAN wake-up	
25	0xFFCC/0xFFCD	Vrtc	RTC	RTIF	RTIE	Real-time interrupt	
24	0xFFCE/0xFFCF	Viic1	IIC1	IICIS	IICIE	IIC1 control	
23	0xFFD0/0xFFD1	Vadc	ADC	COCOF	AIEN	ADC	
22	0xFFD2/0xFFD3	Vport	Port A,B,D	PTAIF, PTBIF, PTDIF	PTAIE, PTBIE, PTDIE	Port A, B and D Pins	
21	0xFFD4/0xFFD5	Vsci2tx	SCI2	TDRE, TC	TIE, TCIE	SCI2 transmit	
20	0xFFD6/0xFFD7	Vsci2rx	SCI2	IDLE, LBKDIF, RDRF, RXEDGIF	ILIE, LBKDIE, RIE, RXEDGIE	SCI2 receive	
19	0xFFD8/0xFFD9	Vsci2err	SCI2	OR, NF, FE, PF	ORIE, NFIE, FEIE, PFIE	SCI2 error	
18	0xFFDA/0xFFDB	Vsci1tx	SCI1	TDRE, TC	TIE, TCIE	SCI1 transmit	
17	0xFFDC/0xFFDD	Vsci1rx	SCI1	IDLE, LBKDIF, RDRF, RXEDGIF	ILIE, LBKDIE, RIE, RXEDGIE	SCI1 receive	
16	0xFFDE/0xFFDF	Vsci1err	SCI1	OR, NF, FE, PF	ORIE, NFIE, FEIE, PFIE	SCI1 error	
15	0xFFE0/0xFFE1	Vspi1	SPI1	SPIF, MODF, SPTEF	SPIE, SPIE, SPTIE	SPI1	
14	0xFFE2/0xFFE3	Vtpm2ovf	TPM2	TOF	TOIE	TPM2 overflow	
13	0xFFE4/0xFFE5	Vtpm2ch1	TPM2	CH1F	CH1IE	TPM2 channel 1	
12	0xFFE6/0xFFE7	Vtpm2ch0	TPM2	CH0F	CH0IE	TPM2 channel 0	
11	0xFFE8/0xFFE9	Vtpm1ovf	TPM1	TOF	TOIE	TPM1 overflow	
10	0xFFEA/0xFFEB	Vtpm1ch5	TPM1	CH5F	CH5IE	TPM1 channel 5	
9	0xFFEC/0xFFED	Vtpm1ch4	TPM1	CH4F	CH4IE	TPM1 channel 4	
8	0xFFEE/0xFFEF	Vtpm1ch3	TPM1	CH3F	CH3IE	TPM1 channel 3	
7	0xFFFF0/0xFFFF1	Vtpm1ch2	TPM1	CH2F	CH2IE	TPM1 channel 2	

Table 5-1. Vector Summary¹

Vector Number	Address (High/Low)	Vector Name	Module	Source	Enable	Description
6	0xFFFF2/0xFFFF3	Vtpm1ch1	TPM1	CH1F	CH1IE	TPM1 channel 1
5	0xFFFF4/0xFFFF5	Vtpm1ch0	TPM1	CH0F	CH0IE	TPM1 channel 0
4	0xFFFF6/0xFFFF7	Vlol	MCG	LOLS	LOLIE	MCG loss of lock
3	0xFFFF8/0xFFFF9	Vlvd	System control	LVWF	LVWIE	Low-voltage warning
2	0xFFFFA/0xFFFFB	Virq	IRQ	IRQF	IRQIE	IRQ pin
1	0xFFFFC/0xFFFFD	Vswi	Core	SWI Instruction	—	Software interrupt
0	0xFFFFE/0xFFFFF	Vreset	System control	COP, LOC, LVD, RESET, ILOP, ILAD, POR, BDFR	COPT CME LVDRE — — — — —	Watchdog timer Loss-of-clock Low-voltage detect External pin Illegal opcode Illegal address Power-on-reset BDM-forced reset

¹ Vector priority is shown from lowest (first row) to highest (last row). For example, Vreset is the highest priority vector.

5.6 Low-Voltage Detect (LVD) System

The MC9S08DZ128 Series includes a system to protect against low-voltage conditions in order to protect memory contents and control MCU system states during supply voltage variations. The system is comprised of a power-on reset (POR) circuit and a LVD circuit with trip voltages for warning and detection. The LVD circuit is enabled when LVDE in SPMSC1 is set to 1. The LVD is disabled upon entering any of the stop modes unless LVDSE is set in SPMSC1. If LVDSE and LVDE are both set, then the MCU cannot enter stop2 (it will enter stop3 instead), and the current consumption in stop3 with the LVD enabled will be higher.

5.6.1 Power-On Reset Operation

When power is initially applied to the MCU, or when the supply voltage drops below the power-on reset rearm voltage level, V_{POR} , the POR circuit will cause a reset condition. As the supply voltage rises, the LVD circuit will hold the MCU in reset until the supply has risen above the low-voltage detection low threshold, V_{LVDL} . Both the POR bit and the LVD bit in SRS are set following a POR.

5.6.2 Low-Voltage Detection (LVD) Reset Operation

The LVD can be configured to generate a reset upon detection of a low-voltage condition by setting LVDRE to 1. The low-voltage detection threshold is determined by the LVDV bit. After an LVD reset has occurred, the LVD system will hold the MCU in reset until the supply voltage has risen above the low-voltage detection threshold. The LVD bit in the SRS register is set following either an LVD reset or POR.

5.6.3 Low-Voltage Warning (LVW) Interrupt Operation

The LVD system has a low-voltage warning flag to indicate to the user that the supply voltage is approaching the low-voltage condition. When a low-voltage warning condition is detected and is configured for interrupt operation (LVWIE set to 1), LVWF in SPMSC1 will be set and an LVW interrupt request will occur.

5.7 MCLK Output

The PTA0 pin is shared with the MCLK clock output. If the MCSEL bits are all zeroes, the MCLK clock is disabled. Setting any of the MCSEL bits causes the PTA0 pin to output a divided version of the internal MCU bus clock regardless of the state of the port data direction control bit for the pin. The divide ratio is determined by the MCSEL bits. The slew rate and drive strength for the pin are controlled by PTASE0 and PTADS0, respectively.

5.8 Reset, Interrupt, and System Control Registers and Control Bits

One 8-bit register in the direct page register space and eight 8-bit registers in the high-page register space are related to reset and interrupt systems.

Refer to [Table 4-2](#) and [Table 4-3](#) in [Chapter 4, “Memory,”](#) of this data sheet for the absolute address assignments for all registers. This section refers to registers and control bits only by their names. A Freescale-provided equate or header file is used to translate these names into the appropriate absolute addresses.

Some control bits in the SOPT1 and SPMSC2 registers are related to modes of operation. Although brief descriptions of these bits are provided here, the related functions are discussed in greater detail in [Chapter 3, “Modes of Operation.”](#)

5.8.1 Interrupt Pin Request Status and Control Register (IRQSC)

This direct page register includes status and control bits which are used to configure the IRQ function, report status, and acknowledge IRQ events.

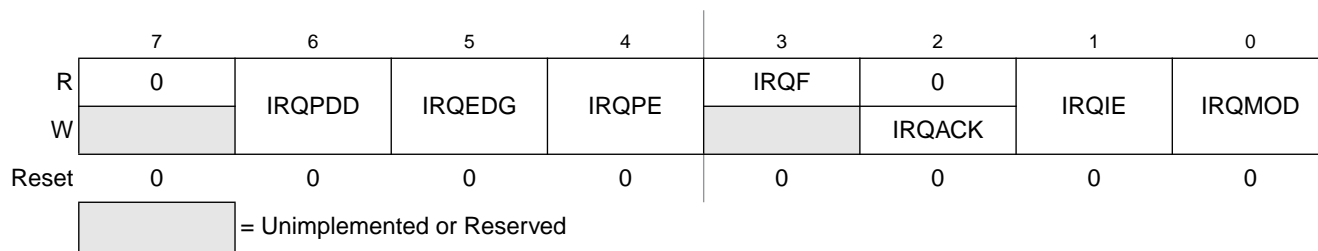

Figure 5-2. Interrupt Request Status and Control Register (IRQSC)

Table 5-2. IRQSC Register Field Descriptions

Field	Description
6 IRQPDD	Interrupt Request (IRQ) Pull Device Disable — This read/write control bit is used to disable the internal pull-up/pull-down device when the IRQ pin is enabled (IRQPE = 1) allowing for an external device to be used. 0 IRQ pull device enabled if IRQPE = 1. 1 IRQ pull device disabled if IRQPE = 1.
5 IRQEDG	Interrupt Request (IRQ) Edge Select — This read/write control bit is used to select the polarity of edges or levels on the IRQ pin that cause IRQF to be set. The IRQMOD control bit determines whether the IRQ pin is sensitive to both edges and levels or only edges. When the IRQ pin is enabled as the IRQ input and is configured to detect rising edges, it has a pull-down. When the IRQ pin is enabled as the IRQ input and is configured to detect falling edges, it has a pull-up. 0 IRQ is falling edge or falling edge/low-level sensitive. 1 IRQ is rising edge or rising edge/high-level sensitive.
4 IRQPE	IRQ Pin Enable — This read/write control bit enables the IRQ pin function. When this bit is set the IRQ pin can be used as an interrupt request. 0 IRQ pin function is disabled. 1 IRQ pin function is enabled.
3 IRQF	IRQ Flag — This read-only status bit indicates when an interrupt request event has occurred. 0 No IRQ request. 1 IRQ event detected.
2 IRQACK	IRQ Acknowledge — This write-only bit is used to acknowledge interrupt request events (write 1 to clear IRQF). Writing 0 has no meaning or effect. Reads always return 0. If edge-and-level detection is selected (IRQMOD = 1), IRQF cannot be cleared while the IRQ pin remains at its asserted level.
1 IRQIE	IRQ Interrupt Enable — This read/write control bit determines whether IRQ events generate an interrupt request. 0 Interrupt request when IRQF set is disabled (use polling). 1 Interrupt requested whenever IRQF = 1.
0 IRQMOD	IRQ Detection Mode — This read/write control bit selects either edge-only detection or edge-and-level detection. The IRQEDG control bit determines the polarity of edges and levels that are detected as interrupt request events. See Section 5.5.2.2, “Edge and Level Sensitivity” for more details. 0 IRQ event on falling edges or rising edges only. 1 IRQ event on falling edges and low levels or on rising edges and high levels.

5.8.2 System Reset Status Register (SRS)

This high page register includes read-only status flags to indicate the source of the most recent reset. When a debug host forces reset by writing 1 to BDFR in the SBDFR register, none of the status bits in SRS will be set. Writing any value to this register address causes a COP reset when the COP is enabled except the values 0x55 and 0xAA. Writing a 0x55-0xAA sequence to this address clears the COP watchdog timer without affecting the contents of this register. The reset state of these bits depends on what caused the MCU to reset.

	7	6	5	4	3	2	1	0
R	POR	PIN	COP	ILOP	ILAD	LOC	LVD	0
W	Writing 0x55, 0xAA to SRS address clears COP watchdog timer.							
POR:	1	0	0	0	0	0	1	0
LVD:	0	0	0	0	0	0	1	0
Any other reset:	0	Note ⁽¹⁾	Note ⁽¹⁾	Note ⁽¹⁾	Note ⁽¹⁾	0	0	0

¹ Any of these reset sources that are active at the time of reset entry will cause the corresponding bit(s) to be set; bits corresponding to sources that are not active at the time of reset entry will be cleared.

Figure 5-3. System Reset Status (SRS)

Table 5-3. SRS Register Field Descriptions

Field	Description
7 POR	Power-On Reset — Reset was caused by the power-on detection logic. Because the internal supply voltage was ramping up at the time, the low-voltage reset (LVD) status bit is also set to indicate that the reset occurred while the internal supply was below the LVD threshold. 0 Reset not caused by POR. 1 POR caused reset.
6 PIN	External Reset Pin — Reset was caused by an active-low level on the external reset pin. 0 Reset not caused by external reset pin. 1 Reset came from external reset pin.
5 COP	Computer Operating Properly (COP) Watchdog — Reset was caused by the COP watchdog timer timing out. This reset source can be blocked by COPT bits = 0:0. 0 Reset not caused by COP timeout. 1 Reset caused by COP timeout.
4 ILOP	Illegal Opcode — Reset was caused by an attempt to execute an unimplemented or illegal opcode. The STOP instruction is considered illegal if stop is disabled by STOPE = 0 in the SOPT register. The BGND instruction is considered illegal if active background mode is disabled by ENBDM = 0 in the BDCSC register. 0 Reset not caused by an illegal opcode. 1 Reset caused by an illegal opcode.
3 ILAD	Illegal Address — Reset was caused by an attempt to access either data or an instruction at an unimplemented memory address. 0 Reset not caused by an illegal address. 1 Reset caused by an illegal address.

Table 5-3. SRS Register Field Descriptions

Field	Description
2 LOC	Loss of Clock — Reset was caused by a loss of external clock. 0 Reset not caused by loss of external clock 1 Reset caused by loss of external clock
1 LVD	Low-Voltage Detect — If the LVDRE bit is set and the supply drops below the LVD trip voltage, an LVD reset will occur. This bit is also set by POR. 0 Reset not caused by LVD trip or POR. 1 Reset caused by LVD trip or POR.

5.8.3 System Background Debug Force Reset Register (SBDFR)

This high page register contains a single write-only control bit. A serial background command such as WRITE_BYTE must be used to write to SBDFR. Attempts to write this register from a user program are ignored. Reads always return 0x00.

	7	6	5	4	3	2	1	0
R	0	0	0	0	0	0	0	0
W								BDFR ¹
Reset:	0	0	0	0	0	0	0	0

 = Unimplemented or Reserved

¹ BDFR is writable only through serial background debug commands, not from user programs.

Figure 5-4. System Background Debug Force Reset Register (SBDFR)
Table 5-4. SBDFR Register Field Descriptions

Field	Description
0 BDFR	Background Debug Force Reset — A serial background command such as WRITE_BYTE can be used to allow an external debug host to force a target system reset. Writing 1 to this bit forces an MCU reset. This bit cannot be written from a user program.

5.8.4 System Options Register 1 (SOPT1)

This high page register is a write-once register so only the first write after reset is honored. It can be read at any time. Any subsequent attempt to write to SOPT1 (intentionally or unintentionally) is ignored to avoid accidental changes to these sensitive settings. This register should be written during the user's reset initialization program to set the desired controls even if the desired settings are the same as the reset settings.

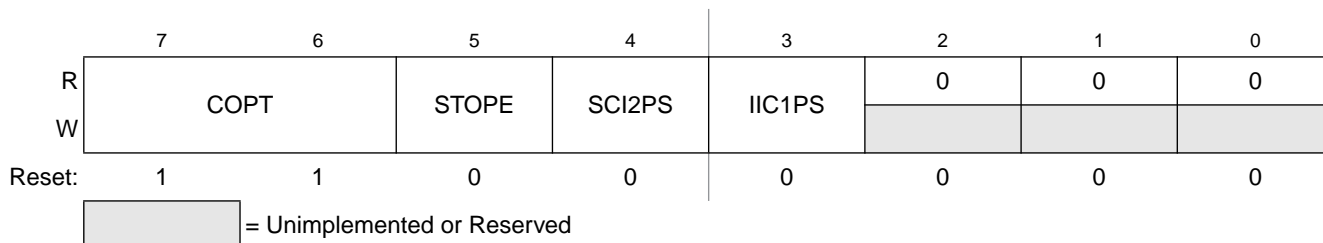

Figure 5-5. System Options Register 1 (SOPT1)

Table 5-5. SOPT1 Register Field Descriptions

Field	Description
7:6 COPT[1:0]	COP Watchdog Timeout — These write-once bits select the timeout period of the COP. COPT along with COPCLKS in SOPT2 defines the COP timeout period. See Table 5-6 .
5 STOPE	Stop Mode Enable — This write-once bit is used to enable stop mode. If stop mode is disabled and a user program attempts to execute a STOP instruction, an illegal opcode reset is forced. 0 Stop mode disabled. 1 Stop mode enabled.
4 SCI2PS	SCI2 Pin Select — This write-once bit selects the location of the RxD2 and TxD2 pins of the SCI2 module. 0 TxD2 on PTF0, RxD2 on PTF1. 1 TxD2 on PTE6, RxD2 on PTE7.
3 IIC1PS	IIC1 Pin Select — This write-once bit selects the location of the SCL1 and SDA1 pins of the IIC1 module. 0 SCL1 on PTF2, SDA1 on PTF3. 1 SCL1 on PTE4, SDA1 on PTE5.

Table 5-6. COP Configuration Options

Control Bits		Clock Source	COP Window ¹ Opens (COPW = 1)	COP Overflow Count
COPCLKS	COPT[1:0]			
N/A	0:0	N/A	N/A	COP is disabled
0	0:1	1 kHz	N/A	2 ⁵ cycles (32 ms ²)
0	1:0	1 kHz	N/A	2 ⁸ cycles (256 ms ¹)
0	1:1	1 kHz	N/A	2 ¹⁰ cycles (1.024 s ¹)
1	0:1	Bus	6144 cycles	2 ¹³ cycles
1	1:0	Bus	49,152 cycles	2 ¹⁶ cycles
1	1:1	Bus	196,608 cycles	2 ¹⁸ cycles

¹ Windowed COP operation requires the user to clear the COP timer in the last 25% of the selected timeout period. This column displays the minimum number of clock counts required before the COP timer can be reset when in windowed COP mode (COPW = 1).

² Values shown in milliseconds based on $t_{LPO} = 1$ ms. See t_{LPO} in the appendix [Section A.12.1, "Control Timing,"](#) for the tolerance of this value.

5.8.5 System Options Register 2 (SOPT2)

This high page register contains bits to configure MCU specific features on the MC9S08DZ128 Series devices.

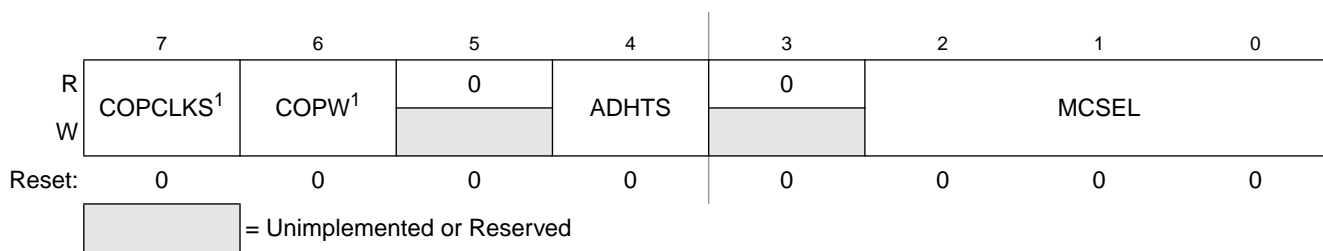

Figure 5-6. System Options Register 2 (SOPT2)

¹ This bit can be written only one time after reset. Additional writes are ignored.

Table 5-7. SOPT2 Register Field Descriptions

Field	Description
7 COPCLKS	COP Watchdog Clock Select — This write-once bit selects the clock source of the COP watchdog. See Table 5-6 for details. 0 Internal 1-kHz clock is source to COP. 1 Bus clock is source to COP.
6 COPW	COP Window — This write-once bit selects the COP operation mode. When set, the 0x55-0xAA write sequence to the SRS register must occur in the last 25% of the selected period. Any write to the SRS register during the first 75% of the selected period will reset the MCU. 0 Normal COP operation. 1 Window COP operation (only if COPCLKS=1).
4 ADHTS	ADC Hardware Trigger Select — This bit selects which hardware trigger initiates conversion for the analog to digital converter when the ADC hardware trigger is enabled (ADCTRG is set in ADCSC2 register). 0 Real Time Counter (RTC) overflow. 1 External Interrupt Request (IRQ) pin.
2:0 MCSEL	MCLK Divide Select — These bits enable the MCLK output on PTA0 pin and select the divide ratio for the MCLK output according to the formula below when the MCSEL bits are not equal to all zeroes. In case that the MCSEL bits are all zeroes, the MCLK output is disabled. $\text{MCLK frequency} = \text{Bus Clock frequency} \div (2 * \text{MCSEL})$

5.8.6 System Device Identification Register (SDIDH, SDIDL)

These high page read-only registers are included so host development systems can identify the HCS08 derivative and revision number. This allows the development software to recognize where specific memory blocks, registers, and control bits are located in a target MCU.

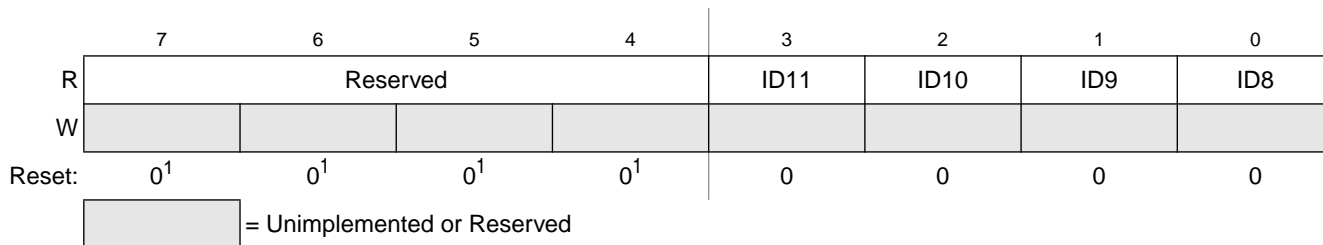

¹ The revision number that is hard coded into these bits reflects the current silicon revision level.

Figure 5-7. System Device Identification Register — High (SDIDH)

Table 5-8. SDIDH Register Field Descriptions

Field	Description
3:0 ID[11:8]	Part Identification Number — MC9S08DZ128 Series MCUs are hard-coded to the value 0x0019. See also ID bits in Table 5-9 .

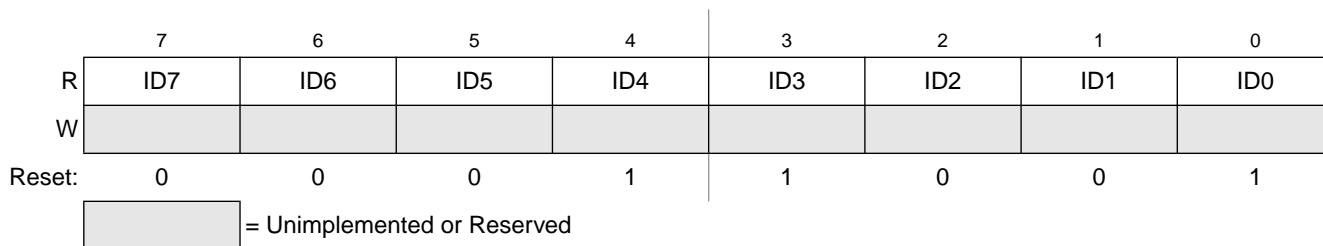

Figure 5-8. System Device Identification Register — Low (SDIDL)

Table 5-9. SDIDL Register Field Descriptions

Field	Description
7:0 ID[7:0]	Part Identification Number — MC9S08DZ128 Series MCUs are hard-coded to the value 0x0019. See also ID bits in Table 5-8 .

5.8.7 System Power Management Status and Control 1 Register (SPMSC1)

This high page register contains status and control bits to support the low-voltage detect function, and to enable the bandgap voltage reference for use by the ADC and ACMP modules. This register should be written during the user's reset initialization program to set the desired controls even if the desired settings are the same as the reset settings.

	7	6	5	4	3	2	1	0
R	LVWF ¹	0	LVWIE	LVDRE ²	LVDSE	LVDE ²	0	BGBE
W		LVWACK						
Reset:	0	0	0	1	1	1	0	0

= Unimplemented or Reserved

¹ LVWF will be set in the case when V_{Supply} transitions below the trip point or after reset and V_{Supply} is already below V_{LVW} .

² This bit can be written only one time after reset. Additional writes are ignored.

Figure 5-9. System Power Management Status and Control 1 Register (SPMSC1)

Table 5-10. SPMSC1 Register Field Descriptions

Field	Description
7 LVWF	Low-Voltage Warning Flag — The LVWF bit indicates the low-voltage warning status. 0 low-voltage warning is not present. 1 low-voltage warning is present or was present.
6 LVWACK	Low-Voltage Warning Acknowledge — If LVWF = 1, a low-voltage condition has occurred. To acknowledge this low-voltage warning, write 1 to LVWACK, which will automatically clear LVWF to 0 if the low-voltage warning is no longer present.
5 LVWIE	Low-Voltage Warning Interrupt Enable — This bit enables hardware interrupt requests for LVWF. 0 Hardware interrupt disabled (use polling). 1 Request a hardware interrupt when LVWF = 1.
4 LVDRE	Low-Voltage Detect Reset Enable — This write-once bit enables LVD events to generate a hardware reset (provided LVDE = 1). 0 LVD events do not generate hardware resets. 1 Force an MCU reset when an enabled low-voltage detect event occurs.
3 LVDSE	Low-Voltage Detect Stop Enable — Provided LVDE = 1, this read/write bit determines whether the low-voltage detect function operates when the MCU is in stop mode. 0 Low-voltage detect disabled during stop mode. 1 Low-voltage detect enabled during stop mode.
2 LVDE	Low-Voltage Detect Enable — This write-once bit enables low-voltage detect logic and qualifies the operation of other bits in this register. 0 LVD logic disabled. 1 LVD logic enabled.
0 BGBE	Bandgap Buffer Enable — This bit enables an internal buffer for the bandgap voltage reference for use by the ADC and ACMP modules on one of its internal channels. 0 Bandgap buffer disabled. 1 Bandgap buffer enabled.

5.8.8 System Power Management Status and Control 2 Register (SPMSC2)

This register is used to report the status of the low-voltage warning function, and to configure the stop mode behavior of the MCU. This register should be written during the user's reset initialization program to set the desired controls even if the desired settings are the same as the reset settings.

	7	6	5	4	3	2	1	0
R	0	0	LVDV ¹	LVWV	PPDF	0	0	PPDC ²
W							PPDACK	
Power-on Reset:	0	0	0	0	0	0	0	0
LVD Reset:	0	0	u	u	0	0	0	0
Any other Reset:	0	0	u	u	0	0	0	0

= Unimplemented or Reserved
 u = Unaffected by reset

¹ This bit can be written only one time after power-on reset. Additional writes are ignored.

² This bit can be written only one time after reset. Additional writes are ignored.

Figure 5-10. System Power Management Status and Control 2 Register (SPMSC2)

Table 5-11. SPMSC2 Register Field Descriptions

Field	Description
5 LVDV	Low-Voltage Detect Voltage Select — This write-once bit selects the low-voltage detect (LVD) trip point setting. It also selects the warning voltage range. See Table 5-12 .
4 LVWV	Low-Voltage Warning Voltage Select — This bit selects the low-voltage warning (LVW) trip point voltage. See Table 5-12 .
3 PPDF	Partial Power Down Flag — This read-only status bit indicates that the MCU has recovered from stop2 mode. 0 MCU has not recovered from stop2 mode. 1 MCU recovered from stop2 mode.
2 PPDACK	Partial Power Down Acknowledge — Writing a 1 to PPDACK clears the PPDF bit.
0 PPDC	Partial Power Down Control — This write-once bit controls whether stop2 or stop3 mode is selected. 0 Stop3 mode enabled. 1 Stop2, partial power down, mode enabled.

Table 5-12. LVD and LVW Trip Point Typical Values¹

LVDV:LVWV	LVW Trip Point	LVD Trip Point
0:0	$V_{LVW0} = 2.74 \text{ V}$	$V_{LVD0} = 2.56 \text{ V}$
0:1	$V_{LVW1} = 2.92 \text{ V}$	
1:0	$V_{LVW2} = 4.3 \text{ V}$	$V_{LVD1} = 4.0 \text{ V}$
1:1	$V_{LVW3} = 4.6 \text{ V}$	

¹ See [Appendix A](#), "Electrical Characteristics" for minimum and maximum values.

Chapter 6

Parallel Input/Output Control

This section explains software controls related to parallel input/output (I/O) and pin control. The MC9S08DZ128 Series has up to 11 parallel I/O ports which include a total of up to 87 I/O pins and one input-only pin. See [Chapter 2, “Pins and Connections,”](#) for more information about pin assignments and external hardware considerations of these pins.

Many of these pins are shared with on-chip peripherals such as timer systems, communication systems, or pin interrupts as shown in [Table 2-1](#). The peripheral modules have priority over the general-purpose I/O functions so that when a peripheral is enabled, the I/O functions associated with the shared pins are disabled.

After reset, the shared peripheral functions are disabled and the pins are configured as inputs ($PTxDDn = 0$). The pin control functions for each pin are configured as follows: slew rate control enabled ($PTxSEn = 1$), low drive strength selected ($PTxDSn = 0$), and internal pull-ups disabled ($PTxPEn = 0$).

NOTE

Not all general-purpose I/O pins are available on all packages. To avoid extra current drain from floating input pins, the user's reset initialization routine in the application program must either enable on-chip pull-up devices or change the direction of unconnected pins to outputs so the pins do not float.

6.1 Port Data and Data Direction

Reading and writing of parallel I/Os are performed through the port data registers. The direction, either input or output, is controlled through the port data direction registers. The parallel I/O port function for an individual pin is illustrated in the block diagram shown in [Figure 6-1](#).

The data direction control bit ($PTxDDn$) determines whether the output buffer for the associated pin is enabled, and also controls the source for port data register reads. The input buffer for the associated pin is always enabled unless the pin is enabled as an analog function or is an output-only pin.

When a shared digital function is enabled for a pin, the output buffer is controlled by the shared function. However, the data direction register bit will continue to control the source for reads of the port data register.

When a shared analog function is enabled for a pin, both the input and output buffers are disabled. A value of 0 is read for any port data bit where the bit is an input ($PTxDDn = 0$) and the input buffer is disabled. In general, whenever a pin is shared with both an alternate digital function and an analog function, the analog function has priority such that if both the digital and analog functions are enabled, the analog function controls the pin.

It is a good programming practice to write to the port data register before changing the direction of a port pin to become an output. This ensures that the pin will not be driven momentarily with an old data value that happened to be in the port data register.

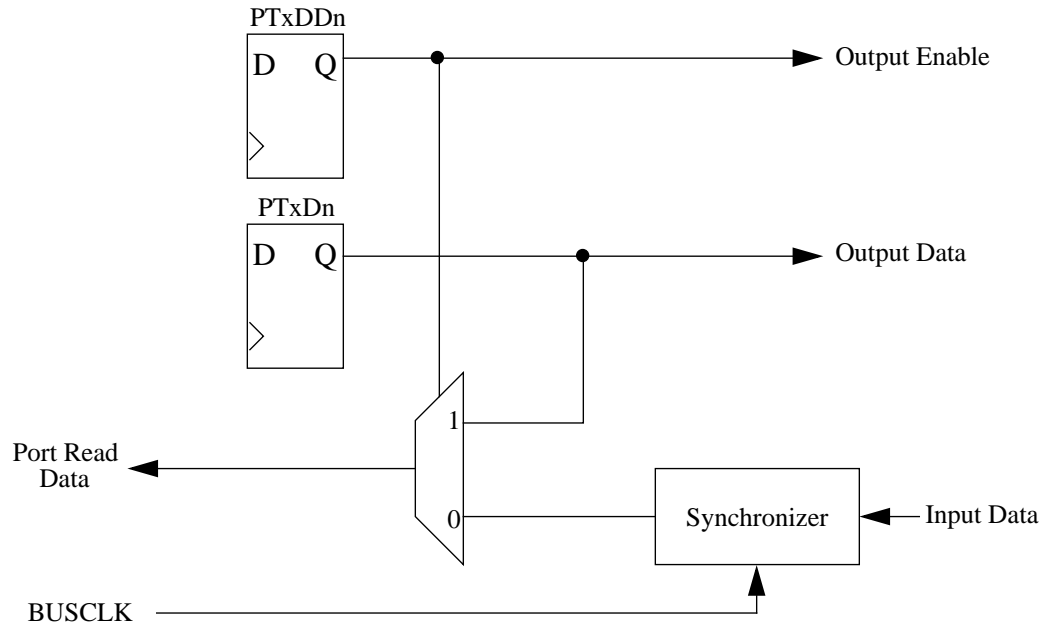

Figure 6-1. Parallel I/O Block Diagram

6.2 Pull-up, Slew Rate, and Drive Strength

Associated with the parallel I/O ports is a set of registers located in the high page register space that operate independently of the parallel I/O registers. These registers are used to control pull-ups, slew rate, and drive strength for the pins.

An internal pull-up device can be enabled for each port pin by setting the corresponding bit in the pull-up enable register (PTxPEN). The pull-up device is disabled if the pin is configured as an output by the parallel I/O control logic or any shared peripheral function regardless of the state of the corresponding pull-up enable register bit. The pull-up device is also disabled if the pin is controlled by an analog function.

Slew rate control can be enabled for each port pin by setting the corresponding bit in the slew rate control register (PTxSEN). When enabled, slew control limits the rate at which an output can transition in order to reduce EMC emissions. Slew rate control has no effect on pins that are configured as inputs.

NOTE

Slew rate reset default values may differ between engineering samples and final production parts. Always initialize slew rate control to the desired value to ensure correct operation.

An output pin can be selected to have high output drive strength by setting the corresponding bit in the drive strength select register (PTxDSn). When high drive is selected, a pin is capable of sourcing and sinking greater current. Even though every I/O pin can be selected as high drive, the user must ensure that the total current source and sink limits for the MCU are not exceeded. Drive strength selection is intended to affect the DC behavior of I/O pins. However, the AC behavior is also affected. High drive allows a pin

to drive a greater load with the same switching speed as a low drive enabled pin into a smaller load. Because of this, the EMC emissions may be affected by enabling pins as high drive.

6.3 Pin Interrupts

Port A, port B, port D, and port J pins can be configured as external interrupt inputs and as an external means of waking the MCU from stop or wait low-power modes.

The block diagram for each port interrupt logic is shown [Figure 6-2](#).

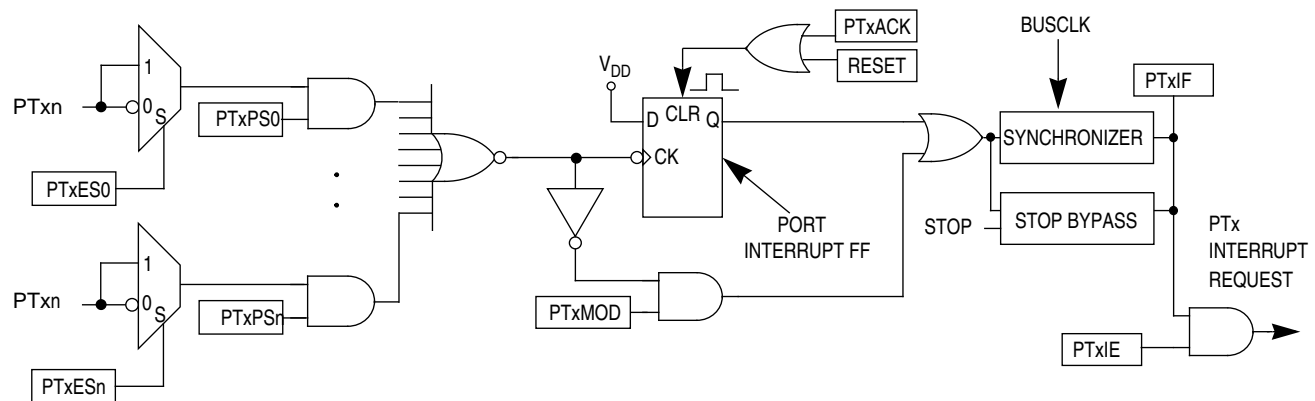

Figure 6-2. Port Interrupt Block Diagram

Writing to the PTxPSn bits in the port interrupt pin select register (PTxPS) independently enables or disables each port pin. Each port can be configured as edge sensitive or edge and level sensitive based on the PTxMOD bit in the port interrupt status and control register (PTxSC). Edge sensitivity can be software programmed to be either falling or rising; the level can be either low or high. The polarity of the edge or edge and level sensitivity is selected using the PTxESn bits in the port interrupt edge select register (PTxES).

Synchronous logic is used to detect edges. Prior to detecting an edge, enabled port inputs must be at the deasserted logic level. A falling edge is detected when an enabled port input signal is seen as a logic 1 (the deasserted level) during one bus cycle and then a logic 0 (the asserted level) during the next cycle. A rising edge is detected when the input signal is seen as a logic 0 during one bus cycle and then a logic 1 during the next cycle.

6.3.1 Edge Only Sensitivity

A valid rising or falling edge on an enabled port pin will set PTxIF in PTxSC. If PTxIE in PTxSC is set, an interrupt request will be presented to the CPU. Clearing of PTxIF is accomplished by writing a 1 to PTxACK in PTxSC.

6.3.2 Edge and Level Sensitivity

A valid edge or level on an enabled port pin will set PTxIF in PTxSC. If PTxIE in PTxSC is set, an interrupt request will be presented to the CPU. Clearing of PTxIF is accomplished by writing a 1 to PTxACK in

PTxSC provided all enabled port inputs are at their deasserted levels. PTxIF will remain set if any enabled port pin is asserted while attempting to clear by writing a 1 to PTxACK.

6.3.3 Pull-up/Pull-down Resistors

The port interrupt pins can be configured to use an internal pull-up/pull-down resistor using the associated I/O port pull-up enable register. If an internal resistor is enabled, the PTxES register is used to select whether the resistor is a pull-up (PTxESn = 0) or a pull-down (PTxESn = 1).

6.3.4 Pin Interrupt Initialization

When an interrupt pin is first enabled, it is possible to get a false interrupt flag. To prevent a false interrupt request during pin interrupt initialization, the user should do the following:

1. Mask interrupts by clearing PTxIE in PTxSC.
2. Select the pin polarity by setting the appropriate PTxESn bits in PTxES.
3. If using internal pull-up/pull-down device, configure the associated pull enable bits in PTxPE.
4. Enable the interrupt pins by setting the appropriate PTxPSn bits in PTxPS.
5. Write to PTxACK in PTxSC to clear any false interrupts.
6. Set PTxIE in PTxSC to enable interrupts.

6.4 Pin Behavior in Stop Modes

Pin behavior following execution of a STOP instruction depends on the stop mode that is entered. An explanation of pin behavior for the various stop modes follows:

- Stop2 mode is a partial power-down mode, whereby I/O latches are maintained in their state as before the STOP instruction was executed. CPU register status and the state of I/O registers should be saved in RAM before the STOP instruction is executed to place the MCU in stop2 mode. Upon recovery from stop2 mode, before accessing any I/O, the user should examine the state of the PPDF bit in the SPMSC2 register. If the PPDF bit is 0, I/O must be initialized as if a power on reset had occurred. If the PPDF bit is 1, peripherals may require initialization to be restored to their pre-stop condition. This can be done using data previously stored in RAM if it was saved before the STOP instruction was executed. The user must then write a 1 to the PPDACK bit in the SPMSC2 register. Access to I/O is now permitted again in the user application program.
- In stop3 mode, all I/O is maintained because internal logic circuitry stays powered up. Upon recovery, normal I/O function is available to the user.

6.5 Parallel I/O and Pin Control Registers

This section provides information about the registers associated with the parallel I/O ports. The data and data direction registers are located in page zero of the memory map. The pull up, slew rate, drive strength, and interrupt control registers are located in the high page section of the memory map.

Refer to tables in Chapter 4, “Memory,” for the absolute address assignments for all parallel I/O and their pin control registers. This section refers to registers and control bits only by their names. A Freescale

Semiconductor-provided equate or header file normally is used to translate these names into the appropriate absolute addresses.

6.5.1 Port A Registers

Port A is controlled by the registers listed below.

6.5.1.1 Port A Data Register (PTAD)

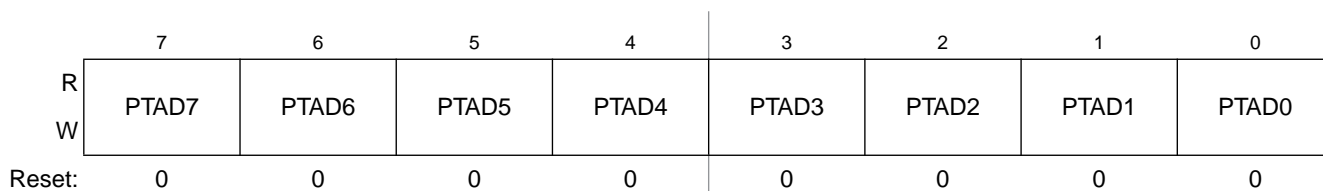

Figure 6-3. Port A Data Register (PTAD)

Table 6-1. PTAD Register Field Descriptions

Field	Description
7:0 PTAD[7:0]	<p>Port A Data Register Bits — For port A pins that are inputs, reads return the logic level on the pin. For port A pins that are configured as outputs, reads return the last value written to this register. Writes are latched into all bits of this register. For port A pins that are configured as outputs, the logic level is driven out the corresponding MCU pin.</p> <p>Reset forces PTAD to all 0s, but these 0s are not driven out the corresponding pins because reset also configures all port pins as high-impedance inputs with pull-ups/pull-downs disabled.</p>

6.5.1.2 Port A Data Direction Register (PTADD)

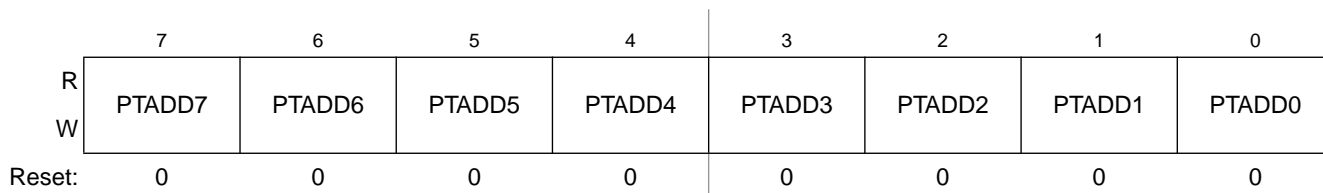

Figure 6-4. Port A Data Direction Register (PTADD)

Table 6-2. PTADD Register Field Descriptions

Field	Description
7:0 PTADD[7:0]	<p>Data Direction for Port A Bits — These read/write bits control the direction of port A pins and what is read for PTAD reads.</p> <p>0 Input (output driver disabled) and reads return the pin value.</p> <p>1 Output driver enabled for port A bit n and PTAD reads return the contents of PTADn.</p>

6.5.1.3 Port A Pull Enable Register (PTAPE)

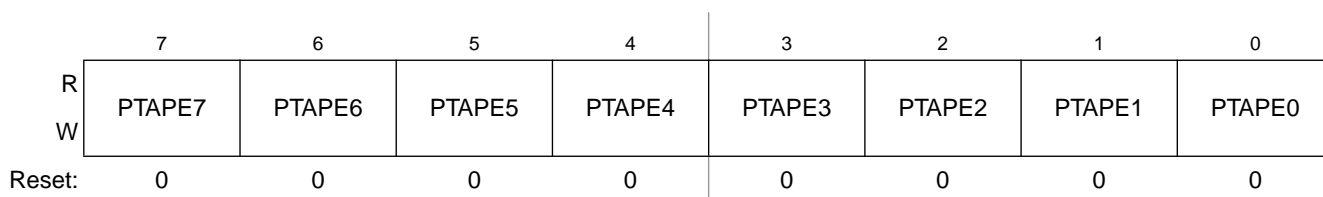

Figure 6-5. Internal Pull Enable for Port A Register (PTAPE)

Table 6-3. PTAPE Register Field Descriptions

Field	Description
7:0 PTAPE[7:0]	<p>Internal Pull Enable for Port A Bits — Each of these control bits determines if the internal pull-up or pull-down device is enabled for the associated PTA pin. For port A pins that are configured as outputs, these bits have no effect and the internal pull devices are disabled.</p> <p>0 Internal pull-up/pull-down device disabled for port A bit n. 1 Internal pull-up/pull-down device enabled for port A bit n.</p>

NOTE

Pull-down devices only apply when using pin interrupt functions, when corresponding edge select and pin select functions are configured.

6.5.1.4 Port A Slew Rate Enable Register (PTASE)

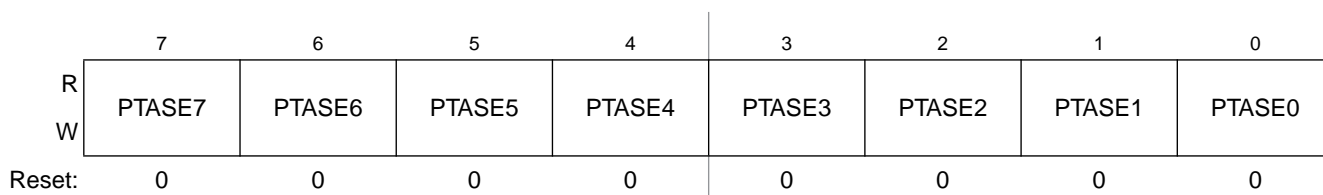

Figure 6-6. Slew Rate Enable for Port A Register (PTASE)

Table 6-4. PTASE Register Field Descriptions

Field	Description
7:0 PTASE[7:0]	<p>Output Slew Rate Enable for Port A Bits — Each of these control bits determines if the output slew rate control is enabled for the associated PTA pin. For port A pins that are configured as inputs, these bits have no effect.</p> <p>0 Output slew rate control disabled for port A bit n. 1 Output slew rate control enabled for port A bit n.</p>

Note: Slew rate reset default values may differ between engineering samples and final production parts. Always initialize slew rate control to the desired value to ensure correct operation.

6.5.1.5 Port A Drive Strength Selection Register (PTADS)

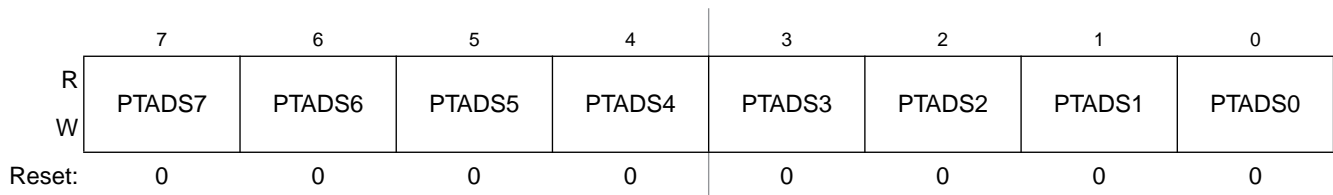

Figure 6-7. Drive Strength Selection for Port A Register (PTADS)

Table 6-5. PTADS Register Field Descriptions

Field	Description
7:0 PTADS[7:0]	<p>Output Drive Strength Selection for Port A Bits — Each of these control bits selects between low and high output drive for the associated PTA pin. For port A pins that are configured as inputs, these bits have no effect.</p> <p>0 Low output drive strength selected for port A bit n. 1 High output drive strength selected for port A bit n.</p>

6.5.1.6 Port A Interrupt Status and Control Register (PTASC)

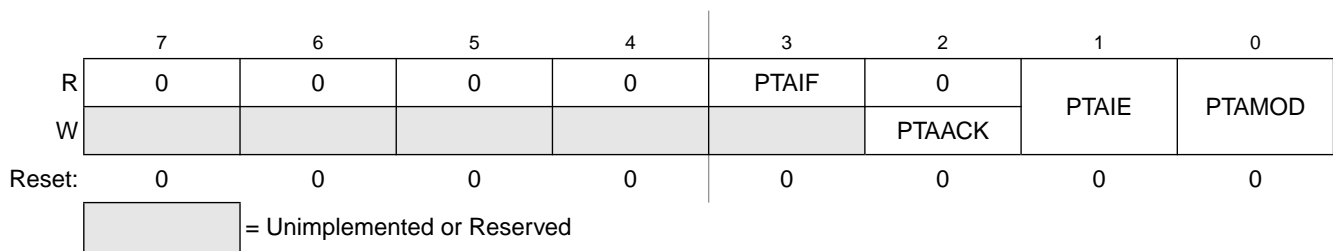

Figure 6-8. Port A Interrupt Status and Control Register (PTASC)

Table 6-6. PTASC Register Field Descriptions

Field	Description
3 PTAIF	<p>Port A Interrupt Flag — PTAIF indicates when a port A interrupt is detected. Writes have no effect on PTAIF.</p> <p>0 No port A interrupt detected. 1 Port A interrupt detected.</p>
2 PTAACK	<p>Port A Interrupt Acknowledge — Writing a 1 to PTAACK is part of the flag clearing mechanism. PTAACK always reads as 0.</p>
1 PTAIE	<p>Port A Interrupt Enable — PTAIE determines whether a port A interrupt is requested.</p> <p>0 Port A interrupt request not enabled. 1 Port A interrupt request enabled.</p>
0 PTAMOD	<p>Port A Detection Mode — PTAMOD (along with the PTAES bits) controls the detection mode of the port A interrupt pins.</p> <p>0 Port A pins detect edges only. 1 Port A pins detect both edges and levels.</p>

6.5.1.7 Port A Interrupt Pin Select Register (PTAPS)

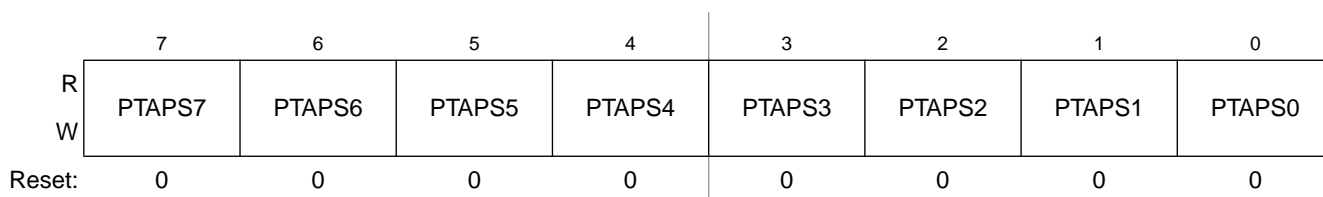

Figure 6-9. Port A Interrupt Pin Select Register (PTAPS)

Table 6-7. PTAPS Register Field Descriptions

Field	Description
7:0 PTAPS[7:0]	Port A Interrupt Pin Selects — Each of the PTAPSn bits enable the corresponding port A interrupt pin. 0 Pin not enabled as interrupt. 1 Pin enabled as interrupt.

6.5.1.8 Port A Interrupt Edge Select Register (PTAES)

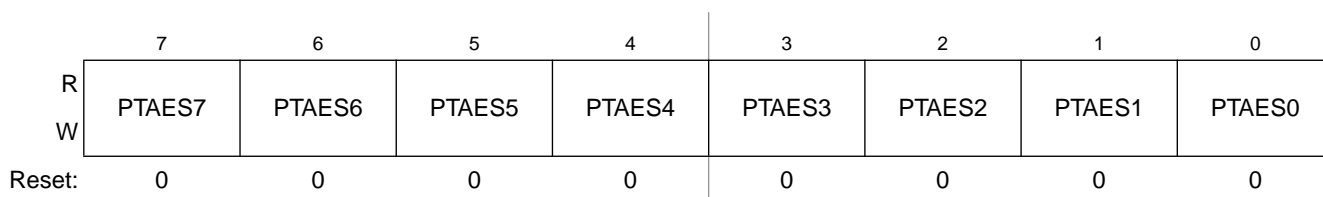

Figure 6-10. Port A Edge Select Register (PTAES)

Table 6-8. PTAES Register Field Descriptions

Field	Description
7:0 PTAES[7:0]	Port A Edge Selects — Each of the PTAESn bits serves a dual purpose by selecting the polarity of the active interrupt edge as well as selecting a pull-up or pull-down device if enabled. 0 A pull-up device is connected to the associated pin and detects falling edge/low level for interrupt generation. 1 A pull-down device is connected to the associated pin and detects rising edge/high level for interrupt generation.

6.5.2 Port B Registers

Port B is controlled by the registers listed below.

6.5.2.1 Port B Data Register (PTBD)

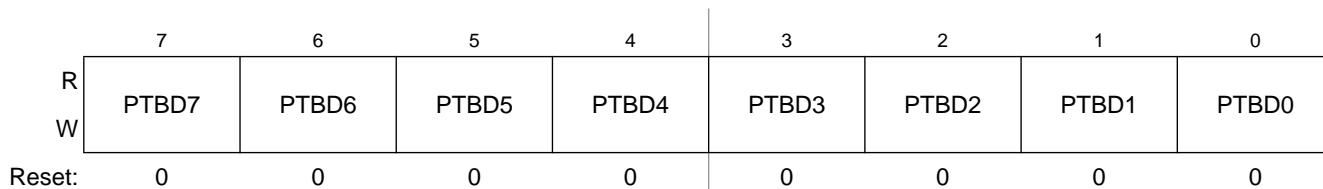

Figure 6-11. Port B Data Register (PTBD)

Table 6-9. PTBD Register Field Descriptions

Field	Description
7:0 PTBD[7:0]	<p>Port B Data Register Bits — For port B pins that are inputs, reads return the logic level on the pin. For port B pins that are configured as outputs, reads return the last value written to this register. Writes are latched into all bits of this register. For port B pins that are configured as outputs, the logic level is driven out the corresponding MCU pin. Reset forces PTBD to all 0s, but these 0s are not driven out the corresponding pins because reset also configures all port pins as high-impedance inputs with pull-ups/pull-downs disabled.</p>

6.5.2.2 Port B Data Direction Register (PTBDD)

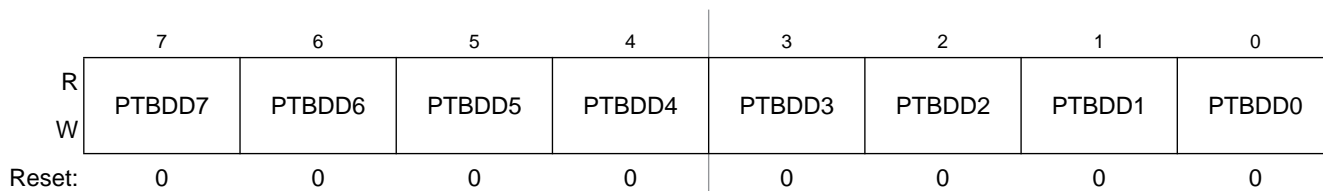

Figure 6-12. Port B Data Direction Register (PTBDD)

Table 6-10. PTBDD Register Field Descriptions

Field	Description
7:0 PTBDD[7:0]	<p>Data Direction for Port B Bits — These read/write bits control the direction of port B pins and what is read for PTBD reads.</p> <p>0 Input (output driver disabled) and reads return the pin value.</p> <p>1 Output driver enabled for port B bit n and PTBD reads return the contents of PTBDn.</p>

6.5.2.3 Port B Pull Enable Register (PTBPE)

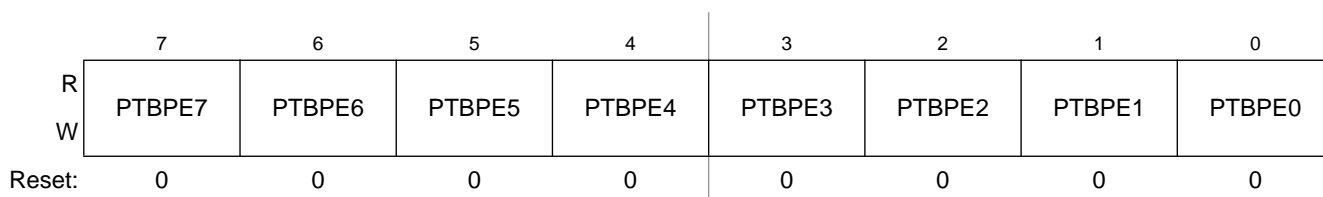

Figure 6-13. Internal Pull Enable for Port B Register (PTBPE)

Table 6-11. PTBPE Register Field Descriptions

Field	Description
7:0 PTBPE[7:0]	<p>Internal Pull Enable for Port B Bits — Each of these control bits determines if the internal pull-up or pull-down device is enabled for the associated PTB pin. For port B pins that are configured as outputs, these bits have no effect and the internal pull devices are disabled.</p> <p>0 Internal pull-up/pull-down device disabled for port B bit n. 1 Internal pull-up/pull-down device enabled for port B bit n.</p>

NOTE

Pull-down devices only apply when using pin interrupt functions, when corresponding edge select and pin select functions are configured.

6.5.2.4 Port B Slew Rate Enable Register (PTBSE)

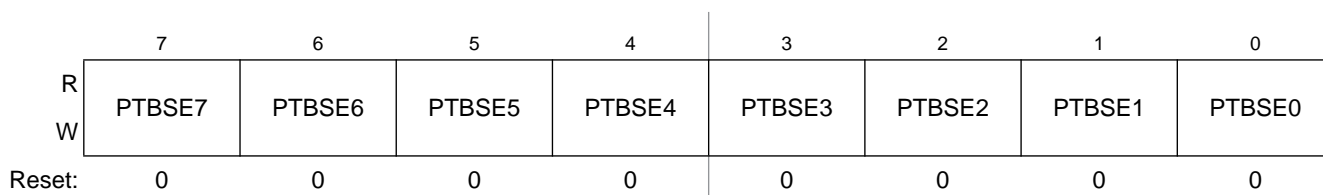

Figure 6-14. Slew Rate Enable for Port B Register (PTBSE)

Table 6-12. PTBSE Register Field Descriptions

Field	Description
7:0 PTBSE[7:0]	<p>Output Slew Rate Enable for Port B Bits — Each of these control bits determines if the output slew rate control is enabled for the associated PTB pin. For port B pins that are configured as inputs, these bits have no effect.</p> <p>0 Output slew rate control disabled for port B bit n. 1 Output slew rate control enabled for port B bit n.</p>

Note: Slew rate reset default values may differ between engineering samples and final production parts. Always initialize slew rate control to the desired value to ensure correct operation.

6.5.2.5 Port B Drive Strength Selection Register (PTBDS)

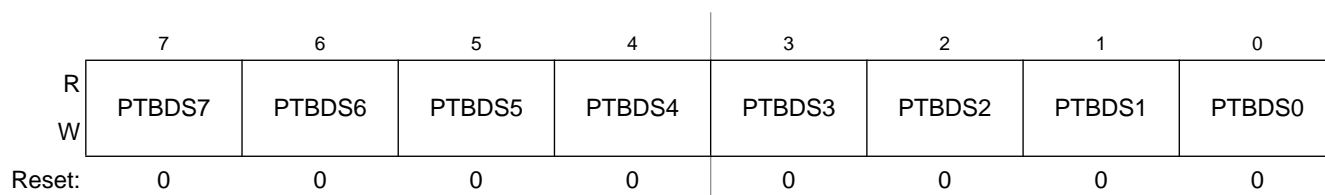

Figure 6-15. Drive Strength Selection for Port B Register (PTBDS)

Table 6-13. PTBDS Register Field Descriptions

Field	Description
7:0 PTBDS[7:0]	Output Drive Strength Selection for Port B Bits — Each of these control bits selects between low and high output drive for the associated PTB pin. For port B pins that are configured as inputs, these bits have no effect. 0 Low output drive strength selected for port B bit n. 1 High output drive strength selected for port B bit n.

6.5.2.6 Port B Interrupt Status and Control Register (PTBSC)

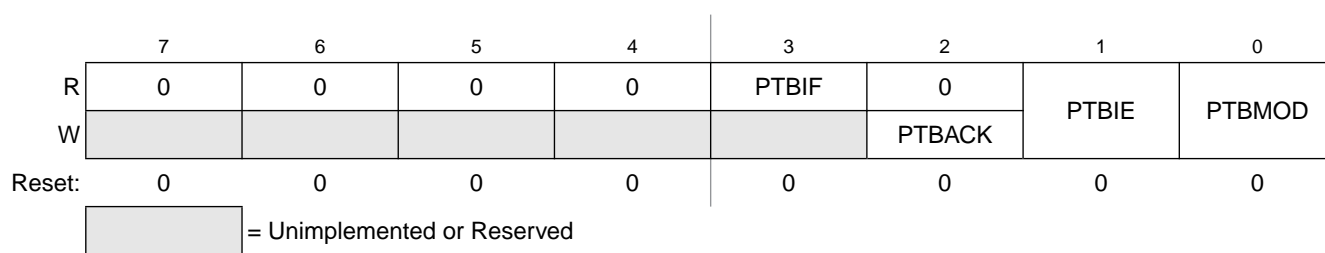

Figure 6-16. Port B Interrupt Status and Control Register (PTBSC)

Table 6-14. PTBSC Register Field Descriptions

Field	Description
3 PTBIF	Port B Interrupt Flag — PTBIF indicates when a Port B interrupt is detected. Writes have no effect on PTBIF. 0 No Port B interrupt detected. 1 Port B interrupt detected.
2 PTBACK	Port B Interrupt Acknowledge — Writing a 1 to PTBACK is part of the flag clearing mechanism. PTBACK always reads as 0.
1 PTBIE	Port B Interrupt Enable — PTBIE determines whether a port B interrupt is requested. 0 Port B interrupt request not enabled. 1 Port B interrupt request enabled.
0 PTBMOD	Port B Detection Mode — PTBMOD (along with the PTBES bits) controls the detection mode of the port B interrupt pins. 0 Port B pins detect edges only. 1 Port B pins detect both edges and levels.

6.5.2.7 Port B Interrupt Pin Select Register (PTBPS)

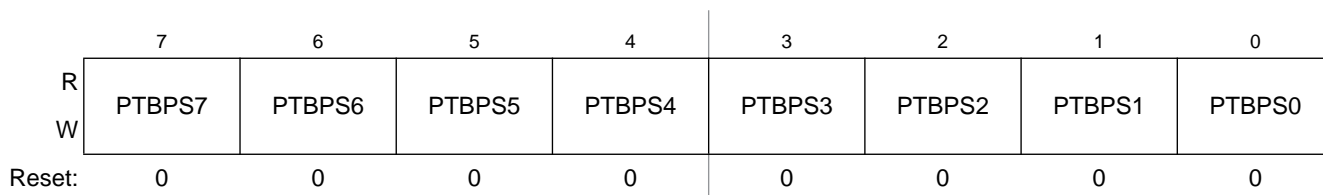

Figure 6-17. Port B Interrupt Pin Select Register (PTBPS)

Table 6-15. PTBPS Register Field Descriptions

Field	Description
7:0 PTBPS[7:0]	Port B Interrupt Pin Selects — Each of the PTBPSn bits enable the corresponding port B interrupt pin. 0 Pin not enabled as interrupt. 1 Pin enabled as interrupt.

6.5.2.8 Port B Interrupt Edge Select Register (PTBES)

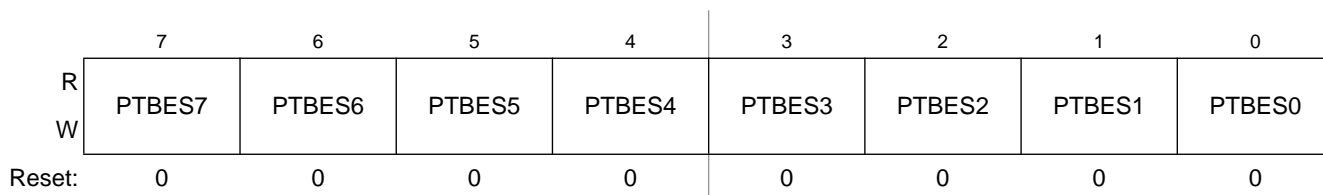

Figure 6-18. Port B Edge Select Register (PTBES)

Table 6-16. PTBES Register Field Descriptions

Field	Description
7:0 PTBES[7:0]	Port B Edge Selects — Each of the PTBESn bits serves a dual purpose by selecting the polarity of the active interrupt edge as well as selecting a pull-up or pull-down device if enabled. 0 A pull-up device is connected to the associated pin and detects falling edge/low level for interrupt generation. 1 A pull-down device is connected to the associated pin and detects rising edge/high level for interrupt generation.

6.5.3 Port C Registers

Port C is controlled by the registers listed below.

6.5.3.1 Port C Data Register (PTCD)

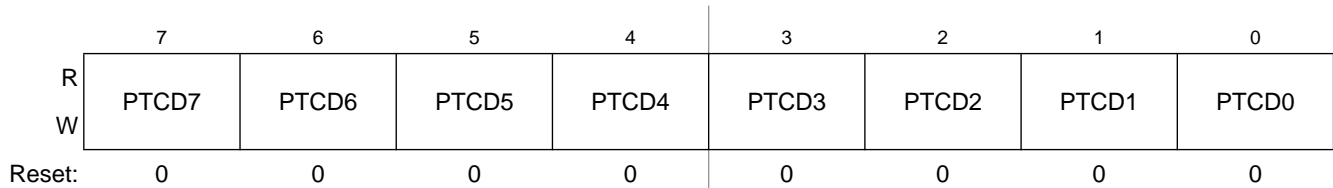

Figure 6-19. Port C Data Register (PTCD)

Table 6-17. PTCD Register Field Descriptions

Field	Description
7:0 PTCD[7:0]	<p>Port C Data Register Bits — For port C pins that are inputs, reads return the logic level on the pin. For port C pins that are configured as outputs, reads return the last value written to this register. Writes are latched into all bits of this register. For port C pins that are configured as outputs, the logic level is driven out the corresponding MCU pin. Reset forces PTCD to all 0s, but these 0s are not driven out the corresponding pins because reset also configures all port pins as high-impedance inputs with pull-ups disabled.</p>

6.5.3.2 Port C Data Direction Register (PTCDD)

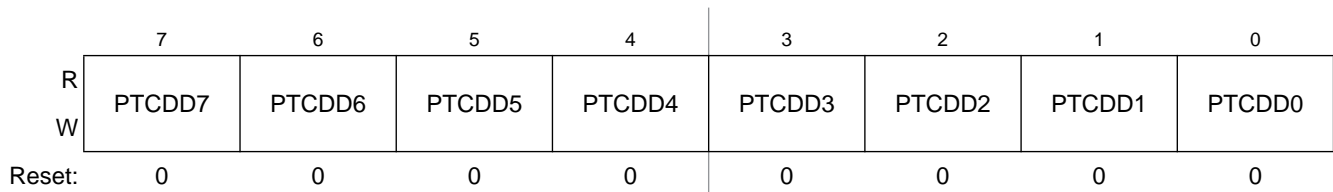

Figure 6-20. Port C Data Direction Register (PTCDD)

Table 6-18. PTCDD Register Field Descriptions

Field	Description
7:0 PTCDD[7:0]	<p>Data Direction for Port C Bits — These read/write bits control the direction of port C pins and what is read for PTCD reads.</p> <p>0 Input (output driver disabled) and reads return the pin value.</p> <p>1 Output driver enabled for port C bit n and PTCD reads return the contents of PTCDn.</p>

6.5.3.3 Port C Pull Enable Register (PTCPE)

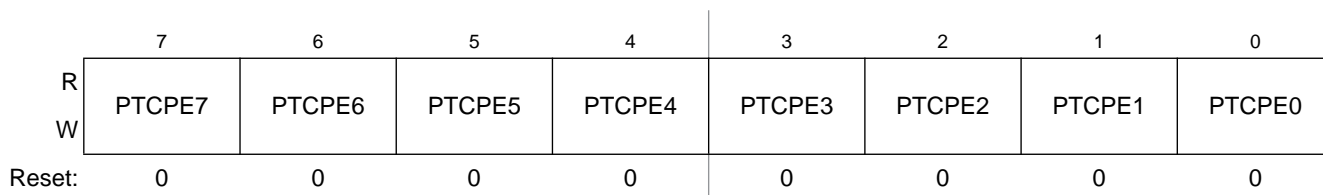

Figure 6-21. Internal Pull Enable for Port C Register (PTCPE)

Table 6-19. PTCPE Register Field Descriptions

Field	Description
7:0 PTCPE[7:0]	<p>Internal Pull Enable for Port C Bits — Each of these control bits determines if the internal pull-up device is enabled for the associated PTC pin. For port C pins that are configured as outputs, these bits have no effect and the internal pull devices are disabled.</p> <p>0 Internal pull-up device disabled for port C bit n. 1 Internal pull-up device enabled for port C bit n.</p>

NOTE

Pull-down devices only apply when using pin interrupt functions, when corresponding edge select and pin select functions are configured.

6.5.3.4 Port C Slew Rate Enable Register (PTCSE)

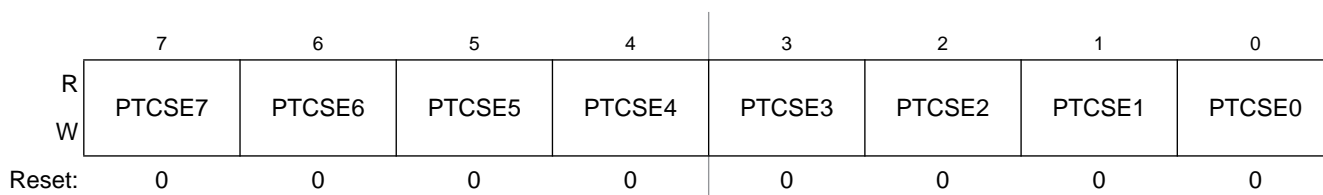

Figure 6-22. Slew Rate Enable for Port C Register (PTCSE)

Table 6-20. PTCSE Register Field Descriptions

Field	Description
7:0 PTCSE[7:0]	<p>Output Slew Rate Enable for Port C Bits — Each of these control bits determines if the output slew rate control is enabled for the associated PTC pin. For port C pins that are configured as inputs, these bits have no effect.</p> <p>0 Output slew rate control disabled for port C bit n. 1 Output slew rate control enabled for port C bit n.</p>

Note: Slew rate reset default values may differ between engineering samples and final production parts. Always initialize slew rate control to the desired value to ensure correct operation.

6.5.3.5 Port C Drive Strength Selection Register (PTCDS)

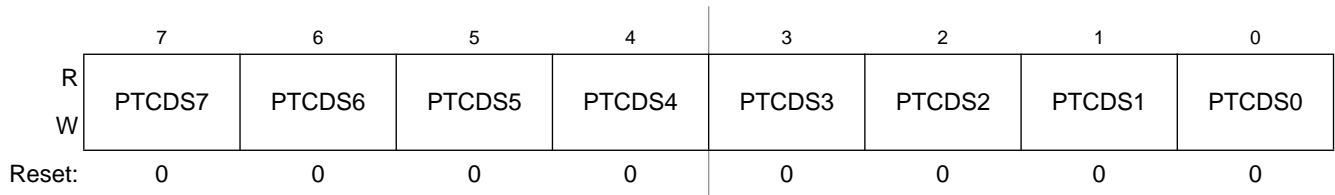

Figure 6-23. Drive Strength Selection for Port C Register (PTCDS)

Table 6-21. PTCDS Register Field Descriptions

Field	Description
7:0 PTCDS[7:0]	<p>Output Drive Strength Selection for Port C Bits — Each of these control bits selects between low and high output drive for the associated PTC pin. For port C pins that are configured as inputs, these bits have no effect.</p> <p>0 Low output drive strength selected for port C bit n.</p> <p>1 High output drive strength selected for port C bit n.</p>

6.5.4 Port D Registers

Port D is controlled by the registers listed below.

6.5.4.1 Port D Data Register (PTDD)

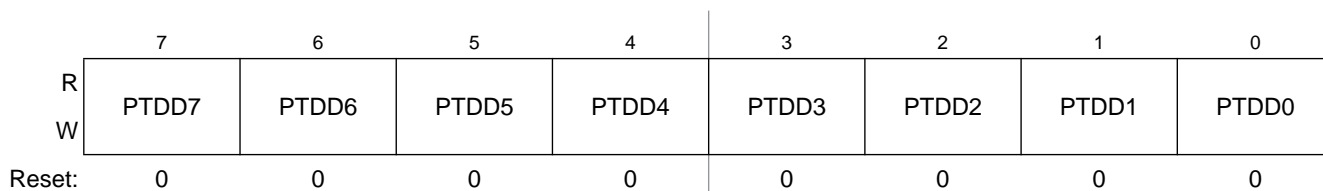

Figure 6-24. Port D Data Register (PTDD)

Table 6-22. PTDD Register Field Descriptions

Field	Description
7:0 PTDD[7:0]	Port D Data Register Bits — For port D pins that are inputs, reads return the logic level on the pin. For port D pins that are configured as outputs, reads return the last value written to this register. Writes are latched into all bits of this register. For port D pins that are configured as outputs, the logic level is driven out the corresponding MCU pin. Reset forces PTDD to all 0s, but these 0s are not driven out the corresponding pins because reset also configures all port pins as high-impedance inputs with pull-ups/pull-downs disabled.

6.5.4.2 Port D Data Direction Register (PTDDD)

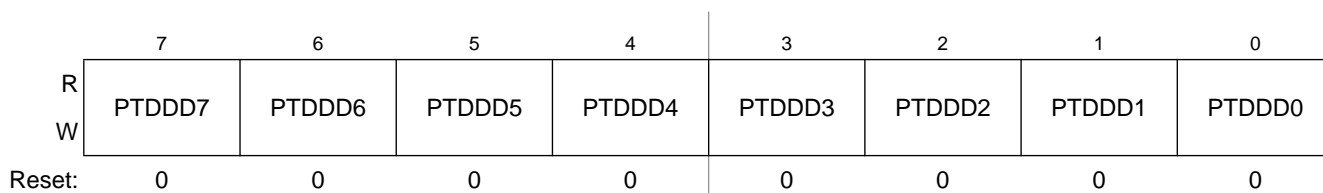

Figure 6-25. Port D Data Direction Register (PTDDD)

Table 6-23. PTDDD Register Field Descriptions

Field	Description
7:0 PTDDD[7:0]	Data Direction for Port D Bits — These read/write bits control the direction of port D pins and what is read for PTDD reads. 0 Input (output driver disabled) and reads return the pin value. 1 Output driver enabled for port D bit n and PTDD reads return the contents of PTDDn.

6.5.4.3 Port D Pull Enable Register (PTDPE)

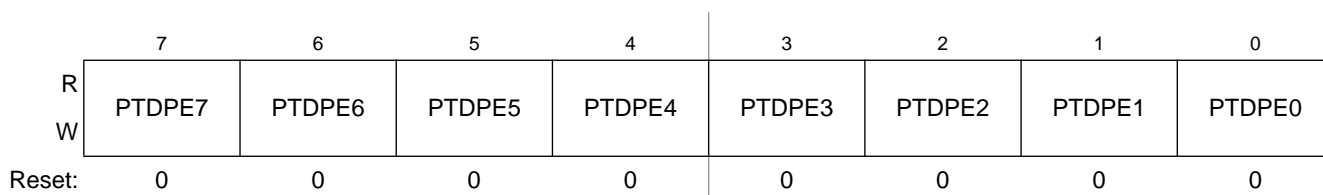

Figure 6-26. Internal Pull Enable for Port D Register (PTDPE)

Table 6-24. PTDPE Register Field Descriptions

Field	Description
7:0 PTDPE[7:0]	Internal Pull Enable for Port D Bits — Each of these control bits determines if the internal pull-up or pull-down device is enabled for the associated PTD pin. For port D pins that are configured as outputs, these bits have no effect and the internal pull devices are disabled. 0 Internal pull-up/pull-down device disabled for port D bit n. 1 Internal pull-up/pull-down device enabled for port D bit n.

NOTE

Pull-down devices only apply when using pin interrupt functions, when corresponding edge select and pin select functions are configured.

6.5.4.4 Port D Slew Rate Enable Register (PTDSE)

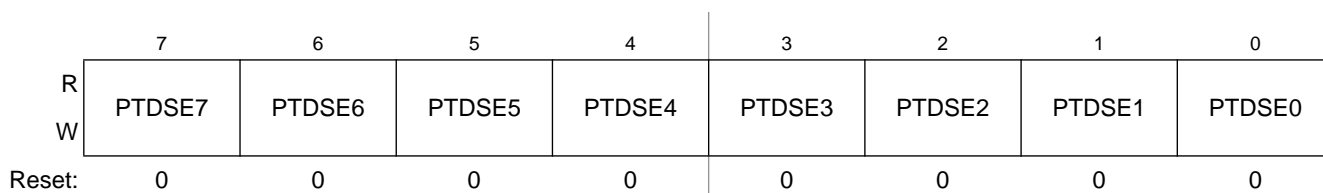

Figure 6-27. Slew Rate Enable for Port D Register (PTDSE)

Table 6-25. PTDSE Register Field Descriptions

Field	Description
7:0 PTDSE[7:0]	Output Slew Rate Enable for Port D Bits — Each of these control bits determines if the output slew rate control is enabled for the associated PTD pin. For port D pins that are configured as inputs, these bits have no effect. 0 Output slew rate control disabled for port D bit n. 1 Output slew rate control enabled for port D bit n.

Note: Slew rate reset default values may differ between engineering samples and final production parts. Always initialize slew rate control to the desired value to ensure correct operation.

6.5.4.5 Port D Drive Strength Selection Register (PTDDS)

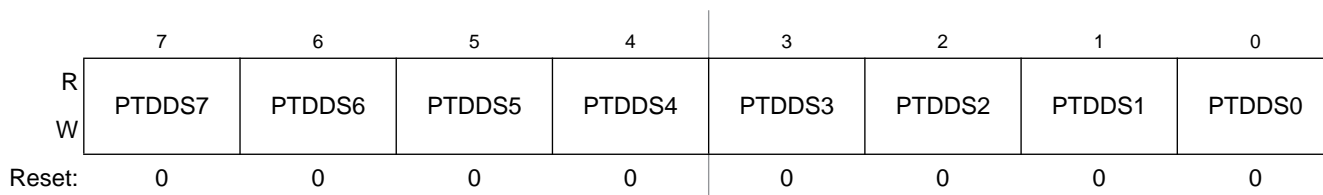

Figure 6-28. Drive Strength Selection for Port D Register (PTDDS)

Table 6-26. PTDDS Register Field Descriptions

Field	Description
7:0 PTDDS[7:0]	<p>Output Drive Strength Selection for Port D Bits — Each of these control bits selects between low and high output drive for the associated PTD pin. For port D pins that are configured as inputs, these bits have no effect.</p> <p>0 Low output drive strength selected for port D bit n. 1 High output drive strength selected for port D bit n.</p>

6.5.4.6 Port D Interrupt Status and Control Register (PTDSC)

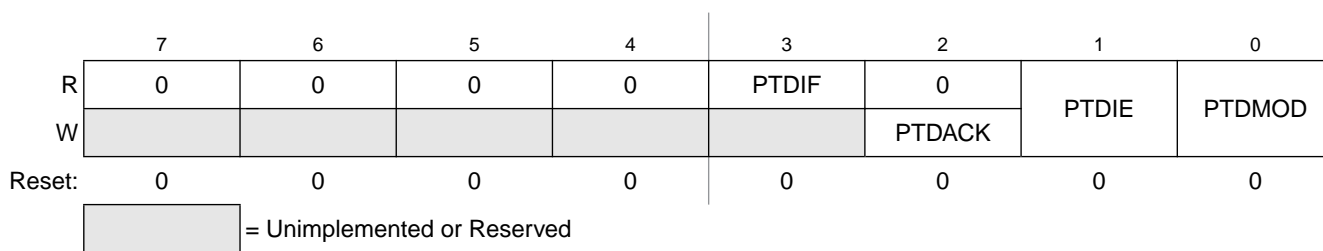

Figure 6-29. Port D Interrupt Status and Control Register (PTDSC)

Table 6-27. PTDSC Register Field Descriptions

Field	Description
3 PTDIF	<p>Port D Interrupt Flag — PTDIF indicates when a port D interrupt is detected. Writes have no effect on PTDIF.</p> <p>0 No port D interrupt detected. 1 Port D interrupt detected.</p>
2 PTDACK	<p>Port D Interrupt Acknowledge — Writing a 1 to PTDACK is part of the flag clearing mechanism. PTDACK always reads as 0.</p>
1 PTDIE	<p>Port D Interrupt Enable — PTDIE determines whether a port D interrupt is requested.</p> <p>0 Port D interrupt request not enabled. 1 Port D interrupt request enabled.</p>
0 PTDMOD	<p>Port D Detection Mode — PTDMOD (along with the PTDES bits) controls the detection mode of the port D interrupt pins.</p> <p>0 Port D pins detect edges only. 1 Port D pins detect both edges and levels.</p>

6.5.4.7 Port D Interrupt Pin Select Register (PTDPS)

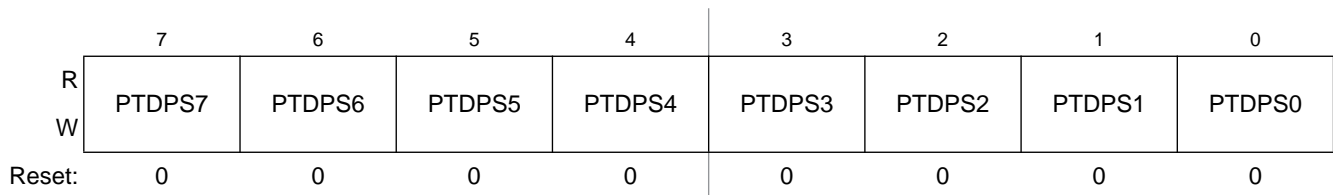

Figure 6-30. Port D Interrupt Pin Select Register (PTDPS)

Table 6-28. PTDPS Register Field Descriptions

Field	Description
7:0 PTDPS[7:0]	Port D Interrupt Pin Selects — Each of the PTDPSn bits enable the corresponding port D interrupt pin. 0 Pin not enabled as interrupt. 1 Pin enabled as interrupt.

6.5.4.8 Port D Interrupt Edge Select Register (PTDES)

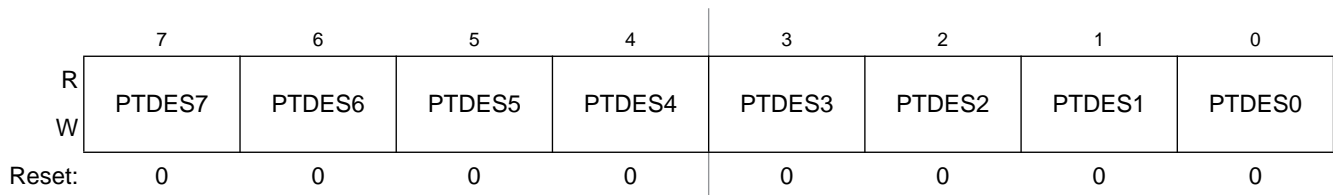

Figure 6-31. Port D Edge Select Register (PTDES)

Table 6-29. PTDES Register Field Descriptions

Field	Description
7:0 PTDES[7:0]	Port D Edge Selects — Each of the PTDESn bits serves a dual purpose by selecting the polarity of the active interrupt edge as well as selecting a pull-up or pull-down device if enabled. 0 A pull-up device is connected to the associated pin and detects falling edge/low level for interrupt generation. 1 A pull-down device is connected to the associated pin and detects rising edge/high level for interrupt generation.

6.5.5 Port E Registers

Port E is controlled by the registers listed below.

6.5.5.1 Port E Data Register (PTED)

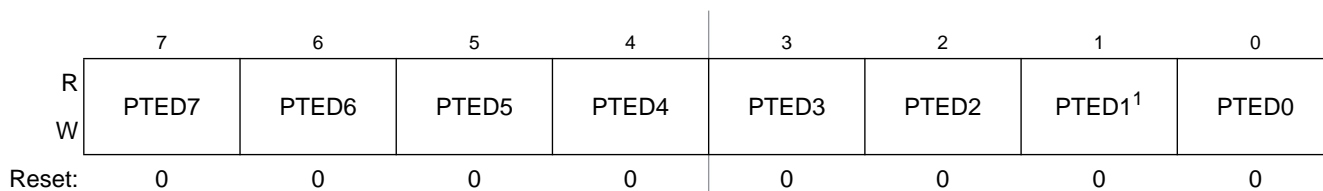

Figure 6-32. Port E Data Register (PTED)

¹ Reads of this bit always return the pin value of the associated pin, regardless of the value stored in the port data direction bit.

Table 6-30. PTED Register Field Descriptions

Field	Description
7:0 PTED[7:0]	<p>Port E Data Register Bits — For port E pins that are inputs, reads return the logic level on the pin. For port E pins that are configured as outputs, reads return the last value written to this register. Writes are latched into all bits of this register. For port E pins that are configured as outputs, the logic level is driven out the corresponding MCU pin. Reset forces PTED to all 0s, but these 0s are not driven out the corresponding pins because reset also configures all port pins as high-impedance inputs with pull-ups disabled.</p>

6.5.5.2 Port E Data Direction Register (PTEDD)

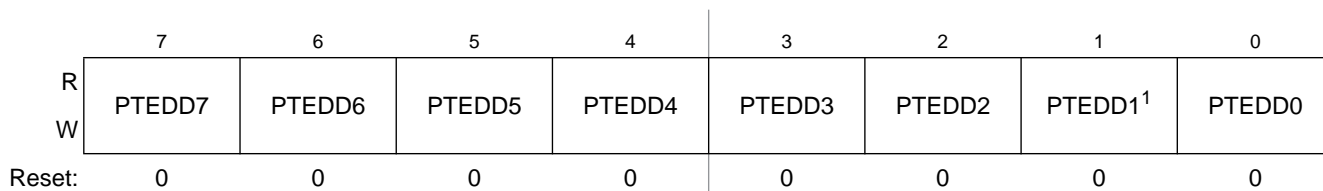

Figure 6-33. Port E Data Direction Register (PTEDD)

¹ PTEDD1 has no effect on the input-only PTE1 pin.

Table 6-31. PTEDD Register Field Descriptions

Field	Description
7:0 PTEDD[7:0]	<p>Data Direction for Port E Bits — These read/write bits control the direction of port E pins and what is read for PTED reads.</p> <p>0 Input (output driver disabled) and reads return the pin value.</p> <p>1 Output driver enabled for port E bit n and PTED reads return the contents of PTEDn.</p>

6.5.5.3 Port E Pull Enable Register (PTEPE)

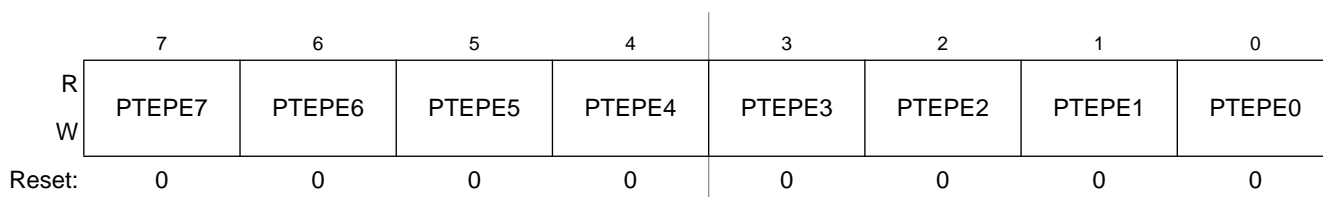

Figure 6-34. Internal Pull Enable for Port E Register (PTEPE)

Table 6-32. PTEPE Register Field Descriptions

Field	Description
7:0 PTEPE[7:0]	Internal Pull Enable for Port E Bits — Each of these control bits determines if the internal pull-up device is enabled for the associated PTE pin. For port E pins that are configured as outputs, these bits have no effect and the internal pull devices are disabled. 0 Internal pull-up device disabled for port E bit n. 1 Internal pull-up device enabled for port E bit n.

NOTE

Pull-down devices only apply when using pin interrupt functions, when corresponding edge select and pin select functions are configured.

6.5.5.4 Port E Slew Rate Enable Register (PTESE)

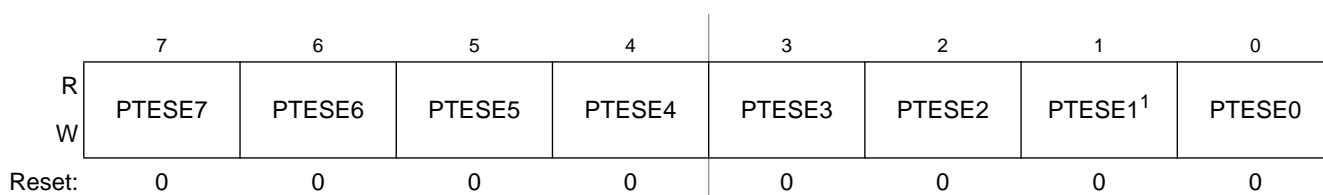

Figure 6-35. Slew Rate Enable for Port E Register (PTESE)

¹ PTESE1 has no effect on the input-only PTE1 pin.

Table 6-33. PTESE Register Field Descriptions

Field	Description
7:0 PTESE[7:0]	Output Slew Rate Enable for Port E Bits — Each of these control bits determines if the output slew rate control is enabled for the associated PTE pin. For port E pins that are configured as inputs, these bits have no effect. 0 Output slew rate control disabled for port E bit n. 1 Output slew rate control enabled for port E bit n.

Note: Slew rate reset default values may differ between engineering samples and final production parts. Always initialize slew rate control to the desired value to ensure correct operation.

6.5.5.5 Port E Drive Strength Selection Register (PTEDS)

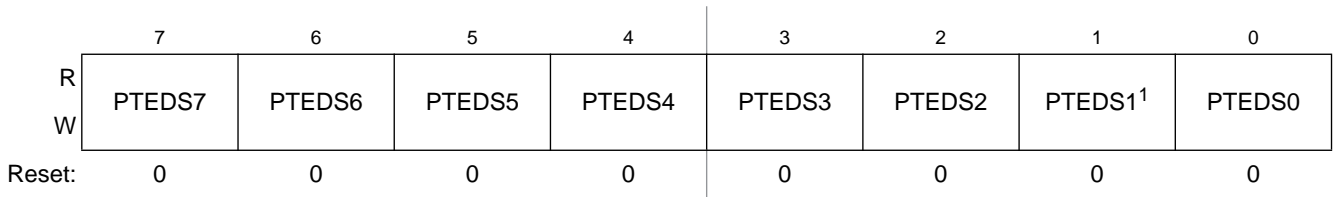

Figure 6-36. Drive Strength Selection for Port E Register (PTEDS)

¹ PTEDS1 has no effect on the input-only PTE1 pin.

Table 6-34. PTEDS Register Field Descriptions

Field	Description
7:0 PTEDS[7:0]	<p>Output Drive Strength Selection for Port E Bits — Each of these control bits selects between low and high output drive for the associated PTE pin. For port E pins that are configured as inputs, these bits have no effect.</p> <p>0 Low output drive strength selected for port E bit n. 1 High output drive strength selected for port E bit n.</p>

6.5.6 Port F Registers

Port F is controlled by the registers listed below.

6.5.6.1 Port F Data Register (PTFD)

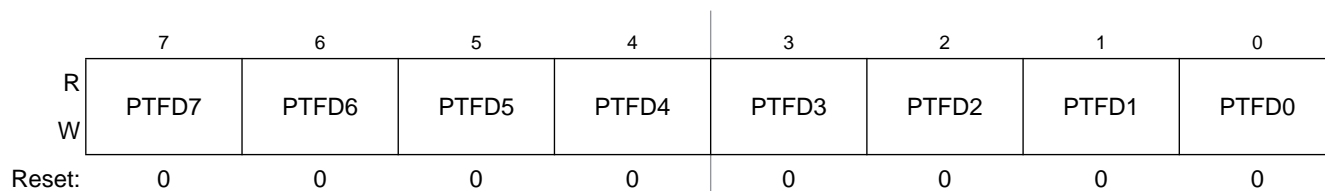

Figure 6-37. Port F Data Register (PTFD)

Table 6-35. PTFD Register Field Descriptions

Field	Description
7:0 PTFD[7:0]	Port F Data Register Bits — For port F pins that are inputs, reads return the logic level on the pin. For port F pins that are configured as outputs, reads return the last value written to this register. Writes are latched into all bits of this register. For port F pins that are configured as outputs, the logic level is driven out the corresponding MCU pin. Reset forces PTFD to all 0s, but these 0s are not driven out the corresponding pins because reset also configures all port pins as high-impedance inputs with pull-ups disabled.

6.5.6.2 Port F Data Direction Register (PTFDD)

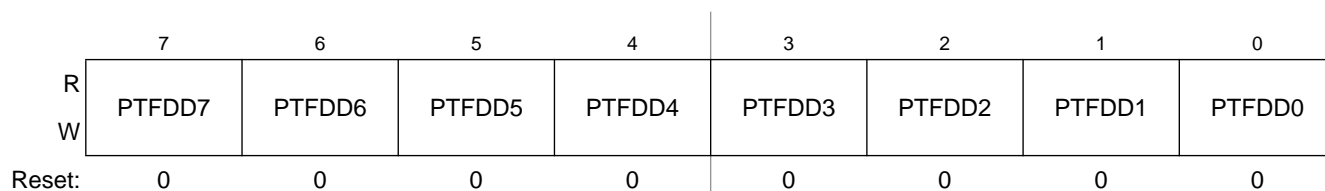

Figure 6-38. Port F Data Direction Register (PTFDD)

Table 6-36. PTFDD Register Field Descriptions

Field	Description
7:0 PTFDD[7:0]	Data Direction for Port F Bits — These read/write bits control the direction of port F pins and what is read for PTFD reads. <ul style="list-style-type: none"> 0 Input (output driver disabled) and reads return the pin value. 1 Output driver enabled for port F bit n and PTFD reads return the contents of PTFDn.

6.5.6.3 Port F Pull Enable Register (PTFPE)

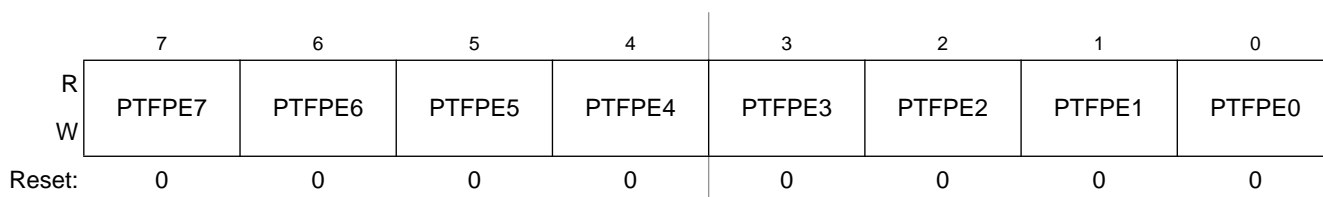

Figure 6-39. Internal Pull Enable for Port F Register (PTFPE)

Table 6-37. PTFPE Register Field Descriptions

Field	Description
7:0 PTFPE[7:0]	<p>Internal Pull Enable for Port F Bits — Each of these control bits determines if the internal pull-up device is enabled for the associated PTF pin. For port F pins that are configured as outputs, these bits have no effect and the internal pull devices are disabled.</p> <p>0 Internal pull-up device disabled for port F bit n. 1 Internal pull-up device enabled for port F bit n.</p>

NOTE

Pull-down devices only apply when using pin interrupt functions, when corresponding edge select and pin select functions are configured.

6.5.6.4 Port F Slew Rate Enable Register (PTFSE)

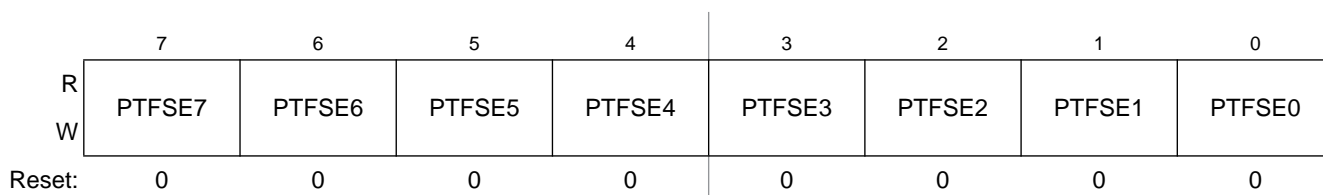

Figure 6-40. Slew Rate Enable for Port F Register (PTFSE)

Table 6-38. PTFSE Register Field Descriptions

Field	Description
7:0 PTFSE[7:0]	<p>Output Slew Rate Enable for Port F Bits — Each of these control bits determines if the output slew rate control is enabled for the associated PTF pin. For port F pins that are configured as inputs, these bits have no effect.</p> <p>0 Output slew rate control disabled for port F bit n. 1 Output slew rate control enabled for port F bit n.</p>

Note: Slew rate reset default values may differ between engineering samples and final production parts. Always initialize slew rate control to the desired value to ensure correct operation.

6.5.6.5 Port F Drive Strength Selection Register (PTFDS)

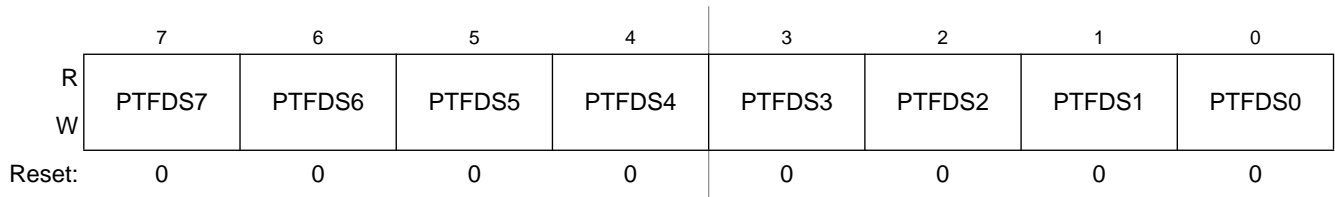

Figure 6-41. Drive Strength Selection for Port F Register (PTFDS)

Table 6-39. PTFDS Register Field Descriptions

Field	Description
7:0 PTFDS[7:0]	<p>Output Drive Strength Selection for Port F Bits — Each of these control bits selects between low and high output drive for the associated PTF pin. For port F pins that are configured as inputs, these bits have no effect.</p> <p>0 Low output drive strength selected for port F bit n.</p> <p>1 High output drive strength selected for port F bit n.</p>

6.5.7 Port G Registers

Port G is controlled by the registers listed below.

6.5.7.1 Port G Data Register (PTGD)

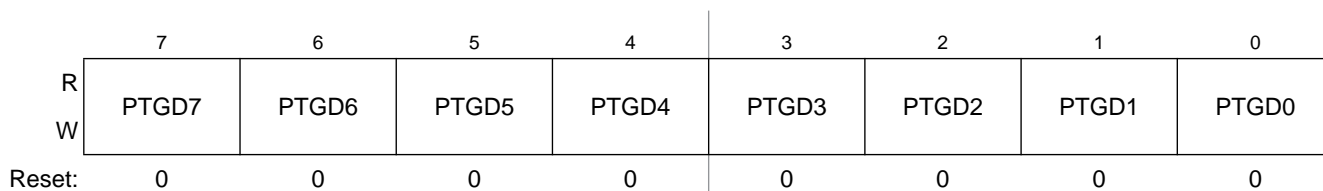

Figure 6-42. Port G Data Register (PTGD)

Table 6-40. PTGD Register Field Descriptions

Field	Description
7:0 PTGD[7:0]	Port G Data Register Bits — For port G pins that are inputs, reads return the logic level on the pin. For port G pins that are configured as outputs, reads return the last value written to this register. Writes are latched into all bits of this register. For port G pins that are configured as outputs, the logic level is driven out the corresponding MCU pin. Reset forces PTGD to all 0s, but these 0s are not driven out the corresponding pins because reset also configures all port pins as high-impedance inputs with pull-ups disabled.

6.5.7.2 Port G Data Direction Register (PTGDD)

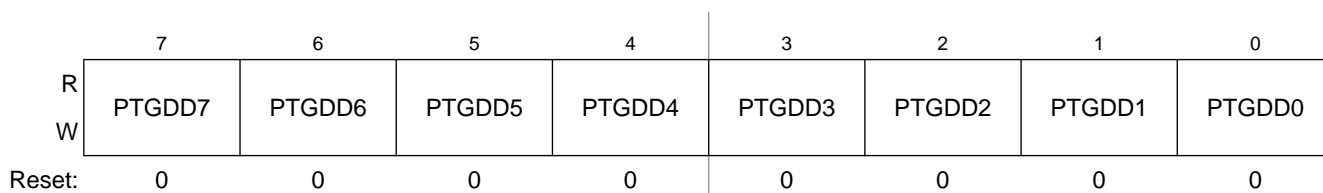

Figure 6-43. Port G Data Direction Register (PTGDD)

Table 6-41. PTGDD Register Field Descriptions

Field	Description
7:0 PTGDD[7:0]	Data Direction for Port G Bits — These read/write bits control the direction of port G pins and what is read for PTGD reads. 0 Input (output driver disabled) and reads return the pin value. 1 Output driver enabled for port G bit n and PTGD reads return the contents of PTGDn.

6.5.7.3 Port G Pull Enable Register (PTGPE)

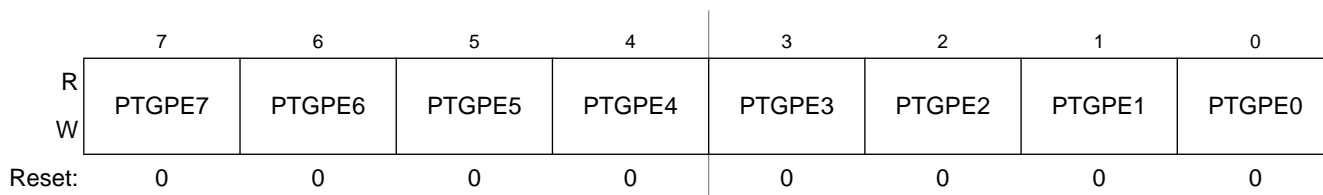

Figure 6-44. Internal Pull Enable for Port G Register (PTGPE)

Table 6-42. PTGPE Register Field Descriptions

Field	Description
7:0 PTGPE[7:0]	<p>Internal Pull Enable for Port G Bits — Each of these control bits determines if the internal pull-up device is enabled for the associated PTG pin. For port G pins that are configured as outputs, these bits have no effect and the internal pull devices are disabled.</p> <p>0 Internal pull-up device disabled for port G bit n. 1 Internal pull-up device enabled for port G bit n.</p>

NOTE

Pull-down devices only apply when using pin interrupt functions, when corresponding edge select and pin select functions are configured.

6.5.7.4 Port G Slew Rate Enable Register (PTGSE)

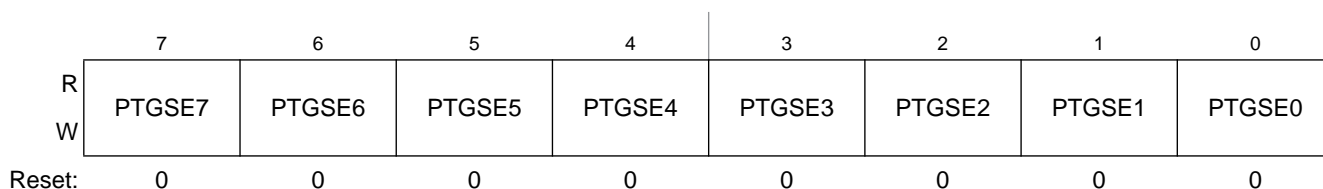

Figure 6-45. Slew Rate Enable for Port G Register (PTGSE)

Table 6-43. PTGSE Register Field Descriptions

Field	Description
7:0 PTGSE[7:0]	<p>Output Slew Rate Enable for Port G Bits — Each of these control bits determines if the output slew rate control is enabled for the associated PTG pin. For port G pins that are configured as inputs, these bits have no effect.</p> <p>0 Output slew rate control disabled for port G bit n. 1 Output slew rate control enabled for port G bit n.</p>

Note: Slew rate reset default values may differ between engineering samples and final production parts. Always initialize slew rate control to the desired value to ensure correct operation.

6.5.7.5 Port G Drive Strength Selection Register (PTGDS)

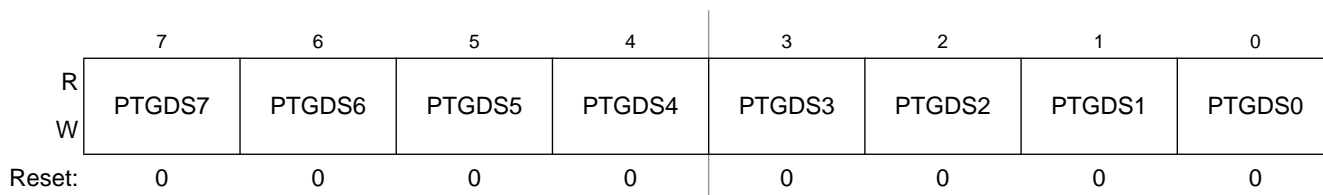

Figure 6-46. Drive Strength Selection for Port G Register (PTGDS)

Table 6-44. PTGDS Register Field Descriptions

Field	Description
7:0 PTGDS[7:0]	<p>Output Drive Strength Selection for Port G Bits — Each of these control bits selects between low and high output drive for the associated PTG pin. For port G pins that are configured as inputs, these bits have no effect.</p> <p>0 Low output drive strength selected for port G bit n.</p> <p>1 High output drive strength selected for port G bit n.</p>

6.5.8 Port H Registers

Port H is controlled by the registers listed below.

6.5.8.1 Port H Data Register (PTHD)

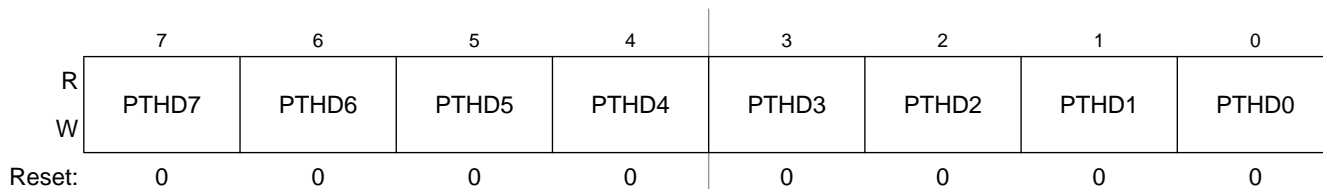

Figure 6-47. Port H Data Register (PTHD)

Table 6-45. PTHD Register Field Descriptions

Field	Description
7:0 PTHD[7:0]	Port H Data Register Bits — For port H pins that are inputs, reads return the logic level on the pin. For port H pins that are configured as outputs, reads return the last value written to this register. Writes are latched into all bits of this register. For port H pins that are configured as outputs, the logic level is driven out the corresponding MCU pin. Reset forces PTHD to all 0s, but these 0s are not driven out the corresponding pins because reset also configures all port pins as high-impedance inputs with pull-ups disabled.

6.5.8.2 Port H Data Direction Register (PTHDD)

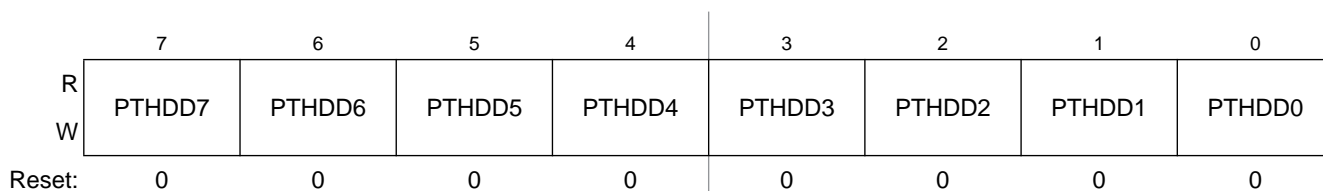

Figure 6-48. Port H Data Direction Register (PTHDD)

Table 6-46. PTHDD Register Field Descriptions

Field	Description
7:0 PTHDD[7:0]	Data Direction for Port H Bits — These read/write bits control the direction of port H pins and what is read for PTHD reads. <ul style="list-style-type: none"> 0 Input (output driver disabled) and reads return the pin value. 1 Output driver enabled for port H bit n and PTHD reads return the contents of PTHDn.

6.5.8.3 Port H Pull Enable Register (PTHPE)

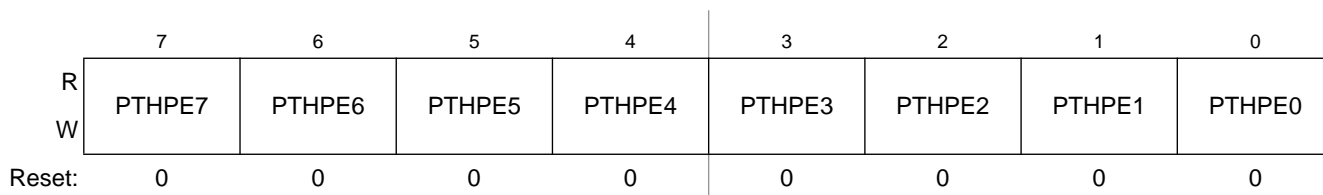

Figure 6-49. Internal Pull Enable for Port H Register (PTHPE)

Table 6-47. PTHPE Register Field Descriptions

Field	Description
7:0 PTHPE[7:0]	<p>Internal Pull Enable for Port H Bits — Each of these control bits determines if the internal pull-up device is enabled for the associated PTH pin. For port H pins that are configured as outputs, these bits have no effect and the internal pull devices are disabled.</p> <p>0 Internal pull-up device disabled for port H bit n. 1 Internal pull-up device enabled for port H bit n.</p>

NOTE

Pull-down devices only apply when using pin interrupt functions, when corresponding edge select and pin select functions are configured.

6.5.8.4 Port H Slew Rate Enable Register (PTHSE)

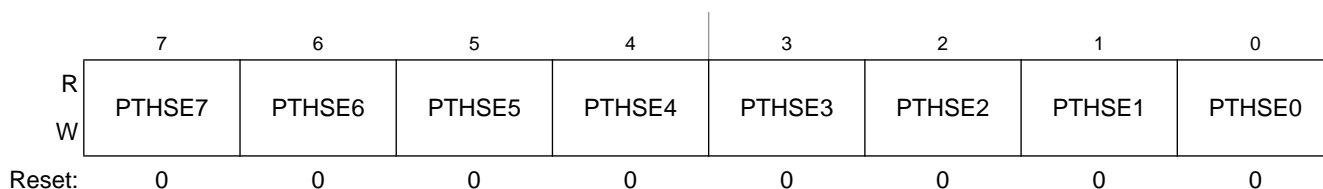

Figure 6-50. Slew Rate Enable for Port H Register (PTHSE)

Table 6-48. PTHSE Register Field Descriptions

Field	Description
7:0 PTHSE[7:0]	<p>Output Slew Rate Enable for Port H Bits — Each of these control bits determines if the output slew rate control is enabled for the associated PTH pin. For port H pins that are configured as inputs, these bits have no effect.</p> <p>0 Output slew rate control disabled for port H bit n. 1 Output slew rate control enabled for port H bit n.</p>

Note: Slew rate reset default values may differ between engineering samples and final production parts. Always initialize slew rate control to the desired value to ensure correct operation.

6.5.8.5 Port H Drive Strength Selection Register (PTHDS)

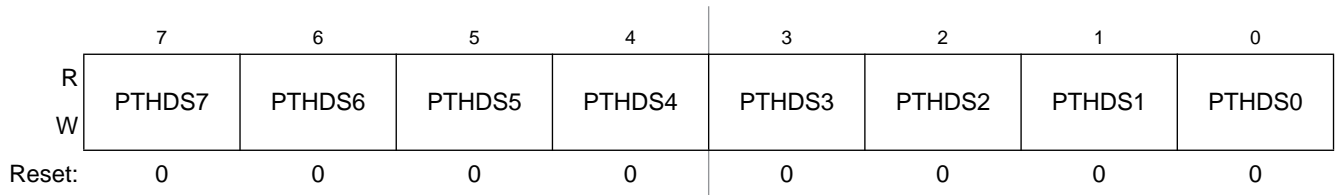

Figure 6-51. Drive Strength Selection for Port H Register (PTHDS)

Table 6-49. PTHDS Register Field Descriptions

Field	Description
7:0 PTHDS[7:0]	<p>Output Drive Strength Selection for Port H Bits — Each of these control bits selects between low and high output drive for the associated PTH pin. For port H pins that are configured as inputs, these bits have no effect.</p> <p>0 Low output drive strength selected for port H bit n.</p> <p>1 High output drive strength selected for port H bit n.</p>

6.5.9 Port J Registers

Port J is controlled by the registers listed below.

6.5.9.1 Port J Data Register (PTJD)

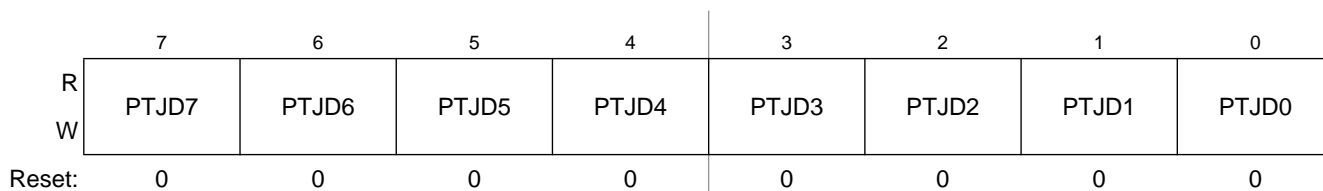

Figure 6-52. Port J Data Register (PTJD)

Table 6-50. PTJD Register Field Descriptions

Field	Description
7:0 PTJD[7:0]	Port J Data Register Bits — For port J pins that are inputs, reads return the logic level on the pin. For port J pins that are configured as outputs, reads return the last value written to this register. Writes are latched into all bits of this register. For port J pins that are configured as outputs, the logic level is driven out the corresponding MCU pin. Reset forces PTJD to all 0s, but these 0s are not driven out the corresponding pins because reset also configures all port pins as high-impedance inputs with pull-ups disabled.

6.5.9.2 Port J Data Direction Register (PTJDD)

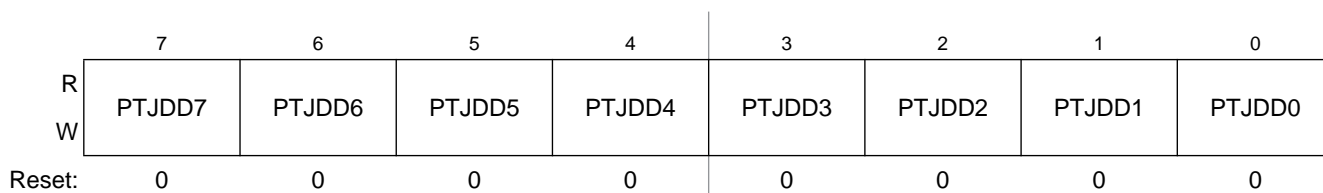

Figure 6-53. Port J Data Direction Register (PTJDD)

Table 6-51. PTJDD Register Field Descriptions

Field	Description
7:0 PTJDD[7:0]	Data Direction for Port J Bits — These read/write bits control the direction of port J pins and what is read for PTJD reads. 0 Input (output driver disabled) and reads return the pin value. 1 Output driver enabled for port J bit n and PTJD reads return the contents of PTJDn.

6.5.9.3 Port J Pull Enable Register (PTJPE)

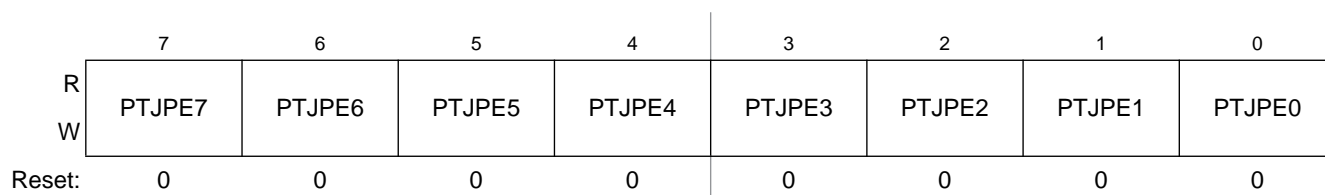

Figure 6-54. Internal Pull Enable for Port J Register (PTJPE)

Table 6-52. PTJPE Register Field Descriptions

Field	Description
7:0 PTJPE[7:0]	Internal Pull Enable for Port J Bits — Each of these control bits determines if the internal pull-up device is enabled for the associated PTJ pin. For port J pins that are configured as outputs, these bits have no effect and the internal pull devices are disabled. 0 Internal pull-up device disabled for port J bit n. 1 Internal pull-up device enabled for port J bit n.

NOTE

Pull-down devices only apply when using pin interrupt functions, when corresponding edge select and pin select functions are configured.

6.5.9.4 Port J Slew Rate Enable Register (PTJSE)

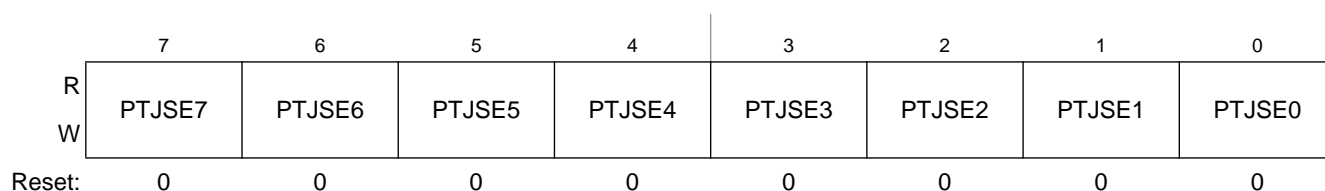

Figure 6-55. Slew Rate Enable for Port J Register (PTJSE)

Table 6-53. PTJSE Register Field Descriptions

Field	Description
7:0 PTJSE[7:0]	Output Slew Rate Enable for Port J Bits — Each of these control bits determines if the output slew rate control is enabled for the associated PTJ pin. For port J pins that are configured as inputs, these bits have no effect. 0 Output slew rate control disabled for port J bit n. 1 Output slew rate control enabled for port J bit n.

Note: Slew rate reset default values may differ between engineering samples and final production parts. Always initialize slew rate control to the desired value to ensure correct operation.

6.5.9.5 Port J Drive Strength Selection Register (PTJDS)

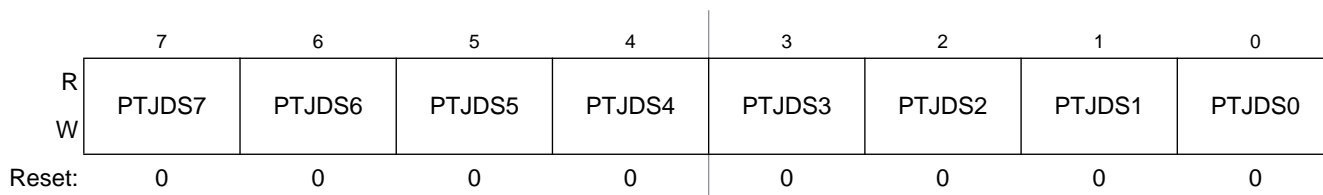

Figure 6-56. Drive Strength Selection for Port J Register (PTJDS)

Table 6-54. PTJDS Register Field Descriptions

Field	Description
7:0 PTJDS[7:0]	Output Drive Strength Selection for Port J Bits — Each of these control bits selects between low and high output drive for the associated PTJ pin. For port J pins that are configured as inputs, these bits have no effect. 0 Low output drive strength selected for port J bit n. 1 High output drive strength selected for port J bit n.

6.5.9.6 Port J Interrupt Status and Control Register (PTJSC)

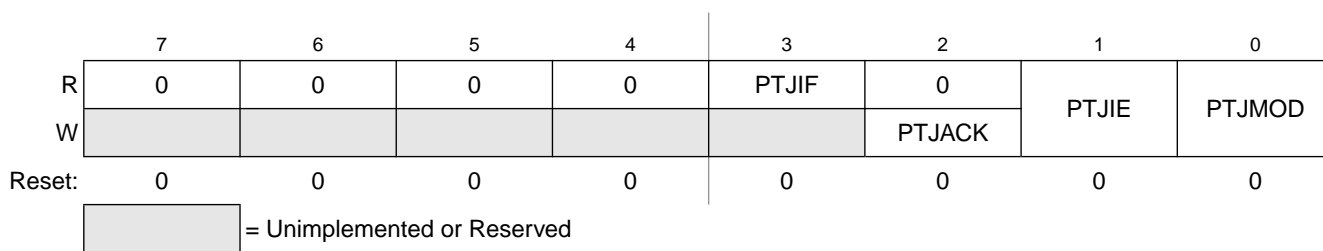

Figure 6-57. Port J Interrupt Status and Control Register (PTJSC)

Table 6-55. PTJSC Register Field Descriptions

Field	Description
3 PTJIF	Port J Interrupt Flag — PTJIF indicates when a port J interrupt is detected. Writes have no effect on PTJIF. 0 No port J interrupt detected. 1 Port J interrupt detected.
2 PTJACK	Port J Interrupt Acknowledge — Writing a 1 to PTJACK is part of the flag clearing mechanism. PTJACK always reads as 0.
1 PTJIE	Port J Interrupt Enable — PTJIE determines whether a port J interrupt is requested. 0 Port J interrupt request not enabled. 1 Port J interrupt request enabled.
0 PTJMOD	Port J Detection Mode — PTJMOD (along with the PTJES bits) controls the detection mode of the port J interrupt pins. 0 Port J pins detect edges only. 1 Port J pins detect both edges and levels.

6.5.9.7 Port J Interrupt Pin Select Register (PTJPS)

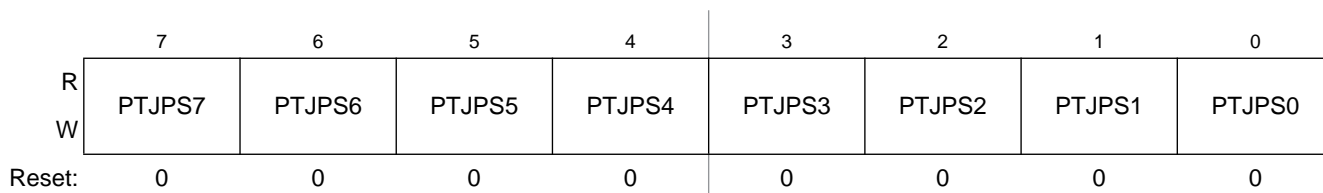

Figure 6-58. Port J Interrupt Pin Select Register (PTJPS)

Table 6-56. PTJPS Register Field Descriptions

Field	Description
7:0 PTJPS[7:0]	Port J Interrupt Pin Selects — Each of the PTJPSn bits enable the corresponding port J interrupt pin. 0 Pin not enabled as interrupt. 1 Pin enabled as interrupt.

6.5.9.8 Port J Interrupt Edge Select Register (PTJES)

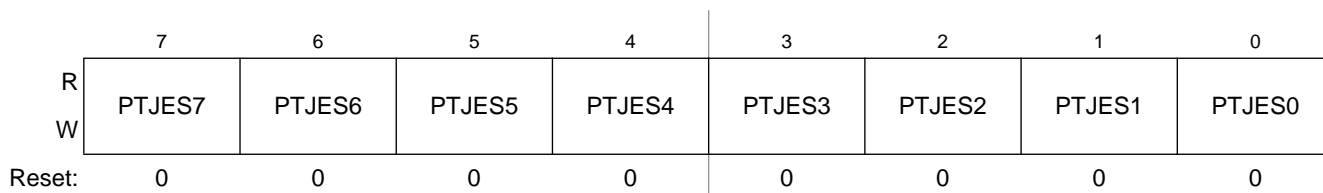

Figure 6-59. Port J Edge Select Register (PTJES)

Table 6-57. PTJES Register Field Descriptions

Field	Description
7:0 PTJES[7:0]	Port J Edge Selects — Each of the PTJESn bits serves a dual purpose by selecting the polarity of the active interrupt edge as well as selecting a pull-up or pull-down device if enabled. 0 A pull-up device is connected to the associated pin and detects falling edge/low level for interrupt generation. 1 A pull-down device is connected to the associated pin and detects rising edge/high level for interrupt generation.

6.5.10 Port K Registers

Port K is controlled by the registers listed below.

6.5.10.1 Port K Data Register (PTKD)

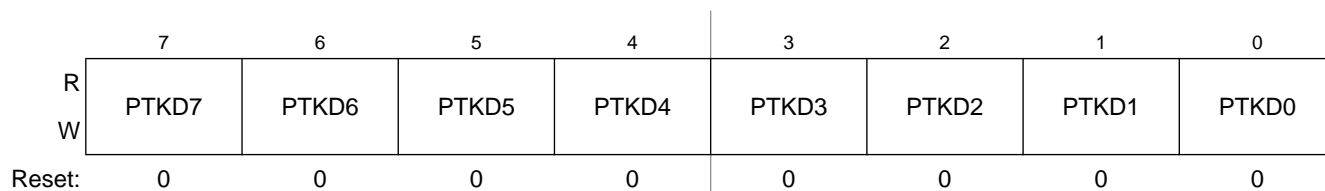

Figure 6-60. Port K Data Register (PTKD)

Table 6-58. PTKD Register Field Descriptions

Field	Description
7:0 PTKD[7:0]	Port K Data Register Bits — For port K pins that are inputs, reads return the logic level on the pin. For port K pins that are configured as outputs, reads return the last value written to this register. Writes are latched into all bits of this register. For port K pins that are configured as outputs, the logic level is driven out the corresponding MCU pin. Reset forces PTKD to all 0s, but these 0s are not driven out the corresponding pins because reset also configures all port pins as high-impedance inputs with pull-ups disabled.

6.5.10.2 Port K Data Direction Register (PTKDD)

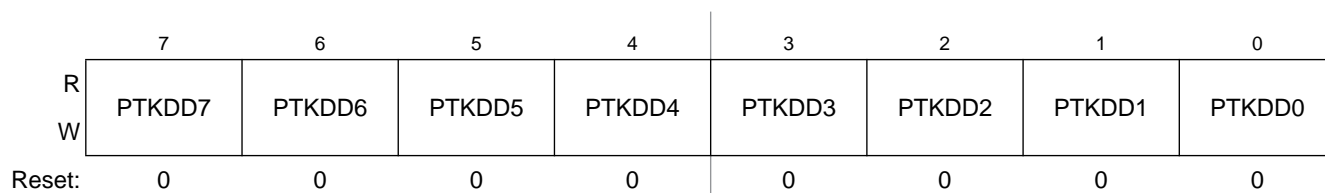

Figure 6-61. Port K Data Direction Register (PTKDD)

Table 6-59. PTKDD Register Field Descriptions

Field	Description
7:0 PTKDD[7:0]	Data Direction for Port K Bits — These read/write bits control the direction of port K pins and what is read for PTKD reads. 0 Input (output driver disabled) and reads return the pin value. 1 Output driver enabled for port K bit n and PTKD reads return the contents of PTKDn.

6.5.10.3 Port K Pull Enable Register (PTKPE)

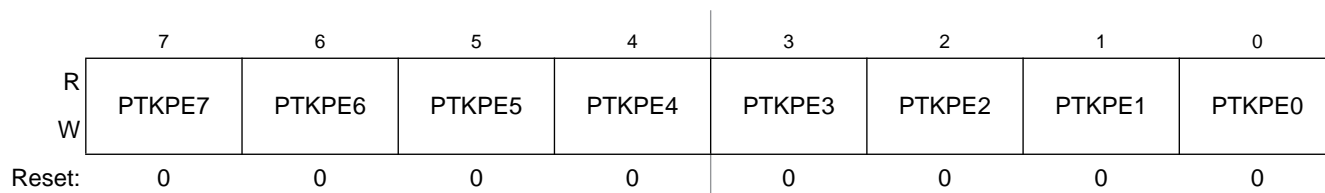

Figure 6-62. Internal Pull Enable for Port K Register (PTKPE)

Table 6-60. PTKPE Register Field Descriptions

Field	Description
7:0 PTKPE[7:0]	Internal Pull Enable for Port K Bits — Each of these control bits determines if the internal pull-up device is enabled for the associated PTK pin. For port K pins that are configured as outputs, these bits have no effect and the internal pull devices are disabled. 0 Internal pull-up device disabled for port K bit n. 1 Internal pull-up device enabled for port K bit n.

NOTE

Pull-down devices only apply when using pin interrupt functions, when corresponding edge select and pin select functions are configured.

6.5.10.4 Port K Slew Rate Enable Register (PTKSE)

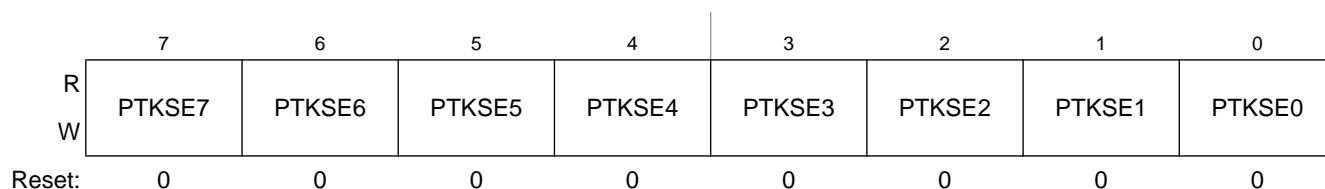

Figure 6-63. Slew Rate Enable for Port K Register (PTKSE)

Table 6-61. PTKSE Register Field Descriptions

Field	Description
7:0 PTKSE[7:0]	Output Slew Rate Enable for Port K Bits — Each of these control bits determines if the output slew rate control is enabled for the associated PTK pin. For port K pins that are configured as inputs, these bits have no effect. 0 Output slew rate control disabled for port K bit n. 1 Output slew rate control enabled for port K bit n.

Note: Slew rate reset default values may differ between engineering samples and final production parts. Always initialize slew rate control to the desired value to ensure correct operation.

6.5.10.5 Port K Drive Strength Selection Register (PTKDS)

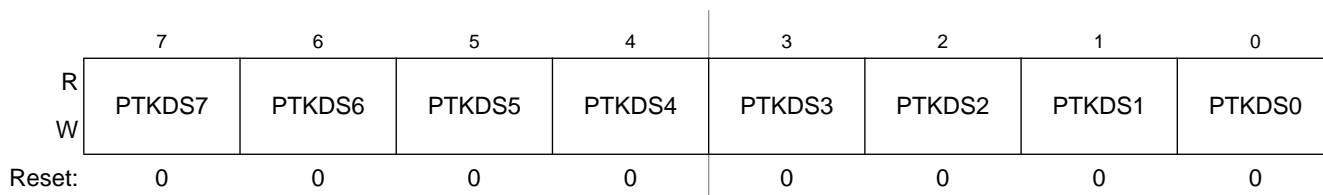

Figure 6-64. Drive Strength Selection for Port K Register (PTKDS)

Table 6-62. PTKDS Register Field Descriptions

Field	Description
7:0 PTKDS[7:0]	<p>Output Drive Strength Selection for Port K Bits — Each of these control bits selects between low and high output drive for the associated PTK pin. For port K pins that are configured as inputs, these bits have no effect.</p> <p>0 Low output drive strength selected for port K bit n.</p> <p>1 High output drive strength selected for port K bit n.</p>

6.5.11 Port L Registers

Port L is controlled by the registers listed below.

6.5.11.1 Port L Data Register (PTLD)

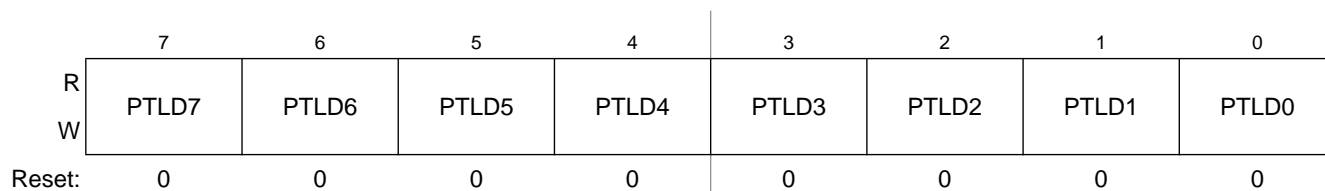

Figure 6-65. Port L Data Register (PTLD)

Table 6-63. PTLD Register Field Descriptions

Field	Description
7:0 PTLD[7:0]	<p>Port L Data Register Bits — For port L pins that are inputs, reads return the logic level on the pin. For port L pins that are configured as outputs, reads return the last value written to this register. Writes are latched into all bits of this register. For port L pins that are configured as outputs, the logic level is driven out the corresponding MCU pin. Reset forces PTLD to all 0s, but these 0s are not driven out the corresponding pins because reset also configures all port pins as high-impedance inputs with pull-ups disabled.</p>

6.5.11.2 Port L Data Direction Register (PTLDD)

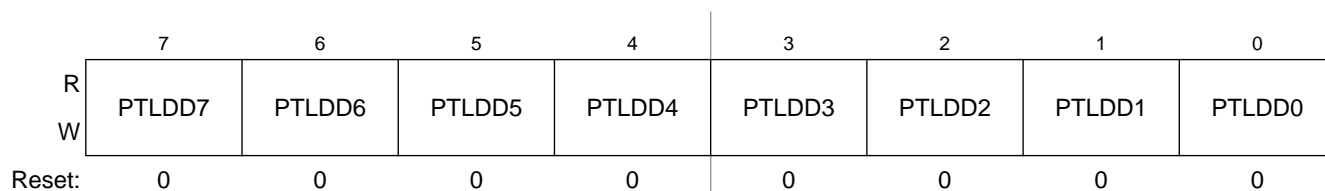

Figure 6-66. Port L Data Direction Register (PTLDD)

Table 6-64. PTLDD Register Field Descriptions

Field	Description
7:0 PTLDD[7:0]	<p>Data Direction for Port L Bits — These read/write bits control the direction of port L pins and what is read for PTLD reads.</p> <p>0 Input (output driver disabled) and reads return the pin value.</p> <p>1 Output driver enabled for port L bit n and PTLD reads return the contents of PTLDDn.</p>

6.5.11.3 Port L Pull Enable Register (PTLPE)

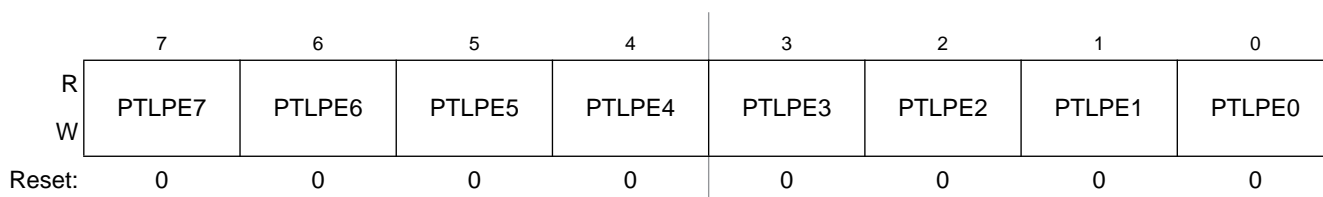

Figure 6-67. Internal Pull Enable for Port L Register (PTLPE)

Table 6-65. PTLPE Register Field Descriptions

Field	Description
7:0 PTLPE[7:0]	<p>Internal Pull Enable for Port L Bits — Each of these control bits determines if the internal pull-up device is enabled for the associated PTL pin. For port L pins that are configured as outputs, these bits have no effect and the internal pull devices are disabled.</p> <p>0 Internal pull-up device disabled for port L bit n. 1 Internal pull-up device enabled for port L bit n.</p>

NOTE

Pull-down devices only apply when using pin interrupt functions, when corresponding edge select and pin select functions are configured.

6.5.11.4 Port L Slew Rate Enable Register (PTLSE)

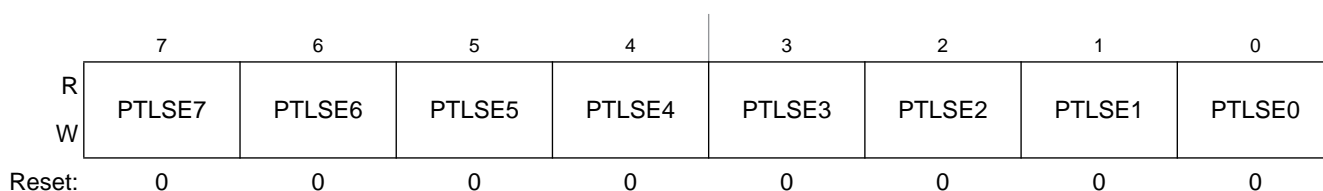

Figure 6-68. Slew Rate Enable for Port L Register (PTLSE)

Table 6-66. PTLSE Register Field Descriptions

Field	Description
7:0 PTLSE[7:0]	<p>Output Slew Rate Enable for Port L Bits — Each of these control bits determines if the output slew rate control is enabled for the associated PTL pin. For port L pins that are configured as inputs, these bits have no effect.</p> <p>0 Output slew rate control disabled for port L bit n. 1 Output slew rate control enabled for port L bit n.</p>

Note: Slew rate reset default values may differ between engineering samples and final production parts. Always initialize slew rate control to the desired value to ensure correct operation.

6.5.11.5 Port L Drive Strength Selection Register (PTLDS)

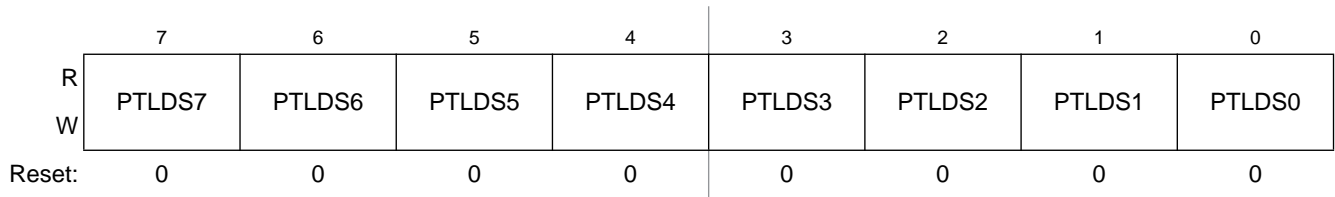

Figure 6-69. Drive Strength Selection for Port L Register (PTLDS)

Table 6-67. PTLDS Register Field Descriptions

Field	Description
7:0 PTLDS[7:0]	<p>Output Drive Strength Selection for Port L Bits — Each of these control bits selects between low and high output drive for the associated PTL pin. For port L pins that are configured as inputs, these bits have no effect.</p> <p>0 Low output drive strength selected for port L bit n.</p> <p>1 High output drive strength selected for port L bit n.</p>

Chapter 7

Central Processor Unit (S08CPUV5)

7.1 Introduction

This section provides summary information about the registers, addressing modes, and instruction set of the CPU of the HCS08 Family. For a more detailed discussion, refer to the *HCS08 Family Reference Manual, volume 1*, Freescale Semiconductor document order number HCS08RMV1/D.

The HCS08 CPU is fully source- and object-code-compatible with the M68HC08 CPU. Several instructions and enhanced addressing modes were added to improve C compiler efficiency and to support a new background debug system which replaces the monitor mode of earlier M68HC08 microcontrollers (MCU).

7.1.1 Features

Features of the HCS08 CPU include:

- Object code fully upward-compatible with M68HC05 and M68HC08 Families
- 64-KB CPU address space with banked memory management unit for greater than 64 KB
- 16-bit stack pointer (any size stack anywhere in 64-KB CPU address space)
- 16-bit index register (H:X) with powerful indexed addressing modes
- 8-bit accumulator (A)
- Many instructions treat X as a second general-purpose 8-bit register
- Seven addressing modes:
 - Inherent — Operands in internal registers
 - Relative — 8-bit signed offset to branch destination
 - Immediate — Operand in next object code byte(s)
 - Direct — Operand in memory at 0x0000–0x00FF
 - Extended — Operand anywhere in 64-Kbyte address space
 - Indexed relative to H:X — Five submodes including auto increment
 - Indexed relative to SP — Improves C efficiency dramatically
- Memory-to-memory data move instructions with four address mode combinations
- Overflow, half-carry, negative, zero, and carry condition codes support conditional branching on the results of signed, unsigned, and binary-coded decimal (BCD) operations
- Efficient bit manipulation instructions
- Fast 8-bit by 8-bit multiply and 16-bit by 8-bit divide instructions
- STOP and WAIT instructions to invoke low-power operating modes

7.2 Programmer's Model and CPU Registers

Figure 7-1 shows the five CPU registers. CPU registers are not part of the memory map.

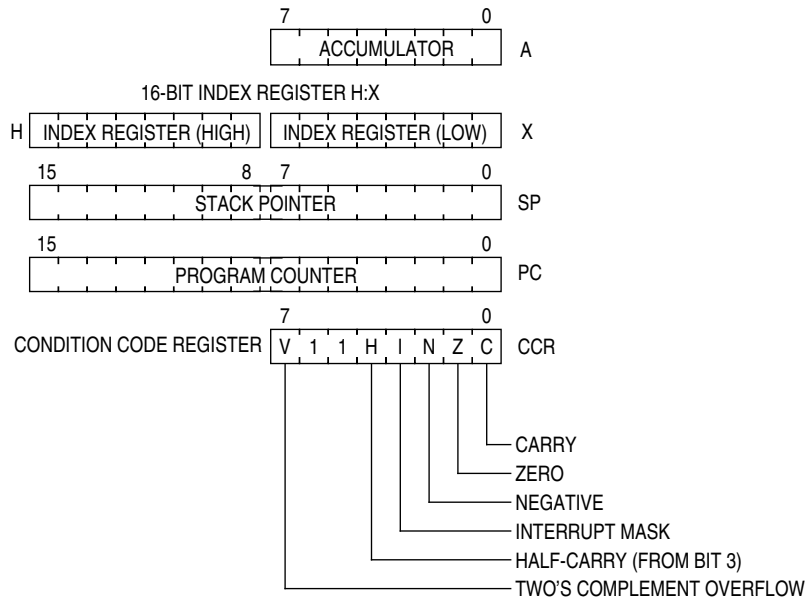

Figure 7-1. CPU Registers

7.2.1 Accumulator (A)

The A accumulator is a general-purpose 8-bit register. One operand input to the arithmetic logic unit (ALU) is connected to the accumulator and the ALU results are often stored into the A accumulator after arithmetic and logical operations. The accumulator can be loaded from memory using various addressing modes to specify the address where the loaded data comes from, or the contents of A can be stored to memory using various addressing modes to specify the address where data from A will be stored.

Reset has no effect on the contents of the A accumulator.

7.2.2 Index Register (H:X)

This 16-bit register is actually two separate 8-bit registers (H and X), which often work together as a 16-bit address pointer where H holds the upper byte of an address and X holds the lower byte of the address. All indexed addressing mode instructions use the full 16-bit value in H:X as an index reference pointer; however, for compatibility with the earlier M68HC05 Family, some instructions operate only on the low-order 8-bit half (X).

Many instructions treat X as a second general-purpose 8-bit register that can be used to hold 8-bit data values. X can be cleared, incremented, decremented, complemented, negated, shifted, or rotated. Transfer instructions allow data to be transferred from A or transferred to A where arithmetic and logical operations can then be performed.

For compatibility with the earlier M68HC05 Family, H is forced to 0x00 during reset. Reset has no effect on the contents of X.

7.2.3 Stack Pointer (SP)

This 16-bit address pointer register points at the next available location on the automatic last-in-first-out (LIFO) stack. The stack may be located anywhere in the 64-Kbyte address space that has RAM and can be any size up to the amount of available RAM. The stack is used to automatically save the return address for subroutine calls, the return address and CPU registers during interrupts, and for local variables. The AIS (add immediate to stack pointer) instruction adds an 8-bit signed immediate value to SP. This is most often used to allocate or deallocate space for local variables on the stack.

SP is forced to 0x00FF at reset for compatibility with the earlier M68HC05 Family. HCS08 programs normally change the value in SP to the address of the last location (highest address) in on-chip RAM during reset initialization to free up direct page RAM (from the end of the on-chip registers to 0x00FF).

The RSP (reset stack pointer) instruction was included for compatibility with the M68HC05 Family and is seldom used in new HCS08 programs because it only affects the low-order half of the stack pointer.

7.2.4 Program Counter (PC)

The program counter is a 16-bit register that contains the address of the next instruction or operand to be fetched.

During normal program execution, the program counter automatically increments to the next sequential memory location every time an instruction or operand is fetched. Jump, branch, interrupt, and return operations load the program counter with an address other than that of the next sequential location. This is called a change-of-flow.

During reset, the program counter is loaded with the reset vector that is located at 0xFFFFE and 0xFFFF. The vector stored there is the address of the first instruction that will be executed after exiting the reset state.

7.2.5 Condition Code Register (CCR)

The 8-bit condition code register contains the interrupt mask (I) and five flags that indicate the results of the instruction just executed. Bits 6 and 5 are set permanently to 1. The following paragraphs describe the functions of the condition code bits in general terms. For a more detailed explanation of how each instruction sets the CCR bits, refer to the *HCS08 Family Reference Manual, volume 1*, Freescale Semiconductor document order number HCS08RMv1.

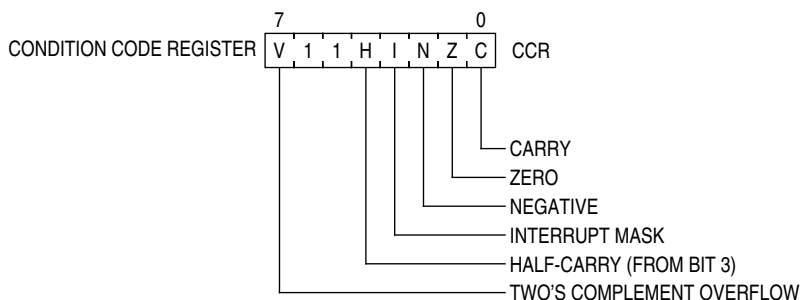

Figure 7-2. Condition Code Register

Table 7-1. CCR Register Field Descriptions

Field	Description
7 V	Two's Complement Overflow Flag — The CPU sets the overflow flag when a two's complement overflow occurs. The signed branch instructions BGT, BGE, BLE, and BLT use the overflow flag. 0 No overflow 1 Overflow
4 H	Half-Carry Flag — The CPU sets the half-carry flag when a carry occurs between accumulator bits 3 and 4 during an add-without-carry (ADD) or add-with-carry (ADC) operation. The half-carry flag is required for binary-coded decimal (BCD) arithmetic operations. The DAA instruction uses the states of the H and C condition code bits to automatically add a correction value to the result from a previous ADD or ADC on BCD operands to correct the result to a valid BCD value. 0 No carry between bits 3 and 4 1 Carry between bits 3 and 4
3 I	Interrupt Mask Bit — When the interrupt mask is set, all maskable CPU interrupts are disabled. CPU interrupts are enabled when the interrupt mask is cleared. When a CPU interrupt occurs, the interrupt mask is set automatically after the CPU registers are saved on the stack, but before the first instruction of the interrupt service routine is executed. Interrupts are not recognized at the instruction boundary after any instruction that clears I (CLI or TAP). This ensures that the next instruction after a CLI or TAP will always be executed without the possibility of an intervening interrupt, provided I was set. 0 Interrupts enabled 1 Interrupts disabled
2 N	Negative Flag — The CPU sets the negative flag when an arithmetic operation, logic operation, or data manipulation produces a negative result, setting bit 7 of the result. Simply loading or storing an 8-bit or 16-bit value causes N to be set if the most significant bit of the loaded or stored value was 1. 0 Non-negative result 1 Negative result
1 Z	Zero Flag — The CPU sets the zero flag when an arithmetic operation, logic operation, or data manipulation produces a result of 0x00 or 0x0000. Simply loading or storing an 8-bit or 16-bit value causes Z to be set if the loaded or stored value was all 0s. 0 Non-zero result 1 Zero result
0 C	Carry/Borrow Flag — The CPU sets the carry/borrow flag when an addition operation produces a carry out of bit 7 of the accumulator or when a subtraction operation requires a borrow. Some instructions — such as bit test and branch, shift, and rotate — also clear or set the carry/borrow flag. 0 No carry out of bit 7 1 Carry out of bit 7

7.3 Addressing Modes

Addressing modes define the way the CPU accesses operands and data. In the HCS08, memory, status and control registers, and input/output (I/O) ports share a single 64-Kbyte CPU address space. This arrangement means that the same instructions that access variables in RAM can also be used to access I/O and control registers or nonvolatile program space.

NOTE

For more information about extended addressing modes, see the Memory Management Unit section in the Memory chapter.

MCU derivatives with more than 64-Kbytes of memory also include a memory management unit (MMU) to support extended memory space. A PPAGE register is used to manage 16-Kbyte pages of memory which can be accessed by the CPU through a 16-Kbyte window from 0x8000 through 0xBFFF. The CPU includes two special instructions (CALL and RTC). CALL operates like the JSR instruction except that CALL saves the current PPAGE value on the stack and provides a new PPAGE value for the destination. RTC works like the RTS instruction except RTC restores the old PPAGE value in addition to the PC during the return from the called routine. The MMU also includes a linear address pointer register and data access registers so that the extended memory space operates as if it was a single linear block of memory. For additional information about the MMU, refer to the Memory chapter of this data sheet.

Some instructions use more than one addressing mode. For instance, move instructions use one addressing mode to specify the source operand and a second addressing mode to specify the destination address. Instructions such as BRCLR, BRSET, CBEQ, and DBNZ use one addressing mode to specify the location of an operand for a test and then use relative addressing mode to specify the branch destination address when the tested condition is true. For BRCLR, BRSET, CBEQ, and DBNZ, the addressing mode listed in the instruction set tables is the addressing mode needed to access the operand to be tested, and relative addressing mode is implied for the branch destination.

7.3.1 Inherent Addressing Mode (INH)

In this addressing mode, operands needed to complete the instruction (if any) are located within CPU registers so the CPU does not need to access memory to get any operands.

7.3.2 Relative Addressing Mode (REL)

Relative addressing mode is used to specify the destination location for branch instructions. A signed 8-bit offset value is located in the memory location immediately following the opcode. During execution, if the branch condition is true, the signed offset is sign-extended to a 16-bit value and is added to the current contents of the program counter, which causes program execution to continue at the branch destination address.

7.3.3 Immediate Addressing Mode (IMM)

In immediate addressing mode, the operand needed to complete the instruction is included in the object code immediately following the instruction opcode in memory. In the case of a 16-bit immediate operand,

the high-order byte is located in the next memory location after the opcode, and the low-order byte is located in the next memory location after that.

7.3.4 Direct Addressing Mode (DIR)

In direct addressing mode, the instruction includes the low-order eight bits of an address in the direct page (0x0000–0x00FF). During execution a 16-bit address is formed by concatenating an implied 0x00 for the high-order half of the address and the direct address from the instruction to get the 16-bit address where the desired operand is located. This is faster and more memory efficient than specifying a complete 16-bit address for the operand.

7.3.5 Extended Addressing Mode (EXT)

In extended addressing mode, the full 16-bit address of the operand is located in the next two bytes of program memory after the opcode (high byte first).

7.3.6 Indexed Addressing Mode

Indexed addressing mode has seven variations including five that use the 16-bit H:X index register pair and two that use the stack pointer as the base reference.

7.3.6.1 Indexed, No Offset (IX)

This variation of indexed addressing uses the 16-bit value in the H:X index register pair as the address of the operand needed to complete the instruction.

7.3.6.2 Indexed, No Offset with Post Increment (IX+)

This variation of indexed addressing uses the 16-bit value in the H:X index register pair as the address of the operand needed to complete the instruction. The index register pair is then incremented ($H:X = H:X + 0x0001$) after the operand has been fetched. This addressing mode is only used for MOV and CBEQ instructions.

7.3.6.3 Indexed, 8-Bit Offset (IX1)

This variation of indexed addressing uses the 16-bit value in the H:X index register pair plus an unsigned 8-bit offset included in the instruction as the address of the operand needed to complete the instruction.

7.3.6.4 Indexed, 8-Bit Offset with Post Increment (IX1+)

This variation of indexed addressing uses the 16-bit value in the H:X index register pair plus an unsigned 8-bit offset included in the instruction as the address of the operand needed to complete the instruction. The index register pair is then incremented ($H:X = H:X + 0x0001$) after the operand has been fetched. This addressing mode is used only for the CBEQ instruction.

7.3.6.5 Indexed, 16-Bit Offset (IX2)

This variation of indexed addressing uses the 16-bit value in the H:X index register pair plus a 16-bit offset included in the instruction as the address of the operand needed to complete the instruction.

7.3.6.6 SP-Relative, 8-Bit Offset (SP1)

This variation of indexed addressing uses the 16-bit value in the stack pointer (SP) plus an unsigned 8-bit offset included in the instruction as the address of the operand needed to complete the instruction.

7.3.6.7 SP-Relative, 16-Bit Offset (SP2)

This variation of indexed addressing uses the 16-bit value in the stack pointer (SP) plus a 16-bit offset included in the instruction as the address of the operand needed to complete the instruction.

7.4 Special Operations

The CPU performs a few special operations that are similar to instructions but do not have opcodes like other CPU instructions. In addition, a few instructions such as STOP and WAIT directly affect other MCU circuitry. This section provides additional information about these operations.

7.4.1 Reset Sequence

Reset can be caused by a power-on-reset (POR) event, internal conditions such as the COP (computer operating properly) watchdog, or by assertion of an external active-low reset pin. When a reset event occurs, the CPU immediately stops whatever it is doing (the MCU does not wait for an instruction boundary before responding to a reset event). For a more detailed discussion about how the MCU recognizes resets and determines the source, refer to the [Resets, Interrupts, and System Configuration](#) chapter.

The reset event is considered concluded when the sequence to determine whether the reset came from an internal source is done and when the reset pin is no longer asserted. At the conclusion of a reset event, the CPU performs a 6-cycle sequence to fetch the reset vector from 0xFFFFE and 0xFFFF and to fill the instruction queue in preparation for execution of the first program instruction.

7.4.2 Interrupt Sequence

When an interrupt is requested, the CPU completes the current instruction before responding to the interrupt. At this point, the program counter is pointing at the start of the next instruction, which is where the CPU should return after servicing the interrupt. The CPU responds to an interrupt by performing the same sequence of operations as for a software interrupt (SWI) instruction, except the address used for the vector fetch is determined by the highest priority interrupt that is pending when the interrupt sequence started.

The CPU sequence for an interrupt is:

1. Store the contents of PCL, PCH, X, A, and CCR on the stack, in that order.
2. Set the I bit in the CCR.

3. Fetch the high-order half of the interrupt vector.
4. Fetch the low-order half of the interrupt vector.
5. Delay for one free bus cycle.
6. Fetch three bytes of program information starting at the address indicated by the interrupt vector to fill the instruction queue in preparation for execution of the first instruction in the interrupt service routine.

After the CCR contents are pushed onto the stack, the I bit in the CCR is set to prevent other interrupts while in the interrupt service routine. Although it is possible to clear the I bit with an instruction in the interrupt service routine, this would allow nesting of interrupts (which is not recommended because it leads to programs that are difficult to debug and maintain).

For compatibility with the earlier M68HC05 MCUs, the high-order half of the H:X index register pair (H) is not saved on the stack as part of the interrupt sequence. The user must use a PSHH instruction at the beginning of the service routine to save H and then use a PULH instruction just before the RTI that ends the interrupt service routine. It is not necessary to save H if you are certain that the interrupt service routine does not use any instructions or auto-increment addressing modes that might change the value of H.

The software interrupt (SWI) instruction is like a hardware interrupt except that it is not masked by the global I bit in the CCR and it is associated with an instruction opcode within the program so it is not asynchronous to program execution.

7.4.3 Wait Mode Operation

The WAIT instruction enables interrupts by clearing the I bit in the CCR. It then halts the clocks to the CPU to reduce overall power consumption while the CPU is waiting for the interrupt or reset event that will wake the CPU from wait mode. When an interrupt or reset event occurs, the CPU clocks will resume and the interrupt or reset event will be processed normally.

If a serial BACKGROUND command is issued to the MCU through the background debug interface while the CPU is in wait mode, CPU clocks will resume and the CPU will enter active background mode where other serial background commands can be processed. This ensures that a host development system can still gain access to a target MCU even if it is in wait mode.

7.4.4 Stop Mode Operation

Usually, all system clocks, including the crystal oscillator (when used), are halted during stop mode to minimize power consumption. In such systems, external circuitry is needed to control the time spent in stop mode and to issue a signal to wake up the target MCU when it is time to resume processing. Unlike the earlier M68HC05 and M68HC08 MCUs, the HCS08 can be configured to keep a minimum set of clocks running in stop mode. This optionally allows an internal periodic signal to wake the target MCU from stop mode.

When a host debug system is connected to the background debug pin (BKGD) and the ENBDM control bit has been set by a serial command through the background interface (or because the MCU was reset into active background mode), the oscillator is forced to remain active when the MCU enters stop mode. In this case, if a serial BACKGROUND command is issued to the MCU through the background debug interface

while the CPU is in stop mode, CPU clocks will resume and the CPU will enter active background mode where other serial background commands can be processed. This ensures that a host development system can still gain access to a target MCU even if it is in stop mode.

Recovery from stop mode depends on the particular HCS08 and whether the oscillator was stopped in stop mode. Refer to the [Modes of Operation](#) chapter for more details.

7.4.5 BGND Instruction

The BGND instruction is new to the HCS08 compared to the M68HC08. BGND would not be used in normal user programs because it forces the CPU to stop processing user instructions and enter the active background mode. The only way to resume execution of the user program is through reset or by a host debug system issuing a GO, TRACE1, or TAGGO serial command through the background debug interface.

Software-based breakpoints can be set by replacing an opcode at the desired breakpoint address with the BGND opcode. When the program reaches this breakpoint address, the CPU is forced to active background mode rather than continuing the user program.

7.5 CALL and RTC Instructions

The CALL is similar to a jump-to-subroutine (JSR) instruction, but the subroutine that is called can be located anywhere in the normal 64-Kbyte address space or on any page of program expansion memory. When CALL is executed, a return address is calculated, then it and the current program page register value are stacked, and a new instruction-supplied value is written to PPAGE. The PPAGE value controls which of the possible 16-Kbyte pages is visible through the window in the 64-Kbyte memory map. Execution continues at the address of the called subroutine.

The actual sequence of operations that occur during execution of CALL is:

1. CPU calculates the address of the next instruction after the CALL instruction (the return address) and pushes this 16-bit value onto the stack, low byte first.
2. CPU reads the old PPAGE value and pushes it onto the stack.
3. CPU writes the new instruction-supplied page select value to PPAGE. This switches the destination page into the program overlay window in the CPU address range 0x8000 0xBFFF.
4. Instruction queue is refilled starting from the destination address, and execution begins at the new address.

This sequence of operations is an uninterruptable CPU instruction. There is no need to inhibit interrupts during CALL execution. In addition, a CALL can be performed from any address in memory to any other address. This is a big improvement over other bank-switching schemes, where the page switch operation can be performed only by a program outside the overlay window.

For all practical purposes, the PPAGE value supplied by the instruction can be considered to be part of the effective address. The new page value is provided by an immediate operand in the instruction.

The RTC instruction is used to terminate subroutines invoked by a CALL instruction. RTC unstacks the PPAGE value and the return address, the queue is refilled, and execution resumes with the next instruction after the corresponding CALL.

The actual sequence of operations that occur during execution of RTC is:

1. The return value of the 8-bit PPAGE register is pulled from the stack.
2. The 16-bit return address is pulled from the stack and loaded into the PC.
3. The return PPAGE value is written to the PPAGE register.
4. The queue is refilled and execution begins at the new address.

Since the return operation is implemented as a single uninterruptable CPU instruction, the RTC can be executed from anywhere in memory, including from a different page of extended memory in the overlay window.

The CALL and RTC instructions behave like JSR and RTS, except they have slightly longer execution times. Since extra execution cycles are required, routinely substituting CALL/RTC for JSR/RTS is not recommended. JSR and RTS can be used to access subroutines that are located outside the program overlay window or on the same memory page. However, if a subroutine can be called from other pages, it must be terminated with an RTC. In this case, since RTC unstacks the PPAGE value as well as the return address, all accesses to the subroutine, even those made from the same page, must use CALL instructions.

7.6 HCS08 Instruction Set Summary

Table 7-2 provides a summary of the HCS08 instruction set in all possible addressing modes. The table shows operand construction, execution time in internal bus clock cycles, and cycle-by-cycle details for each addressing mode variation of each instruction.

Table 7-2. Instruction Set Summary (Sheet 1 of 9)

Source Form	Operation	Address Mode	Object Code	Cycles	Cyc-by-Cyc Details	Affect on CCR	
						V 1 1 H	I N Z C
ADC #opr8i ADC opr8a ADC opr16a ADC oprx16,X ADC oprx8,X ADC ,X ADC oprx16,SP ADC oprx8,SP	Add with Carry $A \leftarrow (A) + (M) + (C)$	IMM DIR EXT IX2 IX1 IX SP2 SP1	A9 ii B9 dd C9 hh ll D9 ee ff E9 ff F9 9E D9 ee ff 9E E9 ff	2 3 4 4 3 3 5 4	pp rpp prpp prpp rpp rff pprpp prpp	$\uparrow 1 1 \uparrow$	$- \uparrow \uparrow \uparrow$
ADD #opr8i ADD opr8a ADD opr16a ADD oprx16,X ADD oprx8,X ADD ,X ADD oprx16,SP ADD oprx8,SP	Add without Carry $A \leftarrow (A) + (M)$	IMM DIR EXT IX2 IX1 IX SP2 SP1	AB ii BB dd CB hh ll DB ee ff EB ff FB 9E DB ee ff 9E EB ff	2 3 4 4 3 3 5 4	pp rpp prpp prpp rpp rff pprpp prpp	$\uparrow 1 1 \uparrow$	$- \uparrow \uparrow \uparrow$
AIS #opr8i	Add Immediate Value (Signed) to Stack Pointer $SP \leftarrow (SP) + (M)$	IMM	A7 ii	2	pp	$- 1 1 -$	$- - - -$
AIX #opr8i	Add Immediate Value (Signed) to Index Register (H:X) $H:X \leftarrow (H:X) + (M)$	IMM	AF ii	2	pp	$- 1 1 -$	$- - - -$
AND #opr8i AND opr8a AND opr16a AND oprx16,X AND oprx8,X AND ,X AND oprx16,SP AND oprx8,SP	Logical AND $A \leftarrow (A) \& (M)$	IMM DIR EXT IX2 IX1 IX SP2 SP1	A4 ii B4 dd C4 hh ll D4 ee ff E4 ff F4 9E D4 ee ff 9E E4 ff	2 3 4 4 3 3 5 4	pp rpp prpp prpp rpp rff pprpp prpp	$0 1 1 -$	$- \uparrow \uparrow -$
ASL opr8a ASLA ASLX ASL oprx8,X ASL ,X ASL oprx8,SP	Arithmetic Shift Left  (Same as LSL)	DIR INH INH IX1 IX SP1	38 dd 48 58 68 ff 78 9E 68 ff	5 1 1 5 4 6	rffwp p p rffwp rffw prffwp	$\uparrow 1 1 -$	$- \uparrow \uparrow \uparrow$
ASR opr8a ASRA ASRX ASR oprx8,X ASR ,X ASR oprx8,SP	Arithmetic Shift Right 	DIR INH INH IX1 IX SP1	37 dd 47 57 67 ff 77 9E 67 ff	5 1 1 5 4 6	rffwp p p rffwp rffw prffwp	$\uparrow 1 1 -$	$- \uparrow \uparrow \uparrow$

Table 7-2. Instruction Set Summary (Sheet 2 of 9)

Source Form	Operation	Address Mode	Object Code	Cycles	Cyc-by-Cyc Details	Affect on CCR	
						V 1 1 H	I N Z C
BCC <i>rel</i>	Branch if Carry Bit Clear (if C = 0)	REL	24 rr	3	ppp	- 1 1 -	- - - -
BCLR <i>n,opr8a</i>	Clear Bit n in Memory (Mn ← 0)	DIR (b0)	11 dd	5	rfwpp	- 1 1 -	- - - -
		DIR (b1)	13 dd	5	rfwpp		
		DIR (b2)	15 dd	5	rfwpp		
		DIR (b3)	17 dd	5	rfwpp		
		DIR (b4)	19 dd	5	rfwpp		
		DIR (b5)	1B dd	5	rfwpp		
		DIR (b6)	1D dd	5	rfwpp		
BCLR <i>n,opr8a</i>	Clear Bit n in Memory (Mn ← 0)	DIR (b7)	1F dd	5	rfwpp		
BCS <i>rel</i>	Branch if Carry Bit Set (if C = 1) (Same as BLO)	REL	25 rr	3	ppp	- 1 1 -	- - - -
BEQ <i>rel</i>	Branch if Equal (if Z = 1)	REL	27 rr	3	ppp	- 1 1 -	- - - -
BGE <i>rel</i>	Branch if Greater Than or Equal To (if N ⊕ V = 0) (Signed)	REL	90 rr	3	ppp	- 1 1 -	- - - -
BGND	Enter active background if ENBDM=1 Waits for and processes BDM commands until GO, TRACE1, or TAGGO	INH	82	5+	fp...ppp	- 1 1 -	- - - -
BGT <i>rel</i>	Branch if Greater Than (if Z (N ⊕ V) = 0) (Signed)	REL	92 rr	3	ppp	- 1 1 -	- - - -
BHCC <i>rel</i>	Branch if Half Carry Bit Clear (if H = 0)	REL	28 rr	3	ppp	- 1 1 -	- - - -
BHCS <i>rel</i>	Branch if Half Carry Bit Set (if H = 1)	REL	29 rr	3	ppp	- 1 1 -	- - - -
BHI <i>rel</i>	Branch if Higher (if C Z = 0)	REL	22 rr	3	ppp	- 1 1 -	- - - -
BHS <i>rel</i>	Branch if Higher or Same (if C = 0) (Same as BCC)	REL	24 rr	3	ppp	- 1 1 -	- - - -
BIH <i>rel</i>	Branch if IRQ Pin High (if IRQ pin = 1)	REL	2F rr	3	ppp	- 1 1 -	- - - -
BIL <i>rel</i>	Branch if IRQ Pin Low (if IRQ pin = 0)	REL	2E rr	3	ppp	- 1 1 -	- - - -
BIT # <i>opr8i</i> BIT <i>opr8a</i> BIT <i>opr16a</i> BIT <i>opr16,X</i> BIT <i>opr8,X</i> BIT <i>,X</i> BIT <i>opr16,SP</i> BIT <i>opr8,SP</i>	Bit Test (A) & (M) (CCR Updated but Operands Not Changed)	IMM DIR EXT IX2 IX1 IX SP2 SP1	A5 ii B5 dd C5 hh ll D5 ee ff E5 ff F5 9E D5 ee ff 9E E5 ff	2 3 4 4 3 3 5 4	pp rpp prpp prpp rpp rfp pprpp prpp	0 1 1 -	- ↑ ↓ -
BLE <i>rel</i>	Branch if Less Than or Equal To (if Z (N ⊕ V) = 1) (Signed)	REL	93 rr	3	ppp	- 1 1 -	- - - -
BLO <i>rel</i>	Branch if Lower (if C = 1) (Same as BCS)	REL	25 rr	3	ppp	- 1 1 -	- - - -
BLS <i>rel</i>	Branch if Lower or Same (if C Z = 1)	REL	23 rr	3	ppp	- 1 1 -	- - - -
BLT <i>rel</i>	Branch if Less Than (if N ⊕ V = 1) (Signed)	REL	91 rr	3	ppp	- 1 1 -	- - - -
BMC <i>rel</i>	Branch if Interrupt Mask Clear (if I = 0)	REL	2C rr	3	ppp	- 1 1 -	- - - -
BMI <i>rel</i>	Branch if Minus (if N = 1)	REL	2B rr	3	ppp	- 1 1 -	- - - -
BMS <i>rel</i>	Branch if Interrupt Mask Set (if I = 1)	REL	2D rr	3	ppp	- 1 1 -	- - - -
BNE <i>rel</i>	Branch if Not Equal (if Z = 0)	REL	26 rr	3	ppp	- 1 1 -	- - - -

Table 7-2. Instruction Set Summary (Sheet 3 of 9)

Source Form	Operation	Address Mode	Object Code	Cycles	Cyc-by-Cyc Details	Affect on CCR	
						V 1 1 H	I N Z C
BPL <i>rel</i>	Branch if Plus (if N = 0)	REL	2A rr	3	ppp	- 1 1 -	- - - -
BRA <i>rel</i>	Branch Always (if I = 1)	REL	20 rr	3	ppp	- 1 1 -	- - - -
BRCLR <i>n,opr8a,rel</i>	Branch if Bit <i>n</i> in Memory Clear (if (Mn) = 0)	DIR (b0) DIR (b1) DIR (b2) DIR (b3) DIR (b4) DIR (b5) DIR (b6) DIR (b7)	01 dd rr 03 dd rr 05 dd rr 07 dd rr 09 dd rr 0B dd rr 0D dd rr 0F dd rr	5 5 5 5 5 5 5 5	rpppp rpppp rpppp rpppp rpppp rpppp rpppp rpppp	- 1 1 -	- - - - ↑
BRN <i>rel</i>	Branch Never (if I = 0)	REL	21 rr	3	ppp	- 1 1 -	- - - -
BRSET <i>n,opr8a,rel</i>	Branch if Bit <i>n</i> in Memory Set (if (Mn) = 1)	DIR (b0) DIR (b1) DIR (b2) DIR (b3) DIR (b4) DIR (b5) DIR (b6) DIR (b7)	00 dd rr 02 dd rr 04 dd rr 06 dd rr 08 dd rr 0A dd rr 0C dd rr 0E dd rr	5 5 5 5 5 5 5 5	rpppp rpppp rpppp rpppp rpppp rpppp rpppp rpppp	- 1 1 -	- - - - ↑
BSET <i>n,opr8a</i>	Set Bit <i>n</i> in Memory (Mn ← 1)	DIR (b0) DIR (b1) DIR (b2) DIR (b3) DIR (b4) DIR (b5) DIR (b6) DIR (b7)	10 dd 12 dd 14 dd 16 dd 18 dd 1A dd 1C dd 1E dd	5 5 5 5 5 5 5 5	rfwpp rfwpp rfwpp rfwpp rfwpp rfwpp rfwpp rfwpp	- 1 1 -	- - - -
BSR <i>rel</i>	Branch to Subroutine PC ← (PC) + \$0002 push (PCL); SP ← (SP) - \$0001 push (PCH); SP ← (SP) - \$0001 PC ← (PC) + <i>rel</i>	REL	AD rr	5	ssppp	- 1 1 -	- - - -
CALL <i>page, opr16a</i>	Call Subroutine	EXT	AC pg hhll	8	ppsssppp	- 1 1 -	- - - -
CBEQ <i>opr8a,rel</i> CBEQA # <i>opr8i,rel</i> CBEQX # <i>opr8i,rel</i> CBEQ <i>opr8,X+,rel</i> CBEQ <i>,X+,rel</i> CBEQ <i>opr8,SP,rel</i>	Compare and... Branch if (A) = (M) Branch if (A) = (M) Branch if (X) = (M) Branch if (A) = (M) Branch if (A) = (M) Branch if (A) = (M)	DIR IMM IMM IX1+ IX+ SP1	31 dd rr 41 ii rr 51 ii rr 61 ff rr 71 rr 9E 61 ff rr	5 4 4 5 5 6	rpppp pppp pppp rpppp rfppp prpppp	- 1 1 -	- - - -
CLC	Clear Carry Bit (C ← 0)	INH	98	1	p	- 1 1 -	- - - 0
CLI	Clear Interrupt Mask Bit (I ← 0)	INH	9A	1	p	- 1 1 -	0 - - -
CLR <i>opr8a</i> CLRA CLR X CLR H CLR <i>opr8,X</i> CLR <i>,X</i> CLR <i>opr8,SP</i>	Clear M ← \$00 A ← \$00 X ← \$00 H ← \$00 M ← \$00 M ← \$00 M ← \$00	DIR INH INH INH IX1 IX SP1	3F dd 4F 5F 8C 6F ff 7F 9E 6F ff	5 1 1 1 5 4 6	rfwpp p p p rfwpp rfwp prfwpp	0 1 1 -	- 0 1 -

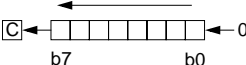
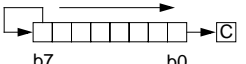
Table 7-2. Instruction Set Summary (Sheet 4 of 9)

Source Form	Operation	Address Mode	Object Code	Cycles	Cyc-by-Cyc Details	Affect on CCR	
						V I 1 H	I N Z C
CMP #opr8i CMP opr8a CMP opr16a CMP oprx16,X CMP oprx8,X CMP ,X CMP oprx16,SP CMP oprx8,SP	Compare Accumulator with Memory A – M (CCR Updated But Operands Not Changed)	IMM DIR EXT IX2 IX1 IX SP2 SP1	A1 ii B1 dd C1 hh ll D1 ee ff E1 ff F1 9E D1 ee ff 9E E1 ff	2 3 4 4 3 3 5 4	pp rpp prpp prpp rpp rfp pprpp prpp	↓ 1 1 –	– ↓ ↓ ↓
COM opr8a COMA COMX COM oprx8,X COM ,X COM oprx8,SP	Complement M ← (M̄) = \$FF – (M) (One's Complement) A ← (Ā) = \$FF – (A) X ← (X̄) = \$FF – (X) M ← (M̄) = \$FF – (M) M ← (M̄) = \$FF – (M) M ← (M̄) = \$FF – (M)	DIR INH INH IX1 IX SP1	33 dd 43 53 63 ff 73 9E 63 ff	5 1 1 5 4 6	rfwpp p p rfwpp rfwp prfwpp	0 1 1 –	– ↓ ↓ ↓ 1
CPHX opr16a CPHX #opr16i CPHX opr8a CPHX oprx8,SP	Compare Index Register (H:X) with Memory (H:X) – (M:M + \$0001) (CCR Updated But Operands Not Changed)	EXT IMM DIR SP1	3E hh ll 65 jj kk 75 dd 9E F3 ff	6 3 5 6	prrfpp ppp rrfpp prrfpp	↓ 1 1 –	– ↓ ↓ ↓
CPX #opr8i CPX opr8a CPX opr16a CPX oprx16,X CPX oprx8,X CPX ,X CPX oprx16,SP CPX oprx8,SP	Compare X (Index Register Low) with Memory X – M (CCR Updated But Operands Not Changed)	IMM DIR EXT IX2 IX1 IX SP2 SP1	A3 ii B3 dd C3 hh ll D3 ee ff E3 ff F3 9E D3 ee ff 9E E3 ff	2 3 4 4 3 3 5 4	pp rpp prpp prpp rpp rfp pprpp prpp	↓ 1 1 –	– ↓ ↓ ↓
DAA	Decimal Adjust Accumulator After ADD or ADC of BCD Values	INH	72	1	p	U 1 1 –	– ↓ ↓ ↓
DBNZ opr8a,rel DBNZ rel DBNZX rel DBNZ oprx8,X,rel DBNZ ,X,rel DBNZ oprx8,SP,rel	Decrement A, X, or M and Branch if Not Zero (if (result) ≠ 0) DBNZX Affects X Not H	DIR INH INH IX1 IX SP1	3B dd rr 4B rr 5B rr 6B ff rr 7B rr 9E 6B ff rr	7 4 4 7 6 8	rfwpppp fppp fppp rfwpppp rfwppp prfwpppp	– 1 1 –	– – – –
DEC opr8a DECA DECX DEC oprx8,X DEC ,X DEC oprx8,SP	Decrement M ← (M) – \$01 A ← (A) – \$01 X ← (X) – \$01 M ← (M) – \$01 M ← (M) – \$01 M ← (M) – \$01	DIR INH INH IX1 IX SP1	3A dd 4A 5A 6A ff 7A 9E 6A ff	5 1 1 5 4 6	rfwpp p p rfwpp rfwp prfwpp	↓ 1 1 –	– ↓ ↓ –
DIV	Divide A ← (H:A)÷(X); H ← Remainder	INH	52	6	ffffffp	– 1 1 –	– – ↓ ↓
EOR #opr8i EOR opr8a EOR opr16a EOR oprx16,X EOR oprx8,X EOR ,X EOR oprx16,SP EOR oprx8,SP	Exclusive OR Memory with Accumulator A ← (A ⊕ M)	IMM DIR EXT IX2 IX1 IX SP2 SP1	A8 ii B8 dd C8 hh ll D8 ee ff E8 ff F8 9E D8 ee ff 9E E8 ff	2 3 4 4 3 3 5 4	pp rpp prpp prpp rpp rfp pprpp prpp	0 1 1 –	– ↓ ↓ –

Table 7-2. Instruction Set Summary (Sheet 5 of 9)

Source Form	Operation	Address Mode	Object Code	Cycles	Cyc-by-Cyc Details	Affect on CCR	
						V I 1 H	I N Z C
INC <i>opr8a</i> INCA INCX INC <i>opr8,X</i> INC <i>,X</i> INC <i>opr8,SP</i>	Increment $M \leftarrow (M) + \$01$ $A \leftarrow (A) + \$01$ $X \leftarrow (X) + \$01$ $M \leftarrow (M) + \$01$ $M \leftarrow (M) + \$01$ $M \leftarrow (M) + \$01$	DIR INH INH IX1 IX SP1	3C dd 4C 5C 6C ff 7C 9E 6C ff	5 1 1 5 4 6	rfwpp p p rfwpp rfwp prfwpp	$\uparrow 1 1 -$	$- \uparrow \downarrow -$
JMP <i>opr8a</i> JMP <i>opr16a</i> JMP <i>opr16,X</i> JMP <i>opr8,X</i> JMP <i>,X</i>	Jump PC \leftarrow Jump Address	DIR EXT IX2 IX1 IX	BC dd CC hh ll DC ee ff EC ff FC	3 4 4 3 3	ppp pppp pppp ppp ppp	$- 1 1 -$	$- - - - -$
JSR <i>opr8a</i> JSR <i>opr16a</i> JSR <i>opr16,X</i> JSR <i>opr8,X</i> JSR <i>,X</i>	Jump to Subroutine PC \leftarrow (PC) + <i>n</i> (<i>n</i> = 1, 2, or 3) Push (PCL); SP \leftarrow (SP) - \$0001 Push (PCH); SP \leftarrow (SP) - \$0001 PC \leftarrow Unconditional Address	DIR EXT IX2 IX1 IX	BD dd CD hh ll DD ee ff ED ff FD	5 6 6 5 5	ssppp pssppp pssppp ssppp ssppp	$- 1 1 -$	$- - - - -$
LDA # <i>opr8i</i> LDA <i>opr8a</i> LDA <i>opr16a</i> LDA <i>opr16,X</i> LDA <i>opr8,X</i> LDA <i>,X</i> LDA <i>opr16,SP</i> LDA <i>opr8,SP</i>	Load Accumulator from Memory $A \leftarrow (M)$	IMM DIR EXT IX2 IX1 IX SP2 SP1	A6 ii B6 dd C6 hh ll D6 ee ff E6 ff F6 9E D6 ee ff 9E E6 ff	2 3 4 4 3 3 5 4	pp rpp prpp prpp rpp rfp pprpp prpp	0 1 1 -	$- \uparrow \downarrow -$
LDHX # <i>opr16i</i> LDHX <i>opr8a</i> LDHX <i>opr16a</i> LDHX <i>,X</i> LDHX <i>opr16,X</i> LDHX <i>opr8,X</i> LDHX <i>opr8,SP</i>	Load Index Register (H:X) $H:X \leftarrow (M:M + \$0001)$	IMM DIR EXT IX IX2 IX1 SP1	45 jj kk 55 dd 32 hh ll 9E AE 9E BE ee ff 9E CE ff 9E FE ff	3 4 5 5 6 5 5	ppp rrpp prpp prpp pprpp prpp prpp	0 1 1 -	$- \uparrow \downarrow -$
LDX # <i>opr8i</i> LDX <i>opr8a</i> LDX <i>opr16a</i> LDX <i>opr16,X</i> LDX <i>opr8,X</i> LDX <i>,X</i> LDX <i>opr16,SP</i> LDX <i>opr8,SP</i>	Load X (Index Register Low) from Memory $X \leftarrow (M)$	IMM DIR EXT IX2 IX1 IX SP2 SP1	AE ii BE dd CE hh ll DE ee ff EE ff FE 9E DE ee ff 9E EE ff	2 3 4 4 3 3 5 4	pp rpp prpp prpp rpp rfp pprpp prpp	0 1 1 -	$- \uparrow \downarrow -$
LSL <i>opr8a</i> LSLA LSLX LSL <i>opr8,X</i> LSL <i>,X</i> LSL <i>opr8,SP</i>	Logical Shift Left  (Same as ASL)	DIR INH INH IX1 IX SP1	38 dd 48 58 68 ff 78 9E 68 ff	5 1 1 5 4 6	rfwpp p p rfwpp rfwp prfwpp	$\uparrow 1 1 -$	$- \uparrow \downarrow \uparrow$
LSR <i>opr8a</i> LSRA LSRX LSR <i>opr8,X</i> LSR <i>,X</i> LSR <i>opr8,SP</i>	Logical Shift Right 	DIR INH INH IX1 IX SP1	34 dd 44 54 64 ff 74 9E 64 ff	5 1 1 5 4 6	rfwpp p p rfwpp rfwp prfwpp	$\uparrow 1 1 -$	$- 0 \uparrow \downarrow$

Table 7-2. Instruction Set Summary (Sheet 6 of 9)

Source Form	Operation	Address Mode	Object Code	Cycles	Cyc-by-Cyc Details	Affect on CCR	
						V I 1 H	I N Z C
MOV <i>opr8a,opr8a</i> MOV <i>opr8a,X+</i> MOV <i>#opr8i,opr8a</i> MOV <i>,X+,opr8a</i>	Move $(M)_{\text{destination}} \leftarrow (M)_{\text{source}}$ In IX+/DIR and DIR/IX+ Modes, $H:X \leftarrow (H:X) + \$0001$	DIR/DIR DIR/IX+ IMM/DIR IX+/DIR	4E dd dd 5E dd 6E ii dd 7E dd	5 5 4 5	rfwpp rfwpp pwpp rfwpp	0 1 1 -	- \uparrow \downarrow \uparrow -
MUL	Unsigned multiply $X:A \leftarrow (X) \times (A)$	INH	42	5	ffffp	- 1 1 0	- - - - 0
NEG <i>opr8a</i> NEGA NEGX NEG <i>opr8,X</i> NEG <i>,X</i> NEG <i>opr8,SP</i>	Negate $M \leftarrow -(M) = \$00 - (M)$ (Two's Complement) $A \leftarrow -(A) = \$00 - (A)$ $X \leftarrow -(X) = \$00 - (X)$ $M \leftarrow -(M) = \$00 - (M)$ $M \leftarrow -(M) = \$00 - (M)$ $M \leftarrow -(M) = \$00 - (M)$	DIR INH INH IX1 IX SP1	30 dd 40 50 60 ff 70 9E 60 ff	5 1 1 5 4 6	rfwpp p p rfwpp rfwp prfwpp	\uparrow 1 1 -	- \uparrow \downarrow \uparrow \downarrow
NOP	No Operation — Uses 1 Bus Cycle	INH	9D	1	p	- 1 1 -	- - - - -
NSA	Nibble Swap Accumulator $A \leftarrow (A[3:0]:A[7:4])$	INH	62	1	p	- 1 1 -	- - - - -
ORA <i>#opr8i</i> ORA <i>opr8a</i> ORA <i>opr16a</i> ORA <i>opr8,X</i> ORA <i>opr8,X</i> ORA <i>,X</i> ORA <i>opr8,SP</i> ORA <i>opr8,SP</i>	Inclusive OR Accumulator and Memory $A \leftarrow (A) (M)$	IMM DIR EXT IX2 IX1 IX SP2 SP1	AA ii BA dd CA hh ll DA ee ff EA ff FA 9E DA ee ff 9E EA ff	2 3 4 4 3 3 5 4	pp rpp prpp prpp rpp rfp pprpp prpp	0 1 1 -	- \uparrow \downarrow \uparrow -
PSHA	Push Accumulator onto Stack Push (A); $SP \leftarrow (SP) - \$0001$	INH	87	2	sp	- 1 1 -	- - - - -
PSHH	Push H (Index Register High) onto Stack Push (H); $SP \leftarrow (SP) - \$0001$	INH	8B	2	sp	- 1 1 -	- - - - -
PSHX	Push X (Index Register Low) onto Stack Push (X); $SP \leftarrow (SP) - \$0001$	INH	89	2	sp	- 1 1 -	- - - - -
PULA	Pull Accumulator from Stack $SP \leftarrow (SP + \$0001)$; Pull (A)	INH	86	3	ufp	- 1 1 -	- - - - -
PULH	Pull H (Index Register High) from Stack $SP \leftarrow (SP + \$0001)$; Pull (H)	INH	8A	3	ufp	- 1 1 -	- - - - -
PULX	Pull X (Index Register Low) from Stack $SP \leftarrow (SP + \$0001)$; Pull (X)	INH	88	3	ufp	- 1 1 -	- - - - -
ROL <i>opr8a</i> ROLA ROLX ROL <i>opr8,X</i> ROL <i>,X</i> ROL <i>opr8,SP</i>	Rotate Left through Carry 	DIR INH INH IX1 IX SP1	39 dd 49 59 69 ff 79 9E 69 ff	5 1 1 5 4 6	rfwpp p p rfwpp rfwp prfwpp	\uparrow 1 1 -	- \uparrow \downarrow \uparrow \downarrow
ROR <i>opr8a</i> RORA RORX ROR <i>opr8,X</i> ROR <i>,X</i> ROR <i>opr8,SP</i>	Rotate Right through Carry 	DIR INH INH IX1 IX SP1	36 dd 46 56 66 ff 76 9E 66 ff	5 1 1 5 4 6	rfwpp p p rfwpp rfwp prfwpp	\uparrow 1 1 -	- \uparrow \downarrow \uparrow \downarrow

Table 7-2. Instruction Set Summary (Sheet 7 of 9)

Source Form	Operation	Address Mode	Object Code	Cycles	Cyc-by-Cyc Details	Affect on CCR	
						V 1 1 H	I N Z C
RSP	Reset Stack Pointer (Low Byte) SPL ← \$FF (High Byte Not Affected)	INH	9C	1	p	- 1 1 -	- - - -
RTC	Return from CALL	INH	8D	7	uuufppp	- 1 1 -	- - - -
RTI	Return from Interrupt SP ← (SP) + \$0001; Pull (CCR) SP ← (SP) + \$0001; Pull (A) SP ← (SP) + \$0001; Pull (X) SP ← (SP) + \$0001; Pull (PCH) SP ← (SP) + \$0001; Pull (PCL)	INH	80	9	uuuuufppp	↑ 1 1 ↓	↑ ↓ ↑ ↓
RTS	Return from Subroutine SP ← SP + \$0001; Pull (PCH) SP ← SP + \$0001; Pull (PCL)	INH	81	5	ufppp	- 1 1 -	- - - -
SBC #opr8i SBC opr8a SBC opr16a SBC oprx16,X SBC oprx8,X SBC ,X SBC oprx16,SP SBC oprx8,SP	Subtract with Carry A ← (A) - (M) - (C)	IMM DIR EXT IX2 IX1 IX SP2 SP1	A2 ii B2 dd C2 hh ll D2 ee ff E2 ff F2 9E D2 ee ff 9E E2 ff	2 3 4 4 3 3 5 4	pp rpp prpp prpp rpp rfp pprpp prpp	↑ 1 1 -	- ↑ ↓ ↓
SEC	Set Carry Bit (C ← 1)	INH	99	1	p	- 1 1 -	- - - 1
SEI	Set Interrupt Mask Bit (I ← 1)	INH	9B	1	p	- 1 1 -	1 - - -
STA opr8a STA opr16a STA oprx16,X STA oprx8,X STA ,X STA oprx16,SP STA oprx8,SP	Store Accumulator in Memory M ← (A)	DIR EXT IX2 IX1 IX SP2 SP1	B7 dd C7 hh ll D7 ee ff E7 ff F7 9E D7 ee ff 9E E7 ff	3 4 4 3 2 5 4	wpp pwpp pwpp wpp wp ppwpp pwpp	0 1 1 -	- ↑ ↓ ↓ -
STHX opr8a STHX opr16a STHX oprx8,SP	Store H:X (Index Reg.) (M:M + \$0001) ← (H:X)	DIR EXT SP1	35 dd 96 hh ll 9E FF ff	4 5 5	wwpp pwwpp pwwpp	0 1 1 -	- ↑ ↓ ↓ -
STOP	Enable Interrupts: Stop Processing Refer to MCU Documentation I bit ← 0; Stop Processing	INH	8E	2	fp...	- 1 1 -	0 - - -
STX opr8a STX opr16a STX oprx16,X STX oprx8,X STX ,X STX oprx16,SP STX oprx8,SP	Store X (Low 8 Bits of Index Register) in Memory M ← (X)	DIR EXT IX2 IX1 IX SP2 SP1	BF dd CF hh ll DF ee ff EF ff FF 9E DF ee ff 9E EF ff	3 4 4 3 2 5 4	wpp pwpp pwpp wpp wp ppwpp pwpp	0 1 1 -	- ↑ ↓ ↓ -

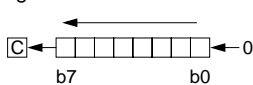
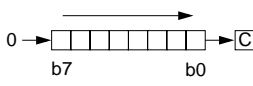
Table 7-2. Instruction Set Summary (Sheet 8 of 9)

Source Form	Operation	Address Mode	Object Code	Cycles	Cyc-by-Cyc Details	Affect on CCR	
						V I 1 H	I N Z C
SUB #opr8i SUB opr8a SUB opr16a SUB oprx16,X SUB oprx8,X SUB ,X SUB oprx16,SP SUB oprx8,SP	Subtract $A \leftarrow (A) - (M)$	IMM DIR EXT IX2 IX1 IX SP2 SP1	A0 ii B0 dd C0 hh ll D0 ee ff E0 ff F0 9E D0 ee ff 9E E0 ff	2 3 4 4 3 3 5 4	pp rpp prpp prpp rpp rfp pprpp prpp	\uparrow 1 1 -	- \uparrow \uparrow \uparrow
SWI	Software Interrupt $PC \leftarrow (PC) + \$0001$ Push (PCL); $SP \leftarrow (SP) - \$0001$ Push (PCH); $SP \leftarrow (SP) - \$0001$ Push (X); $SP \leftarrow (SP) - \$0001$ Push (A); $SP \leftarrow (SP) - \$0001$ Push (CCR); $SP \leftarrow (SP) - \$0001$ $I \leftarrow 1$; PCH \leftarrow Interrupt Vector High Byte PCL \leftarrow Interrupt Vector Low Byte	INH	83	11	sssssvvfppp	- 1 1 -	1 - - -
TAP	Transfer Accumulator to CCR $CCR \leftarrow (A)$	INH	84	1	p	\uparrow 1 1 \uparrow	\uparrow \uparrow \uparrow \uparrow
TAX	Transfer Accumulator to X (Index Register Low) $X \leftarrow (A)$	INH	97	1	p	- 1 1 -	- - - -
TPA	Transfer CCR to Accumulator $A \leftarrow (CCR)$	INH	85	1	p	- 1 1 -	- - - -
TST opr8a TSTA TSTX TST oprx8,X TST ,X TST oprx8,SP	Test for Negative or Zero (M) - \$00 (A) - \$00 (X) - \$00 (M) - \$00 (M) - \$00 (M) - \$00	DIR INH INH IX1 IX SP1	3D dd 4D 5D 6D ff 7D 9E 6D ff	4 1 1 4 3 5	rfpp p p rfpp rfp prfpp	0 1 1 -	- \uparrow \uparrow -
TSX	Transfer SP to Index Reg. $H:X \leftarrow (SP) + \$0001$	INH	95	2	fp	- 1 1 -	- - - -
TXA	Transfer X (Index Reg. Low) to Accumulator $A \leftarrow (X)$	INH	9F	1	p	- 1 1 -	- - - -

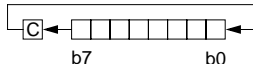
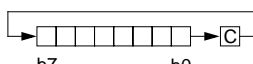
Table 7-2. Instruction Set Summary (Sheet 9 of 9)

Source Form	Operation	Address Mode	Object Code	Cycles	Cyc-by-Cyc Details	Affect on CCR	
						V I I H	I N Z C
TXS	Transfer Index Reg. to SP SP ← (H:X) – \$0001	INH	94	2	f _p	- 1 1 -	- - - -
WAIT	Enable Interrupts; Wait for Interrupt I bit ← 0; Halt CPU	INH	8F	2+	f _p . . .	- 1 1 -	0 - - -

Source Form: Everything in the source forms columns, *except expressions in italic characters*, is literal information which must appear in the assembly source file exactly as shown. The initial 3- to 5-letter mnemonic and the characters (#, (,) and +) are always a literal characters.

- n* Any label or expression that evaluates to a single integer in the range 0-7.
- opr8i* Any label or expression that evaluates to an 8-bit immediate value.
- opr16i* Any label or expression that evaluates to a 16-bit immediate value.
- opr8a* Any label or expression that evaluates to an 8-bit direct-page address (\$00xx).
- opr16a* Any label or expression that evaluates to a 16-bit address.
- opr8* Any label or expression that evaluates to an unsigned 8-bit value, used for indexed addressing.
- opr16* Any label or expression that evaluates to a 16-bit value, used for indexed addressing.
- rel* Any label or expression that refers to an address that is within –128 to +127 locations from the start of the next instruction.

Operation Symbols:

- A Accumulator
- CCR Condition code register
- H Index register high byte
- M Memory location
- n* Any bit
- opr* Operand (one or two bytes)
- PC Program counter
- PCH Program counter high byte
- PCL Program counter low byte
- rel* Relative program counter offset byte
- SP Stack pointer
- SPL Stack pointer low byte
- X Index register low byte
- & Logical AND
- | Logical OR
- ⊕ Logical EXCLUSIVE OR
- () Contents of
- + Add
- Subtract, Negation (two's complement)
- × Multiply
- ÷ Divide
- # Immediate value
- ← Loaded with
- :

CCR Bits:

- V Overflow bit
- H Half-carry bit
- I Interrupt mask
- N Negative bit
- Z Zero bit
- C Carry/borrow bit

Addressing Modes:

- DIR Direct addressing mode
- EXT Extended addressing mode
- IMM Immediate addressing mode
- INH Inherent addressing mode
- IX Indexed, no offset addressing mode
- IX1 Indexed, 8-bit offset addressing mode
- IX2 Indexed, 16-bit offset addressing mode
- IX+ Indexed, no offset, post increment addressing mode
- IX1+ Indexed, 8-bit offset, post increment addressing mode
- REL Relative addressing mode
- SP1 Stack pointer, 8-bit offset addressing mode
- SP2 Stack pointer 16-bit offset addressing mode

Cycle-by-Cycle Codes:

- f Free cycle. This indicates a cycle where the CPU does not require use of the system buses. An f cycle is always one cycle of the system bus clock and is always a read cycle.
- p Program fetch; read from next consecutive location in program memory
- r Read 8-bit operand
- s Push (write) one byte onto stack
- u Pop (read) one byte from stack
- v Read vector from \$FFxx (high byte first)
- w Write 8-bit operand

CCR Effects:

- ↑ Set or cleared
- Not affected
- U Undefined

Table 7-3. Opcode Map (Sheet 1 of 2)

Bit-Manipulation		Branch		Read-Modify-Write				Control				Register/Memory							
00 5 BRSET0 3 DIR	10 5 BSET0 2 DIR	20 3 BRA 2 REL	30 5 NEG 2 DIR	40 1 NEGA 1 INH	50 1 NEGX 1 INH	60 5 NEG 2 IX1	70 4 NEG 1 IX	80 9 RTI 1 INH	90 3 BGE 2 REL	A0 2 SUB 2 IMM	B0 3 SUB 2 DIR	C0 4 SUB 3 EXT	D0 4 SUB 3 IX2	E0 3 SUB 2 IX1	F0 3 SUB 1 IX				
01 5 BRCLR0 3 DIR	11 5 BCLR0 2 DIR	21 3 BRN 2 REL	31 5 CBEQ 3 DIR	41 1 CBEQA 3 IMM	51 4 CBEQX 3 IMM	61 5 CBEQ 3 IX1+	71 5 CBEQ 2 IX+	81 6 RTS 1 INH	91 3 BLT 2 REL	A1 2 CMP 2 IMM	B1 3 CMP 2 DIR	C1 4 CMP 3 EXT	D1 4 CMP 3 IX2	E1 3 CMP 2 IX1	F1 3 CMP 1 IX				
02 5 BRSET1 3 DIR	12 5 BSET1 2 DIR	22 3 BHI 2 REL	32 5 LDHX 3 EXT	42 5 MUL 1 INH	52 6 DIV 1 INH	62 1 NSA 1 INH	72 4 DAA 1 INH	82 5+ BGND 1 INH	92 3 BGT 2 REL	A2 2 SBC 2 IMM	B2 3 SBC 2 DIR	C2 4 SBC 3 EXT	D2 4 SBC 3 IX2	E2 3 SBC 2 IX1	F2 3 SBC 1 IX				
03 5 BRCLR1 3 DIR	13 5 BCLR1 2 DIR	23 3 BLS 2 REL	33 5 COM 2 DIR	43 1 COMA 1 INH	53 1 COMX 1 INH	63 5 COM 2 IX1	73 4 COM 1 IX	83 11 SWI 1 INH	93 3 BLE 2 REL	A3 2 CPX 2 IMM	B3 3 CPX 2 DIR	C3 4 CPX 3 EXT	D3 4 CPX 3 IX2	E3 3 CPX 2 IX1	F3 3 CPX 1 IX				
04 5 BRSET2 3 DIR	14 5 BSET2 2 DIR	24 3 BCC 2 REL	34 5 LSR 2 DIR	44 1 LSRA 1 INH	54 1 LSRX 1 INH	64 5 LSR 2 IX1	74 4 LSR 1 IX	84 1 TAP 1 INH	94 2 TXS 1 INH	A4 2 AND 2 IMM	B4 3 AND 2 DIR	C4 4 AND 3 EXT	D4 4 AND 3 IX2	E4 3 AND 2 IX1	F4 3 AND 1 IX				
05 5 BRCLR2 3 DIR	15 5 BCLR2 2 DIR	25 3 BCS 2 REL	35 4 STHX 2 DIR	45 3 LDHX 3 IMM	55 4 LDHX 2 DIR	65 3 CPHX 3 IMM	75 5 CPHX 2 DIR	85 1 TPA 1 INH	95 2 TSX 1 INH	A5 2 BIT 2 IMM	B5 3 BIT 2 DIR	C5 4 BIT 3 EXT	D5 4 BIT 3 IX2	E5 3 BIT 2 IX1	F5 3 BIT 1 IX				
06 5 BRSET3 3 DIR	16 5 BSET3 2 DIR	26 3 BNE 2 REL	36 5 ROR 2 DIR	46 1 RORA 1 INH	56 1 RORX 1 INH	66 5 ROR 2 IX1	76 4 ROR 1 IX	86 3 PULA 1 INH	96 5 STHX 3 EXT	A6 2 LDA 2 IMM	B6 3 LDA 2 DIR	C6 4 LDA 3 EXT	D6 4 LDA 3 IX2	E6 3 LDA 2 IX1	F6 3 LDA 1 IX				
07 5 BRCLR3 3 DIR	17 5 BCLR3 2 DIR	27 3 BEQ 2 REL	37 5 ASR 2 DIR	47 1 ASRA 1 INH	57 1 ASRX 1 INH	67 5 ASR 2 IX1	77 4 ASR 1 IX	87 2 PSHA 1 INH	97 1 TAX 1 INH	A7 2 AIS 2 IMM	B7 3 STA 2 DIR	C7 4 STA 3 EXT	D7 4 STA 3 IX2	E7 3 STA 2 IX1	F7 2 STA 1 IX				
08 5 BRSET4 3 DIR	18 5 BSET4 2 DIR	28 3 BHCC 2 REL	38 5 LSL 2 DIR	48 1 LSLA 1 INH	58 1 LSLX 1 INH	68 5 LSL 2 IX1	78 4 LSL 1 IX	88 3 PULX 1 INH	98 1 CLC 1 INH	A8 2 EOR 2 IMM	B8 3 EOR 2 DIR	C8 4 EOR 3 EXT	D8 4 EOR 3 IX2	E8 3 EOR 2 IX1	F8 3 EOR 1 IX				
09 5 BRCLR4 3 DIR	19 5 BCLR4 2 DIR	29 3 BHCS 2 REL	39 5 ROL 2 DIR	49 1 ROLA 1 INH	59 1 ROLX 1 INH	69 5 ROL 2 IX1	79 4 ROL 1 IX	89 2 PSHX 1 INH	99 1 SEC 1 INH	A9 2 ADC 2 IMM	B9 3 ADC 2 DIR	C9 4 ADC 3 EXT	D9 4 ADC 3 IX2	E9 3 ADC 2 IX1	F9 3 ADC 1 IX				
0A 5 BRSET5 3 DIR	1A 5 BSET5 2 DIR	2A 3 BPL 2 REL	3A 5 DEC 2 DIR	4A 1 DECA 1 INH	5A 1 DECX 1 INH	6A 5 DEC 2 IX1	7A 4 DEC 1 IX	8A 3 PULH 1 INH	9A 1 CLI 1 INH	AA 2 ORA 2 IMM	BA 3 ORA 2 DIR	CA 4 ORA 3 EXT	DA 4 ORA 3 IX2	EA 3 ORA 2 IX1	FA 3 ORA 1 IX				
0B 5 BRCLR5 3 DIR	1B 5 BCLR5 2 DIR	2B 3 BMI 2 REL	3B 7 DBNZ 3 DIR	4B 4 DBNZA 2 INH	5B 4 DBNZX 2 INH	6B 7 DBNZ 3 IX1	7B 6 DBNZ 2 IX	8B 2 PSHH 1 INH	9B 1 SEI 1 INH	AB 2 ADD 2 IMM	BB 3 ADD 2 DIR	CB 4 ADD 3 EXT	DB 4 ADD 3 IX2	EB 3 ADD 2 IX1	FB 3 ADD 1 IX				
0C 5 BRSET6 3 DIR	1C 5 BSET6 2 DIR	2C 3 BMC 2 REL	3C 5 INC 2 DIR	4C 1 INCA 1 INH	5C 1 INCX 1 INH	6C 5 INC 2 IX1	7C 4 INC 1 IX	8C 1 CLRH 1 INH	9C 1 RSP 1 INH	AC 8 CALL 4 EXT	BC 3 JMP 2 DIR	CC 4 JMP 3 EXT	DC 4 JMP 3 IX2	EC 3 JMP 2 IX1	FC 3 JMP 1 IX				
0D 5 BRCLR6 3 DIR	1D 5 BCLR6 2 DIR	2D 3 BMS 2 REL	3D 4 TST 2 DIR	4D 1 TSTA 1 INH	5D 1 TSTX 1 INH	6D 4 TST 2 IX1	7D 3 TST 1 IX	8D 7 RTC 1 INH	9D 1 NOP 1 INH	AD 5 BSR 2 REL	BD 5 JSR 2 DIR	CD 6 JSR 3 EXT	DD 6 JSR 3 IX2	ED 5 JSR 2 IX1	FD 5 JSR 1 IX				
0E 5 BRSET7 3 DIR	1E 5 BSET7 2 DIR	2E 3 BIL 2 REL	3E 6 CPHX 3 EXT	4E 5 MOV 3 DD	5E 5 MOV 2 DIX+	6E 4 MOV 3 IMD	7E 5 MOV 2 IX+D	8E 2+ STOP 1 INH	9E Page 2	AE 2 LDX 2 IMM	BE 3 LDX 2 DIR	CE 4 LDX 3 EXT	DE 4 LDX 3 IX2	EE 3 LDX 2 IX1	FE 3 LDX 1 IX				
0F 5 BRCLR7 3 DIR	1F 5 BCLR7 2 DIR	2F 3 BIH 2 REL	3F 5 CLR 2 DIR	4F 1 CLRA 1 INH	5F 1 CLR 1 INH	6F 5 CLR 2 IX1	7F 4 CLR 1 IX	8F 2+ WAIT 1 INH	9F 1 TXA 1 INH	AF 2 AIX 2 IMM	BF 3 STX 2 DIR	CF 4 STX 3 EXT	DF 4 STX 3 IX2	EF 3 STX 2 IX1	FF 2 STX 1 IX				

INH Inherent
 IMM Immediate
 DIR Direct
 EXT Extended
 DD DIR to DIR
 IX+D IX+ to DIR

REL Relative
 IX Indexed, No Offset
 IX1 Indexed, 8-Bit Offset
 IX2 Indexed, 16-Bit Offset
 IMM to DIR
 DIR to IX+

SP1 Stack Pointer, 8-Bit Offset
 SP2 Stack Pointer, 16-Bit Offset
 IX+ Indexed, No Offset with Post Increment
 IX1+ Indexed, 1-Byte Offset with Post Increment

Opcode in Hexadecimal F0 SUB 3
 Number of Bytes 1 IX
 HCS08 Cycles Instruction Mnemonic Addressing Mode

Table 7-3. Opcode Map (Sheet 2 of 2)

Bit-Manipulation	Branch	Read-Modify-Write			Control			Register/Memory						
				9E60 NEG 3 SP1						9ED0 SUB 4 SP2	9EE0 SUB 3 SP1			
				9E61 CBEQ 4 SP1						9ED1 CMP 4 SP2	9EE1 CMP 3 SP1			
										9ED2 SBC 4 SP2	9EE2 SBC 3 SP1			
				9E63 COM 3 SP1						9ED3 CPX 4 SP2	9EE3 CPX 3 SP1	9EF3 CPHX 3 SP1		
				9E64 LSR 3 SP1						9ED4 AND 4 SP2	9EE4 AND 3 SP1			
										9ED5 BIT 4 SP2	9EE5 BIT 3 SP1			
				9E66 ROR 3 SP1						9ED6 LDA 4 SP2	9EE6 LDA 3 SP1			
				9E67 ASR 3 SP1						9ED7 STA 4 SP2	9EE7 STA 3 SP1			
				9E68 LSL 3 SP1						9ED8 EOR 4 SP2	9EE8 EOR 3 SP1			
				9E69 ROL 3 SP1						9ED9 ADC 4 SP2	9EE9 ADC 3 SP1			
				9E6A DEC 3 SP1						9EDA ORA 4 SP2	9EEA ORA 3 SP1			
				9E6B DBNZ 4 SP1						9EDB ADD 4 SP2	9EEB ADD 3 SP1			
				9E6C INC 3 SP1										
				9E6D TST 3 SP1										
									9EAE LDHX 2 IX	9EBE LDHX 4 IX2	9ECE LDHX 3 IX1	9EDE LDX 4 SP2	9EEE LDX 3 SP1	9EFE LDHX 3 SP1
				9E6F CLR 3 SP1						9EDF STX 4 SP2	9EEF STX 3 SP1	9EFF STHX 3 SP1		

INH Inherent REL Relative SP1 Stack Pointer, 8-Bit Offset
 IMM Immediate IX Indexed, No Offset SP2 Stack Pointer, 16-Bit Offset
 DIR Direct IX1 Indexed, 8-Bit Offset IX+ Indexed, No Offset with
 EXT Extended IX2 Indexed, 16-Bit Offset Post Increment
 DD DIR to DIR IMD IMM to DIR IX1+ Indexed, 1-Byte Offset with
 IX+D IX+ to DIR DIX+ DIR to IX+ Post Increment

Note: All Sheet 2 Opcodes are Preceded by the Page 2 Prebyte (9E)

Prebyte (9E) and Opcode in Hexadecimal

9E60	6	HCS08 Cycles
NEG		Instruction Mnemonic
3	SP1	Addressing Mode

Number of Bytes

Chapter 8

Multi-Purpose Clock Generator (S08MCGV2)

8.1 Introduction

The multi-purpose clock generator (MCG) module provides several clock source choices for the MCU. The module contains a frequency-locked loop (FLL) and a phase-locked loop (PLL) that are controllable by either an internal or an external reference clock. The module can select either of the FLL or PLL clocks, or either of the internal or external reference clocks as a source for the MCU system clock. Whichever clock source is chosen, it is passed through a reduced bus divider which allows a lower output clock frequency to be derived. The MCG also controls an external oscillator (XOSC) for the use of a crystal or resonator as the external reference clock.

All devices in the MC9S08DZ128 Series feature the MCG module.

NOTE

Refer to [Section 1.3, “System Clock Distribution,”](#) for detailed view of the distribution of clock sources throughout the chip.

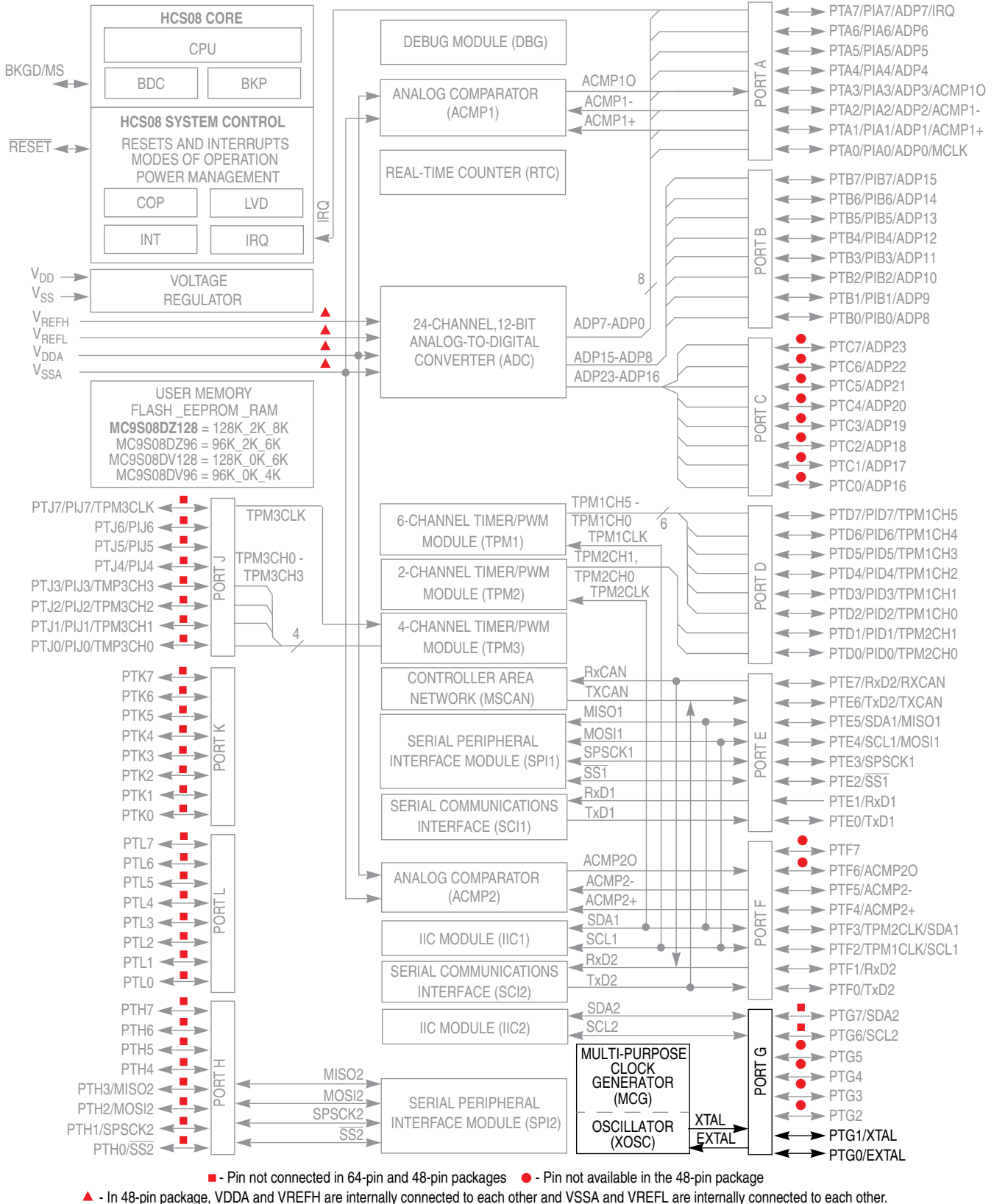

Figure 8-1. MC9S08DZ128 Block Diagram with MCG Highlighted

8.1.1 Features

Key features of the MCG module are:

- Frequency-locked loop (FLL)
 - Internal or external reference can be used to control the FLL
- Phase-locked loop (PLL)
 - Voltage-controlled oscillator (VCO)
 - Modulo VCO frequency divider
 - Phase/Frequency detector
 - Integrated loop filter
 - Lock detector with interrupt capability
- Internal reference clock
 - Nine trim bits for accuracy
 - Can be selected as the clock source for the MCU
- External reference clock
 - Control for external oscillator
 - Clock monitor with reset capability
 - Can be selected as the clock source for the MCU
- Reference divider is provided
- Clock source selected can be divided down by 1, 2, 4, or 8
- BDC clock (MCGLCLK) is provided as a constant divide by 2 of the DCO output whether in an FLL or PLL mode.
- Two selectable digitally controlled oscillators (DCOs) optimized for different frequency ranges.
- Option to maximize DCO output frequency for a 32,768 Hz external reference clock source.

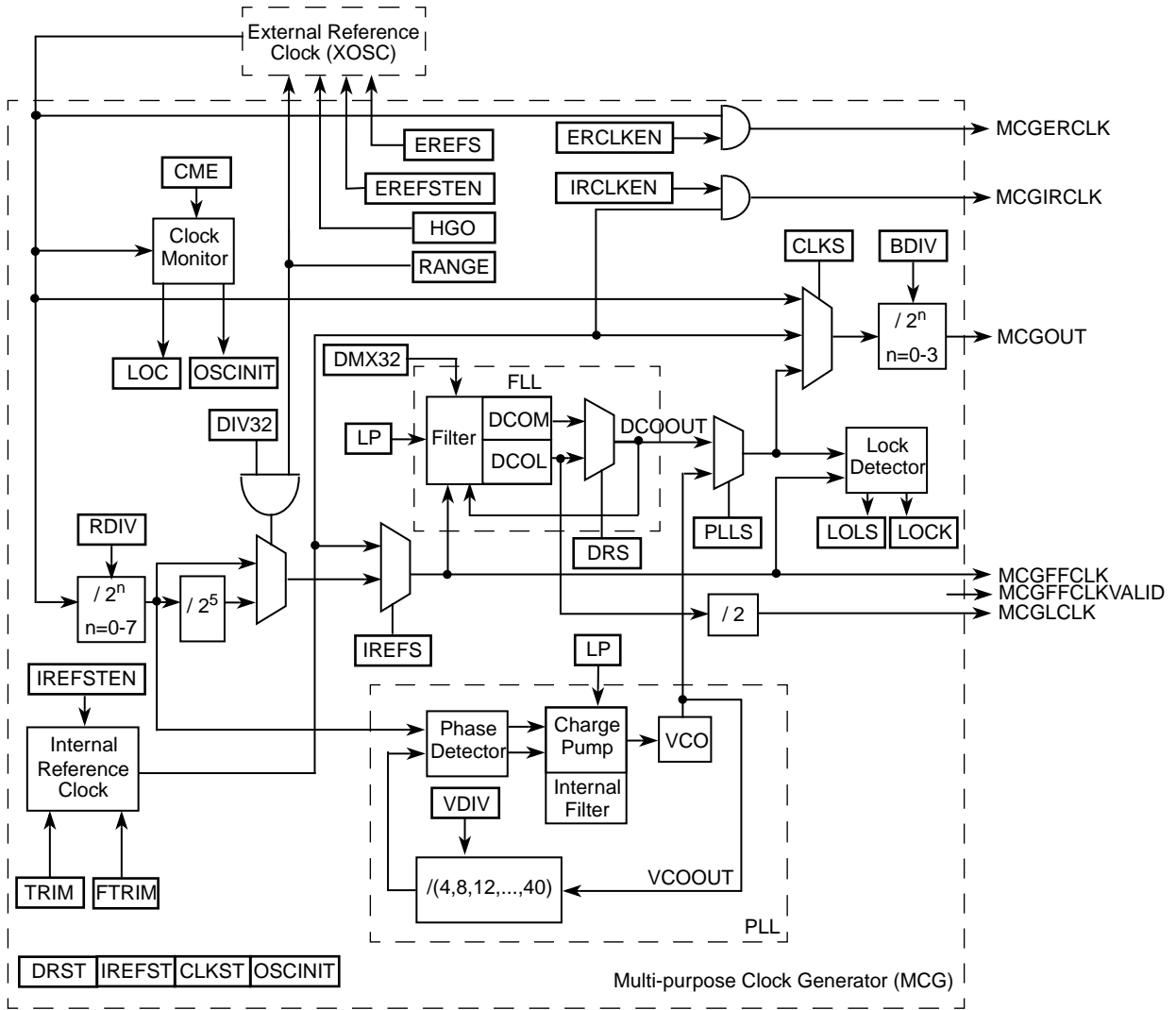

Figure 8-2. Multi-Purpose Clock Generator (MCG) Block Diagram

8.1.2 Modes of Operation

There are several modes of operation for the MCG:

- FLL Engaged Internal (FEI)
- FLL Engaged External (FEE)
- FLL Bypassed Internal (FBI)
- FLL Bypassed External (FBE)
- PLL Engaged External (PEE)
- PLL Bypassed External (PBE)
- Bypassed Low Power Internal (BLPI)
- Bypassed Low Power External (BLPE)
- Stop

For details see [Section 8.4.1, “Operational Modes.](#)

8.2 External Signal Description

There are no MCG signals that connect off chip.

8.3 Register Definition

8.3.1 MCG Control Register 1 (MCGC1)

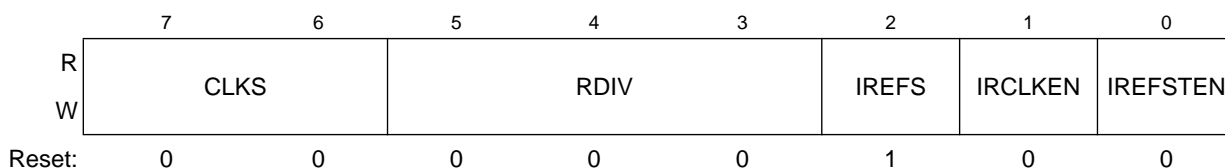

Figure 8-3. MCG Control Register 1 (MCGC1)

Table 8-1. MCG Control Register 1 Field Descriptions

Field	Description
7:6 CLKS	Clock Source Select — Selects the system clock source. 00 Encoding 0 — Output of FLL or PLL is selected. 01 Encoding 1 — Internal reference clock is selected. 10 Encoding 2 — External reference clock is selected. 11 Encoding 3 — Reserved, defaults to 00.
5:3 RDIV	External Reference Divider — Selects the amount to divide down the external reference clock. If the FLL is selected, the resulting frequency must be in the range 31.25 kHz to 39.0625 kHz. If the PLL is selected, the resulting frequency must be in the range 1 MHz to 2 MHz. See Table 8-2 and Table 8-3 for the divide-by factors.
2 IREFS	Internal Reference Select — Selects the reference clock source. 1 Internal reference clock selected 0 External reference clock selected
1 IRCLKEN	Internal Reference Clock Enable — Enables the internal reference clock for use as MCGIRCLK. 1 MCGIRCLK active 0 MCGIRCLK inactive
0 IREFSTEN	Internal Reference Stop Enable — Controls whether or not the internal reference clock remains enabled when the MCG enters stop mode. 1 Internal reference clock stays enabled in stop if IRCLKEN is set or if MCG is in FEI, FBI, or BLPI mode before entering stop 0 Internal reference clock is disabled in stop

Table 8-2. FLL External Reference Divide Factor

RDIV	Divide Factor		
	RANGE:DIV32 0:X	RANGE:DIV32 1:0	RANGE:DIV32 1:1
0	1	1	32
1	2	2	64
2	4	4	128
3	8	8	256
4	16	16	512
5	32	32	1024
6	64	64	Reserved
7	128	128	Reserved

Table 8-3. PLL External Reference Divide Factor

RDIV	Divide Factor
0	1
1	2
2	4
3	8
4	16
5	32
6	64
7	128

8.3.2 MCG Control Register 2 (MCGC2)

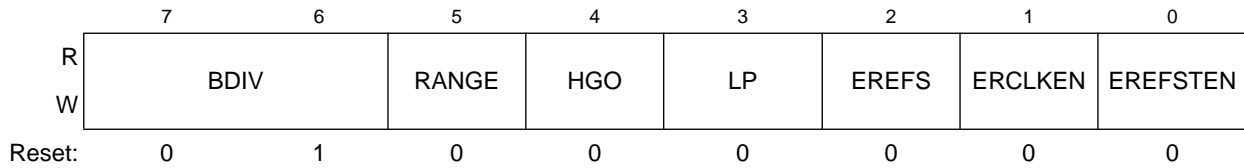

Figure 8-4. MCG Control Register 2 (MCGC2)

Table 8-4. MCG Control Register 2 Field Descriptions

Field	Description
7:6 BDIV	<p>Bus Frequency Divider — Selects the amount to divide down the clock source selected by the CLKS bits in the MCGC1 register. This controls the bus frequency.</p> <p>00 Encoding 0 — Divides selected clock by 1</p> <p>01 Encoding 1 — Divides selected clock by 2 (reset default)</p> <p>10 Encoding 2 — Divides selected clock by 4</p> <p>11 Encoding 3 — Divides selected clock by 8</p>
5 RANGE	<p>Frequency Range Select — Selects the frequency range for the external oscillator or external clock source.</p> <p>1 High frequency range selected for the external oscillator of 1 MHz to 16 MHz (1 MHz to 40 MHz for external clock source)</p> <p>0 Low frequency range selected for the external oscillator of 32 kHz to 100 kHz (32 kHz to 1 MHz for external clock source)</p>
4 HGO	<p>High Gain Oscillator Select — Controls the external oscillator mode of operation.</p> <p>1 Configure external oscillator for high gain operation</p> <p>0 Configure external oscillator for low power operation</p>
3 LP	<p>Low Power Select — Controls whether the FLL (or PLL) is disabled in bypassed modes.</p> <p>1 FLL (or PLL) is disabled in bypass modes (lower power).</p> <p>0 FLL (or PLL) is not disabled in bypass modes.</p>
2 EREFS	<p>External Reference Select — Selects the source for the external reference clock.</p> <p>1 Oscillator requested</p> <p>0 External Clock Source requested</p>
1 ERCLKEN	<p>External Reference Enable — Enables the external reference clock for use as MCGERCLK.</p> <p>1 MCGERCLK active</p> <p>0 MCGERCLK inactive</p>
0 EREFSTEN	<p>External Reference Stop Enable — Controls whether or not the external reference clock remains enabled when the MCG enters stop mode.</p> <p>1 External reference clock stays enabled in stop if ERCLKEN is set or if MCG is in FEE, FBE, PEE, PBE, or BLPE mode before entering stop</p> <p>0 External reference clock is disabled in stop</p>

8.3.3 MCG Trim Register (MCGTRM)

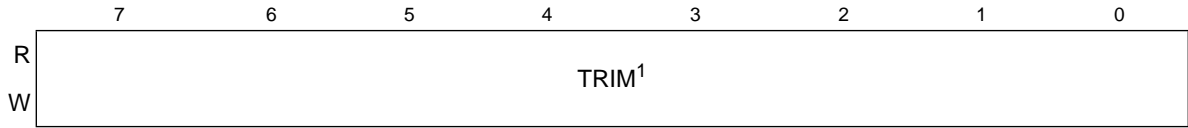

Figure 8-5. MCG Trim Register (MCGTRM)

¹ A value for TRIM is loaded during reset from a factory programmed location when not in any BDM mode. If in a BDM mode, a default value of 0x80 is loaded.

Table 8-5. MCG Trim Register Field Descriptions

Field	Description
7:0 TRIM	<p>MCG Trim Setting — Controls the internal reference clock frequency by controlling the internal reference clock period. The TRIM bits are binary weighted (i.e., bit 1 will adjust twice as much as bit 0). Increasing the binary value in TRIM will increase the period, and decreasing the value will decrease the period.</p> <p>An additional fine trim bit is available in MCGSC as the FTRIM bit.</p> <p>If a TRIM[7:0] value stored in nonvolatile memory is to be used, it's the user's responsibility to copy that value from the nonvolatile memory location to this register.</p>

8.3.4 MCG Status and Control Register (MCGSC)

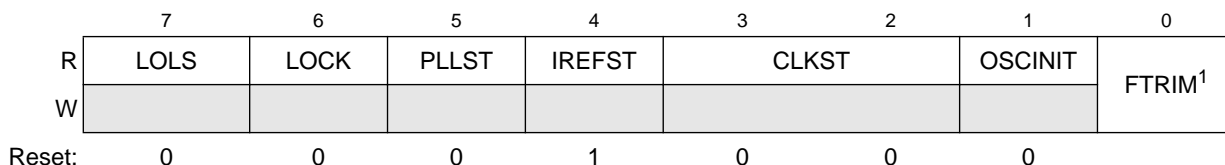

Figure 8-6. MCG Status and Control Register (MCGSC)

¹ A value for FTRIM is loaded during reset from a factory programmed location when not in any BDM mode. If in a BDM mode, a default value of 0x0 is loaded.

Table 8-6. MCG Status and Control Register Field Descriptions

Field	Description
7 LOLS	<p>Loss of Lock Status — This bit is a sticky indication of lock status for the FLL or PLL. LOLS is set when lock detection is enabled and after acquiring lock, the FLL or PLL output frequency has fallen outside the lock exit frequency tolerance, D_{unl}. LOLIE determines whether an interrupt request is made when set. LOLS is cleared by reset or by writing a logic 1 to LOLS when LOLS is set. Writing a logic 0 to LOLS has no effect.</p> <p>0 FLL or PLL has not lost lock since LOLS was last cleared. 1 FLL or PLL has lost lock since LOLS was last cleared.</p>
6 LOCK	<p>Lock Status — Indicates whether the FLL or PLL has acquired lock. Lock detection is disabled when both the FLL and PLL are disabled. If the lock status bit is set, changing the value of DMX32, DRS and IREFS bits in FBE, FBI, FEE and FEI modes; DIV32 bit in FBE and FEE modes; TRIM[7:0] bits in FBI and FEI modes; RDIV[2:0] bits in FBE, FEE, PBE and PEE modes; VDIV[3:0] bits in PBE and PEE modes; and PLLS bit, causes the lock status bit to clear and stay clear until the FLL or PLL has reacquired lock. Entry into BLPI, BLPE or stop mode also causes the lock status bit to clear and stay cleared until the exit of these modes and the FLL or PLL has reacquired lock.</p> <p>0 FLL or PLL is currently unlocked. 1 FLL or PLL is currently locked.</p>
5 PLLST	<p>PLL Select Status — The PLLST bit indicates the current source for the PLLS clock. The PLLST bit does not update immediately after a write to the PLLS bit due to internal synchronization between clock domains.</p> <p>0 Source of PLLS clock is FLL clock. 1 Source of PLLS clock is PLL clock.</p>
4 IREFST	<p>Internal Reference Status — The IREFST bit indicates the current source for the reference clock. The IREFST bit does not update immediately after a write to the IREFS bit due to internal synchronization between clock domains.</p> <p>0 Source of reference clock is external reference clock (oscillator or external clock source as determined by the IREFS bit in the MCGC2 register). 1 Source of reference clock is internal reference clock.</p>
3:2 CLKST	<p>Clock Mode Status — The CLKST bits indicate the current clock mode. The CLKST bits do not update immediately after a write to the CLKS bits due to internal synchronization between clock domains.</p> <p>00 Encoding 0 — Output of FLL is selected. 01 Encoding 1 — Internal reference clock is selected. 10 Encoding 2 — External reference clock is selected. 11 Encoding 3 — Output of PLL is selected.</p>

Table 8-6. MCG Status and Control Register Field Descriptions (continued)

Field	Description
1 OSCINIT	OSC Initialization — If the external reference clock is selected by ERCLKEN or by the MCG being in FEE, FBE, PEE, PBE, or BLPE mode, and if EREFS is set, then this bit is set after the initialization cycles of the external oscillator clock have completed. This bit is only cleared when either EREFS is cleared or when the MCG is in either FEI, FBI, or BLPI mode and ERCLKEN is cleared.
0 FTRIM	MCG Fine Trim — Controls the smallest adjustment of the internal reference clock frequency. Setting FTRIM will increase the period and clearing FTRIM will decrease the period by the smallest amount possible. If an FTRIM value stored in nonvolatile memory is to be used, it's the user's responsibility to copy that value from the nonvolatile memory location to this register's FTRIM bit.

8.3.5 MCG Control Register 3 (MCGC3)

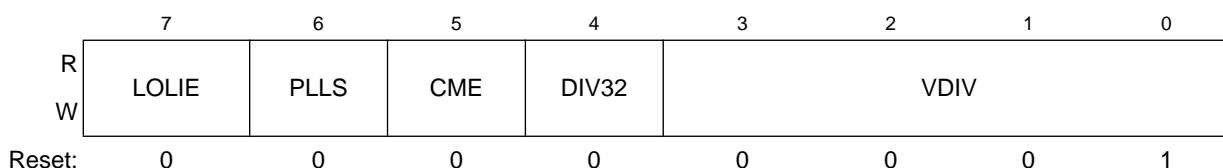
Figure 8-7. MCG Control Register 3 (MCGC3)
Table 8-7. MCG Control Register 3 Field Descriptions

Field	Description
7 LOLIE	Loss of Lock Interrupt Enable — Determines if an interrupt request is made following a loss of lock indication. The LOLIE bit only has an effect when LOLS is set. 0 No request on loss of lock. 1 Generate an interrupt request on loss of lock.
6 PLLS	PLL Select — Controls whether the PLL or FLL is selected. If the PLLS bit is clear, the PLL is disabled in all modes. If the PLLS is set, the FLL is disabled in all modes. 1 PLL is selected 0 FLL is selected
5 CME	Clock Monitor Enable — Determines if a reset request is made following a loss of external clock indication. The CME bit should only be set to a logic 1 when either the MCG is in an operational mode that uses the external clock (FEE, FBE, PEE, PBE, or BLPE) or the external reference is enabled (ERCLKEN=1 in the MCGC2 register). Whenever the CME bit is set to a logic 1, the value of the RANGE bit in the MCGC2 register should not be changed. 0 Clock monitor is disabled. 1 Generate a reset request on loss of external clock.

Table 8-7. MCG Control Register 3 Field Descriptions (continued)

Field	Description
4 DIV32	<p>Divide-by-32 Enable — Controls an additional divide-by-32 factor to the external reference clock for the FLL when RANGE bit is set. When the RANGE bit is 0, this bit has no effect. Writes to this bit are ignored if PLLS bit is set.</p> <p>0 Divide-by-32 is disabled. 1 Divide-by-32 is enabled when RANGE=1.</p>
3:0 VDIV	<p>VCO Divider — Selects the amount to divide down the VCO output of PLL. The VDIV bits establish the multiplication factor (M) applied to the reference clock frequency.</p> <p>0000 Encoding 0 — Reserved. 0001 Encoding 1 — Multiply by 4. 0010 Encoding 2 — Multiply by 8. 0011 Encoding 3 — Multiply by 12. 0100 Encoding 4 — Multiply by 16. 0101 Encoding 5 — Multiply by 20. 0110 Encoding 6 — Multiply by 24. 0111 Encoding 7 — Multiply by 28. 1000 Encoding 8 — Multiply by 32. 1001 Encoding 9 — Multiply by 36. 1010 Encoding 10 — Multiply by 40. 1011 Encoding 11 — Reserved (default to M=40). 11xx Encoding 12-15 — Reserved (default to M=40).</p>

8.3.6 MCG Test and Control Register (MCGT)

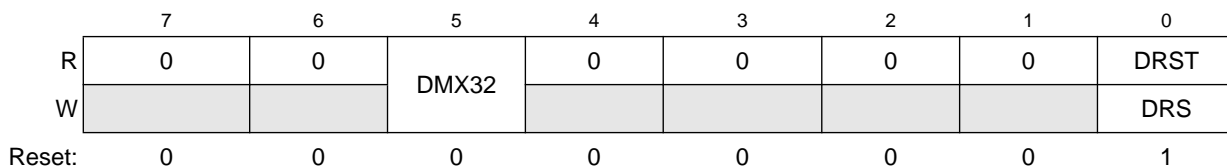

Figure 8-8. MCG Test and Control Register (MCGT)

Table 8-8. MCG Test and Control Register Field Descriptions

Field	Description
7:6	Reserved for test, user code should not write 1's to these bits.
5 DMX32	DCO Maximum frequency with 32.768 kHz reference — The DMX32 bit controls whether or not the DCO frequency range is narrowed to its maximum frequency with a 32.768 kHz reference. See Table 8-9. 0 DCO has default range of 25%. 1 DCO is fined tuned for maximum frequency with 32.768 kHz reference.
4:1	Reserved for test, user code should not write 1's to these bits.
0 DRST DRS	DCO Range Status — The DRST read bit indicates the current frequency range for the FLL output, DCOOUT. See Table 8-9. The DRST bit does not update immediately after a write to the DRS field due to internal synchronization between clock domains. The DRST bit is not valid in BLPI, BLPE, PBE or PEE mode and it reads zero regardless of the DCO range selected by the DRS bit. DCO Range Select — The DRS bit selects the frequency range for the FLL output, DCOOUT. Writes to the DRS bit while either the LP or PLLS bit is set are ignored. 0 Low range. 1 Mid range.

Table 8-9. DCO frequency range¹

DRS	DMX32	Reference range	FLL factor	DCO range
0	0	31.25 - 39.0625 kHz	512	16 - 20 MHz
	1	32.768 kHz	608	19.92 MHz
1	0	31.25 - 39.0625 kHz	1024	32 - 40 MHz
	1	32.768 kHz	1216	39.85 MHz

¹ The resulting bus clock frequency should not exceed the maximum specified bus clock frequency of the device.

8.4 Functional Description

8.4.1 Operational Modes

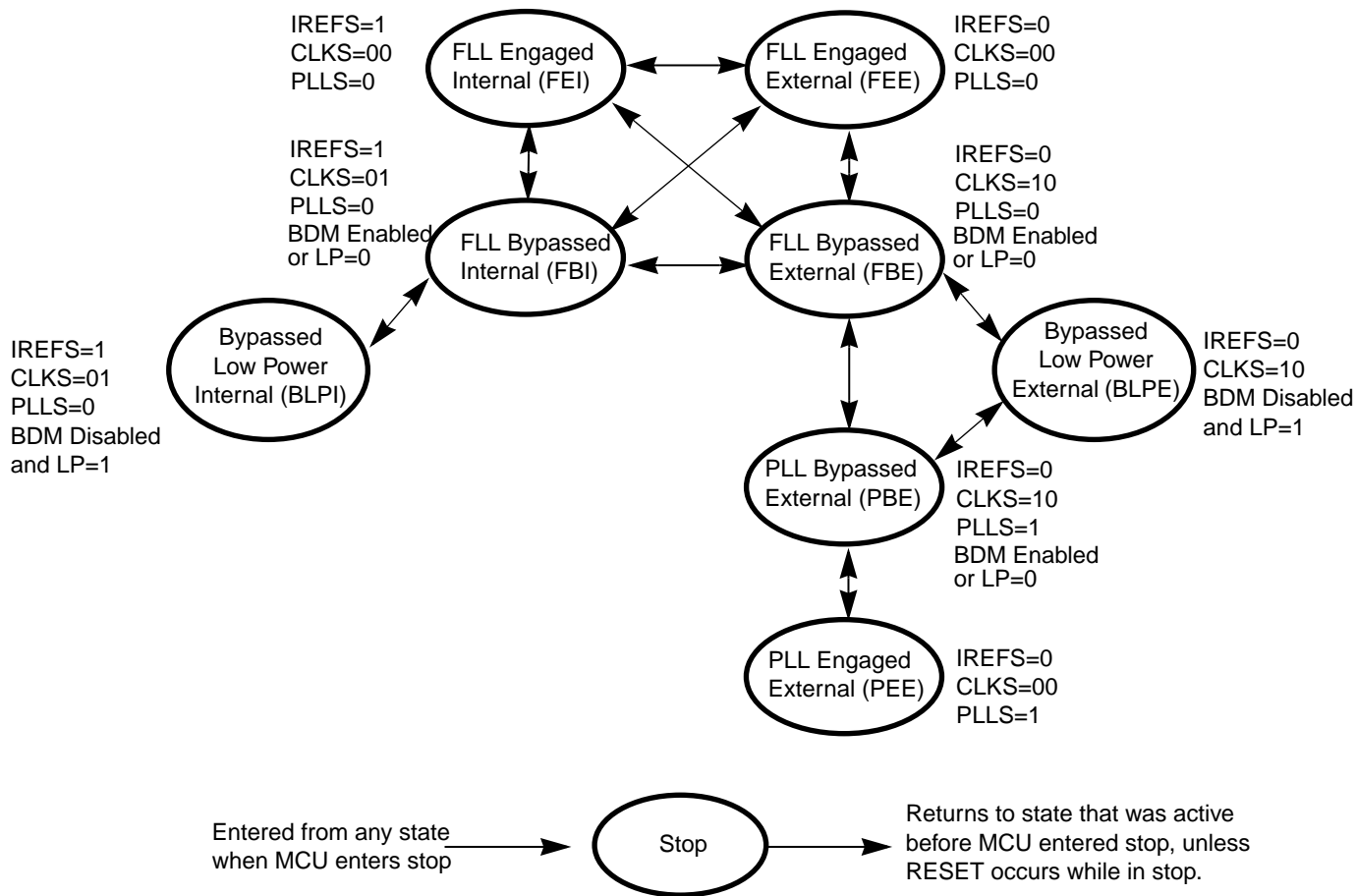

Figure 8-9. Clock Switching Modes

The nine states of the MCG are shown as a state diagram and are described below. The arrows indicate the allowed movements between the states.

8.4.1.1 FLL Engaged Internal (FEI)

FLL engaged internal (FEI) is the default mode of operation and is entered when all the following conditions occur:

- CLKS bits are written to 00
- IREFS bit is written to 1
- PLLS bit is written to 0

In FLL engaged internal mode, the MCGOUT clock is derived from the FLL clock, which is controlled by the internal reference clock. The FLL clock frequency locks to a multiplication factor, as selected by the DRS and DMX32 bits, times the internal reference frequency. The MCGLCLK is derived from the FLL and the PLL is disabled in a low power state.

8.4.1.2 FLL Engaged External (FEE)

The FLL engaged external (FEE) mode is entered when all the following conditions occur:

- CLKS bits are written to 00
- IREFS bit is written to 0
- PLLS bit is written to 0
- RDIV bits are written to divide reference clock to be within the range of 31.25 kHz to 39.0625 kHz

In FLL engaged external mode, the MCGOUT clock is derived from the FLL clock which is controlled by the external reference clock. The external reference clock which is enabled can be an external crystal/resonator or it can be another external clock source. The FLL clock frequency locks to a multiplication factor, as selected by the DRS and DMX32 bits, times the external reference frequency, as selected by the RDIV, RANGE and DIV32 bits. The MCGLCLK is derived from the FLL and the PLL is disabled in a low power state.

8.4.1.3 FLL Bypassed Internal (FBI)

In FLL bypassed internal (FBI) mode, the MCGOUT clock is derived from the internal reference clock and the FLL is operational but its output clock is not used. This mode is useful to allow the FLL to acquire its target frequency while the MCGOUT clock is driven from the internal reference clock.

The FLL bypassed internal mode is entered when all the following conditions occur:

- CLKS bits are written to 01
- IREFS bit is written to 1
- PLLS bit is written to 0
- LP bit is written to 0

In FLL bypassed internal mode, the MCGOUT clock is derived from the internal reference clock. The FLL clock is controlled by the internal reference clock, and the FLL clock frequency locks to a multiplication

factor, as selected by the DRS and DMX32 bits, times the internal reference frequency. The MCGLCLK is derived from the FLL and the PLL is disabled in a low power state.

8.4.1.4 FLL Bypassed External (FBE)

In FLL bypassed external (FBE) mode, the MCGOUT clock is derived from the external reference clock and the FLL is operational but its output clock is not used. This mode is useful to allow the FLL to acquire its target frequency while the MCGOUT clock is driven from the external reference clock.

The FLL bypassed external mode is entered when all the following conditions occur:

- CLKS bits are written to 10
- IREFS bit is written to 0
- PLLS bit is written to 0
- RDIV bits are written to divide reference clock to be within the range of 31.25 kHz to 39.0625 kHz
- LP bit is written to 0

In FLL bypassed external mode, the MCGOUT clock is derived from the external reference clock. The external reference clock which is enabled can be an external crystal/resonator or it can be another external clock source. The FLL clock is controlled by the external reference clock, and the FLL clock frequency locks to a multiplication factor, as selected by the DRS and DMX32 bits, times the external reference frequency, as selected by the RDIV, RANGE and DIV32 bits. The MCGLCLK is derived from the FLL and the PLL is disabled in a low power state.

8.4.1.5 PLL Engaged External (PEE)

The PLL engaged external (PEE) mode is entered when all the following conditions occur:

- CLKS bits are written to 00
- IREFS bit is written to 0
- PLLS bit is written to 1
- RDIV bits are written to divide reference clock to be within the range of 1 MHz to 2 MHz

In PLL engaged external mode, the MCGOUT clock is derived from the PLL clock which is controlled by the external reference clock. The external reference clock which is enabled can be an external crystal/resonator or it can be another external clock source. The PLL clock frequency locks to a multiplication factor, as selected by the VDIV bits, times the external reference frequency, as selected by the RDIV, RANGE and DIV32 bits. If BDM is enabled then the MCGLCLK is derived from the DCO (open-loop mode) divided by two. If BDM is not enabled then the FLL is disabled in a low power state.

In this mode, the DRST bit reads 0 regardless of whether the DRS bit is set to 1 or 0.

8.4.1.6 PLL Bypassed External (PBE)

In PLL bypassed external (PBE) mode, the MCGOUT clock is derived from the external reference clock and the PLL is operational but its output clock is not used. This mode is useful to allow the PLL to acquire its target frequency while the MCGOUT clock is driven from the external reference clock.

The PLL bypassed external mode is entered when all the following conditions occur:

- CLKS bits are written to 10
- IREFS bit is written to 0
- PLLS bit is written to 1
- RDIV bits are written to divide reference clock to be within the range of 1 MHz to 2 MHz
- LP bit is written to 0

In PLL bypassed external mode, the MCGOUT clock is derived from the external reference clock. The external reference clock which is enabled can be an external crystal/resonator or it can be another external clock source. The PLL clock frequency locks to a multiplication factor, as selected by the VDIV bits, times the external reference frequency, as selected by the RDIV, RANGE and DIV32 bits. If BDM is enabled then the MCGLCLK is derived from the DCO (open-loop mode) divided by two. If BDM is not enabled then the FLL is disabled in a low power state.

In this mode, the DRST bit reads 0 regardless of whether the DRS bit is set to 1 or 0.

8.4.1.7 Bypassed Low Power Internal (BLPI)

The bypassed low power internal (BLPI) mode is entered when all the following conditions occur:

- CLKS bits are written to 01
- IREFS bit is written to 1
- PLLS bit is written to 0
- LP bit is written to 1
- BDM mode is not active

In bypassed low power internal mode, the MCGOUT clock is derived from the internal reference clock.

The PLL and the FLL are disabled at all times in BLPI mode and the MCGLCLK will not be available for BDC communications. If the BDM becomes active the mode will switch to FLL bypassed internal (FBI) mode.

In this mode, the DRST bit reads 0 regardless of whether the DRS bit is set to 1 or 0.

8.4.1.8 Bypassed Low Power External (BLPE)

The bypassed low power external (BLPE) mode is entered when all the following conditions occur:

- CLKS bits are written to 10
- IREFS bit is written to 0
- PLLS bit is written to 0 or 1
- LP bit is written to 1

- BDM mode is not active

In bypassed low power external mode, the MCGOUT clock is derived from the external reference clock. The external reference clock which is enabled can be an external crystal/resonator or it can be another external clock source.

The PLL and the FLL are disabled at all times in BLPE mode and the MCGLCLK will not be available for BDC communications. If the BDM becomes active the mode will switch to one of the bypassed external modes as determined by the state of the PLLS bit.

In this mode, the DRST bit reads 0 regardless of whether the DRS bit is set to 1 or 0.

8.4.1.9 Stop

Stop mode is entered whenever the MCU enters a STOP state. In this mode, the FLL and PLL are disabled and all MCG clock signals are static except in the following cases:

MCGIRCLK will be active in stop mode when all the following conditions occur:

- IRCLKEN = 1
- IREFSTEN = 1

MCGERCLK will be active in stop mode when all the following conditions occur:

- ERCLKEN = 1
- EREFSTEN = 1

8.4.2 Mode Switching

The IREFS bit can be changed at anytime, but the actual switch to the newly selected clock is shown by the IREFST bit. When switching between engaged internal and engaged external modes, the FLL or PLL will begin locking again after the switch is completed.

For the special case of entering stop mode immediately after switching to FBE mode, if the external clock and the internal clock are disabled in stop mode, (EREFSTEN = 0 and IREFSTEN = 0), it is necessary to allow 100us after the IREFST bit is cleared to allow the internal reference to shutdown. For most cases the delay due to instruction execution times will be sufficient.

The CLKS bits can also be changed at anytime, but the actual switch to the newly selected clock is shown by the CLKST bits. If the newly selected clock is not available, the previous clock will remain selected.

The DRS bits can be changed at anytime except when LP bit is 1. If the DRS bits are changed while in FLL engaged internal (FEI) or FLL engaged external (FEE), the bus clock remains at the previous DCO range until the new DCO starts. When the new DCO starts the bus clock switches to it. After switching to the new DCO the FLL remains unlocked for several reference cycles. Once the selected DCO startup time is over, the FLL is locked. The completion of the switch is shown by the DRST bits.

For details see [Figure 8-9](#).

8.4.3 Bus Frequency Divider

The BDIV bits can be changed at anytime and the actual switch to the new frequency will occur immediately.

8.4.4 Low Power Bit Usage

The low power bit (LP) is provided to allow the FLL or PLL to be disabled and thus conserve power when these systems are not being used. The DRS bit can not be written while LP bit is 1. However, in some applications it may be desirable to enable the FLL or PLL and allow it to lock for maximum accuracy before switching to an engaged mode. Do this by writing the LP bit to 0.

8.4.5 Internal Reference Clock

When IRCLKEN is set the internal reference clock signal will be presented as MCGIRCLK, which can be used as an additional clock source. The MCGIRCLK frequency can be re-targeted by trimming the period of the internal reference clock. This can be done by writing a new value to the TRIM bits in the MCGTRM register. Writing a larger value will decrease the MCGIRCLK frequency, and writing a smaller value to the MCGTRM register will increase the MCGIRCLK frequency. The TRIM bits will effect the MCGOUT frequency if the MCG is in FLL engaged internal (FEI), FLL bypassed internal (FBI), or bypassed low power internal (BLPI) mode. The TRIM and FTRIM value is initialized by POR but is not affected by other resets.

Until MCGIRCLK is trimmed, programming low reference divider (RDIV) factors may result in MCGOUT frequencies that exceed the maximum chip-level frequency and violate the chip-level clock timing specifications (see the [Device Overview](#) chapter).

If IREFSTEN and IRCLKEN bits are both set, the internal reference clock will keep running during stop mode in order to provide a fast recovery upon exiting stop.

8.4.6 External Reference Clock

The MCG module can support an external reference clock with frequencies between 31.25 kHz to 40 MHz in all modes. When ERCLKEN is set, the external reference clock signal will be presented as MCGERCLK, which can be used as an additional clock source. When IREFS = 1, the external reference clock will not be used by the FLL or PLL and will only be used as MCGERCLK. In these modes, the frequency can be equal to the maximum frequency the chip-level timing specifications will support (see the [Device Overview](#) chapter).

If EREFSTEN and ERCLKEN bits are both set or the MCG is in FEE, FBE, PEE, PBE or BLPE mode, the external reference clock will keep running during stop mode in order to provide a fast recovery upon exiting stop.

If CME bit is written to 1, the clock monitor is enabled. If the external reference falls below a certain frequency (f_{loc_high} or f_{loc_low} depending on the RANGE bit in the MCGC2), the MCU will reset. The LOC bit in the System Reset Status (SRS) register will be set to indicate the error.

8.4.7 Fixed Frequency Clock

The MCG presents the divided reference clock as MCGFFCLK for use as an additional clock source. The MCGFFCLK frequency must be no more than 1/4 of the MCGOUT frequency to be valid. When MCGFFCLK is valid then MCGFFCLKVALID is set to 1. When MCGFFCLK is not valid then MCGFFCLKVALID is set to 0.

8.5 Initialization / Application Information

This section describes how to initialize and configure the MCG module in application. The following sections include examples on how to initialize the MCG and properly switch between the various available modes.

8.5.1 MCG Module Initialization Sequence

The MCG comes out of reset configured for FEI mode with the BDIV set for divide-by-2. The internal reference will stabilize in t_{irefst} microseconds before the FLL can acquire lock. As soon as the internal reference is stable, the FLL will acquire lock in $t_{\text{fl}_\text{acquire}}$ milliseconds.

NOTE

If the internal reference is not already trimmed, the BDIV value should not be changed to divide-by-1 without first trimming the internal reference. Failure to do so could result in the MCU running out of specification.

8.5.1.1 Initializing the MCG

Because the MCG comes out of reset in FEI mode, the only MCG modes which can be directly switched to upon reset are FEE, FBE, and FBI modes (see [Figure 8-9](#)). Reaching any of the other modes requires first configuring the MCG for one of these three initial modes. Care must be taken to check relevant status bits in the MCGSC register reflecting all configuration changes within each mode.

To change from FEI mode to FEE or FBE modes, follow this procedure:

1. Enable the external clock source by setting the appropriate bits in MCGC2.
2. If the RANGE bit (bit 5) in MCGC2 is set, set DIV32 in MCGC3 to allow access to the proper RDIV values.
3. Write to MCGC1 to select the clock mode.
 - If entering FEE mode, set RDIV appropriately, clear the IREFS bit to switch to the external reference, and leave the CLKS bits at %00 so that the output of the FLL is selected as the system clock source.
 - If entering FBE, clear the IREFS bit to switch to the external reference and change the CLKS bits to %10 so that the external reference clock is selected as the system clock source. The RDIV bits should also be set appropriately here according to the external reference frequency because although the FLL is bypassed, it is still on in FBE mode.
 - The internal reference can optionally be kept running by setting the IRCLKEN bit. This is useful if the application will switch back and forth between internal and external modes. For minimum power consumption, leave the internal reference disabled while in an external clock mode.
4. Once the proper configuration bits have been set, wait for the affected bits in the MCGSC register to be changed appropriately, reflecting that the MCG has moved into the proper mode.

- If ERCLKEN was set in step 1 or the MCG is in FEE, FBE, PEE, PBE, or BLPE mode, and EREFS was also set in step 1, wait here for the OSCINIT bit to become set indicating that the external clock source has finished its initialization cycles and stabilized. Typical crystal startup times are given in Appendix A, “Electrical Characteristics”.
 - If in FEE mode, check to make sure the IREFST bit is cleared and the LOCK bit is set before moving on.
 - If in FBE mode, check to make sure the IREFST bit is cleared, the LOCK bit is set, and the CLKST bits have changed to %10 indicating the external reference clock has been appropriately selected. Although the FLL is bypassed in FBE mode, it is still on and will lock in FBE mode.
5. Write to the MCGT register to determine the DCO output (MCGOUT) frequency range.
 - By default, with DMX32 (bit 5) cleared to 0, the FLL multiplier for the DCO output is 1024. For greater flexibility, if a mid-range FLL multiplier of 512 is desired instead, clear the DRS bit (bit 0) to 0 for a DCO output frequency of 16.78 MHz.
 - When using a 32.768 kHz external reference, if the maximum mid-range DCO frequency that can be achieved with a 32.768 kHz reference is desired, clear the DRS bit (bit 0) to 0 and set the DMX32 bit (bit 5) to 1. The resulting DCO output (MCGOUT) frequency with the new multiplier of 608 will be 19.92 MHz.
 - When using a 32.768 kHz external reference, if the maximum high-range DCO frequency that can be achieved with a 32.768 kHz reference is desired, set the DRS bit (bit 0) to 1 and set the DMX32 bit (bit 5) to 1. The resulting DCO output (MCGOUT) frequency with the new multiplier of 1216 will be 39.85 MHz.
 6. Wait for the LOCK bit in MCGSC to become set, indicating that the FLL has locked to the new multiplier value designated by the DRS and DMX32 bits.

NOTE

Setting DIV32 (bit 4) in MCGC3 is strongly recommended for FLL external modes when using a high frequency range (RANGE = 1) external reference clock. The DIV32 bit is ignored in all other modes.

To change from FEI clock mode to FBI clock mode, follow this procedure:

1. Change the CLKS bits in MCGC1 to %01 so that the internal reference clock is selected as the system clock source.
2. Wait for the CLKST bits in the MCGSC register to change to %01, indicating that the internal reference clock has been appropriately selected.

8.5.2 Using a 32.768 kHz Reference

In FEE and FBE modes, if using a 32.768 kHz external reference, at the default FLL multiplication factor of 1024, the DCO output (MCGOUT) frequency is 33.55 MHz at high-range. If DRS is cleared to 0, the multiplication factor is halved to 512, and the resulting DCO output frequency is 16.78 Mhz at mid-range.

Setting the DMX32 bit in MCGT to 1 increases the FLL multiplication factor to allow the 32.768 kHz reference to achieve its maximum DCO output frequency. When the DRS bit is set, the 32.768 kHz

reference can achieve a high-range maximum DCO output of 39.85 MHz with a multiplier of 1216. When the DRS bit is clear, the 32.768 kHz reference can achieve a mid-range maximum DCO output of 19.92 MHz with a multiplier of 608.

In FBI and FEI modes, setting the DMX32 bit is not recommended. If the internal reference is trimmed to a frequency above 32.768 kHz, the greater FLL multiplication factor could potentially push the microcontroller system clock out of specification and damage the part.

8.5.3 MCG Mode Switching

When switching between operational modes of the MCG, certain configuration bits must be changed in order to properly move from one mode to another. Each time any of these bits are changed (PLLS, IREFS, CLKS, or EREFS), the corresponding bits in the MCGSC register (PLLST, IREFST, CLKST, or OSCINIT) must be checked before moving on in the application software.

Additionally, care must be taken to ensure that the reference clock divider (RDIV) is set properly for the mode being switched to. For instance, in PEE mode, if using a 4 MHz crystal, RDIV must be set to %001 (divide-by-2) or %010 (divide -by-4) in order to divide the external reference down to the required frequency between 1 and 2 MHz.

If switching to FBE or FEE mode, first setting the DIV32 bit will ensure a proper reference frequency is sent to the FLL clock at all times.

In FBE, FEE, FBI, and FEI modes, at any time, the application can switch the FLL multiplication factor between 1024 and 512 with the DRS bit in MCGT. Writes to DRS will be ignored if LP=1 or PLLS=1.

The RDIV and IREFS bits should always be set properly before changing the PLLS bit so that the FLL or PLL clock has an appropriate reference clock frequency to switch to. The table below shows MCGOUT frequency calculations using RDIV, BDIV, and VDIV settings for each clock mode. The bus frequency is equal to MCGOUT divided by 2.

Table 8-10. MCGOUT Frequency Calculation Options

Clock Mode	f_{MCGOUT}^1	Note
FEI (FLL engaged internal)	$(f_{int} * F) / B$	Typical $f_{MCGOUT} = 16$ MHz immediately after reset.
FEE (FLL engaged external)	$(f_{ext} / R * F) / B$	f_{ext} / R must be in the range of 31.25 kHz to 39.0625 kHz
FBE (FLL bypassed external)	f_{ext} / B	f_{ext} / R must be in the range of 31.25 kHz to 39.0625 kHz
FBI (FLL bypassed internal)	f_{int} / B	Typical $f_{int} = 32$ kHz
PEE (PLL engaged external)	$[(f_{ext} / R) * M] / B$	f_{ext} / R must be in the range of 1 MHz to 2 MHz
PBE (PLL bypassed external)	f_{ext} / B	f_{ext} / R must be in the range of 1 MHz to 2 MHz
BLPI (Bypassed low power internal)	f_{int} / B	
BLPE (Bypassed low power external)	f_{ext} / B	

- ¹ R is the reference divider selected by the RDIV bits, B is the bus frequency divider selected by the BDIV bits, F is the FLL factor selected by the DRS and DMX32 bits, and M is the multiplier selected by the VDIV bits.

This section will include 3 mode switching examples using an 8 MHz external crystal. If using an external clock source less than 1 MHz, the MCG should not be configured for any of the PLL modes (PEE and PBE).

8.5.3.1 Example # 1: Moving from FEI to PEE Mode: External Crystal = 8 MHz, Bus Frequency = 16 MHz

In this example, the MCG will move through the proper operational modes from FEI to PEE mode until the 8 MHz crystal reference frequency is set to achieve a bus frequency of 16 MHz. Because the MCG is in FEI mode out of reset, this example also shows how to initialize the MCG for PEE mode out of reset. First, the code sequence will be described. Then a flowchart will be included which illustrates the sequence.

1. First, FEI must transition to FBE mode:
 - a) MCGC2 = 0x36 (%00110110)
 - BDIV (bits 7 and 6) set to %00, or divide-by-1
 - RANGE (bit 5) set to 1 because the frequency of 8 MHz is within the high frequency range
 - HGO (bit 4) set to 1 to configure external oscillator for high gain operation
 - EREFS (bit 2) set to 1, because a crystal is being used
 - ERCLKEN (bit 1) set to 1 to ensure the external reference clock is active
 - b) Loop until OSCINIT (bit 1) in MCGSC is 1, indicating the crystal selected by the EREFS bit has been initialized.
 - c) Because RANGE = 1, set DIV32 (bit 4) in MCGC3 to allow access to the proper RDIV bits while in an FLL external mode.
 - d) MCGC1 = 0x98 (%10011000)
 - CLKS (bits 7 and 6) set to %10 in order to select external reference clock as system clock source
 - RDIV (bits 5-3) set to %011, or divide-by-256 because $8\text{MHz} / 256 = 31.25\text{ kHz}$ which is in the 31.25 kHz to 39.0625 kHz range required by the FLL
 - IREFS (bit 2) cleared to 0, selecting the external reference clock
 - e) Loop until IREFST (bit 4) in MCGSC is 0, indicating the external reference is the current source for the reference clock
 - f) Loop until CLKST (bits 3 and 2) in MCGSC is %10, indicating that the external reference clock is selected to feed MCGOUT

2. Then, FBE must transition either directly to PBE mode or first through BLPE mode and then to PBE mode:

- a) BLPE: If a transition through BLPE mode is desired, first set LP (bit 3) in MCGC2 to 1.
 - b) BLPE/PBE: MCGC3 = 0x58 (%01011000)
 - PLLS (bit 6) set to 1, selects the PLL. At this time, with an RDIV value of %011, the FLL reference divider of 256 is switched to the PLL reference divider of 8 (see Table 8-3), resulting in a reference frequency of 8 MHz/ 8 = 1 MHz. In BLPE mode, changing the PLLS bit only prepares the MCG for PLL usage in PBE mode
 - DIV32 (bit 4) still set at 1. Because the MCG is in a PLL mode, the DIV32 bit is ignored. Keeping it set at 1 makes transitions back into an FLL external mode easier.
 - VDIV (bits 3-0) set to %1000, or multiply-by-32 because 1 MHz reference * 32= 32MHz. In BLPE mode, the configuration of the VDIV bits does not matter because the PLL is disabled. Changing them only sets up the multiply value for PLL usage in PBE mode
 - c) BLPE: If transitioning through BLPE mode, clear LP (bit 3) in MCGC2 to 0 here to switch to PBE mode
 - d) PBE: Loop until PLLST (bit 5) in MCGSC is set, indicating that the current source for the PLLS clock is the PLL
 - e) PBE: Then loop until LOCK (bit 6) in MCGSC is set, indicating that the PLL has acquired lock
3. Lastly, PBE mode transitions into PEE mode:
- a) MCGC1 = 0x18 (%00011000)
 - CLKS (bits 7 and 6) in MCGSC1 set to %00 in order to select the output of the PLL as the system clock source
 - b) Loop until CLKST (bits 3 and 2) in MCGSC are %11, indicating that the PLL output is selected to feed MCGOUT in the current clock mode
 - Now, With an RDIV of divide-by-8, a BDIV of divide-by-1, and a VDIV of multiply-by-32, $MCGOUT = [(8 \text{ MHz} / 8) * 32] / 1 = 32 \text{ MHz}$, and the bus frequency is $MCGOUT / 2$, or 16 MHz

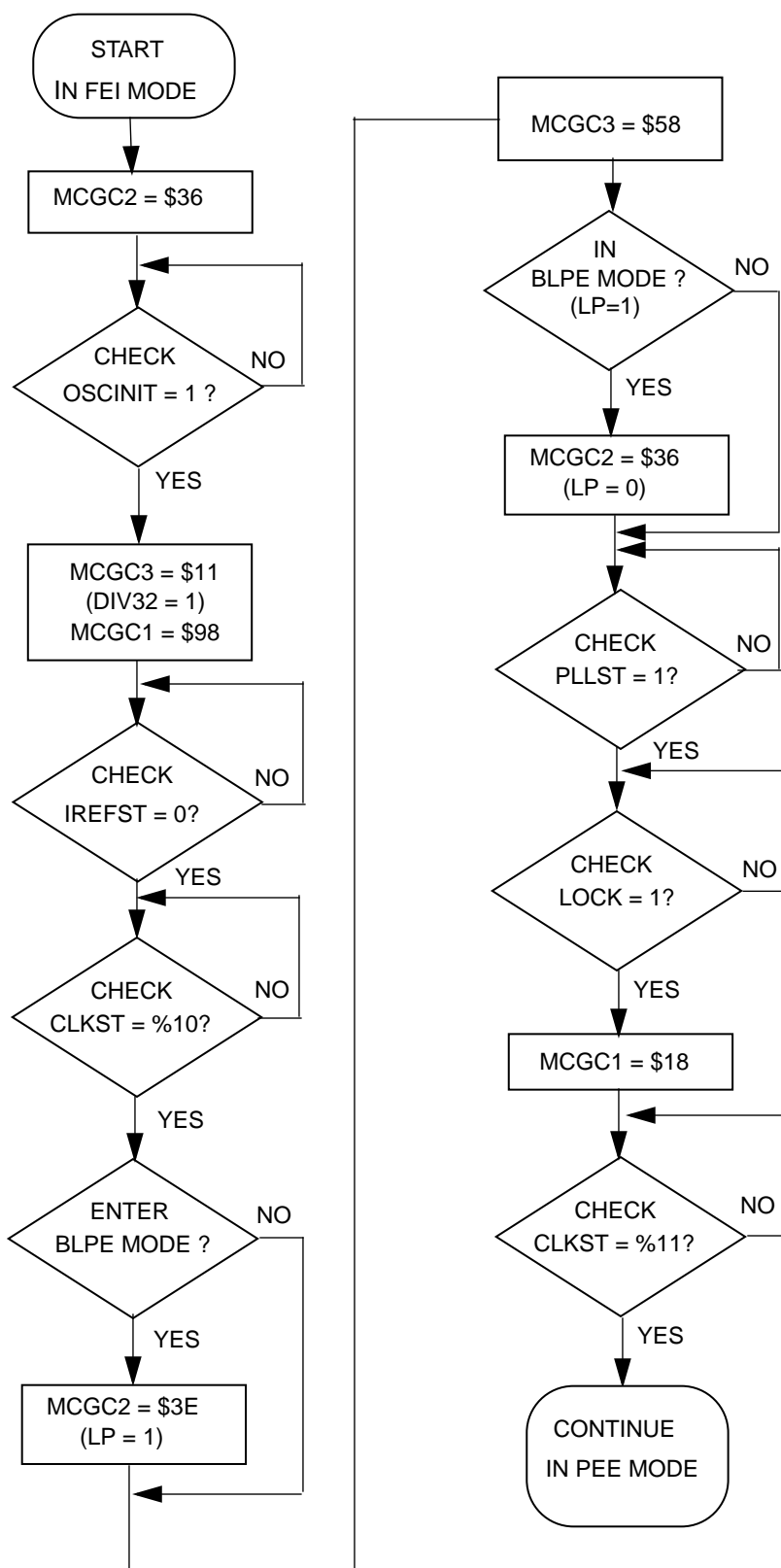

Figure 8-10. Flowchart of FEI to PEE Mode Transition using an 8 MHz crystal

8.5.3.2 Example # 2: Moving from PEE to BLPI Mode: Bus Frequency =16 kHz

In this example, the MCG will move through the proper operational modes from PEE mode with an 8MHz crystal configured for an 16 MHz bus frequency (see previous example) to BLPI mode with a 16 kHz bus frequency. First, the code sequence will be described. Then a flowchart will be included which illustrates the sequence.

1. First, PEE must transition to PBE mode:
 - a) MCGC1 = 0x98 (%10011000)
 - CLKs (bits 7 and 6) set to %10 in order to switch the system clock source to the external reference clock
 - b) Loop until CLKST (bits 3 and 2) in MCGSC are %10, indicating that the external reference clock is selected to feed MCGOUT

2. Then, PBE must transition either directly to FBE mode or first through BLPE mode and then to FBE mode:
 - a) BLPE: If a transition through BLPE mode is desired, first set LP (bit 3) in MCGC2 to 1
 - b) BLPE/FBE: MCGC3 = 0x18(%00011000)
 - PLLS (bit 6) clear to 0 to select the FLL. At this time, with an RDIV value of %011, the PLL reference divider of 8 is switched to an FLL divider of 256 (see Table 8-2), resulting in a reference frequency of $8 \text{ MHz} / 256 = 31.25 \text{ kHz}$. If RDIV was not previously set to %011 (necessary to achieve required 31.25-39.06 kHz FLL reference frequency with an 8 MHz external source frequency), it must be changed prior to clearing the PLLS bit. In BLPE mode, changing this bit only prepares the MCG for FLL usage in FBE mode. With PLLS = 0, the VDIV value does not matter.
 - DIV32 (bit 4) set to 1 (if previously cleared), automatically switches RDIV bits to the proper reference divider for the FLL clock (divide-by-256)
 - c) BLPE: If transitioning through BLPE mode, clear LP (bit 3) in MCGC2 to 0 here to switch to FBE mode
 - d) FBE: Loop until PLLST (bit 5) in MCGSC is clear, indicating that the current source for the PLLS clock is the FLL
 - e) FBE: Optionally, loop until LOCK (bit 6) in the MCGSC is set, indicating that the FLL has acquired lock. Although the FLL is bypassed in FBE mode, it is still enabled and running.

3. Next, FBE mode transitions into FBI mode:
 - a) MCGC1 = 0x5C (%01011100)
 - CLKs (bits 7 and 6) in MCGSC1 set to %01 in order to switch the system clock to the internal reference clock

- IREFS (bit 2) set to 1 to select the internal reference clock as the reference clock source
 - RDIV (bits 5-3) remain unchanged because the reference divider does not affect the internal reference.
 - b) Loop until IREFST (bit 4) in MCGSC is 1, indicating the internal reference clock has been selected as the reference clock source
 - c) Loop until CLKST (bits 3 and 2) in MCGSC are %01, indicating that the internal reference clock is selected to feed MCGOUT
4. Lastly, FBI transitions into BLPI mode.
- a) MCGC2 = 0x08 (%00001000)
 - LP (bit 3) in MCGSC is 1
 - RANGE, HGO, EREFS, ERCLKEN, and EREFSTEN bits are ignored when the IREFS bit (bit2) in MCGC is set. They can remain set, or be cleared at this point.

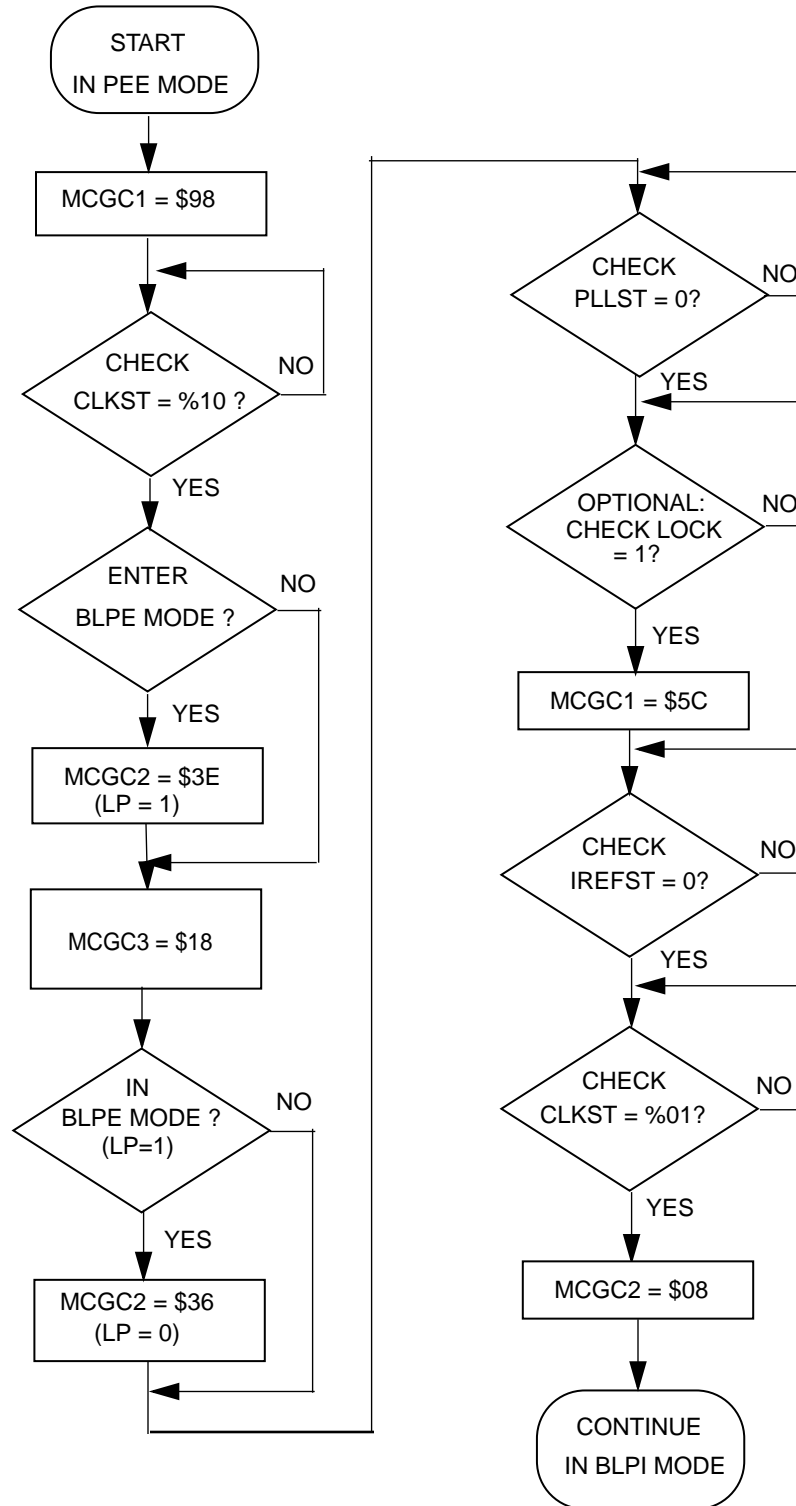

Figure 8-11. Flowchart of PEE to BLPI Mode Transition using an 8 MHz crystal

8.5.3.3 Example #3: Moving from BLPI to FEE Mode: External Crystal = 8 MHz, Bus Frequency = 16 MHz

In this example, the MCG will move through the proper operational modes from BLPI mode at a 16 kHz bus frequency running off of the internal reference clock (see previous example) to FEE mode using an 8MHz crystal configured for a 16 MHz bus frequency. First, the code sequence will be described. Then a flowchart will be included which illustrates the sequence.

1. First, BLPI must transition to FBI mode.
 - a) $MCGC2 = 0x00$ (%00000000)
 - LP (bit 3) in MCGSC is 0
 - b) Optionally, loop until LOCK (bit 6) in the MCGSC is set, indicating that the FLL has acquired lock. Although the FLL is bypassed in FBI mode, it is still enabled and running.
2. Next, FBI will transition to FEE mode.
 - a) $MCGC2 = 0x36$ (%00110110)
 - RANGE (bit 5) set to 1 because the frequency of 8 MHz is within the high frequency range
 - HGO (bit 4) set to 1 to configure external oscillator for high gain operation
 - EREFS (bit 2) set to 1, because a crystal is being used
 - ERCLKEN (bit 1) set to 1 to ensure the external reference clock is active
 - b) Loop until OSCINIT (bit 1) in MCGSC is 1, indicating the crystal selected by the EREFS bit has been initialized.
 - c) $MCGC1 = 0x18$ (%00011000)
 - CLKS (bits 7 and 6) set to %00 in order to select the output of the FLL as system clock source
 - RDIV (bits 5-3) remain at %011, or divide-by-256 for a reference of $8 \text{ MHz} / 256 = 31.25 \text{ kHz}$.
 - IREFS (bit 1) cleared to 0, selecting the external reference clock
 - d) Loop until IREFST (bit 4) in MCGSC is 0, indicating the external reference clock is the current source for the reference clock
 - e) Optionally, loop until LOCK (bit 6) in the MCGSC is set, indicating that the FLL has reacquired lock.
 - f) Loop until CLKST (bits 3 and 2) in MCGSC are %00, indicating that the output of the FLL is selected to feed MCGOUT
 - g) Now, with a 31.25 kHz reference frequency, a fixed DCO multiplier of 1024, and a bus divider of 1, $MCGOUT = 31.25 \text{ kHz} * 1024 / 1 = 32 \text{ MHz}$. Therefore, the bus frequency is 16 MHz.
 - h) At this point, by default, DRS (bit 0) in MCGT is set to 1 and DMX32 (bit 5) in MCGT is cleared to 0. If a bus frequency of 8 MHz is desired instead, clear DRS to 0 to switch the FLL multiplication factor from 1024 to 512 and loop until LOCK (bit 6) in MCGSC is set, indicating that the FLL has reacquired LOCK. To return the bus frequency to 16 MHz, set DRS to 1 again, and the FLL multiplication factor will switch back to 1024. Then loop again until the LOCK bit is set.

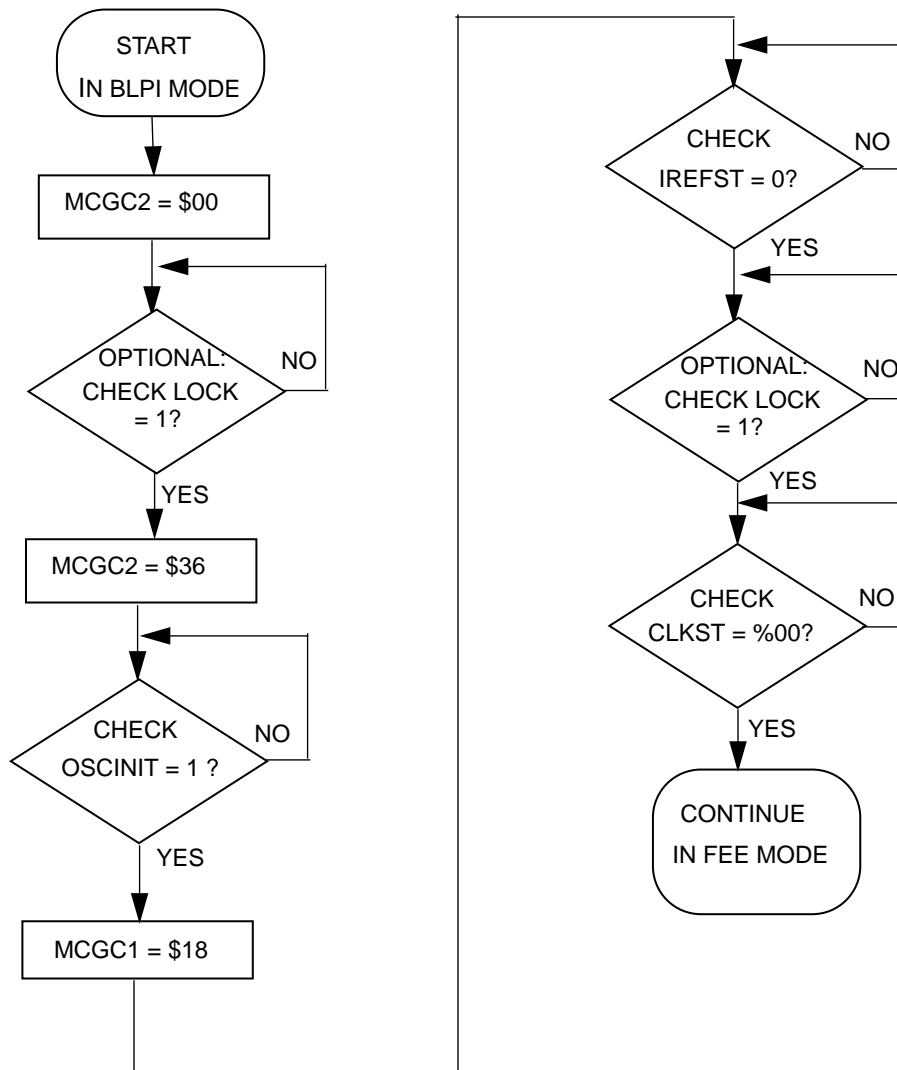

Figure 8-12. Flowchart of BLPI to FEE Mode Transition using an 8 MHz crystal

8.5.4 Calibrating the Internal Reference Clock (IRC)

The IRC is calibrated by writing to the MCGTRM register first, then using the FTRIM bit to “fine tune” the frequency. We will refer to this total 9-bit value as the trim value, ranging from 0x000 to 0x1FF, where the FTRIM bit is the LSB.

The trim value after reset is the factory trim value unless the device resets into any BDM mode in which case it is 0x800. Writing a larger value will decrease the frequency and smaller values will increase the frequency. The trim value is linear with the period, except that slight variations in wafer fab processing produce slight non-linearities between trim value and period. These non-linearities are why an iterative

trimming approach to search for the best trim value is recommended. In Example #4: Internal Reference Clock Trim later in this section, this approach will be demonstrated.

If a user specified trim value has been found for a device (to replace the factory trim value), this value can be stored in FLASH memory to save the value. If power is removed from the device, the IRC can easily be re-trimmed to the user specified value by copying the saved value from FLASH to the MCG registers. Freescale identifies recommended FLASH locations for storing the trim value for each MCU. Consult the memory map in the data sheet for these locations.

8.5.4.1 Example #4: Internal Reference Clock Trim

For applications that require a user specified tight frequency tolerance, a trimming procedure is provided that will allow a very accurate internal clock source. This section outlines one example of trimming the internal oscillator. Many other possible trimming procedures are valid and can be used.

In the example below, the MCG trim will be calibrated for the 9-bit MCGTRM and FTRIM collective value. This value will be referred to as TRMVAL.

Initial conditions:

- 1) Clock supplied from ATE has 500 μ sec duty period
- 2) MCG configured for internal reference with 8MHz bus

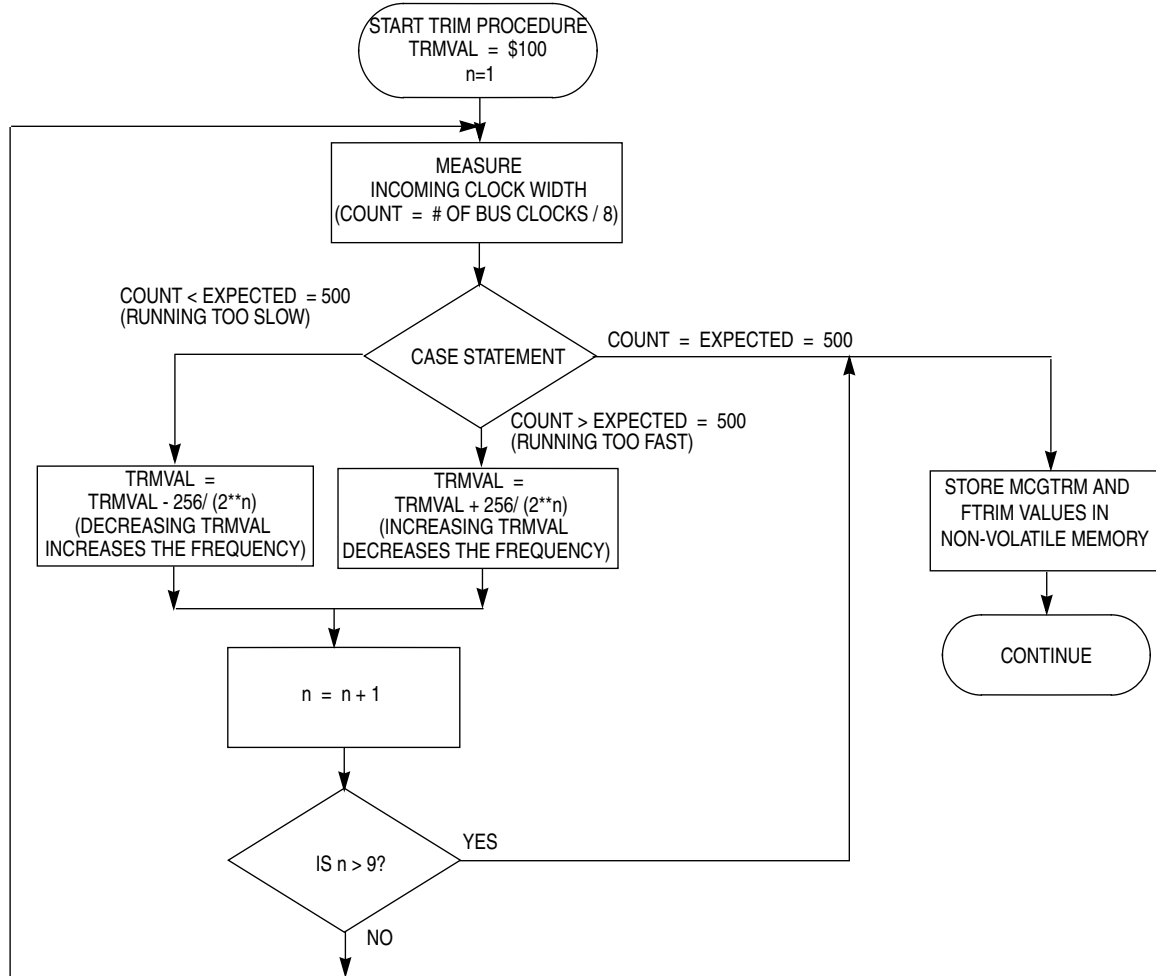

Figure 8-13. Trim Procedure

In this particular case, the MCU has been attached to a PCB and the entire assembly is undergoing final test with automated test equipment. A separate signal or message is provided to the MCU operating under user provided software control. The MCU initiates a trim procedure as outlined in Figure 8-13 while the tester supplies a precision reference signal.

If the intended bus frequency is near the maximum allowed for the device, it is recommended to trim using a reference divider value (RDIV setting) of twice the final value. After the trim procedure is complete, the reference divider can be restored. This will prevent accidental overshoot of the maximum clock frequency.

Chapter 9

5-V Analog Comparator (S08ACMPV3)

9.1 Introduction

The analog comparator module (ACMP) provides a circuit for comparing two analog input voltages or for comparing one analog input voltage to an internal reference voltage. The comparator circuit is designed to operate across the full range of the supply voltage (rail-to-rail operation).

All MC9S08DZ128 Series MCUs have two full function ACMPs. MCUs in the 48-pin package have two ACMPs, but the output of ACMP2 is not accessible.

NOTE

MC9S08DZ128 Series devices operate at a higher voltage range (2.7 V to 5.5 V) and do not include stop1 mode. Please ignore references to stop1.

ACMP2O is not available in the 48-pin package.

9.1.1 ACMP Configuration Information

When using the bandgap reference voltage for input to ACMP+, the user must enable the bandgap buffer by setting BGBE =1 in SPMSC1 see [Section 5.8.7, “System Power Management Status and Control 1 Register \(SPMSC1\).”](#) For value of bandgap voltage reference see [Appendix A, “Electrical Characteristics”](#)

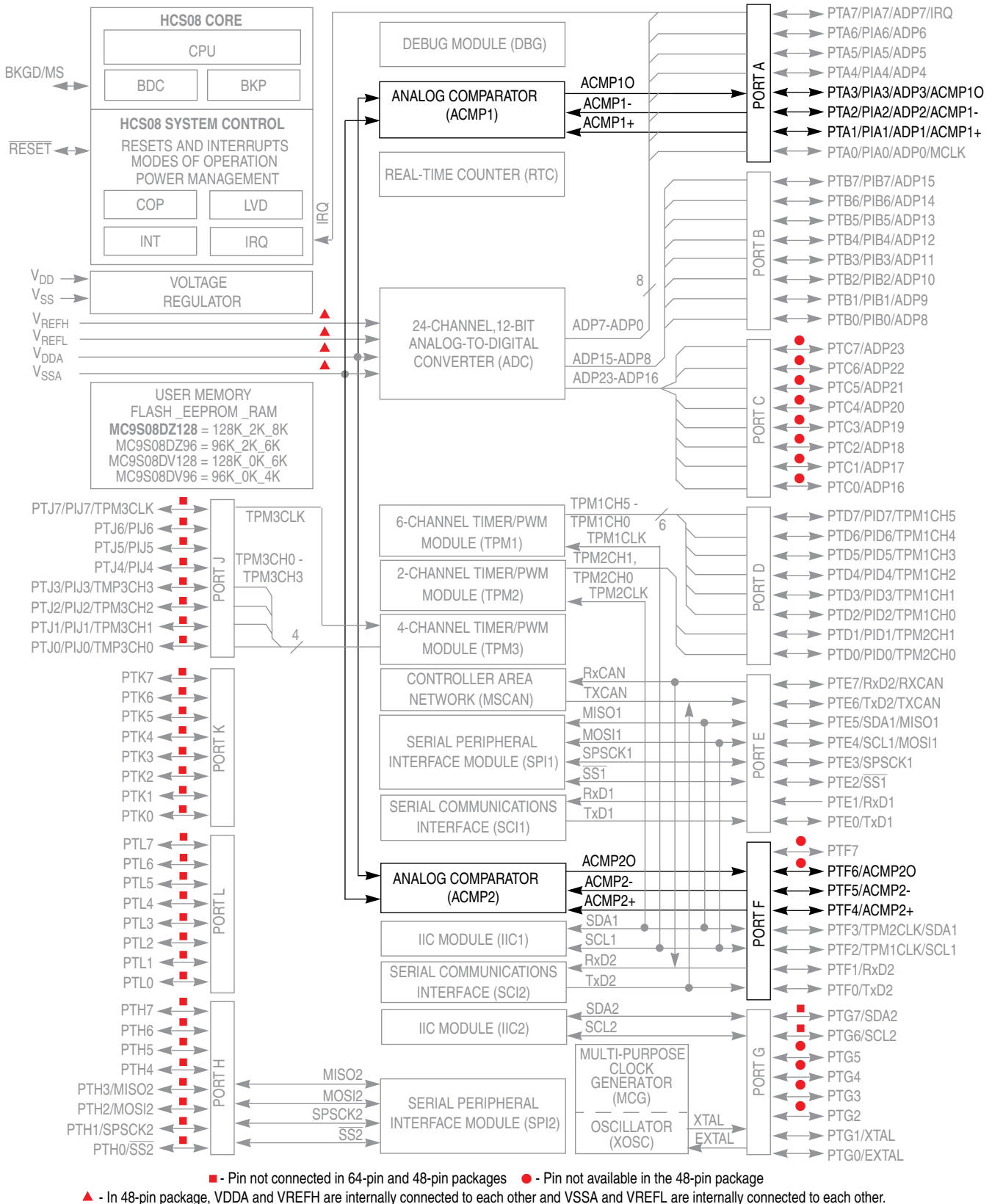

Figure 9-1. MC9S08DZ128 Block Diagram with ACMP Highlighted

9.1.2 Features

The ACMP has the following features:

- Full rail to rail supply operation.
- Selectable interrupt on rising edge, falling edge, or either rising or falling edges of comparator output.
- Option to compare to fixed internal bandgap reference voltage.
- Option to allow comparator output to be visible on a pin, ACMPxO.
- Can operate in stop3 mode

9.1.3 Modes of Operation

This section defines the ACMP operation in wait, stop and background debug modes.

9.1.3.1 ACMP in Wait Mode

The ACMP continues to run in wait mode if enabled before executing the WAIT instruction. Therefore, the ACMP can be used to bring the MCU out of wait mode if the ACMP interrupt, ACIE is enabled. For lowest possible current consumption, the ACMP should be disabled by software if not required as an interrupt source during wait mode.

9.1.3.2 ACMP in Stop Modes

9.1.3.2.1 Stop3 Mode Operation

The ACMP continues to operate in Stop3 mode if enabled and compare operation remains active. If ACOPE is enabled, comparator output operates as in the normal operating mode and comparator output is placed onto the external pin. The MCU is brought out of stop when a compare event occurs and ACIE is enabled; ACF flag sets accordingly.

If stop is exited with a reset, the ACMP will be put into its reset state.

9.1.3.2.2 Stop2 and Stop1 Mode Operation

During either Stop2 and Stop1 mode, the ACMP module will be fully powered down. Upon wake-up from Stop2 or Stop1 mode, the ACMP module will be in the reset state.

9.1.3.3 ACMP in Active Background Mode

When the microcontroller is in active background mode, the ACMP will continue to operate normally.

9.1.4 Block Diagram

The block diagram for the Analog Comparator module is shown [Figure 9-2](#).

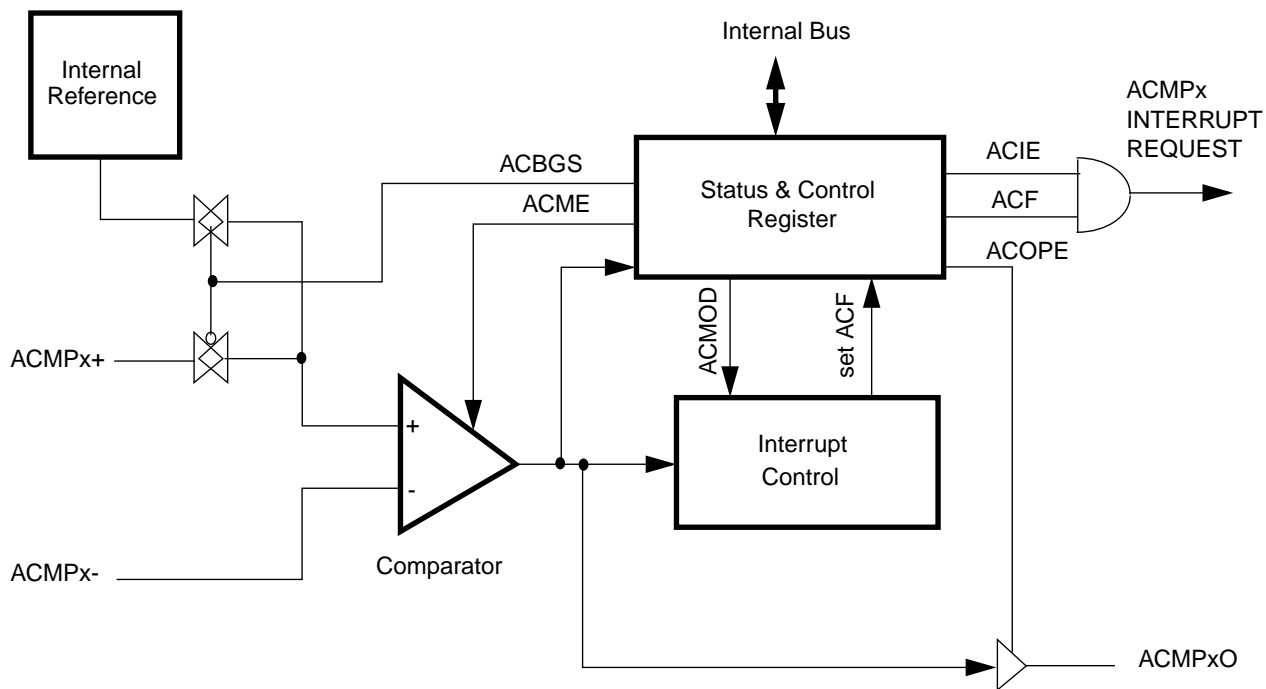

Figure 9-2. Analog Comparator 5V (ACMP5) Block Diagram

9.2 External Signal Description

The ACMP has two analog input pins, ACMPx+ and ACMPx- and one digital output pin ACMPxO. Each of these pins can accept an input voltage that varies across the full operating voltage range of the MCU. As shown in [Figure 9-2](#), the ACMPx- pin is connected to the inverting input of the comparator, and the ACMPx+ pin is connected to the comparator non-inverting input if ACBGS is a 0. As shown in [Figure 9-2](#), the ACMPxO pin can be enabled to drive an external pin.

The signal properties of ACMP are shown in [Table 9-1](#).

Table 9-1. Signal Properties

Signal	Function	I/O
ACMPx-	Inverting analog input to the ACMP. (Minus input)	I
ACMPx+	Non-inverting analog input to the ACMP. (Positive input)	I
ACMPxO	Digital output of the ACMP.	O

9.3 Memory Map

9.3.1 Register Descriptions

The ACMP includes one register:

- An 8-bit status and control register

Refer to the direct-page register summary in the memory section of this data sheet for the absolute address assignments for all ACMP registers. This section refers to registers and control bits only by their names .

Some MCUs may have more than one ACMP, so register names include placeholder characters to identify which ACMP is being referenced.

9.3.1.1 ACMPx Status and Control Register (ACMPxSC)

ACMPxSC contains the status flag and control bits which are used to enable and configure the ACMP.

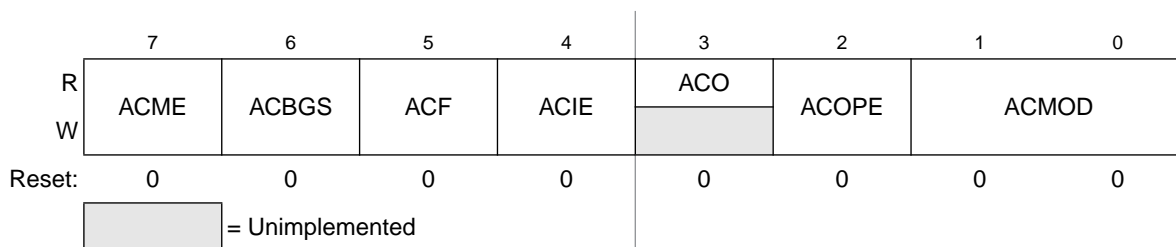

Figure 9-3. ACMPx Status and Control Register

Table 9-2. ACMPx Status and Control Register Field Descriptions

Field	Description
7 ACME	Analog Comparator Module Enable — ACME enables the ACMP module. 0 ACMP not enabled 1 ACMP is enabled
6 ACBGS	Analog Comparator Bandgap Select — ACBGS is used to select between the bandgap reference voltage or the ACMPx+ pin as the input to the non-inverting input of the analog comparator. 0 External pin ACMPx+ selected as non-inverting input to comparator 1 Internal reference select as non-inverting input to comparator Note: refer to this chapter introduction to verify if any other config bits are necessary to enable the bandgap reference in the chip level.
5 ACF	Analog Comparator Flag — ACF is set when a compare event occurs. Compare events are defined by ACMOD. ACF is cleared by writing a one to ACF. 0 Compare event has not occurred 1 Compare event has occurred
4 ACIE	Analog Comparator Interrupt Enable — ACIE enables the interrupt from the ACMP. When ACIE is set, an interrupt will be asserted when ACF is set. 0 Interrupt disabled 1 Interrupt enabled
3 ACO	Analog Comparator Output — Reading ACO will return the current value of the analog comparator output. ACO is reset to a 0 and will read as a 0 when the ACMP is disabled (ACME = 0).
2 ACOPE	Analog Comparator Output Pin Enable — ACOPE is used to enable the comparator output to be placed onto the external pin, ACMPxO. 0 Analog comparator output not available on ACMPxO 1 Analog comparator output is driven out on ACMPxO
1:0 ACMOD	Analog Comparator Mode — ACMOD selects the type of compare event which sets ACF. 00 Encoding 0 — Comparator output falling edge 01 Encoding 1 — Comparator output rising edge 10 Encoding 2 — Comparator output falling edge 11 Encoding 3 — Comparator output rising or falling edge

9.4 Functional Description

The analog comparator can be used to compare two analog input voltages applied to ACMPx+ and ACMPx-; or it can be used to compare an analog input voltage applied to ACMPx- with an internal bandgap reference voltage. ACBGS is used to select between the bandgap reference voltage or the ACMPx+ pin as the input to the non-inverting input of the analog comparator. The comparator output is high when the non-inverting input is greater than the inverting input, and is low when the non-inverting input is less than the inverting input. ACMOD is used to select the condition which will cause ACF to be set. ACF can be set on a rising edge of the comparator output, a falling edge of the comparator output, or either a rising or a falling edge (toggle). The comparator output can be read directly through ACO. The comparator output can be driven onto the ACMPxO pin using ACOPE.

Chapter 10

Analog-to-Digital Converter (S08ADC12V1)

10.1 Introduction

The 12-bit analog-to-digital converter (ADC) is a successive approximation ADC designed for operation within an integrated microcontroller system-on-chip.

NOTE

MC9S08DZ128 Series devices operate at a higher voltage range (2.7 V to 5.5 V) and do not include stop1 mode. Please ignore references to stop1.

The ADC channel assignments, alternate clock function, and hardware trigger function are configured as described in [Section 10.1.1, “Channel Assignments.”](#)

10.1.1 Channel Assignments

NOTE

The ADC channel assignments for the MC9S08DZ128 Series devices are shown in [Table 10-1](#). Reserved channels convert to an unknown value.

This chapter shows bits for all S08ADC12V1 channels. MC9S08DZ128 Series MCUs do not use all of these channels. All bits corresponding to channels that are not available on a device are reserved.

10.1.2 Analog Power and Ground Signal Names

References to V_{DDAD} and V_{SSAD} in this chapter correspond to signals V_{DDA} and V_{SSA} , respectively.

Table 10-1. ADC Channel Assignment

ADCH	Channel	Input	ADCH	Channel	Input
00000	AD0	PTA0/ADP0/MCLK	10000	AD16	PTC0/ADP16
00001	AD1	PTA1/ADP1/ACMP1+	10001	AD17	PTC1/ADP17
00010	AD2	PTA2/ADP2/ACMP1P-	10010	AD18	PTC2/ADP18
00011	AD3	PTA3/ADP3/ACMP1O	10011	AD19	PTC3/ADP19
00100	AD4	PTA4/ADP4	10100	AD20	PTC4/ADP20
00101	AD5	PTA5/ADP5	10101	AD21	PTC5/ADP21
00110	AD6	PTA6/ADP6	10110	AD22	PTC6/ADP22
00111	AD7	PTA7/ADP7	10111	AD23	PTC7/ADP23
01000	AD8	PTB0/ADP8	11000– 11001	AD24 through AD25	Reserved
01001	AD9	PTB1/ADP9	11010	AD26	Temperature Sensor ¹
01010	AD10	PTB2/ADP10	11011	AD27	Internal Bandgap ²
01011	AD11	PTB3/ADP11	11100	V _{REFH}	V _{REFH}
01100	AD12	PTB4/ADP12	11101	V _{REFH}	V _{REFH}
01101	AD13	PTB5/ADP13	11110	V _{REFL}	V _{REFL}
01110	AD14	PTB6/ADP14	11111	Module Disabled	None
01111	AD15	PTB7/ADP15			

Notes:

- 1 For information, see [Section 10.1.5, “Temperature Sensor”](#).
- 2 Requires BGBE =1 in SPMSC1 see [Section 5.8.7, “System Power Management Status and Control 1 Register \(SPMSC1\)”](#). For value of bandgap voltage reference see [Section A.6, “DC Characteristics”](#).

10.1.3 Alternate Clock

The ADC module is capable of performing conversions using the MCU bus clock, the bus clock divided by two, the local asynchronous clock (ADACK) within the module, or the alternate clock, ALTCLK. The alternate clock for the MC9S08DZ128 Series MCU devices is the external reference clock (MCGERCLK).

The selected clock source must run at a frequency such that the ADC conversion clock (ADCK) runs at a frequency within its specified range (f_{ADCK}) after being divided down from the ALTCLK input as determined by the ADIV bits.

ALTCLK is active while the MCU is in wait mode provided the conditions described above are met. This allows ALTCLK to be used as the conversion clock source for the ADC while the MCU is in wait mode.

ALTCLK cannot be used as the ADC conversion clock source while the MCU is in either stop2 or stop3.

10.1.4 Hardware Trigger

The ADC hardware trigger, ADHWT, is the output from the real time counter (RTC) overflow or the external interrupt request (IRQ) pin. The source is selected by the ADC hardware trigger select bit,

ADHTS, in the SOPT2 register. The RTC or IRQ can be configured to cause a hardware trigger in run, wait, and stop3 modes.

10.1.5 Temperature Sensor

To use the on-chip temperature sensor, the user must perform the following:

- Configure ADC for long sample with a maximum of 1 MHz clock
- Convert the bandgap voltage reference channel (AD27)
 - By converting the digital value of the bandgap voltage reference channel using the value of V_{BG} the user can determine V_{DD} . For value of bandgap voltage, see [Section A.6, “DC Characteristics”](#).
- Convert the temperature sensor channel (AD26)
 - By using the calculated value of V_{DD} , convert the digital value of AD26 into a voltage, V_{TEMP}

[Equation 10-1](#) provides an approximate transfer function of the temperature sensor.

$$\text{Temp} = 25 - ((V_{TEMP} - V_{TEMP25}) \div m) \quad \text{Eqn. 10-1}$$

where:

- V_{TEMP} is the voltage of the temperature sensor channel at the ambient temperature.
- V_{TEMP25} is the voltage of the temperature sensor channel at 25°C.
- m is the hot or cold voltage versus temperature slope in V/°C.

For temperature calculations, use the V_{TEMP25} and m values from the ADC Electricals table.

In application code, the user reads the temperature sensor channel, calculates V_{TEMP} and compares to V_{TEMP25} . If V_{TEMP} is greater than V_{TEMP25} the cold slope value is applied in [Equation 10-1](#). If V_{TEMP} is less than V_{TEMP25} the hot slope value is applied in [Equation 10-1](#).

To improve accuracy the user should calibrate the bandgap voltage reference and temperature sensor.

Calibrating at 25°C will improve accuracy to $\pm 4.5^\circ\text{C}$.

Calibration at three points, -40°C, 25°C, and 125°C will improve accuracy to $\pm 2.5^\circ\text{C}$. Once calibration has been completed, the user will need to calculate the slope for both hot and cold. In application code, the user would then calculate the temperature using [Equation 10-1](#) as detailed above and then determine if the temperature is above or below 25°C. Once determined if the temperature is above or below 25°C, the user can recalculate the temperature using the hot or cold slope value obtained during calibration.

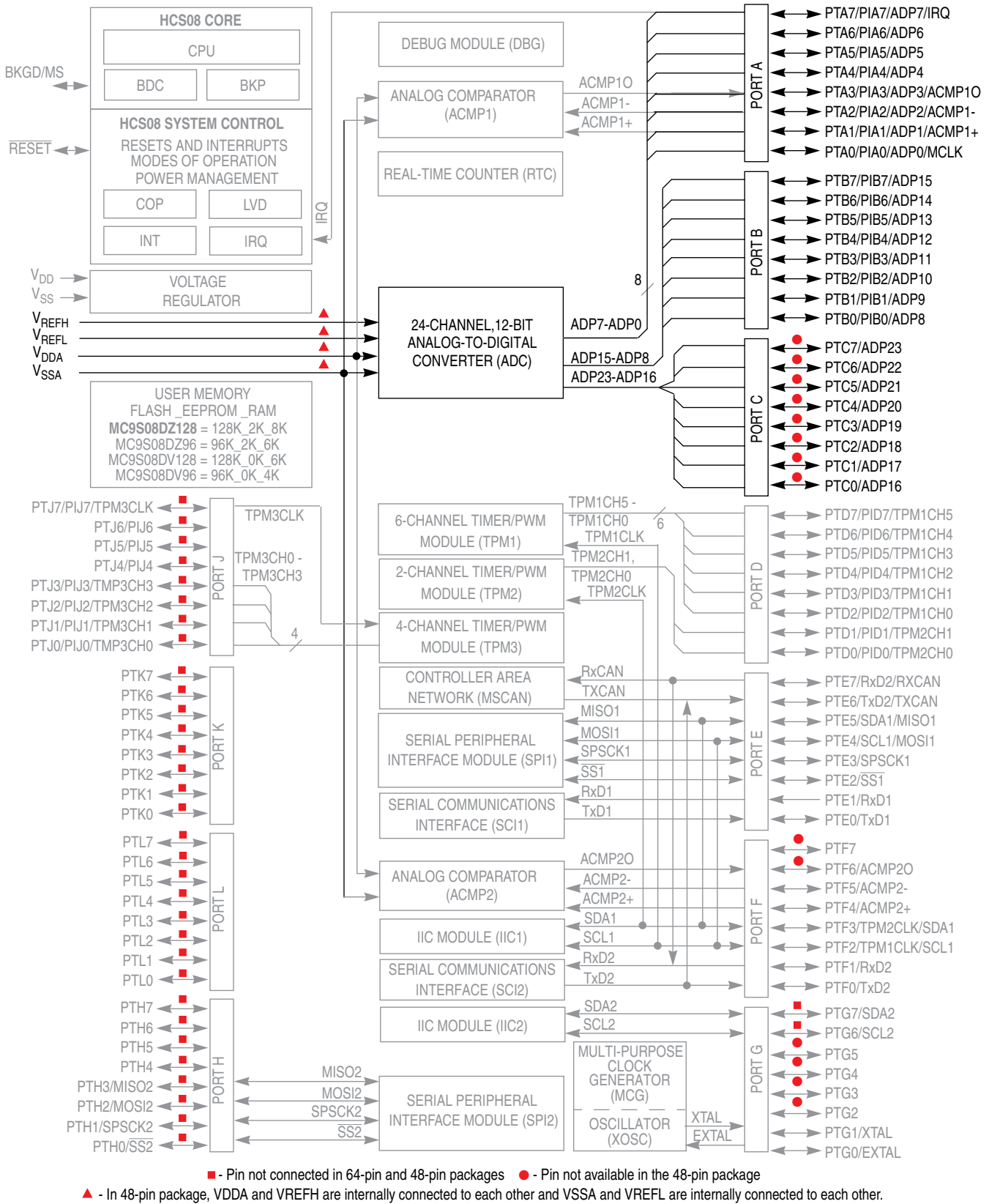

Figure 10-1. MC9S08DZ128 Block Diagram with ADC Highlighted

10.1.6 Features

Features of the ADC module include:

- Linear successive approximation algorithm with 12-bit resolution
- Up to 28 analog inputs
- Output formatted in 12-, 10-, or 8-bit right-justified unsigned format
- Single or continuous conversion (automatic return to idle after single conversion)
- Configurable sample time and conversion speed/power
- Conversion complete flag and interrupt
- Input clock selectable from up to four sources
- Operation in wait or stop3 modes for lower noise operation
- Asynchronous clock source for lower noise operation
- Selectable asynchronous hardware conversion trigger
- Automatic compare with interrupt for less-than, or greater-than or equal-to, programmable value
- Temperature sensor

10.1.7 ADC Module Block Diagram

Figure 10-2 provides a block diagram of the ADC module.

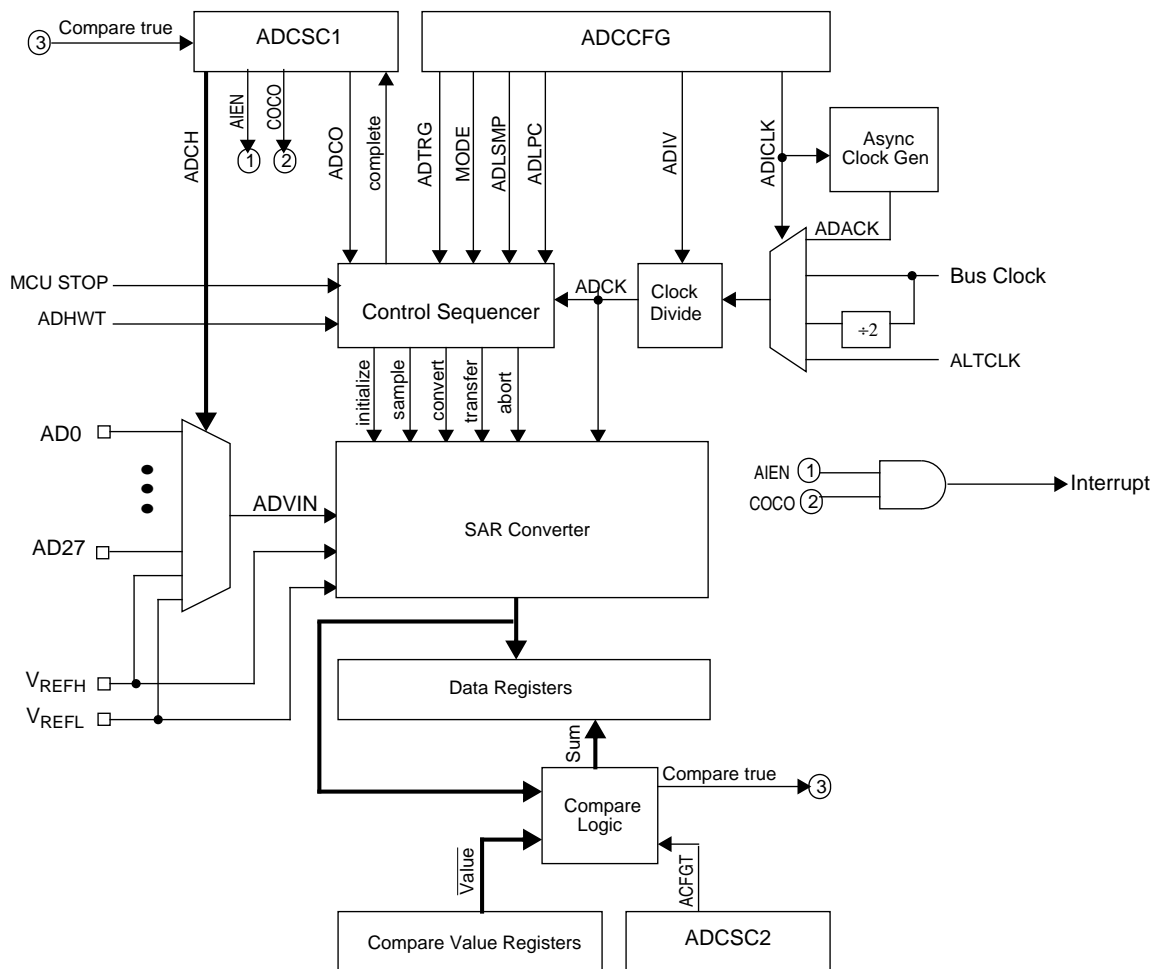

Figure 10-2. ADC Block Diagram

10.2 External Signal Description

The ADC module supports up to 28 separate analog inputs. It also requires four supply/reference/ground connections.

Table 10-2. Signal Properties

Name	Function
AD27–AD0	Analog Channel inputs
V _{REFH}	High reference voltage
V _{REFL}	Low reference voltage
V _{DDAD}	Analog power supply
V _{SSAD}	Analog ground

10.2.1 Analog Power (V_{DDAD})

The ADC analog portion uses V_{DDAD} as its power connection. In some packages, V_{DDAD} is connected internally to V_{DD} . If externally available, connect the V_{DDAD} pin to the same voltage potential as V_{DD} . External filtering may be necessary to ensure clean V_{DDAD} for good results.

10.2.2 Analog Ground (V_{SSAD})

The ADC analog portion uses V_{SSAD} as its ground connection. In some packages, V_{SSAD} is connected internally to V_{SS} . If externally available, connect the V_{SSAD} pin to the same voltage potential as V_{SS} .

10.2.3 Voltage Reference High (V_{REFH})

V_{REFH} is the high reference voltage for the converter. In some packages, V_{REFH} is connected internally to V_{DDAD} . If externally available, V_{REFH} may be connected to the same potential as V_{DDAD} or may be driven by an external source between the minimum V_{DDAD} spec and the V_{DDAD} potential (V_{REFH} must never exceed V_{DDAD}).

10.2.4 Voltage Reference Low (V_{REFL})

V_{REFL} is the low-reference voltage for the converter. In some packages, V_{REFL} is connected internally to V_{SSAD} . If externally available, connect the V_{REFL} pin to the same voltage potential as V_{SSAD} .

10.2.5 Analog Channel Inputs (ADx)

The ADC module supports up to 28 separate analog inputs. An input is selected for conversion through the ADCH channel select bits.

10.3 Register Definition

These memory-mapped registers control and monitor operation of the ADC:

- Status and control register, ADCSC1
- Status and control register, ADCSC2
- Data result registers, ADCRH and ADCRL
- Compare value registers, ADCCVH and ADCCVL
- Configuration register, ADCCFG
- Pin control registers, APCTL1, APCTL2, APCTL3

10.3.1 Status and Control Register 1 (ADCSC1)

This section describes the function of the ADC status and control register (ADCSC1). Writing ADCSC1 aborts the current conversion and initiates a new conversion (if the ADCH bits are equal to a value other than all 1s).

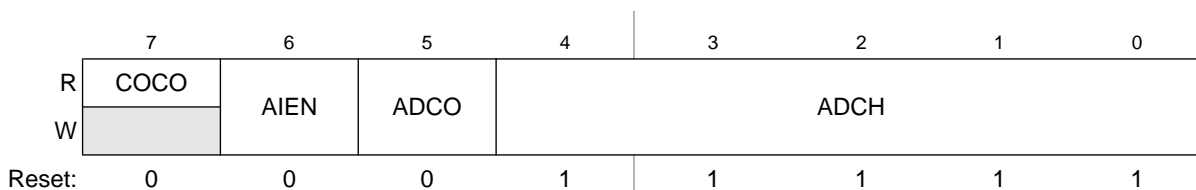
Figure 10-3. Status and Control Register (ADCSC1)
Table 10-3. ADCSC1 Field Descriptions

Field	Description
7 COCO	Conversion Complete Flag. The COCO flag is a read-only bit set each time a conversion is completed when the compare function is disabled (ACFE = 0). When the compare function is enabled (ACFE = 1), the COCO flag is set upon completion of a conversion only if the compare result is true. This bit is cleared when ADCSC1 is written or when ADCRL is read. 0 Conversion not completed 1 Conversion completed
6 AIEN	Interrupt Enable AIEN enables conversion complete interrupts. When COCO becomes set while AIEN is high, an interrupt is asserted. 0 Conversion complete interrupt disabled 1 Conversion complete interrupt enabled
5 ADCO	Continuous Conversion Enable. ADCO enables continuous conversions. 0 One conversion following a write to the ADCSC1 when software triggered operation is selected, or one conversion following assertion of ADHWT when hardware triggered operation is selected. 1 Continuous conversions initiated following a write to ADCSC1 when software triggered operation is selected. Continuous conversions are initiated by an ADHWT event when hardware triggered operation is selected.
4:0 ADCH	Input Channel Select. The ADCH bits form a 5-bit field that selects one of the input channels. The input channels are detailed in Table 10-4 . The successive approximation converter subsystem is turned off when the channel select bits are all set. This feature allows for explicit disabling of the ADC and isolation of the input channel from all sources. Terminating continuous conversions this way prevents an additional, single conversion from being performed. It is not necessary to set the channel select bits to all ones to place the ADC in a low-power state when continuous conversions are not enabled because the module automatically enters a low-power state when a conversion completes.

Table 10-4. Input Channel Select

ADCH	Input Select
00000–01111	AD0–15
10000–11011	AD16–27
11100	Reserved
11101	V _{REFH}
11110	V _{REFL}
11111	Module disabled

10.3.2 Status and Control Register 2 (ADCSC2)

The ADCSC2 register controls the compare function, conversion trigger, and conversion active of the ADC module.

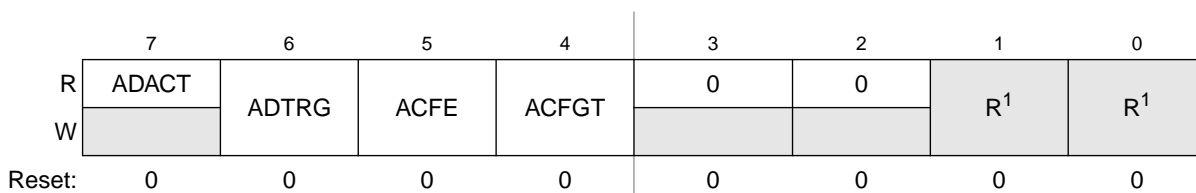

Figure 10-4. Status and Control Register 2 (ADCSC2)

¹ Bits 1 and 0 are reserved bits that must always be written to 0.

Table 10-5. ADCSC2 Register Field Descriptions

Field	Description
7 ADACT	Conversion Active. Indicates that a conversion is in progress. ADACT is set when a conversion is initiated and cleared when a conversion is completed or aborted. 0 Conversion not in progress 1 Conversion in progress
6 ADTRG	Conversion Trigger Select. Selects the type of trigger used for initiating a conversion. Two types of triggers are selectable: software trigger and hardware trigger. When software trigger is selected, a conversion is initiated following a write to ADCSC1. When hardware trigger is selected, a conversion is initiated following the assertion of the ADHWT input. 0 Software trigger selected 1 Hardware trigger selected
5 ACFE	Compare Function Enable. Enables the compare function. 0 Compare function disabled 1 Compare function enabled
4 ACFGT	Compare Function Greater Than Enable. Configures the compare function to trigger when the result of the conversion of the input being monitored is greater than or equal to the compare value. The compare function defaults to triggering when the result of the compare of the input being monitored is less than the compare value. 0 Compare triggers when input is less than compare value 1 Compare triggers when input is greater than or equal to compare value

10.3.3 Data Result High Register (ADCRH)

In 12-bit operation, ADCRH contains the upper four bits of the result of a 12-bit conversion. In 10-bit mode, ADCRH contains the upper two bits of the result of a 10-bit conversion. When configured for 10-bit mode, ADR[11:10] are cleared. When configured for 8-bit mode, ADR[11:8] are cleared.

In 12-bit and 10-bit mode, ADCRH is updated each time a conversion completes except when automatic compare is enabled and the compare condition is not met. When a compare event does occur, the value is the addition of the conversion result and the two's complement of the compare value. In 12-bit and 10-bit mode, reading ADCRH prevents the ADC from transferring subsequent conversion results into the result registers until ADCRL is read. If ADCRL is not read until after the next conversion is completed, the intermediate conversion result is lost. In 8-bit mode, there is no interlocking with ADCRL.

If the MODE bits are changed, any data in ADCRH becomes invalid.

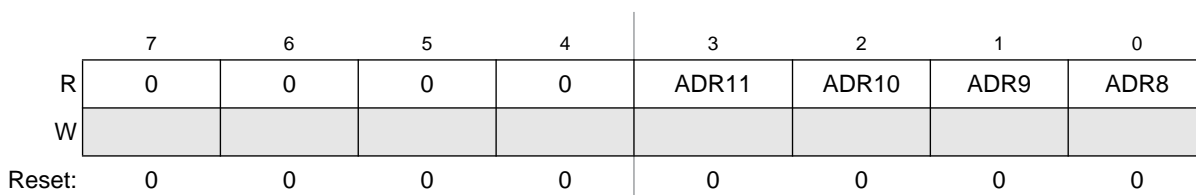

Figure 10-5. Data Result High Register (ADCRH)

10.3.4 Data Result Low Register (ADCRL)

ADCRL contains the lower eight bits of the result of a 12-bit or 10-bit conversion, and all eight bits of an 8-bit conversion. This register is updated each time a conversion completes except when automatic compare is enabled and the compare condition is not met. In 12-bit and 10-bit mode, reading ADCRH prevents the ADC from transferring subsequent conversion results into the result registers until ADCRL is read. If ADCRL is not read until the after next conversion is completed, the intermediate conversion results are lost. In 8-bit mode, there is no interlocking with ADCRH. If the MODE bits are changed, any data in ADCRL becomes invalid.

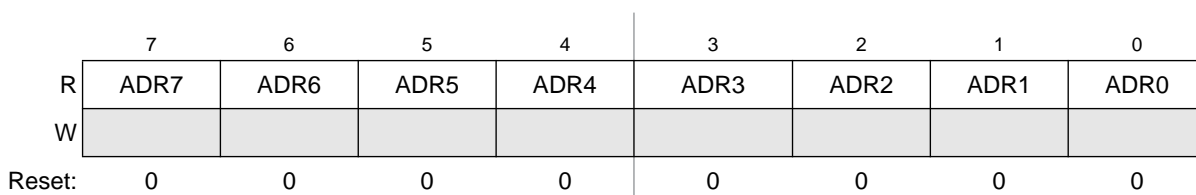

Figure 10-6. Data Result Low Register (ADCRL)

10.3.5 Compare Value High Register (ADCCVH)

In 12-bit mode, the ADCCVH register holds the upper four bits of the 12-bit compare value. When the compare function is enabled, these bits are compared to the upper four bits of the result following a conversion in 12-bit mode.

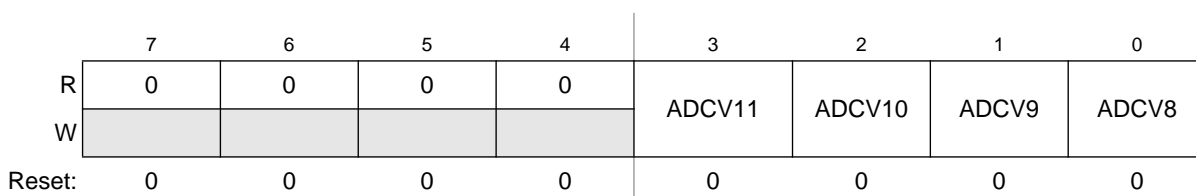

Figure 10-7. Compare Value High Register (ADCCVH)

In 10-bit mode, the ADCCVH register holds the upper two bits of the 10-bit compare value (ADCV[9:8]). These bits are compared to the upper two bits of the result following a conversion in 10-bit mode when the compare function is enabled.

In 8-bit mode, ADCCVH is not used during compare.

10.3.6 Compare Value Low Register (ADCCVL)

This register holds the lower 8 bits of the 12-bit or 10-bit compare value or all 8 bits of the 8-bit compare value. When the compare function is enabled, bits ADCV[7:0] are compared to the lower 8 bits of the result following a conversion in 12-bit, 10-bit or 8-bit mode.

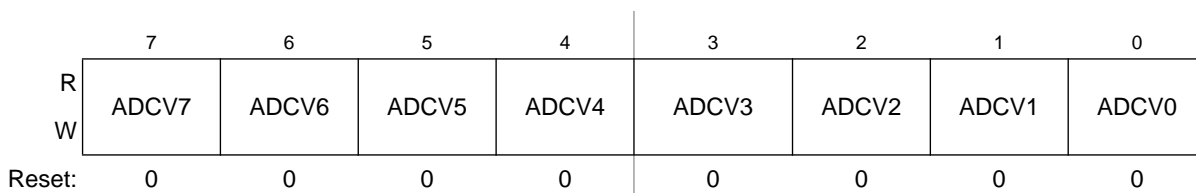

Figure 10-8. Compare Value Low Register(ADCCVL)

10.3.7 Configuration Register (ADCCFG)

ADCCFG selects the mode of operation, clock source, clock divide, and configures for low power and long sample time.

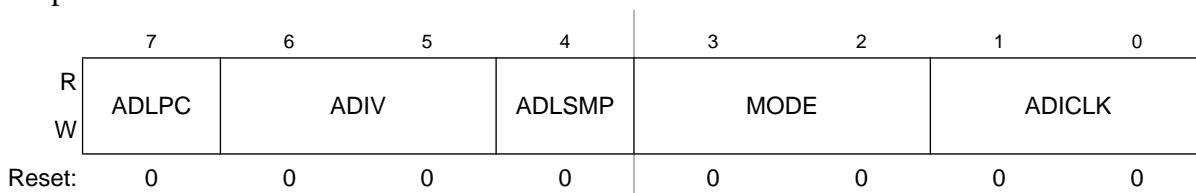

Figure 10-9. Configuration Register (ADCCFG)

Table 10-6. ADCCFG Register Field Descriptions

Field	Description
7 ADLPC	Low-Power Configuration. ADLPC controls the speed and power configuration of the successive approximation converter. This optimizes power consumption when higher sample rates are not required. 0 High speed configuration 1 Low power configuration:The power is reduced at the expense of maximum clock speed.
6:5 ADIV	Clock Divide Select. ADIV selects the divide ratio used by the ADC to generate the internal clock ADCK. Table 10-7 shows the available clock configurations.
4 ADLSMP	Long Sample Time Configuration. ADLSMP selects between long and short sample time. This adjusts the sample period to allow higher impedance inputs to be accurately sampled or to maximize conversion speed for lower impedance inputs. Longer sample times can also be used to lower overall power consumption when continuous conversions are enabled if high conversion rates are not required. 0 Short sample time 1 Long sample time

Table 10-6. ADCCFG Register Field Descriptions (continued)

Field	Description
3:2 MODE	Conversion Mode Selection. MODE bits are used to select between 12-, 10-, or 8-bit operation. See Table 10-8 .
1:0 ADICLK	Input Clock Select. ADICLK bits select the input clock source to generate the internal clock ADCK. See Table 10-9 .

Table 10-7. Clock Divide Select

ADIV	Divide Ratio	Clock Rate
00	1	Input clock
01	2	Input clock ÷ 2
10	4	Input clock ÷ 4
11	8	Input clock ÷ 8

Table 10-8. Conversion Modes

MODE	Mode Description
00	8-bit conversion (N=8)
01	12-bit conversion (N=12)
10	10-bit conversion (N=10)
11	Reserved

Table 10-9. Input Clock Select

ADICLK	Selected Clock Source
00	Bus clock
01	Bus clock divided by 2
10	Alternate clock (ALTCLK)
11	Asynchronous clock (ADACK)

10.3.8 Pin Control 1 Register (APCTL1)

The pin control registers disable the I/O port control of MCU pins used as analog inputs. APCTL1 is

used to control the pins associated with channels 0–7 of the ADC module.

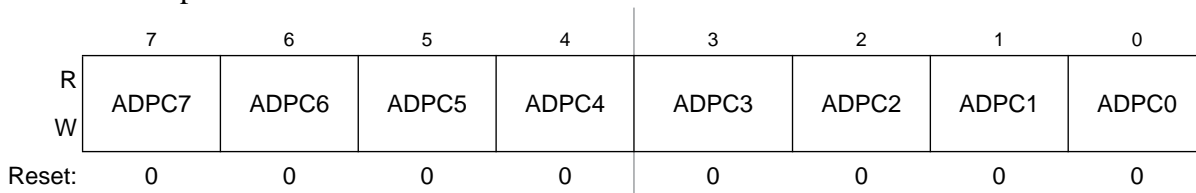

Figure 10-10. Pin Control 1 Register (APCTL1)

Table 10-10. APCTL1 Register Field Descriptions

Field	Description
7 ADPC7	ADC Pin Control 7. ADPC7 controls the pin associated with channel AD7. 0 AD7 pin I/O control enabled 1 AD7 pin I/O control disabled
6 ADPC6	ADC Pin Control 6. ADPC6 controls the pin associated with channel AD6. 0 AD6 pin I/O control enabled 1 AD6 pin I/O control disabled
5 ADPC5	ADC Pin Control 5. ADPC5 controls the pin associated with channel AD5. 0 AD5 pin I/O control enabled 1 AD5 pin I/O control disabled
4 ADPC4	ADC Pin Control 4. ADPC4 controls the pin associated with channel AD4. 0 AD4 pin I/O control enabled 1 AD4 pin I/O control disabled
3 ADPC3	ADC Pin Control 3. ADPC3 controls the pin associated with channel AD3. 0 AD3 pin I/O control enabled 1 AD3 pin I/O control disabled
2 ADPC2	ADC Pin Control 2. ADPC2 controls the pin associated with channel AD2. 0 AD2 pin I/O control enabled 1 AD2 pin I/O control disabled
1 ADPC1	ADC Pin Control 1. ADPC1 controls the pin associated with channel AD1. 0 AD1 pin I/O control enabled 1 AD1 pin I/O control disabled
0 ADPC0	ADC Pin Control 0. ADPC0 controls the pin associated with channel AD0. 0 AD0 pin I/O control enabled 1 AD0 pin I/O control disabled

10.3.9 Pin Control 2 Register (APCTL2)

APCTL2 controls channels 8–15 of the ADC module.

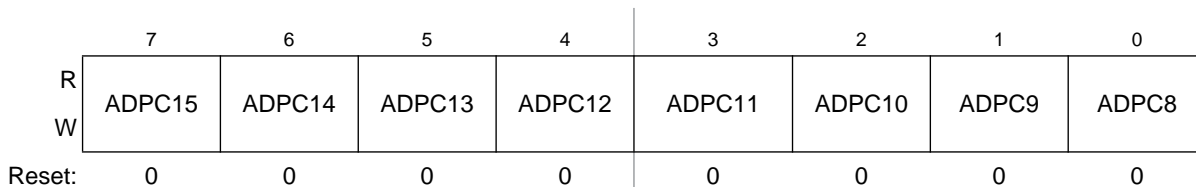

Figure 10-11. Pin Control 2 Register (APCTL2)

Table 10-11. APCTL2 Register Field Descriptions

Field	Description
7 ADPC15	ADC Pin Control 15. ADPC15 controls the pin associated with channel AD15. 0 AD15 pin I/O control enabled 1 AD15 pin I/O control disabled
6 ADPC14	ADC Pin Control 14. ADPC14 controls the pin associated with channel AD14. 0 AD14 pin I/O control enabled 1 AD14 pin I/O control disabled
5 ADPC13	ADC Pin Control 13. ADPC13 controls the pin associated with channel AD13. 0 AD13 pin I/O control enabled 1 AD13 pin I/O control disabled
4 ADPC12	ADC Pin Control 12. ADPC12 controls the pin associated with channel AD12. 0 AD12 pin I/O control enabled 1 AD12 pin I/O control disabled
3 ADPC11	ADC Pin Control 11. ADPC11 controls the pin associated with channel AD11. 0 AD11 pin I/O control enabled 1 AD11 pin I/O control disabled
2 ADPC10	ADC Pin Control 10. ADPC10 controls the pin associated with channel AD10. 0 AD10 pin I/O control enabled 1 AD10 pin I/O control disabled
1 ADPC9	ADC Pin Control 9. ADPC9 controls the pin associated with channel AD9. 0 AD9 pin I/O control enabled 1 AD9 pin I/O control disabled
0 ADPC8	ADC Pin Control 8. ADPC8 controls the pin associated with channel AD8. 0 AD8 pin I/O control enabled 1 AD8 pin I/O control disabled

10.3.10 Pin Control 3 Register (APCTL3)

APCTL3 controls channels 16–23 of the ADC module.

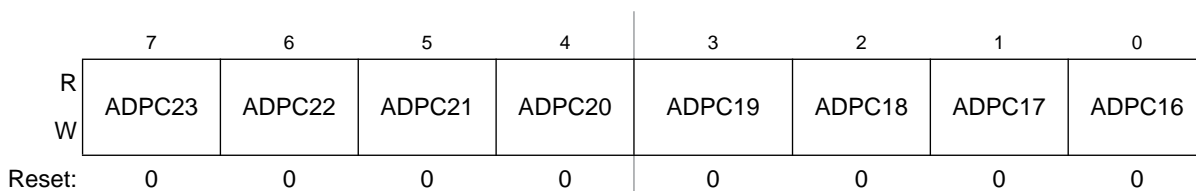

Figure 10-12. Pin Control 3 Register (APCTL3)

Table 10-12. APCTL3 Register Field Descriptions

Field	Description
7 ADPC23	ADC Pin Control 23. ADPC23 controls the pin associated with channel AD23. 0 AD23 pin I/O control enabled 1 AD23 pin I/O control disabled
6 ADPC22	ADC Pin Control 22. ADPC22 controls the pin associated with channel AD22. 0 AD22 pin I/O control enabled 1 AD22 pin I/O control disabled
5 ADPC21	ADC Pin Control 21. ADPC21 controls the pin associated with channel AD21. 0 AD21 pin I/O control enabled 1 AD21 pin I/O control disabled
4 ADPC20	ADC Pin Control 20. ADPC20 controls the pin associated with channel AD20. 0 AD20 pin I/O control enabled 1 AD20 pin I/O control disabled
3 ADPC19	ADC Pin Control 19. ADPC19 controls the pin associated with channel AD19. 0 AD19 pin I/O control enabled 1 AD19 pin I/O control disabled
2 ADPC18	ADC Pin Control 18. ADPC18 controls the pin associated with channel AD18. 0 AD18 pin I/O control enabled 1 AD18 pin I/O control disabled
1 ADPC17	ADC Pin Control 17. ADPC17 controls the pin associated with channel AD17. 0 AD17 pin I/O control enabled 1 AD17 pin I/O control disabled
0 ADPC16	ADC Pin Control 16. ADPC16 controls the pin associated with channel AD16. 0 AD16 pin I/O control enabled 1 AD16 pin I/O control disabled

10.4 Functional Description

The ADC module is disabled during reset or when the ADCH bits are all high. The module is idle when a conversion has completed and another conversion has not been initiated. When idle, the module is in its lowest power state.

The ADC can perform an analog-to-digital conversion on any of the software selectable channels. In 12-bit and 10-bit mode, the selected channel voltage is converted by a successive approximation algorithm into a 12-bit digital result. In 8-bit mode, the selected channel voltage is converted by a successive approximation algorithm into a 9-bit digital result.

When the conversion is completed, the result is placed in the data registers (ADCRH and ADCRL). In 10-bit mode, the result is rounded to 10 bits and placed in the data registers (ADCRH and ADCRL). In 8-bit mode, the result is rounded to 8 bits and placed in ADCRL. The conversion complete flag (COCO) is then set and an interrupt is generated if the conversion complete interrupt has been enabled (AIEN = 1).

The ADC module has the capability of automatically comparing the result of a conversion with the contents of its compare registers. The compare function is enabled by setting the ACFE bit and operates with any of the conversion modes and configurations.

10.4.1 Clock Select and Divide Control

One of four clock sources can be selected as the clock source for the ADC module. This clock source is then divided by a configurable value to generate the input clock to the converter (ADCK). The clock is selected from one of the following sources by means of the ADICLK bits.

- The bus clock, which is equal to the frequency at which software is executed. This is the default selection following reset.
- The bus clock divided by two. For higher bus clock rates, this allows a maximum divide by 16 of the bus clock.
- ALTCLK, as defined for this MCU (See module section introduction).
- The asynchronous clock (ADACK). This clock is generated from a clock source within the ADC module. When selected as the clock source, this clock remains active while the MCU is in wait or stop3 mode and allows conversions in these modes for lower noise operation.

Whichever clock is selected, its frequency must fall within the specified frequency range for ADCK. If the available clocks are too slow, the ADC do not perform according to specifications. If the available clocks are too fast, the clock must be divided to the appropriate frequency. This divider is specified by the ADIV bits and can be divide-by 1, 2, 4, or 8.

10.4.2 Input Select and Pin Control

The pin control registers (APCTL3, APCTL2, and APCTL1) disable the I/O port control of the pins used as analog inputs. When a pin control register bit is set, the following conditions are forced for the associated MCU pin:

- The output buffer is forced to its high impedance state.
- The input buffer is disabled. A read of the I/O port returns a zero for any pin with its input buffer disabled.
- The pullup is disabled.

10.4.3 Hardware Trigger

The ADC module has a selectable asynchronous hardware conversion trigger, ADHWT, that is enabled when the ADTRG bit is set. This source is not available on all MCUs. Consult the module introduction for information on the ADHWT source specific to this MCU.

When ADHWT source is available and hardware trigger is enabled (ADTRG=1), a conversion is initiated on the rising edge of ADHWT. If a conversion is in progress when a rising edge occurs, the rising edge is ignored. In continuous convert configuration, only the initial rising edge to launch continuous conversions is observed. The hardware trigger function operates in conjunction with any of the conversion modes and configurations.

10.4.4 Conversion Control

Conversions can be performed in 12-bit mode, 10-bit mode, or 8-bit mode as determined by the MODE bits. Conversions can be initiated by a software or hardware trigger. In addition, the ADC module can be

configured for low power operation, long sample time, continuous conversion, and automatic compare of the conversion result to a software determined compare value.

10.4.4.1 Initiating Conversions

A conversion is initiated:

- Following a write to ADCSC1 (with ADCH bits not all 1s) if software triggered operation is selected.
- Following a hardware trigger (ADHWT) event if hardware triggered operation is selected.
- Following the transfer of the result to the data registers when continuous conversion is enabled.

If continuous conversions are enabled, a new conversion is automatically initiated after the completion of the current conversion. In software triggered operation, continuous conversions begin after ADCSC1 is written and continue until aborted. In hardware triggered operation, continuous conversions begin after a hardware trigger event and continue until aborted.

10.4.4.2 Completing Conversions

A conversion is completed when the result of the conversion is transferred into the data result registers, ADCRH and ADCRL. This is indicated by the setting of COCO. An interrupt is generated if AIEN is high at the time that COCO is set.

A blocking mechanism prevents a new result from overwriting previous data in ADCRH and ADCRL if the previous data is in the process of being read while in 12-bit or 10-bit MODE (the ADCRH register has been read but the ADCRL register has not). When blocking is active, the data transfer is blocked, COCO is not set, and the new result is lost. In the case of single conversions with the compare function enabled and the compare condition false, blocking has no effect and ADC operation is terminated. In all other cases of operation, when a data transfer is blocked, another conversion is initiated regardless of the state of ADCO (single or continuous conversions enabled).

If single conversions are enabled, the blocking mechanism could result in several discarded conversions and excess power consumption. To avoid this issue, the data registers must not be read after initiating a single conversion until the conversion completes.

10.4.4.3 Aborting Conversions

Any conversion in progress is aborted when:

- A write to ADCSC1 occurs (the current conversion will be aborted and a new conversion will be initiated, if ADCH are not all 1s).
- A write to ADCSC2, ADCCFG, ADCCVH, or ADCCVL occurs. This indicates a mode of operation change has occurred and the current conversion is therefore invalid.
- The MCU is reset.
- The MCU enters stop mode with ADACK not enabled.

When a conversion is aborted, the contents of the data registers, ADCRH and ADCRL, are not altered. However, they continue to be the values transferred after the completion of the last successful conversion. If the conversion was aborted by a reset, ADCRH and ADCRL return to their reset states.

10.4.4.4 Power Control

The ADC module remains in its idle state until a conversion is initiated. If ADACK is selected as the conversion clock source, the ADACK clock generator is also enabled.

Power consumption when active can be reduced by setting ADLPC. This results in a lower maximum value for f_{ADCK} (see the electrical specifications).

10.4.4.5 Sample Time and Total Conversion Time

The total conversion time depends on the sample time (as determined by ADLSMP), the MCU bus frequency, the conversion mode (8-bit, 10-bit or 12-bit), and the frequency of the conversion clock (f_{ADCK}). After the module becomes active, sampling of the input begins. ADLSMP selects between short (3.5 ADCK cycles) and long (23.5 ADCK cycles) sample times. When sampling is complete, the converter is isolated from the input channel and a successive approximation algorithm is performed to determine the digital value of the analog signal. The result of the conversion is transferred to ADCRH and ADCRL upon completion of the conversion algorithm.

If the bus frequency is less than the f_{ADCK} frequency, precise sample time for continuous conversions cannot be guaranteed when short sample is enabled (ADLSMP=0). If the bus frequency is less than 1/11th of the f_{ADCK} frequency, precise sample time for continuous conversions cannot be guaranteed when long sample is enabled (ADLSMP=1).

The maximum total conversion time for different conditions is summarized in [Table 10-13](#).

Table 10-13. Total Conversion Time vs. Control Conditions

Conversion Type	ADICLK	ADLSMP	Max Total Conversion Time
Single or first continuous 8-bit	0x, 10	0	20 ADCK cycles + 5 bus clock cycles
Single or first continuous 10-bit or 12-bit	0x, 10	0	23 ADCK cycles + 5 bus clock cycles
Single or first continuous 8-bit	0x, 10	1	40 ADCK cycles + 5 bus clock cycles
Single or first continuous 10-bit or 12-bit	0x, 10	1	43 ADCK cycles + 5 bus clock cycles
Single or first continuous 8-bit	11	0	5 μ s + 20 ADCK + 5 bus clock cycles
Single or first continuous 10-bit or 12-bit	11	0	5 μ s + 23 ADCK + 5 bus clock cycles
Single or first continuous 8-bit	11	1	5 μ s + 40 ADCK + 5 bus clock cycles
Single or first continuous 10-bit or 12-bit	11	1	5 μ s + 43 ADCK + 5 bus clock cycles
Subsequent continuous 8-bit; $f_{BUS} \geq f_{ADCK}$	xx	0	17 ADCK cycles
Subsequent continuous 10-bit or 12-bit; $f_{BUS} \geq f_{ADCK}$	xx	0	20 ADCK cycles
Subsequent continuous 8-bit; $f_{BUS} \geq f_{ADCK}/11$	xx	1	37 ADCK cycles

Table 10-13. Total Conversion Time vs. Control Conditions

Conversion Type	ADICLK	ADLSMP	Max Total Conversion Time
Subsequent continuous 10-bit or 12-bit; $f_{\text{BUS}} \geq f_{\text{ADCK}}/11$	xx	1	40 ADCK cycles

The maximum total conversion time is determined by the clock source chosen and the divide ratio selected. The clock source is selectable by the ADICLK bits, and the divide ratio is specified by the ADIV bits. For example, in 10-bit mode, with the bus clock selected as the input clock source, the input clock divide-by-1 ratio selected, and a bus frequency of 8 MHz, then the conversion time for a single conversion is:

$$\text{Conversion time} = \frac{23 \text{ ADCK Cyc}}{8 \text{ MHz}/1} + \frac{5 \text{ bus Cyc}}{8 \text{ MHz}} = 3.5 \text{ ms}$$

$$\text{Number of bus cycles} = 3.5 \text{ ms} \times 8 \text{ MHz} = 28 \text{ cycles}$$

NOTE

The ADCK frequency must be between f_{ADCK} minimum and f_{ADCK} maximum to meet ADC specifications.

10.4.5 Automatic Compare Function

The compare function can be configured to check for an upper or lower limit. After the input is sampled and converted, the result is added to the two's complement of the compare value (ADCCVH and ADCCVL). When comparing to an upper limit (ACFGT = 1), if the result is greater-than or equal-to the compare value, COCO is set. When comparing to a lower limit (ACFGT = 0), if the result is less than the compare value, COCO is set. The value generated by the addition of the conversion result and the two's complement of the compare value is transferred to ADCRH and ADCRL.

Upon completion of a conversion while the compare function is enabled, if the compare condition is not true, COCO is not set and no data is transferred to the result registers. An ADC interrupt is generated upon the setting of COCO if the ADC interrupt is enabled (AIEN = 1).

NOTE

The compare function can monitor the voltage on a channel while the MCU is in wait or stop3 mode. The ADC interrupt wakes the MCU when the compare condition is met.

10.4.6 MCU Wait Mode Operation

Wait mode is a lower power-consumption standby mode from which recovery is fast because the clock sources remain active. If a conversion is in progress when the MCU enters wait mode, it continues until completion. Conversions can be initiated while the MCU is in wait mode by means of the hardware trigger or if continuous conversions are enabled.

The bus clock, bus clock divided by two, and ADACK are available as conversion clock sources while in wait mode. The use of ALTCLK as the conversion clock source in wait is dependent on the definition of

ALTCLK for this MCU. Consult the module introduction for information on ALTCLK specific to this MCU.

A conversion complete event sets the COCO and generates an ADC interrupt to wake the MCU from wait mode if the ADC interrupt is enabled ($AIEN = 1$).

10.4.7 MCU Stop3 Mode Operation

Stop mode is a low power-consumption standby mode during which most or all clock sources on the MCU are disabled.

10.4.7.1 Stop3 Mode With ADACK Disabled

If the asynchronous clock, ADACK, is not selected as the conversion clock, executing a stop instruction aborts the current conversion and places the ADC in its idle state. The contents of ADCRH and ADCRL are unaffected by stop3 mode. After exiting from stop3 mode, a software or hardware trigger is required to resume conversions.

10.4.7.2 Stop3 Mode With ADACK Enabled

If ADACK is selected as the conversion clock, the ADC continues operation during stop3 mode. For guaranteed ADC operation, the MCU's voltage regulator must remain active during stop3 mode. Consult the module introduction for configuration information for this MCU.

If a conversion is in progress when the MCU enters stop3 mode, it continues until completion. Conversions can be initiated while the MCU is in stop3 mode by means of the hardware trigger or if continuous conversions are enabled.

A conversion complete event sets the COCO and generates an ADC interrupt to wake the MCU from stop3 mode if the ADC interrupt is enabled ($AIEN = 1$).

NOTE

The ADC module can wake the system from low-power stop and cause the MCU to begin consuming run-level currents without generating a system level interrupt. To prevent this scenario, software should ensure the data transfer blocking mechanism (discussed in [Section 10.4.4.2, “Completing Conversions”](#)) is cleared when entering stop3 and continuing ADC conversions.

10.4.8 MCU Stop2 Mode Operation

The ADC module is automatically disabled when the MCU enters stop2 mode. All module registers contain their reset values following exit from stop2. Therefore, the module must be re-enabled and re-configured following exit from stop2.

10.5 Initialization Information

This section gives an example that provides some basic direction on how to initialize and configure the ADC module. You can configure the module for 8-, 10-, or 12-bit resolution, single or continuous conversion, and a polled or interrupt approach, among many other options. Refer to [Table 10-7](#), [Table 10-8](#), and [Table 10-9](#) for information used in this example.

NOTE

Hexadecimal values designated by a preceding 0x, binary values designated by a preceding %, and decimal values have no preceding character.

10.5.1 ADC Module Initialization Example

10.5.1.1 Initialization Sequence

Before the ADC module can be used to complete conversions, an initialization procedure must be performed. A typical sequence is as follows:

1. Update the configuration register (ADCCFG) to select the input clock source and the divide ratio used to generate the internal clock, ADCK. This register is also used for selecting sample time and low-power configuration.
2. Update status and control register 2 (ADCSC2) to select the conversion trigger (hardware or software) and compare function options, if enabled.
3. Update status and control register 1 (ADCSC1) to select whether conversions will be continuous or completed only once, and to enable or disable conversion complete interrupts. The input channel on which conversions will be performed is also selected here.

10.5.1.2 Pseudo-Code Example

In this example, the ADC module is set up with interrupts enabled to perform a single 10-bit conversion at low power with a long sample time on input channel 1, where the internal ADCK clock is derived from the bus clock divided by 1.

ADCCFG = 0x98 (%10011000)

Bit 7	ADLPC	1	Configures for low power (lowers maximum clock speed)
Bit 6:5	ADIV	00	Sets the ADCK to the input clock ÷ 1
Bit 4	ADLSMP	1	Configures for long sample time
Bit 3:2	MODE	10	Sets mode at 10-bit conversions
Bit 1:0	ADICLK	00	Selects bus clock as input clock source

ADCSC2 = 0x00 (%00000000)

Bit 7	ADACT	0	Flag indicates if a conversion is in progress
Bit 6	ADTRG	0	Software trigger selected
Bit 5	ACFE	0	Compare function disabled
Bit 4	ACFGT	0	Not used in this example
Bit 3:2		00	Reserved, always reads zero
Bit 1:0		00	Reserved for Freescale's internal use; always write zero

ADCSC1 = 0x41 (%01000001)

Bit 7	COCO	0	Read-only flag which is set when a conversion completes
Bit 6	AIEN	1	Conversion complete interrupt enabled
Bit 5	ADCO	0	One conversion only (continuous conversions disabled)
Bit 4:0	ADCH	00001	Input channel 1 selected as ADC input channel

ADCRH/L = 0xxx

Holds results of conversion. Read high byte (ADCRH) before low byte (ADCRL) so that conversion data cannot be overwritten with data from the next conversion.

ADCCVH/L = 0xxx

Holds compare value when compare function enabled

APCTL1=0x02

AD1 pin I/O control disabled. All other AD pins remain general purpose I/O pins

APCTL2=0x00

All other AD pins remain general purpose I/O pins

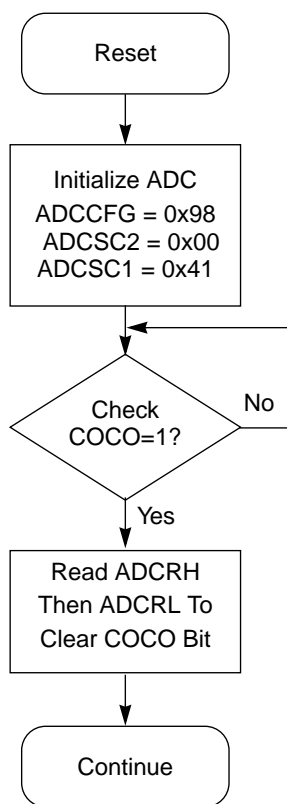

Figure 10-13. Initialization Flowchart for Example

10.6 Application Information

This section contains information for using the ADC module in applications. The ADC has been designed to be integrated into a microcontroller for use in embedded control applications requiring an A/D converter.

10.6.1 External Pins and Routing

The following sections discuss the external pins associated with the ADC module and how they should be used for best results.

10.6.1.1 Analog Supply Pins

The ADC module has analog power and ground supplies (V_{DDAD} and V_{SSAD}) available as separate pins on some devices. V_{SSAD} is shared on the same pin as the MCU digital V_{SS} on some devices. On other devices, V_{SSAD} and V_{DDAD} are shared with the MCU digital supply pins. In these cases, there are separate pads for the analog supplies bonded to the same pin as the corresponding digital supply so that some degree of isolation between the supplies is maintained.

When available on a separate pin, both V_{DDAD} and V_{SSAD} must be connected to the same voltage potential as their corresponding MCU digital supply (V_{DD} and V_{SS}) and must be routed carefully for maximum noise immunity and bypass capacitors placed as near as possible to the package.

If separate power supplies are used for analog and digital power, the ground connection between these supplies must be at the V_{SSAD} pin. This should be the only ground connection between these supplies if possible. The V_{SSAD} pin makes a good single point ground location.

10.6.1.2 Analog Reference Pins

In addition to the analog supplies, the ADC module has connections for two reference voltage inputs. The high reference is V_{REFH} , which may be shared on the same pin as V_{DDAD} on some devices. The low reference is V_{REFL} , which may be shared on the same pin as V_{SSAD} on some devices.

When available on a separate pin, V_{REFH} may be connected to the same potential as V_{DDAD} , or may be driven by an external source between the minimum V_{DDAD} spec and the V_{DDAD} potential (V_{REFH} must never exceed V_{DDAD}). When available on a separate pin, V_{REFL} must be connected to the same voltage potential as V_{SSAD} . V_{REFH} and V_{REFL} must be routed carefully for maximum noise immunity and bypass capacitors placed as near as possible to the package.

AC current in the form of current spikes required to supply charge to the capacitor array at each successive approximation step is drawn through the V_{REFH} and V_{REFL} loop. The best external component to meet this current demand is a 0.1 μF capacitor with good high frequency characteristics. This capacitor is connected between V_{REFH} and V_{REFL} and must be placed as near as possible to the package pins. Resistance in the path is not recommended because the current causes a voltage drop that could result in conversion errors. Inductance in this path must be minimum (parasitic only).

10.6.1.3 Analog Input Pins

The external analog inputs are typically shared with digital I/O pins on MCU devices. The pin I/O control is disabled by setting the appropriate control bit in one of the pin control registers. Conversions can be performed on inputs without the associated pin control register bit set. It is recommended that the pin control register bit always be set when using a pin as an analog input. This avoids problems with contention because the output buffer is in its high impedance state and the pullup is disabled. Also, the input buffer draws DC current when its input is not at V_{DD} or V_{SS} . Setting the pin control register bits for all pins used as analog inputs should be done to achieve lowest operating current.

Empirical data shows that capacitors on the analog inputs improve performance in the presence of noise or when the source impedance is high. Use of 0.01 μF capacitors with good high-frequency characteristics is sufficient. These capacitors are not necessary in all cases, but when used they must be placed as near as possible to the package pins and be referenced to V_{SSA} .

For proper conversion, the input voltage must fall between V_{REFH} and V_{REFL} . If the input is equal to or exceeds V_{REFH} , the converter circuit converts the signal to 0xFFF (full scale 12-bit representation), 0x3FF (full scale 10-bit representation) or 0xFF (full scale 8-bit representation). If the input is equal to or less than V_{REFL} , the converter circuit converts it to 0x000. Input voltages between V_{REFH} and V_{REFL} are straight-line linear conversions. There is a brief current associated with V_{REFL} when the sampling capacitor is charging. The input is sampled for 3.5 cycles of the ADCK source when ADLSMP is low, or 23.5 cycles when ADLSMP is high.

For minimal loss of accuracy due to current injection, pins adjacent to the analog input pins should not be transitioning during conversions.

10.6.2 Sources of Error

Several sources of error exist for A/D conversions. These are discussed in the following sections.

10.6.2.1 Sampling Error

For proper conversions, the input must be sampled long enough to achieve the proper accuracy. Given the maximum input resistance of approximately 7k Ω and input capacitance of approximately 5.5 pF, sampling to within 1/4LSB (at 12-bit resolution) can be achieved within the minimum sample window (3.5 cycles @ 8 MHz maximum ADCK frequency) provided the resistance of the external analog source (R_{AS}) is kept below 2 k Ω .

Higher source resistances or higher-accuracy sampling is possible by setting ADLSMP (to increase the sample window to 23.5 cycles) or decreasing ADCK frequency to increase sample time.

10.6.2.2 Pin Leakage Error

Leakage on the I/O pins can cause conversion error if the external analog source resistance (R_{AS}) is high. If this error cannot be tolerated by the application, keep R_{AS} lower than $V_{DDAD} / (2^N * I_{LEAK})$ for less than 1/4LSB leakage error (N = 8 in 8-bit, 10 in 10-bit or 12 in 12-bit mode).

10.6.2.3 Noise-Induced Errors

System noise that occurs during the sample or conversion process can affect the accuracy of the conversion. The ADC accuracy numbers are guaranteed as specified only if the following conditions are met:

- There is a 0.1 μF low-ESR capacitor from V_{REFH} to V_{REFL} .
- There is a 0.1 μF low-ESR capacitor from V_{DDAD} to V_{SSAD} .
- If inductive isolation is used from the primary supply, an additional 1 μF capacitor is placed from V_{DDAD} to V_{SSAD} .
- V_{SSAD} (and V_{REFL} , if connected) is connected to V_{SS} at a quiet point in the ground plane.
- Operate the MCU in wait or stop3 mode before initiating (hardware triggered conversions) or immediately after initiating (hardware or software triggered conversions) the ADC conversion.
 - For software triggered conversions, immediately follow the write to ADCSC1 with a wait instruction or stop instruction.
 - For stop3 mode operation, select ADACK as the clock source. Operation in stop3 reduces V_{DD} noise but increases effective conversion time due to stop recovery.
- There is no I/O switching, input or output, on the MCU during the conversion.

There are some situations where external system activity causes radiated or conducted noise emissions or excessive V_{DD} noise is coupled into the ADC. In these situations, or when the MCU cannot be placed in wait or stop3 or I/O activity cannot be halted, these recommended actions may reduce the effect of noise on the accuracy:

- Place a 0.01 μF capacitor (C_{AS}) on the selected input channel to V_{REFL} or V_{SSAD} (this improves noise issues, but affects the sample rate based on the external analog source resistance).
- Average the result by converting the analog input many times in succession and dividing the sum of the results. Four samples are required to eliminate the effect of a 1LSB, one-time error.
- Reduce the effect of synchronous noise by operating off the asynchronous clock (ADACK) and averaging. Noise that is synchronous to ADCK cannot be averaged out.

10.6.2.4 Code Width and Quantization Error

The ADC quantizes the ideal straight-line transfer function into 4096 steps (in 12-bit mode). Each step ideally has the same height (1 code) and width. The width is defined as the delta between the transition points to one code and the next. The ideal code width for an N bit converter (in this case N can be 8, 10 or 12), defined as 1LSB, is:

$$1 \text{ lsb} = (V_{\text{REFH}} - V_{\text{REFL}}) / 2^N \quad \text{Eqn. 10-2}$$

There is an inherent quantization error due to the digitization of the result. For 8-bit or 10-bit conversions the code transitions when the voltage is at the midpoint between the points where the straight line transfer function is exactly represented by the actual transfer function. Therefore, the quantization error will be $\pm 1/2$ lsb in 8- or 10-bit mode. As a consequence, however, the code width of the first (0x000) conversion is only 1/2 lsb and the code width of the last (0xFF or 0x3FF) is 1.5 lsb.

For 12-bit conversions the code transitions only after the full code width is present, so the quantization error is -1 lsb to 0 lsb and the code width of each step is 1 lsb.

10.6.2.5 Linearity Errors

The ADC may also exhibit non-linearity of several forms. Every effort has been made to reduce these errors but the system should be aware of them because they affect overall accuracy. These errors are:

- Zero-scale error (E_{ZS}) (sometimes called offset) — This error is defined as the difference between the actual code width of the first conversion and the ideal code width ($1/2$ lsb in 8-bit or 10-bit modes and 1 lsb in 12-bit mode). If the first conversion is $0x001$, the difference between the actual $0x001$ code width and its ideal (1 lsb) is used.
- Full-scale error (E_{FS}) — This error is defined as the difference between the actual code width of the last conversion and the ideal code width (1.5 lsb in 8-bit or 10-bit modes and 1 LSB in 12-bit mode). If the last conversion is $0x3FE$, the difference between the actual $0x3FE$ code width and its ideal (1 LSB) is used.
- Differential non-linearity (DNL) — This error is defined as the worst-case difference between the actual code width and the ideal code width for all conversions.
- Integral non-linearity (INL) — This error is defined as the highest-value the (absolute value of the) running sum of DNL achieves. More simply, this is the worst-case difference of the actual transition voltage to a given code and its corresponding ideal transition voltage, for all codes.
- Total unadjusted error (TUE) — This error is defined as the difference between the actual transfer function and the ideal straight-line transfer function and includes all forms of error.

10.6.2.6 Code Jitter, Non-Monotonicity, and Missing Codes

Analog-to-digital converters are susceptible to three special forms of error. These are code jitter, non-monotonicity, and missing codes.

Code jitter is when, at certain points, a given input voltage converts to one of two values when sampled repeatedly. Ideally, when the input voltage is infinitesimally smaller than the transition voltage, the converter yields the lower code (and vice-versa). However, even small amounts of system noise can cause the converter to be indeterminate (between two codes) for a range of input voltages around the transition voltage. This range is normally around $1/2$ lsb in 8-bit or 10-bit mode, or around 2 lsb in 12-bit mode, and increases with noise.

This error may be reduced by repeatedly sampling the input and averaging the result. Additionally the techniques discussed in [Section 10.6.2.3](#) reduces this error.

Non-monotonicity is defined as when, except for code jitter, the converter converts to a lower code for a higher input voltage. Missing codes are those values never converted for any input value.

In 8-bit or 10-bit mode, the ADC is guaranteed to be monotonic and have no missing codes.

Chapter 11

Inter-Integrated Circuit (S08IICV2)

11.1 Introduction

The inter-integrated circuit (IIC) provides a method of communication between a number of devices. The interface is designed to operate up to 100 kbps with maximum bus loading and timing. The device is capable of operating at higher baud rates, up to a maximum of clock/20, with reduced bus loading. The maximum communication length and the number of devices that can be connected are limited by a maximum bus capacitance of 400 pF.

All MC9S08DZ128 Series MCUs in the 100-pin package have two IICs; devices in the 64-pin and 48-pin packages have one IIC.

NOTE

MC9S08DZ128 Series devices operate at a higher voltage range (2.7 V to 5.5 V) and do not include stop1 mode. Please ignore references to stop1.

11.1.1 IIC1 Configuration Information

The IIC1 module pins, SDA1 and SCL1 can be repositioned under software control using IIC1PS in SOPT1 as shown in [Table 11-1](#). IIC1PS in SOPT1 selects which general-purpose I/O ports are associated with the IIC1 operation.

Table 11-1. IIC1 Position Options

IIC1PS in SOPT1	Port Pin for SCL1	Port Pin for SDA1
0 (default)	PTF2	PTF3
1	PTE4	PTE5

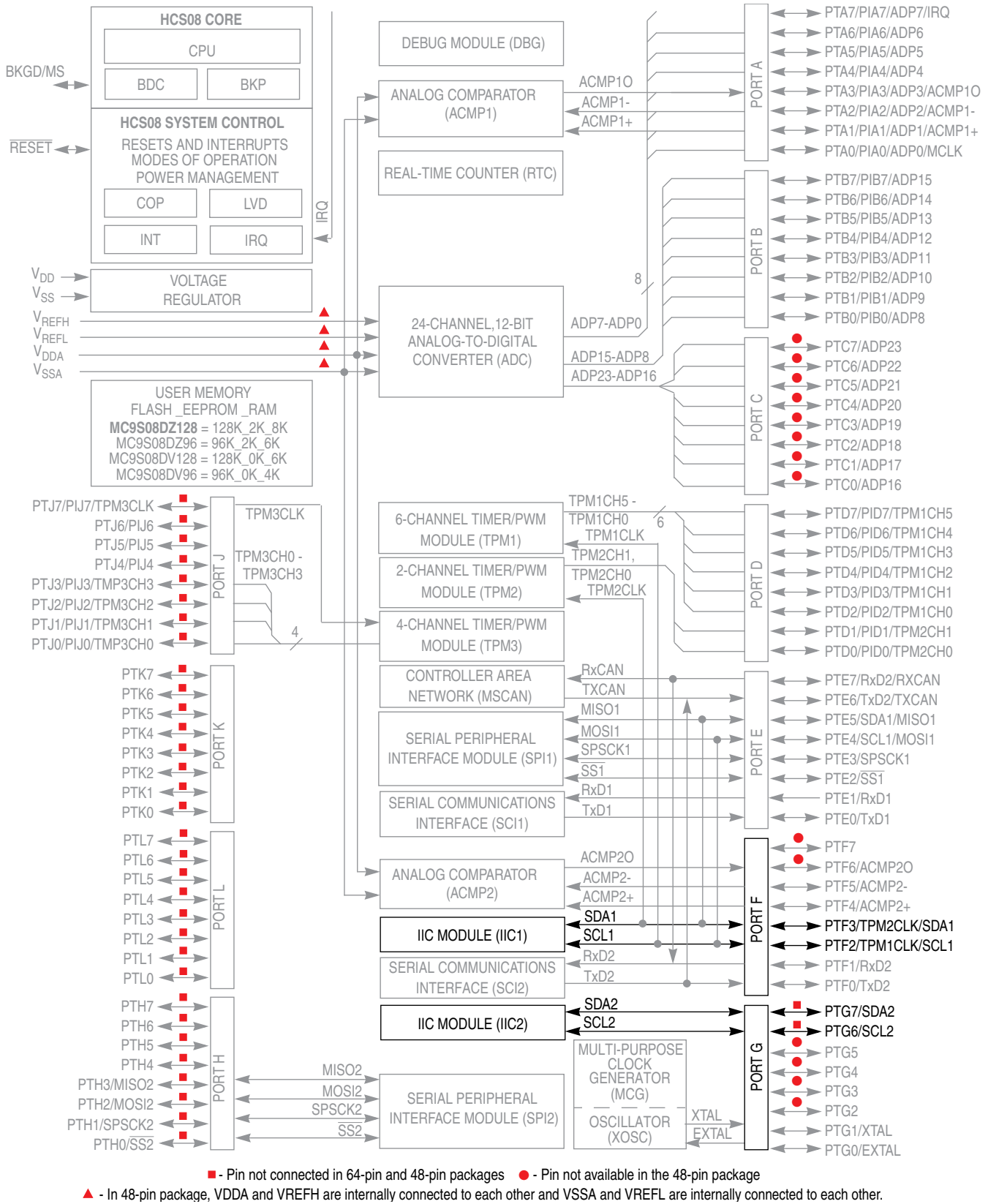

Figure 11-1. MC9S08DZ128 Block Diagram with IIC Highlighted

11.1.2 Features

The IIC includes these distinctive features:

- Compatible with IIC bus standard
- Multi-master operation
- Software programmable for one of 64 different serial clock frequencies
- Software selectable acknowledge bit
- Interrupt driven byte-by-byte data transfer
- Arbitration lost interrupt with automatic mode switching from master to slave
- Calling address identification interrupt
- Start and stop signal generation/detection
- Repeated start signal generation
- Acknowledge bit generation/detection
- Bus busy detection
- General call recognition
- 10-bit address extension

11.1.3 Modes of Operation

A brief description of the IIC in the various MCU modes is given here.

- **Run mode** — This is the basic mode of operation. To conserve power in this mode, disable the module.
- **Wait mode** — The module continues to operate while the MCU is in wait mode and can provide a wake-up interrupt.
- **Stop mode** — The IIC is inactive in stop3 mode for reduced power consumption. The stop instruction does not affect IIC register states. Stop2 resets the register contents.

11.1.4 Block Diagram

Figure 11-2 is a block diagram of the IIC.

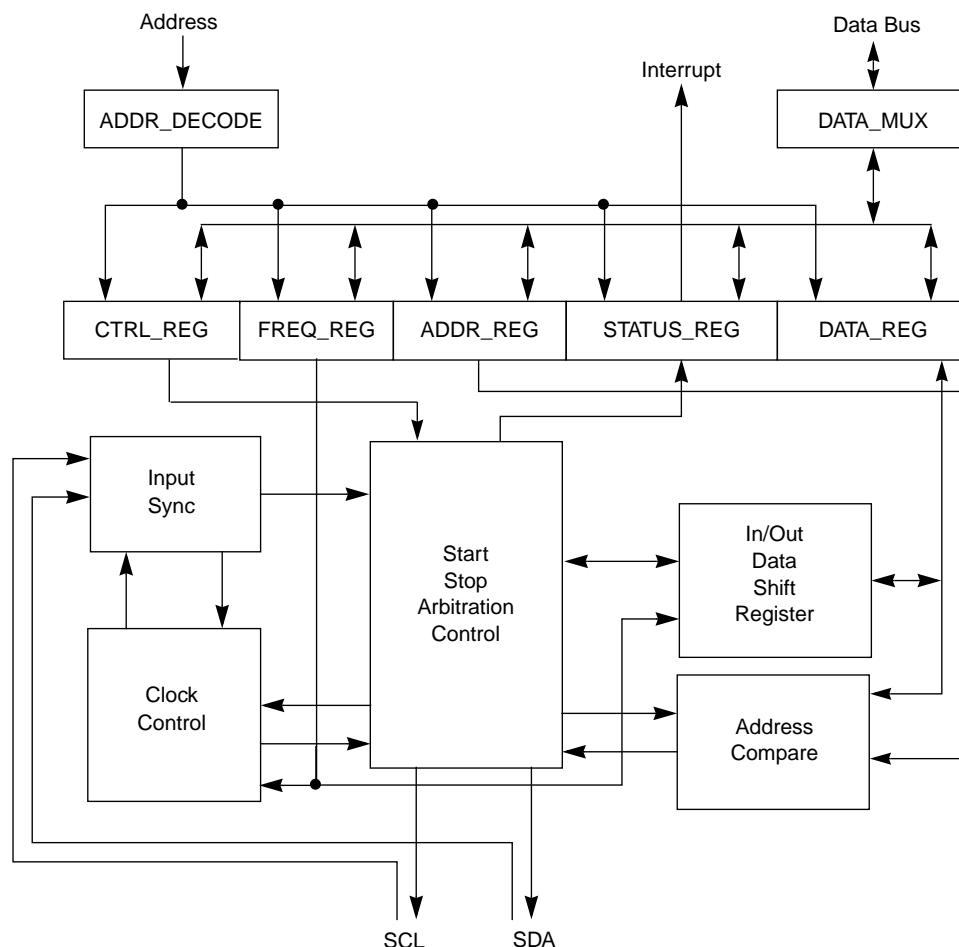

Figure 11-2. IIC Functional Block Diagram

11.2 External Signal Description

This section describes each user-accessible pin signal.

11.2.1 SCL — Serial Clock Line

The bidirectional SCL is the serial clock line of the IIC system.

11.2.2 SDA — Serial Data Line

The bidirectional SDA is the serial data line of the IIC system.

11.3 Register Definition

This section consists of the IIC register descriptions in address order.

Refer to the direct-page register summary in the [memory](#) chapter of this document for the absolute address assignments for all IIC registers. This section refers to registers and control bits only by their names. A Freescale-provided equate or header file is used to translate these names into the appropriate absolute addresses.

11.3.1 IIC Address Register (IICxA)

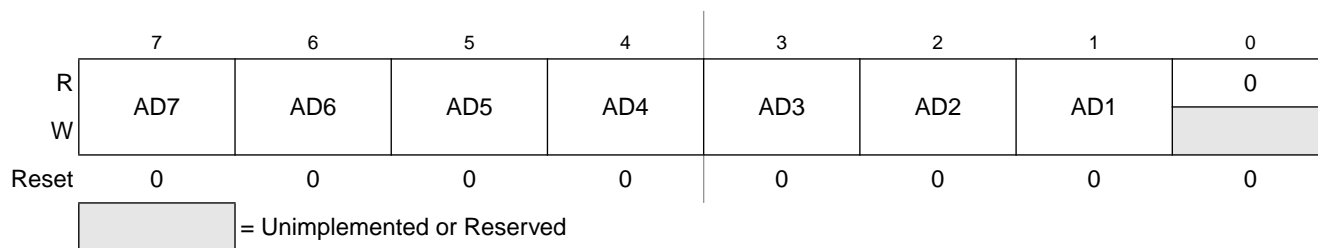

Figure 11-3. IIC Address Register (IICxA)

Table 11-2. IICxA Field Descriptions

Field	Description
7–1 AD[7:1]	Slave Address. The AD[7:1] field contains the slave address to be used by the IIC module. This field is used on the 7-bit address scheme and the lower seven bits of the 10-bit address scheme.

11.3.2 IIC Frequency Divider Register (IICxF)

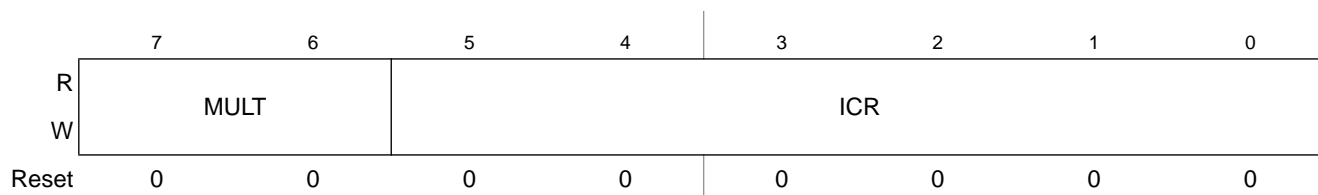

Figure 11-4. IIC Frequency Divider Register (IICxF)

Table 11-3. IICxF Field Descriptions

Field	Description
7–6 MULT	<p>IIC Multiplier Factor. The MULT bits define the multiplier factor, mul. This factor, along with the SCL divider, generates the IIC baud rate. The multiplier factor mul as defined by the MULT bits is provided below.</p> <p>00 mul = 01 01 mul = 02 10 mul = 04 11 Reserved</p>
5–0 ICR	<p>IIC Clock Rate. The ICR bits are used to prescale the bus clock for bit rate selection. These bits and the MULT bits determine the IIC baud rate, the SDA hold time, the SCL Start hold time, and the SCL Stop hold time. Table 11-5 provides the SCL divider and hold values for corresponding values of the ICR.</p> <p>The SCL divider multiplied by multiplier factor mul generates IIC baud rate.</p> $\text{IIC baud rate} = \frac{\text{bus speed (Hz)}}{\text{mul} \times \text{SCLdivider}} \quad \text{Eqn. 11-1}$ <p>SDA hold time is the delay from the falling edge of SCL (IIC clock) to the changing of SDA (IIC data).</p> $\text{SDA hold time} = \text{bus period (s)} \times \text{mul} \times \text{SDA hold value} \quad \text{Eqn. 11-2}$ <p>SCL start hold time is the delay from the falling edge of SDA (IIC data) while SCL is high (Start condition) to the falling edge of SCL (IIC clock).</p> $\text{SCL Start hold time} = \text{bus period (s)} \times \text{mul} \times \text{SCL Start hold value} \quad \text{Eqn. 11-3}$ <p>SCL stop hold time is the delay from the rising edge of SCL (IIC clock) to the rising edge of SDA (IIC data) while SCL is high (Stop condition).</p> $\text{SCL Stop hold time} = \text{bus period (s)} \times \text{mul} \times \text{SCL Stop hold value} \quad \text{Eqn. 11-4}$

For example, if the bus speed is 8 MHz, the table below shows the possible hold time values with different ICR and MULT selections to achieve an IIC baud rate of 100kbps.

Table 11-4. Hold Time Values for 8 MHz Bus Speed

MULT	ICR	Hold Times (μs)		
		SDA	SCL Start	SCL Stop
0x2	0x00	3.500	3.000	5.500
0x1	0x07	2.500	4.000	5.250
0x1	0x0B	2.250	4.000	5.250
0x0	0x14	2.125	4.250	5.125
0x0	0x18	1.125	4.750	5.125

Table 11-5. IIC Divider and Hold Values

ICR (hex)	SCL Divider	SDA Hold Value	SCL Hold (Start) Value	SDA Hold (Stop) Value
00	20	7	6	11
01	22	7	7	12
02	24	8	8	13
03	26	8	9	14
04	28	9	10	15
05	30	9	11	16
06	34	10	13	18
07	40	10	16	21
08	28	7	10	15
09	32	7	12	17
0A	36	9	14	19
0B	40	9	16	21
0C	44	11	18	23
0D	48	11	20	25
0E	56	13	24	29
0F	68	13	30	35
10	48	9	18	25
11	56	9	22	29
12	64	13	26	33
13	72	13	30	37
14	80	17	34	41
15	88	17	38	45
16	104	21	46	53
17	128	21	58	65
18	80	9	38	41
19	96	9	46	49
1A	112	17	54	57
1B	128	17	62	65
1C	144	25	70	73
1D	160	25	78	81
1E	192	33	94	97
1F	240	33	118	121

ICR (hex)	SCL Divider	SDA Hold Value	SCL Hold (Start) Value	SCL Hold (Stop) Value
20	160	17	78	81
21	192	17	94	97
22	224	33	110	113
23	256	33	126	129
24	288	49	142	145
25	320	49	158	161
26	384	65	190	193
27	480	65	238	241
28	320	33	158	161
29	384	33	190	193
2A	448	65	222	225
2B	512	65	254	257
2C	576	97	286	289
2D	640	97	318	321
2E	768	129	382	385
2F	960	129	478	481
30	640	65	318	321
31	768	65	382	385
32	896	129	446	449
33	1024	129	510	513
34	1152	193	574	577
35	1280	193	638	641
36	1536	257	766	769
37	1920	257	958	961
38	1280	129	638	641
39	1536	129	766	769
3A	1792	257	894	897
3B	2048	257	1022	1025
3C	2304	385	1150	1153
3D	2560	385	1278	1281
3E	3072	513	1534	1537
3F	3840	513	1918	1921

11.3.3 IIC Control Register (IICxC1)

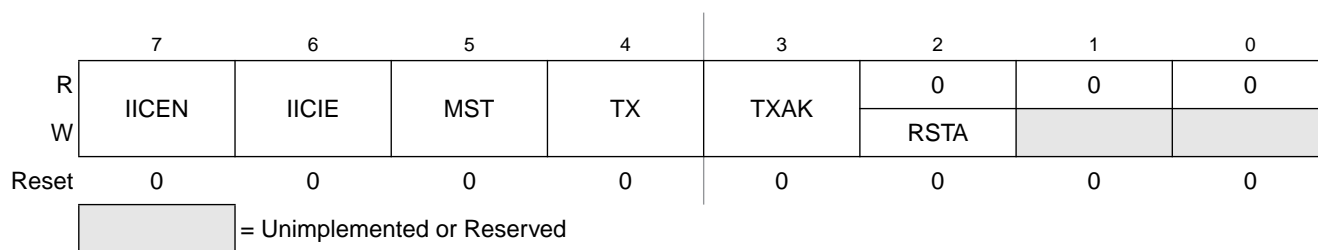

Figure 11-5. IIC Control Register (IICxC1)

Table 11-6. IICxC1 Field Descriptions

Field	Description
7 IICEN	IIC Enable. The IICEN bit determines whether the IIC module is enabled. 0 IIC is not enabled 1 IIC is enabled
6 IICIE	IIC Interrupt Enable. The IICIE bit determines whether an IIC interrupt is requested. 0 IIC interrupt request not enabled 1 IIC interrupt request enabled
5 MST	Master Mode Select. The MST bit changes from a 0 to a 1 when a start signal is generated on the bus and master mode is selected. When this bit changes from a 1 to a 0 a stop signal is generated and the mode of operation changes from master to slave. 0 Slave mode 1 Master mode
4 TX	Transmit Mode Select. The TX bit selects the direction of master and slave transfers. In master mode, this bit should be set according to the type of transfer required. Therefore, for address cycles, this bit is always high. When addressed as a slave, this bit should be set by software according to the SRW bit in the status register. 0 Receive 1 Transmit
3 TXAK	Transmit Acknowledge Enable. This bit specifies the value driven onto the SDA during data acknowledge cycles for master and slave receivers. 0 An acknowledge signal is sent out to the bus after receiving one data byte 1 No acknowledge signal response is sent
2 RSTA	Repeat start. Writing a 1 to this bit generates a repeated start condition provided it is the current master. This bit is always read as cleared. Attempting a repeat at the wrong time results in loss of arbitration.

11.3.4 IIC Status Register (IICxS)

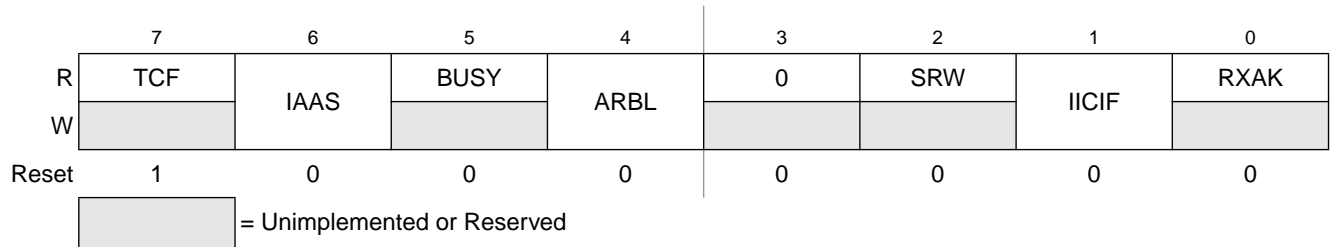

Figure 11-6. IIC Status Register (IICxS)

Table 11-7. IICxS Field Descriptions

Field	Description
7 TCF	Transfer Complete Flag. This bit is set on the completion of a byte transfer. This bit is only valid during or immediately following a transfer to the IIC module or from the IIC module. The TCF bit is cleared by reading the IICxD register in receive mode or writing to the IICxD in transmit mode. 0 Transfer in progress 1 Transfer complete
6 IAAS	Addressed as a Slave. The IAAS bit is set when the calling address matches the programmed slave address or when the GCAEN bit is set and a general call is received. Writing the IICxC register clears this bit. 0 Not addressed 1 Addressed as a slave
5 BUSY	Bus Busy. The BUSY bit indicates the status of the bus regardless of slave or master mode. The BUSY bit is set when a start signal is detected and cleared when a stop signal is detected. 0 Bus is idle 1 Bus is busy
4 ARBL	Arbitration Lost. This bit is set by hardware when the arbitration procedure is lost. The ARBL bit must be cleared by software by writing a 1 to it. 0 Standard bus operation 1 Loss of arbitration
2 SRW	Slave Read/Write. When addressed as a slave, the SRW bit indicates the value of the R/W command bit of the calling address sent to the master. 0 Slave receive, master writing to slave 1 Slave transmit, master reading from slave
1 IICIF	IIC Interrupt Flag. The IICIF bit is set when an interrupt is pending. This bit must be cleared by software, by writing a 1 to it in the interrupt routine. One of the following events can set the IICIF bit: <ul style="list-style-type: none"> • One byte transfer completes • Match of slave address to calling address • Arbitration lost 0 No interrupt pending 1 Interrupt pending
0 RXAK	Receive Acknowledge. When the RXAK bit is low, it indicates an acknowledge signal has been received after the completion of one byte of data transmission on the bus. If the RXAK bit is high it means that no acknowledge signal is detected. 0 Acknowledge received 1 No acknowledge received

11.3.5 IIC Data I/O Register (IICxD)

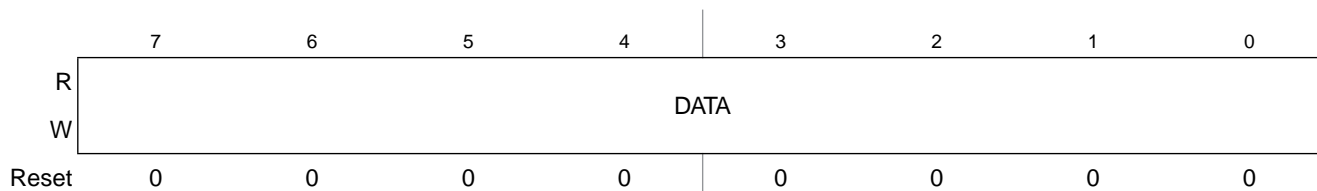

Figure 11-7. IIC Data I/O Register (IICxD)

Table 11-8. IICxD Field Descriptions

Field	Description
7–0 DATA	Data — In master transmit mode, when data is written to the IICxD, a data transfer is initiated. The most significant bit is sent first. In master receive mode, reading this register initiates receiving of the next byte of data.

NOTE

When transitioning out of master receive mode, the IIC mode should be switched before reading the IICxD register to prevent an inadvertent initiation of a master receive data transfer.

In slave mode, the same functions are available after an address match has occurred.

The TX bit in IICxC must correctly reflect the desired direction of transfer in master and slave modes for the transmission to begin. For instance, if the IIC is configured for master transmit but a master receive is desired, reading the IICxD does not initiate the receive.

Reading the IICxD returns the last byte received while the IIC is configured in master receive or slave receive modes. The IICxD does not reflect every byte transmitted on the IIC bus, nor can software verify that a byte has been written to the IICxD correctly by reading it back.

In master transmit mode, the first byte of data written to IICxD following assertion of MST is used for the address transfer and should comprise of the calling address (in bit 7 to bit 1) concatenated with the required R/\overline{W} bit (in position bit 0).

11.3.6 IIC Control Register 2 (IICxC2)

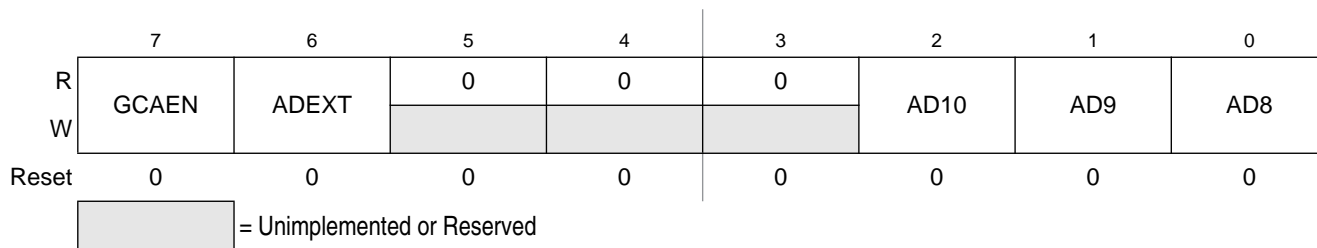

Figure 11-8. IIC Control Register (IICxC2)

Table 11-9. IICxC2 Field Descriptions

Field	Description
7 GCAEN	General Call Address Enable. The GCAEN bit enables or disables general call address. 0 General call address is disabled 1 General call address is enabled
6 ADEXT	Address Extension. The ADEXT bit controls the number of bits used for the slave address. 0 7-bit address scheme 1 10-bit address scheme
2–0 AD[10:8]	Slave Address. The AD[10:8] field contains the upper three bits of the slave address in the 10-bit address scheme. This field is only valid when the ADEXT bit is set.

11.4 Functional Description

This section provides a complete functional description of the IIC module.

11.4.1 IIC Protocol

The IIC bus system uses a serial data line (SDA) and a serial clock line (SCL) for data transfer. All devices connected to it must have open drain or open collector outputs. A logic AND function is exercised on both lines with external pull-up resistors. The value of these resistors is system dependent.

Normally, a standard communication is composed of four parts:

- Start signal
- Slave address transmission
- Data transfer
- Stop signal

The stop signal should not be confused with the CPU stop instruction. The IIC bus system communication is described briefly in the following sections and illustrated in [Figure 11-9](#).

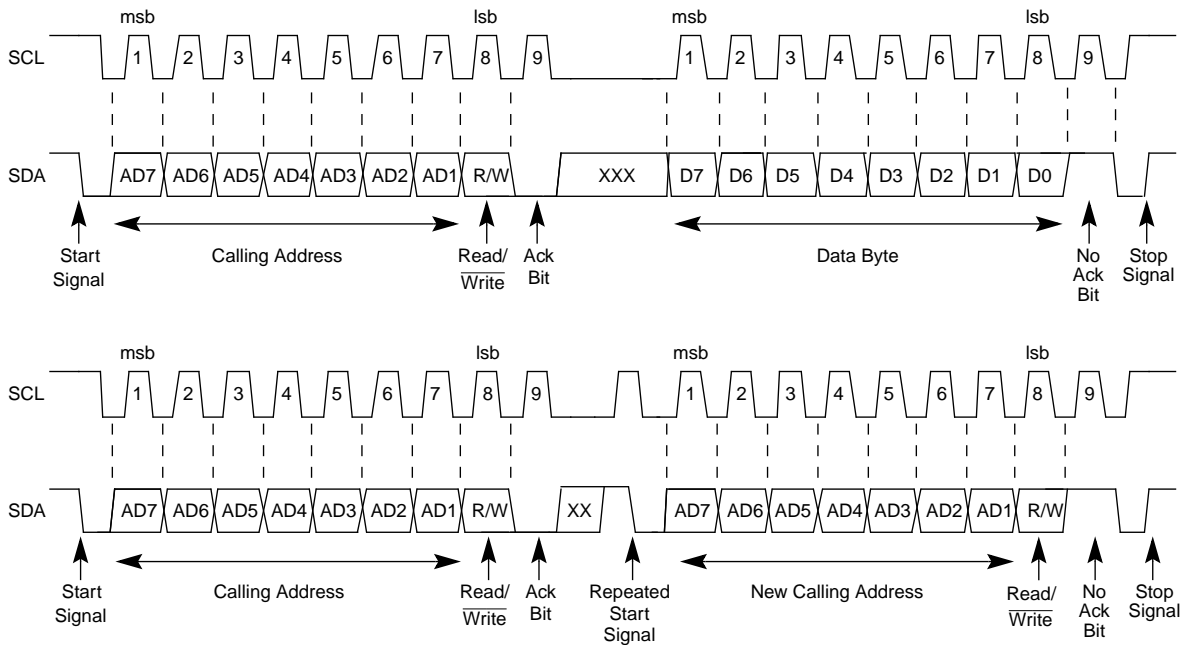

Figure 11-9. IIC Bus Transmission Signals

11.4.1.1 Start Signal

When the bus is free, no master device is engaging the bus (SCL and SDA lines are at logical high), a master may initiate communication by sending a start signal. As shown in Figure 11-9, a start signal is defined as a high-to-low transition of SDA while SCL is high. This signal denotes the beginning of a new data transfer (each data transfer may contain several bytes of data) and brings all slaves out of their idle states.

11.4.1.2 Slave Address Transmission

The first byte of data transferred immediately after the start signal is the slave address transmitted by the master. This is a seven-bit calling address followed by a R/\overline{W} bit. The R/\overline{W} bit tells the slave the desired direction of data transfer.

- 1 = Read transfer, the slave transmits data to the master.
- 0 = Write transfer, the master transmits data to the slave.

Only the slave with a calling address that matches the one transmitted by the master responds by sending back an acknowledge bit. This is done by pulling the SDA low at the ninth clock (see Figure 11-9).

No two slaves in the system may have the same address. If the IIC module is the master, it must not transmit an address equal to its own slave address. The IIC cannot be master and slave at the same time. However, if arbitration is lost during an address cycle, the IIC reverts to slave mode and operates correctly even if it is being addressed by another master.

11.4.1.3 Data Transfer

Before successful slave addressing is achieved, the data transfer can proceed byte-by-byte in a direction specified by the R/\overline{W} bit sent by the calling master.

All transfers that come after an address cycle are referred to as data transfers, even if they carry sub-address information for the slave device

Each data byte is 8 bits long. Data may be changed only while SCL is low and must be held stable while SCL is high as shown in [Figure 11-9](#). There is one clock pulse on SCL for each data bit, the msb being transferred first. Each data byte is followed by a 9th (acknowledge) bit, which is signalled from the receiving device. An acknowledge is signalled by pulling the SDA low at the ninth clock. In summary, one complete data transfer needs nine clock pulses.

If the slave receiver does not acknowledge the master in the ninth bit time, the SDA line must be left high by the slave. The master interprets the failed acknowledge as an unsuccessful data transfer.

If the master receiver does not acknowledge the slave transmitter after a data byte transmission, the slave interprets this as an end of data transfer and releases the SDA line.

In either case, the data transfer is aborted and the master does one of two things:

- Relinquishes the bus by generating a stop signal.
- Commences a new calling by generating a repeated start signal.

11.4.1.4 Stop Signal

The master can terminate the communication by generating a stop signal to free the bus. However, the master may generate a start signal followed by a calling command without generating a stop signal first. This is called repeated start. A stop signal is defined as a low-to-high transition of SDA while SCL at logical 1 (see [Figure 11-9](#)).

The master can generate a stop even if the slave has generated an acknowledge at which point the slave must release the bus.

11.4.1.5 Repeated Start Signal

As shown in [Figure 11-9](#), a repeated start signal is a start signal generated without first generating a stop signal to terminate the communication. This is used by the master to communicate with another slave or with the same slave in different mode (transmit/receive mode) without releasing the bus.

11.4.1.6 Arbitration Procedure

The IIC bus is a true multi-master bus that allows more than one master to be connected on it. If two or more masters try to control the bus at the same time, a clock synchronization procedure determines the bus clock, for which the low period is equal to the longest clock low period and the high is equal to the shortest one among the masters. The relative priority of the contending masters is determined by a data arbitration procedure, a bus master loses arbitration if it transmits logic 1 while another master transmits logic 0. The losing masters immediately switch over to slave receive mode and stop driving SDA output. In this case,

the transition from master to slave mode does not generate a stop condition. Meanwhile, a status bit is set by hardware to indicate loss of arbitration.

11.4.1.7 Clock Synchronization

Because wire-AND logic is performed on the SCL line, a high-to-low transition on the SCL line affects all the devices connected on the bus. The devices start counting their low period and after a device's clock has gone low, it holds the SCL line low until the clock high state is reached. However, the change of low to high in this device clock may not change the state of the SCL line if another device clock is still within its low period. Therefore, synchronized clock SCL is held low by the device with the longest low period. Devices with shorter low periods enter a high wait state during this time (see Figure 11-10). When all devices concerned have counted off their low period, the synchronized clock SCL line is released and pulled high. There is then no difference between the device clocks and the state of the SCL line and all the devices start counting their high periods. The first device to complete its high period pulls the SCL line low again.

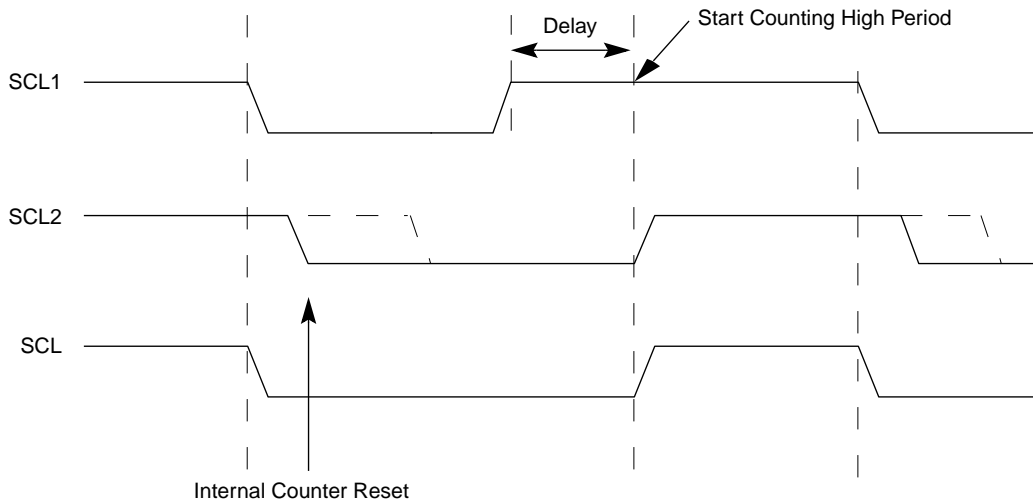

Figure 11-10. IIC Clock Synchronization

11.4.1.8 Handshaking

The clock synchronization mechanism can be used as a handshake in data transfer. Slave devices may hold the SCL low after completion of one byte transfer (9 bits). In such a case, it halts the bus clock and forces the master clock into wait states until the slave releases the SCL line.

11.4.1.9 Clock Stretching

The clock synchronization mechanism can be used by slaves to slow down the bit rate of a transfer. After the master has driven SCL low the slave can drive SCL low for the required period and then release it. If the slave SCL low period is greater than the master SCL low period then the resulting SCL bus signal low period is stretched.

11.4.2 10-bit Address

For 10-bit addressing, 0x11110 is used for the first 5 bits of the first address byte. Various combinations of read/write formats are possible within a transfer that includes 10-bit addressing.

11.4.2.1 Master-Transmitter Addresses a Slave-Receiver

The transfer direction is not changed (see Table 11-10). When a 10-bit address follows a start condition, each slave compares the first seven bits of the first byte of the slave address (11110XX) with its own address and tests whether the eighth bit (R/\overline{W} direction bit) is 0. More than one device can find a match and generate an acknowledge (A1). Then, each slave that finds a match compares the eight bits of the second byte of the slave address with its own address. Only one slave finds a match and generates an acknowledge (A2). The matching slave remains addressed by the master until it receives a stop condition (P) or a repeated start condition (Sr) followed by a different slave address.

S	Slave Address 1st 7 bits 11110 + AD10 + AD9	R/W 0	A1	Slave Address 2nd byte AD[8:1]	A2	Data	A	...	Data	A/A	P
---	--	----------	----	-----------------------------------	----	------	---	-----	------	-----	---

Table 11-10. Master-Transmitter Addresses Slave-Receiver with a 10-bit Address

After the master-transmitter has sent the first byte of the 10-bit address, the slave-receiver sees an IIC interrupt. Software must ensure the contents of IICD are ignored and not treated as valid data for this interrupt.

11.4.2.2 Master-Receiver Addresses a Slave-Transmitter

The transfer direction is changed after the second R/\overline{W} bit (see Table 11-11). Up to and including acknowledge bit A2, the procedure is the same as that described for a master-transmitter addressing a slave-receiver. After the repeated start condition (Sr), a matching slave remembers that it was addressed before. This slave then checks whether the first seven bits of the first byte of the slave address following Sr are the same as they were after the start condition (S) and tests whether the eighth (R/\overline{W}) bit is 1. If there is a match, the slave considers that it has been addressed as a transmitter and generates acknowledge A3. The slave-transmitter remains addressed until it receives a stop condition (P) or a repeated start condition (Sr) followed by a different slave address.

After a repeated start condition (Sr), all other slave devices also compare the first seven bits of the first byte of the slave address with their own addresses and test the eighth (R/\overline{W}) bit. However, none of them are addressed because $R/\overline{W} = 1$ (for 10-bit devices) or the 11110XX slave address (for 7-bit devices) does not match.

S	Slave Address 1st 7 bits 11110 + AD10 + AD9	R/W 0	A1	Slave Address 2nd byte AD[8:1]	A2	Sr	Slave Address 1st 7 bits 11110 + AD10 + AD9	R/W 1	A3	Data	A	...	Data	A	P
---	--	----------	----	-----------------------------------	----	----	--	----------	----	------	---	-----	------	---	---

Table 11-11. Master-Receiver Addresses a Slave-Transmitter with a 10-bit Address

After the master-receiver has sent the first byte of the 10-bit address, the slave-transmitter sees an IIC interrupt. Software must ensure the contents of IICD are ignored and not treated as valid data for this interrupt.

11.4.3 General Call Address

General calls can be requested in 7-bit address or 10-bit address. If the GCAEN bit is set, the IIC matches the general call address as well as its own slave address. When the IIC responds to a general call, it acts as a slave-receiver and the IAAS bit is set after the address cycle. Software must read the IICD register after the first byte transfer to determine whether the address matches its own slave address or a general call. If the value is 00, the match is a general call. If the GCAEN bit is clear, the IIC ignores any data supplied from a general call address by not issuing an acknowledgement.

11.5 Resets

The IIC is disabled after reset. The IIC cannot cause an MCU reset.

11.6 Interrupts

The IIC generates a single interrupt.

An interrupt from the IIC is generated when any of the events in Table 11-12 occur, provided the IICIE bit is set. The interrupt is driven by bit IICIF (of the IIC status register) and masked with bit IICIE (of the IIC control register). The IICIF bit must be cleared by software by writing a 1 to it in the interrupt routine. You can determine the interrupt type by reading the status register.

Table 11-12. Interrupt Summary

Interrupt Source	Status	Flag	Local Enable
Complete 1-byte transfer	TCF	IICIF	IICIE
Match of received calling address	IAAS	IICIF	IICIE
Arbitration Lost	ARBL	IICIF	IICIE

11.6.1 Byte Transfer Interrupt

The TCF (transfer complete flag) bit is set at the falling edge of the ninth clock to indicate the completion of byte transfer.

11.6.2 Address Detect Interrupt

When the calling address matches the programmed slave address (IIC address register) or when the GCAEN bit is set and a general call is received, the IAAS bit in the status register is set. The CPU is interrupted, provided the IICIE is set. The CPU must check the SRW bit and set its Tx mode accordingly.

11.6.3 Arbitration Lost Interrupt

The IIC is a true multi-master bus that allows more than one master to be connected on it. If two or more masters try to control the bus at the same time, the relative priority of the contending masters is determined by a data arbitration procedure. The IIC module asserts this interrupt when it loses the data arbitration process and the ARBL bit in the status register is set.

Arbitration is lost in the following circumstances:

- SDA sampled as a low when the master drives a high during an address or data transmit cycle.
- SDA sampled as a low when the master drives a high during the acknowledge bit of a data receive cycle.
- A start cycle is attempted when the bus is busy.
- A repeated start cycle is requested in slave mode.
- A stop condition is detected when the master did not request it.

This bit must be cleared by software writing a 1 to it.

11.7 Initialization/Application Information

Module Initialization (Slave)

1. Write: IICC2
 - to enable or disable general call
 - to select 10-bit or 7-bit addressing mode
2. Write: IICA
 - to set the slave address
3. Write: IICC1
 - to enable IIC and interrupts
4. Initialize RAM variables (IICEN = 1 and IICIE = 1) for transmit data
5. Initialize RAM variables used to achieve the routine shown in [Figure 11-12](#)

Module Initialization (Master)

1. Write: IICF
 - to set the IIC baud rate (example provided in this chapter)
2. Write: IICC1
 - to enable IIC and interrupts
3. Initialize RAM variables (IICEN = 1 and IICIE = 1) for transmit data
4. Initialize RAM variables used to achieve the routine shown in [Figure 11-12](#)
5. Write: IICC1
 - to enable TX
6. Write: IICC1
 - to enable MST (master mode)
7. Write: IICD
 - with the address of the target slave. (The lsb of this byte determines whether the communication is master receive or transmit.)

Module Use

The routine shown in [Figure 11-12](#) can handle both master and slave IIC operations. For slave operation, an incoming IIC message that contains the proper address begins IIC communication. For master operation, communication must be initiated by writing to the IICD register.

Register Model

IICA	AD[7:1]							0
When addressed as a slave (in slave mode), the module responds to this address								
IICF	MULT				ICR			
Baud rate = BUSCLK / (2 x MULT x (SCL DIVIDER))								
IICC1	IICEN	IICIE	MST	TX	TXAK	RSTA	0	0
Module configuration								
IICS	TCF	IAAS	BUSY	ARBL	0	SRW	IICIF	RXAK
Module status flags								
IICD	DATA							
Data register; Write to transmit IIC data read to read IIC data								
IICC2	GCAEN	ADEXT	0	0	0	AD10	AD9	AD8
Address configuration								

Figure 11-11. IIC Module Quick Start

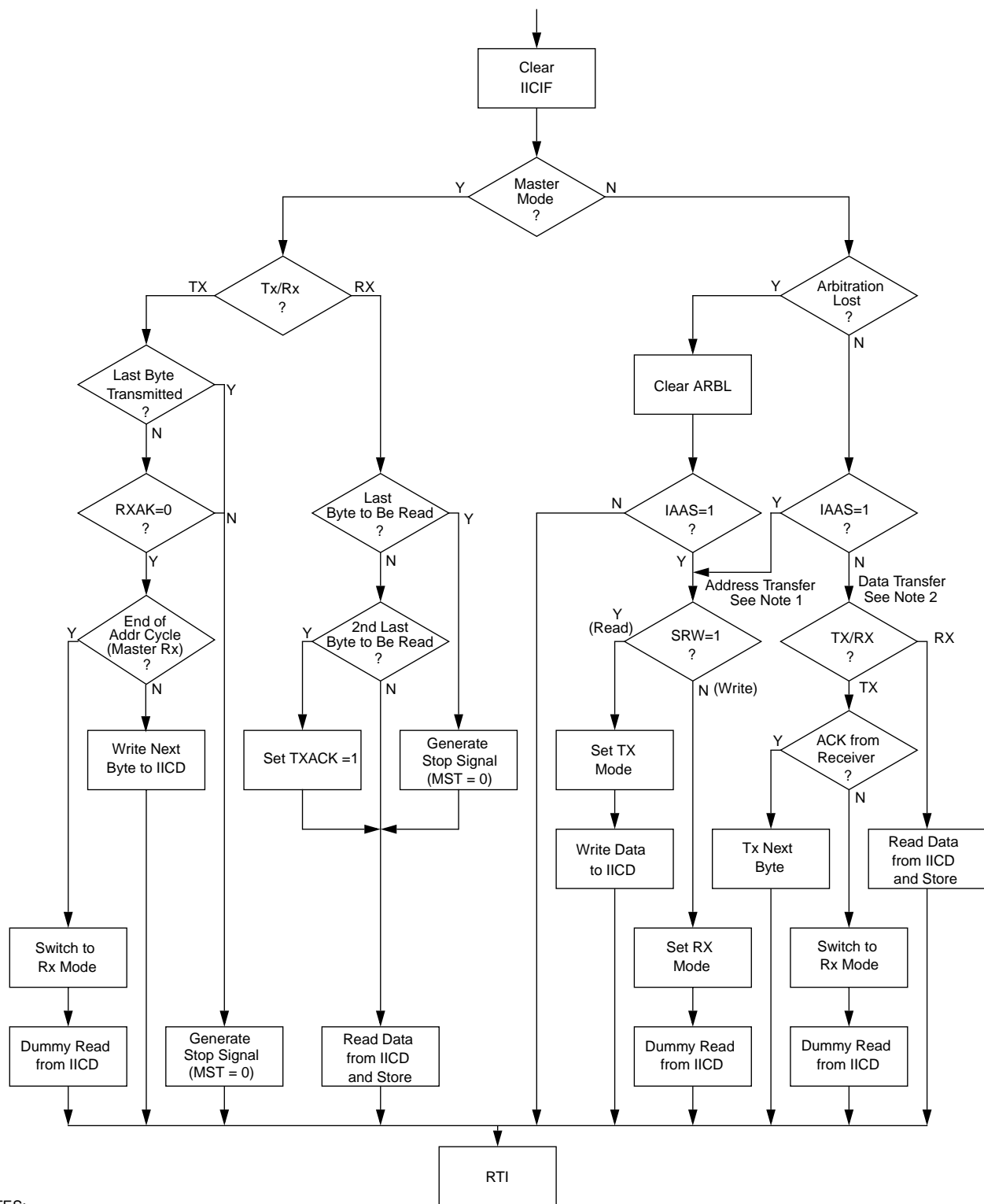

NOTES:

1. If general call is enabled, a check must be done to determine whether the received address was a general call address (0x00). If the received address was a general call address, then the general call must be handled by user software.
2. When 10-bit addressing is used to address a slave, the slave sees an interrupt following the first byte of the extended address. User software must ensure that for this interrupt, the contents of IICD are ignored and not treated as a valid data transfer

Figure 11-12. Typical IIC Interrupt Routine

Chapter 12

Freescale's Controller Area Network (S08MSCANV1)

12.1 Introduction

Freescale's controller area network (MSCAN) is a communication controller implementing the CAN 2.0A/B protocol as defined in the Bosch specification dated September 1991. To fully understand the MSCAN specification, it is recommended that the Bosch specification be read first to gain familiarity with the terms and concepts contained within this document.

Though not exclusively intended for automotive applications, CAN protocol is designed to meet the specific requirements of a vehicle serial data bus: real-time processing, reliable operation in the EMI environment of a vehicle, cost-effectiveness, and required bandwidth.

MSCAN uses an advanced buffer arrangement resulting in predictable real-time behavior and simplified application software.

The MSCAN module is available in all devices in the MC9S08DZ128 Series.

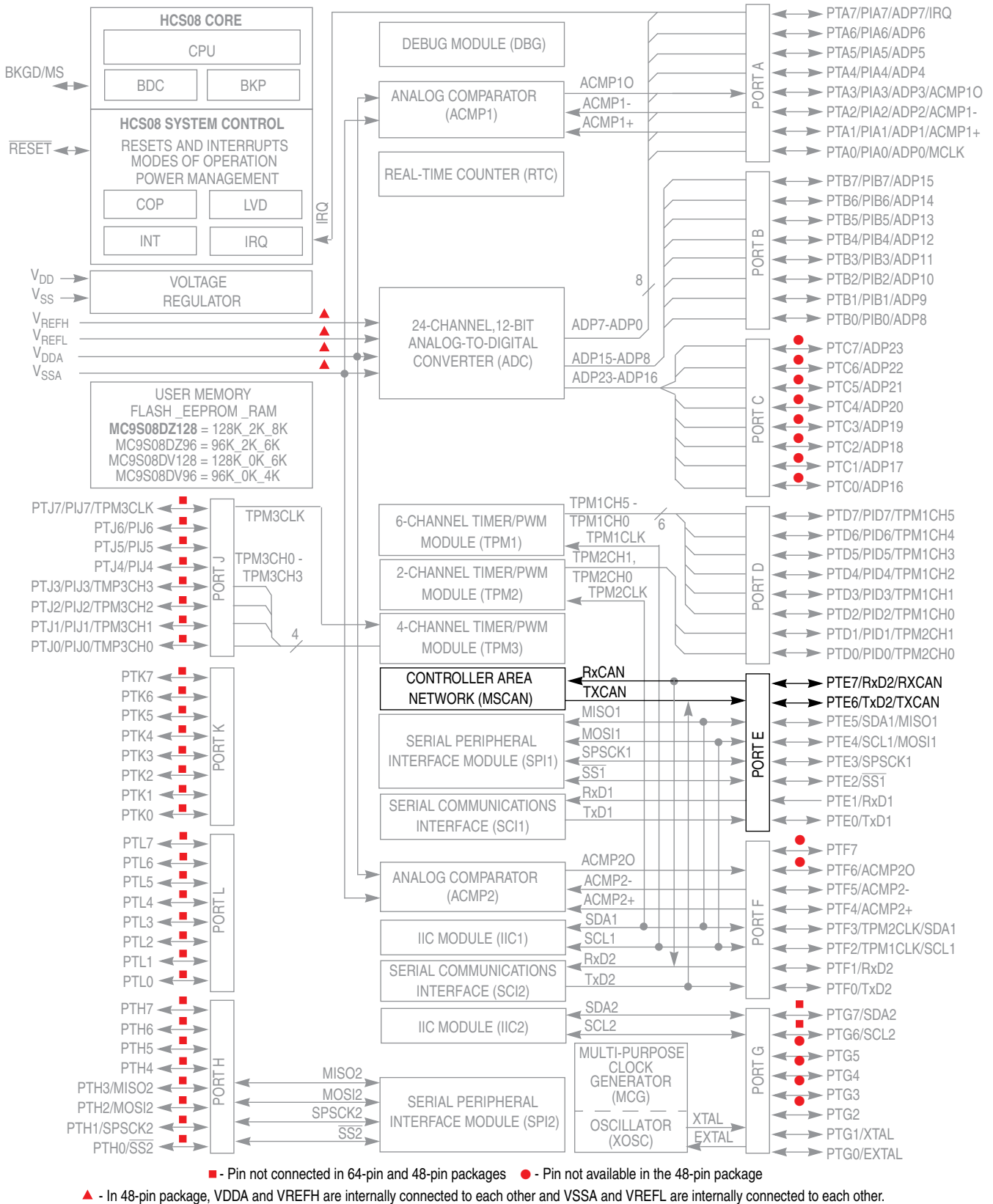

Figure 12-1. MC9S08DZ128 Block Diagram with MSCAN Highlighted

12.1.1 Features

The basic features of the MSCAN are as follows:

- Implementation of the CAN protocol — Version 2.0A/B
 - Standard and extended data frames
 - Zero to eight bytes data length
 - Programmable bit rate up to 1 Mbps¹
 - Support for remote frames
- Five receive buffers with FIFO storage scheme
- Three transmit buffers with internal prioritization using a “local priority” concept
- Flexible maskable identifier filter supports two full-size (32-bit) extended identifier filters, or four 16-bit filters, or eight 8-bit filters
- Programmable wakeup functionality with integrated low-pass filter
- Programmable loopback mode supports self-test operation
- Programmable listen-only mode for monitoring of CAN bus
- Programmable bus-off recovery functionality
- Separate signalling and interrupt capabilities for all CAN receiver and transmitter error states (warning, error passive, bus-off)
- Programmable MSCAN clock source either bus clock or oscillator clock
- Internal timer for time-stamping of received and transmitted messages
- Three low-power modes: sleep, power down, and MSCAN enable
- Global initialization of configuration registers

12.1.2 Modes of Operation

The following modes of operation are specific to the MSCAN. See [Section 12.5, “Functional Description,”](#) for details.

- Listen-Only Mode
- MSCAN Sleep Mode
- MSCAN Initialization Mode
- MSCAN Power Down Mode
- Loopback Self Test Mode

1. Depending on the actual bit timing and the clock jitter of the PLL.

12.1.3 Block Diagram

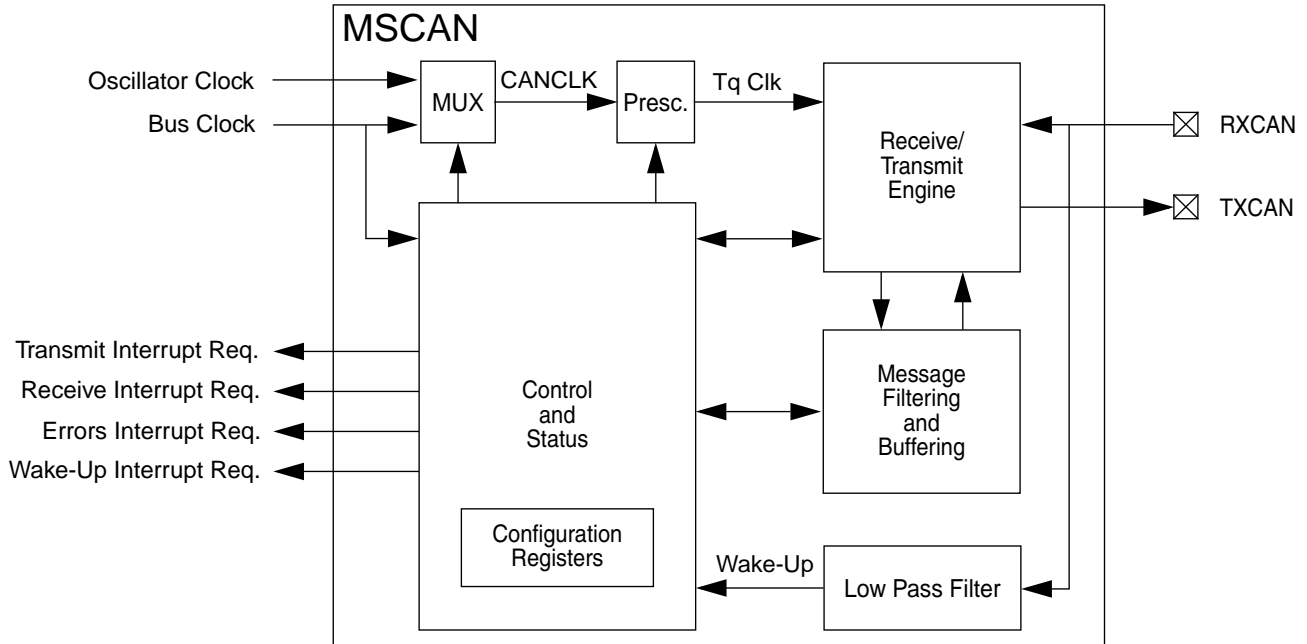

Figure 12-2. MSCAN Block Diagram

12.2 External Signal Description

The MSCAN uses two external pins:

12.2.1 RXCAN — CAN Receiver Input Pin

RXCAN is the MSCAN receiver input pin.

12.2.2 TXCAN — CAN Transmitter Output Pin

TXCAN is the MSCAN transmitter output pin. The TXCAN output pin represents the logic level on the CAN bus:

- 0 = Dominant state
- 1 = Recessive state

12.2.3 CAN System

A typical CAN system with MSCAN is shown in Figure 12-3. Each CAN node is connected physically to the CAN bus lines through a transceiver device. The transceiver is capable of driving the large current needed for the CAN bus and has current protection against defective CAN or defective nodes.

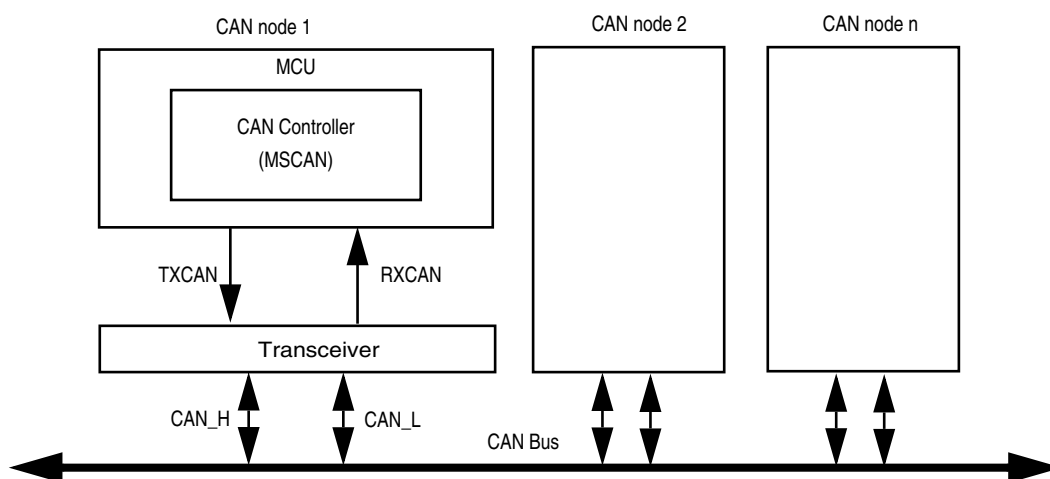

Figure 12-3. CAN System

12.3 Register Definition

This section describes in detail all the registers and register bits in the MSCAN module. Each description includes a standard register diagram with an associated figure number. Details of register bit and field function follow the register diagrams, in bit order. All bits of all registers in this module are completely synchronous to internal clocks during a register read.

12.3.1 MSCAN Control Register 0 (CANCTL0)

The CANCTL0 register provides various control bits of the MSCAN module as described below.

	7	6	5	4	3	2	1	0
R	RXFRM	RXACT	CSWAI	SYNCH	TIME	WUPE	SLPRQ	INITRQ
W								
Reset:	0	0	0	0	0	0	0	1

= Unimplemented

Figure 12-4. MSCAN Control Register 0 (CANCTL0)

NOTE

The CANCTL0 register, except WUPE, INITRQ, and SLPRQ, is held in the reset state when the initialization mode is active (INITRQ = 1 and INITAK = 1). This register is writable again as soon as the initialization mode is exited (INITRQ = 0 and INITAK = 0).

Read: Anytime

Write: Anytime when out of initialization mode; exceptions are read-only RXACT and SYNCH, RXFRM (which is set by the module only), and INITRQ (which is also writable in initialization mode).

Table 12-1. CANCTL0 Register Field Descriptions

Field	Description
7 RXFRM ¹	Received Frame Flag — This bit is read and clear only. It is set when a receiver has received a valid message correctly, independently of the filter configuration. After it is set, it remains set until cleared by software or reset. Clearing is done by writing a 1. Writing a 0 is ignored. This bit is not valid in loopback mode. 0 No valid message was received since last clearing this flag 1 A valid message was received since last clearing of this flag
6 RXACT	Receiver Active Status — This read-only flag indicates the MSCAN is receiving a message. The flag is controlled by the receiver front end. This bit is not valid in loopback mode. 0 MSCAN is transmitting or idle ² 1 MSCAN is receiving a message (including when arbitration is lost) ²
5 CSWAI ³	CAN Stops in Wait Mode — Enabling this bit allows for lower power consumption in wait mode by disabling all the clocks at the CPU bus interface to the MSCAN module. 0 The module is not affected during wait mode 1 The module ceases to be clocked during wait mode
4 SYNCH	Synchronized Status — This read-only flag indicates whether the MSCAN is synchronized to the CAN bus and able to participate in the communication process. It is set and cleared by the MSCAN. 0 MSCAN is not synchronized to the CAN bus 1 MSCAN is synchronized to the CAN bus
3 TIME	Timer Enable — This bit activates an internal 16-bit wide free running timer which is clocked by the bit clock rate. If the timer is enabled, a 16-bit time stamp will be assigned to each transmitted/received message within the active TX/RX buffer. As soon as a message is acknowledged on the CAN bus, the time stamp will be written to the highest bytes (0x000E, 0x000F) in the appropriate buffer (see Section 12.4, “Programmer’s Model of Message Storage”). The internal timer is reset (all bits set to 0) when disabled. This bit is held low in initialization mode. 0 Disable internal MSCAN timer 1 Enable internal MSCAN timer
2 WUPE ⁴	Wake-Up Enable — This configuration bit allows the MSCAN to restart from sleep mode when traffic on CAN is detected (see Section 12.5.5.4, “MSCAN Sleep Mode”). This bit must be configured before sleep mode entry for the selected function to take effect. 0 Wake-up disabled — The MSCAN ignores traffic on CAN 1 Wake-up enabled — The MSCAN is able to restart

Table 12-1. CANCTL0 Register Field Descriptions (continued)

Field	Description
1 SLPRQ ⁵	<p>Sleep Mode Request — This bit requests the MSCAN to enter sleep mode, which is an internal power saving mode (see Section 12.5.5.4, “MSCAN Sleep Mode”). The sleep mode request is serviced when the CAN bus is idle, i.e., the module is not receiving a message and all transmit buffers are empty. The module indicates entry to sleep mode by setting SLPK = 1 (see Section 12.3.2, “MSCAN Control Register 1 (CANCTL1)”). SLPRQ cannot be set while the WUPIF flag is set (see Section 12.3.4.1, “MSCAN Receiver Flag Register (CANRFLG)”). Sleep mode will be active until SLPRQ is cleared by the CPU or, depending on the setting of WUPE, the MSCAN detects activity on the CAN bus and clears SLPRQ itself.</p> <p>0 Running — The MSCAN functions normally 1 Sleep mode request — The MSCAN enters sleep mode when CAN bus idle</p>
0 INITRQ ^{6,7}	<p>Initialization Mode Request — When this bit is set by the CPU, the MSCAN skips to initialization mode (see Section 12.5.5.5, “MSCAN Initialization Mode”). Any ongoing transmission or reception is aborted and synchronization to the CAN bus is lost. The module indicates entry to initialization mode by setting INITAK = 1 (Section 12.3.2, “MSCAN Control Register 1 (CANCTL1)”).</p> <p>The following registers enter their hard reset state and restore their default values: CANCTL0⁸, CANRFLG⁹, CANRIER¹⁰, CANTFLG, CANTIER, CANTARQ, CANTAACK, and CANTBSEL.</p> <p>The registers CANCTL1, CANBTR0, CANBTR1, CANIDAC, CANIDAR0-7, and CANIDMR0-7 can only be written by the CPU when the MSCAN is in initialization mode (INITRQ = 1 and INITAK = 1). The values of the error counters are not affected by initialization mode.</p> <p>When this bit is cleared by the CPU, the MSCAN restarts and then tries to synchronize to the CAN bus. If the MSCAN is not in bus-off state, it synchronizes after 11 consecutive recessive bits on the CAN bus; if the MSCAN is in bus-off state, it continues to wait for 128 occurrences of 11 consecutive recessive bits.</p> <p>Writing to other bits in CANCTL0, CANRFLG, CANRIER, CANTFLG, or CANTIER must be done only after initialization mode is exited, which is INITRQ = 0 and INITAK = 0.</p> <p>0 Normal operation 1 MSCAN in initialization mode</p>

¹ The MSCAN must be in normal mode for this bit to become set.

² See the Bosch CAN 2.0A/B specification for a detailed definition of transmitter and receiver states.

³ In order to protect from accidentally violating the CAN protocol, the TXCAN pin is immediately forced to a recessive state when the CPU enters wait (CSWAI = 1) or stop mode (see Section 12.5.5.2, “Operation in Wait Mode” and Section 12.5.5.3, “Operation in Stop Mode”).

⁴ The CPU has to make sure that the WUPE bit and the WUPIE wake-up interrupt enable bit (see Section 12.3.5, “MSCAN Receiver Interrupt Enable Register (CANRIER)”) is enabled, if the recovery mechanism from stop or wait is required.

⁵ The CPU cannot clear SLPRQ before the MSCAN has entered sleep mode (SLPRQ = 1 and SLPK = 1).

⁶ The CPU cannot clear INITRQ before the MSCAN has entered initialization mode (INITRQ = 1 and INITAK = 1).

⁷ In order to protect from accidentally violating the CAN protocol, the TXCAN pin is immediately forced to a recessive state when the initialization mode is requested by the CPU. Thus, the recommended procedure is to bring the MSCAN into sleep mode (SLPRQ = 1 and SLPK = 1) before requesting initialization mode.

⁸ Not including WUPE, INITRQ, and SLPRQ.

⁹ TSTAT1 and TSTAT0 are not affected by initialization mode.

¹⁰ RSTAT1 and RSTAT0 are not affected by initialization mode.

12.3.2 MSCAN Control Register 1 (CANCTL1)

The CANCTL1 register provides various control bits and handshake status information of the MSCAN module as described below.

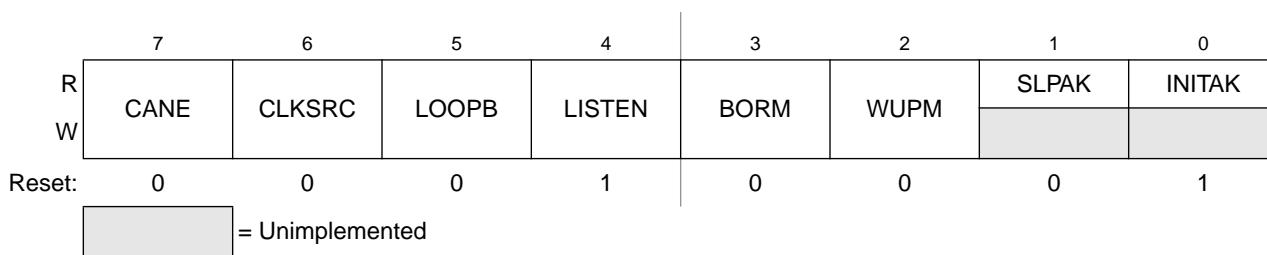

Figure 12-5. MSCAN Control Register 1(CANCTL1)

Read: Anytime

Write: Anytime when INITRQ = 1 and INITAK = 1, except CANE which is write once in normal and anytime in special system operation modes when the MSCAN is in initialization mode (INITRQ = 1 and INITAK = 1).

Table 12-2. CANCTL1 Register Field Descriptions

Field	Description
7 CANE	MSCAN Enable 0 MSCAN module is disabled 1 MSCAN module is enabled
6 CLKSRC	MSCAN Clock Source — This bit defines the clock source for the MSCAN module (only for systems with a clock generation module; Section 12.5.3.3, “Clock System,” and Section Figure 12-42., “MSCAN Clocking Scheme.”) 0 MSCAN clock source is the oscillator clock 1 MSCAN clock source is the bus clock
5 LOOPB	Loopback Self Test Mode — When this bit is set, the MSCAN performs an internal loopback which can be used for self test operation. The bit stream output of the transmitter is fed back to the receiver internally. Section 12.5.4.6, “Loopback Self Test Mode.” 0 Loopback self test disabled 1 Loopback self test enabled
4 LISTEN	Listen Only Mode — This bit configures the MSCAN as a CAN bus monitor. When LISTEN is set, all valid CAN messages with matching ID are received, but no acknowledgement or error frames are sent out (see Section 12.5.4.4, “Listen-Only Mode”). In addition, the error counters are frozen. Listen only mode supports applications which require “hot plugging” or throughput analysis. The MSCAN is unable to transmit any messages when listen only mode is active. 0 Normal operation 1 Listen only mode activated
3 BORM	Bus-Off Recovery Mode — This bits configures the bus-off state recovery mode of the MSCAN. Refer to Section 12.6.2, “Bus-Off Recovery,” for details. 0 Automatic bus-off recovery (see Bosch CAN 2.0A/B protocol specification) 1 Bus-off recovery upon user request
2 WUPM	Wake-Up Mode — If WUPE in CANCTL0 is enabled, this bit defines whether the integrated low-pass filter is applied to protect the MSCAN from spurious wake-up (see Section 12.5.5.4, “MSCAN Sleep Mode”). 0 MSCAN wakes up on any dominant level on the CAN bus 1 MSCAN wakes up only in case of a dominant pulse on the CAN bus that has a length of T_{wup}

Table 12-2. CANCTL1 Register Field Descriptions (continued)

Field	Description
1 SLPAK	<p>Sleep Mode Acknowledge — This flag indicates whether the MSCAN module has entered sleep mode (see Section 12.5.5.4, “MSCAN Sleep Mode”). It is used as a handshake flag for the SLPRQ sleep mode request. Sleep mode is active when SLPRQ = 1 and SLPAK = 1. Depending on the setting of WUPE, the MSCAN will clear the flag if it detects activity on the CAN bus while in sleep mode. CPU clearing the SLPRQ bit will also reset the SLPAK bit.</p> <p>0 Running — The MSCAN operates normally 1 Sleep mode active — The MSCAN has entered sleep mode</p>
0 INITAK	<p>Initialization Mode Acknowledge — This flag indicates whether the MSCAN module is in initialization mode (see Section 12.5.5.5, “MSCAN Initialization Mode”). It is used as a handshake flag for the INITRQ initialization mode request. Initialization mode is active when INITRQ = 1 and INITAK = 1. The registers CANCTL1, CANBTR0, CANBTR1, CANIDAC, CANIDAR0–CANIDAR7, and CANIDMR0–CANIDMR7 can be written only by the CPU when the MSCAN is in initialization mode.</p> <p>0 Running — The MSCAN operates normally 1 Initialization mode active — The MSCAN is in initialization mode</p>

12.3.3 MSCAN Bus Timing Register 0 (CANBTR0)

The CANBTR0 register configures various CAN bus timing parameters of the MSCAN module.

	7	6	5	4	3	2	1	0
R								
W								
Reset:	0	0	0	0	0	0	0	0

Figure 12-6. MSCAN Bus Timing Register 0 (CANBTR0)

Read: Anytime

Write: Anytime in initialization mode (INITRQ = 1 and INITAK = 1)

Table 12-3. CANBTR0 Register Field Descriptions

Field	Description
7:6 SJW[1:0]	<p>Synchronization Jump Width — The synchronization jump width defines the maximum number of time quanta (Tq) clock cycles a bit can be shortened or lengthened to achieve resynchronization to data transitions on the CAN bus (see Table 12-4).</p>
5:0 BRP[5:0]	<p>Baud Rate Prescaler — These bits determine the time quanta (Tq) clock which is used to build up the bit timing (see Table 12-5).</p>

Table 12-4. Synchronization Jump Width

SJW1	SJW0	Synchronization Jump Width
0	0	1 Tq clock cycle
0	1	2 Tq clock cycles
1	0	3 Tq clock cycles
1	1	4 Tq clock cycles

Table 12-5. Baud Rate Prescaler

BRP5	BRP4	BRP3	BRP2	BRP1	BRP0	Prescaler value (P)
0	0	0	0	0	0	1
0	0	0	0	0	1	2
0	0	0	0	1	0	3
0	0	0	0	1	1	4
:	:	:	:	:	:	:
1	1	1	1	1	1	64

12.3.4 MSCAN Bus Timing Register 1 (CANBTR1)

The CANBTR1 register configures various CAN bus timing parameters of the MSCAN module.

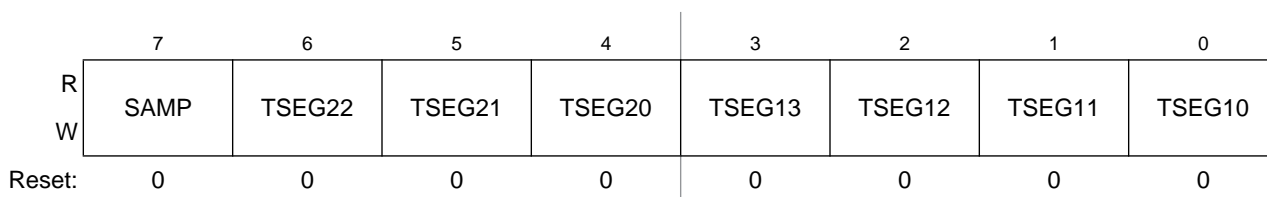

Figure 12-7. MSCAN Bus Timing Register 1 (CANBTR1)

Read: Anytime

Write: Anytime in initialization mode (INITRQ = 1 and INITAK = 1)

Table 12-6. CANBTR1 Register Field Descriptions

Field	Description
7 SAMP	Sampling — This bit determines the number of CAN bus samples taken per bit time. 0 One sample per bit. 1 Three samples per bit ¹ . If SAMP = 0, the resulting bit value is equal to the value of the single bit positioned at the sample point. If SAMP = 1, the resulting bit value is determined by using majority rule on the three total samples. For higher bit rates, it is recommended that only one sample is taken per bit time (SAMP = 0).
6:4 TSEG2[2:0]	Time Segment 2 — Time segments within the bit time fix the number of clock cycles per bit time and the location of the sample point (see Figure 12-43). Time segment 2 (TSEG2) values are programmable as shown in Table 12-7 .
3:0 TSEG1[3:0]	Time Segment 1 — Time segments within the bit time fix the number of clock cycles per bit time and the location of the sample point (see Figure 12-43). Time segment 1 (TSEG1) values are programmable as shown in Table 12-8 .

¹ In this case, PHASE_SEG1 must be at least 2 time quanta (Tq).

Table 12-7. Time Segment 2 Values

TSEG22	TSEG21	TSEG20	Time Segment 2
0	0	0	1 Tq clock cycle ¹
0	0	1	2 Tq clock cycles
:	:	:	:
1	1	0	7 Tq clock cycles
1	1	1	8 Tq clock cycles

¹ This setting is not valid. Please refer to [Table 12-35](#) for valid settings.

Table 12-8. Time Segment 1 Values

TSEG13	TSEG12	TSEG11	TSEG10	Time segment 1
0	0	0	0	1 Tq clock cycle ¹
0	0	0	1	2 Tq clock cycles ¹
0	0	1	0	3 Tq clock cycles ¹
0	0	1	1	4 Tq clock cycles
:	:	:	:	:
1	1	1	0	15 Tq clock cycles
1	1	1	1	16 Tq clock cycles

¹ This setting is not valid. Please refer to [Table 12-35](#) for valid settings.

The bit time is determined by the oscillator frequency, the baud rate prescaler, and the number of time quanta (Tq) clock cycles per bit (as shown in [Table 12-7](#) and [Table 12-8](#)).

Eqn. 12-1

$$\text{Bit Time} = \frac{(\text{Prescaler value})}{f_{\text{CANCLK}}} \cdot (1 + \text{TimeSegment1} + \text{TimeSegment2})$$

12.3.4.1 MSCAN Receiver Flag Register (CANRFLG)

A flag can be cleared only by software (writing a 1 to the corresponding bit position) when the condition which caused the setting is no longer valid. Every flag has an associated interrupt enable bit in the CANRIER register.

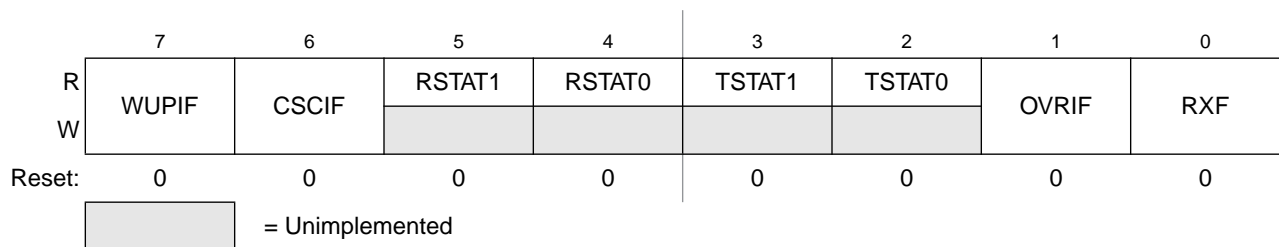
Figure 12-8. MSCAN Receiver Flag Register (CANRFLG)

NOTE

The CANRFLG register is held in the reset state¹ when the initialization mode is active (INITRQ = 1 and INITAK = 1). This register is writable again as soon as the initialization mode is exited (INITRQ = 0 and INITAK = 0).

Read: Anytime

Write: Anytime when out of initialization mode, except RSTAT[1:0] and TSTAT[1:0] flags which are read-only; write of 1 clears flag; write of 0 is ignored.

Table 12-9. CANRFLG Register Field Descriptions

Field	Description
7 WUPIF	Wake-Up Interrupt Flag — If the MSCAN detects CAN bus activity while in sleep mode (see Section 12.5.5.4, “MSCAN Sleep Mode,”) and WUPE = 1 in CANTCTL0 (see Section 12.3.1, “MSCAN Control Register 0 (CANCTL0)”), the module will set WUPIF. If not masked, a wake-up interrupt is pending while this flag is set. 0 No wake-up activity observed while in sleep mode 1 MSCAN detected activity on the CAN bus and requested wake-up
6 CSCIF	CAN Status Change Interrupt Flag — This flag is set when the MSCAN changes its current CAN bus status due to the actual value of the transmit error counter (TEC) and the receive error counter (REC). An additional 4-bit (RSTAT[1:0], TSTAT[1:0]) status register, which is split into separate sections for TEC/REC, informs the system on the actual CAN bus status (see Section 12.3.5, “MSCAN Receiver Interrupt Enable Register (CANRIER)”). If not masked, an error interrupt is pending while this flag is set. CSCIF provides a blocking interrupt. That guarantees that the receiver/transmitter status bits (RSTAT/TSTAT) are only updated when no CAN status change interrupt is pending. If the TECs/RECs change their current value after the CSCIF is asserted, which would cause an additional state change in the RSTAT/TSTAT bits, these bits keep their status until the current CSCIF interrupt is cleared again. 0 No change in CAN bus status occurred since last interrupt 1 MSCAN changed current CAN bus status
5:4 RSTAT[1:0]	Receiver Status Bits — The values of the error counters control the actual CAN bus status of the MSCAN. As soon as the status change interrupt flag (CSCIF) is set, these bits indicate the appropriate receiver related CAN bus status of the MSCAN. The coding for the bits RSTAT1, RSTAT0 is: 00 RxOK: 0 ≤ receive error counter ≤ 96 01 RxWRN: 96 < receive error counter ≤ 127 10 RxERR: 127 < receive error counter 11 Bus-off ¹ : transmit error counter > 255
3:2 TSTAT[1:0]	Transmitter Status Bits — The values of the error counters control the actual CAN bus status of the MSCAN. As soon as the status change interrupt flag (CSCIF) is set, these bits indicate the appropriate transmitter related CAN bus status of the MSCAN. The coding for the bits TSTAT1, TSTAT0 is: 00 TxOK: 0 ≤ transmit error counter ≤ 96 01 TxWRN: 96 < transmit error counter ≤ 127 10 TxERR: 127 < transmit error counter ≤ 255 11 Bus-Off: transmit error counter > 255

1. The RSTAT[1:0], TSTAT[1:0] bits are not affected by initialization mode.

Table 12-9. CANRFLG Register Field Descriptions (continued)

Field	Description
1 OVRIF	Overrun Interrupt Flag — This flag is set when a data overrun condition occurs. If not masked, an error interrupt is pending while this flag is set. 0 No data overrun condition 1 A data overrun detected
0 RXF ²	Receive Buffer Full Flag — RXF is set by the MSCAN when a new message is shifted in the receiver FIFO. This flag indicates whether the shifted buffer is loaded with a correctly received message (matching identifier, matching cyclic redundancy code (CRC) and no other errors detected). After the CPU has read that message from the RxFG buffer in the receiver FIFO, the RXF flag must be cleared to release the buffer. A set RXF flag prohibits the shifting of the next FIFO entry into the foreground buffer (RxFG). If not masked, a receive interrupt is pending while this flag is set. 0 No new message available within the RxFG 1 The receiver FIFO is not empty. A new message is available in the RxFG

¹ Redundant Information for the most critical CAN bus status which is “bus-off”. This only occurs if the Tx error counter exceeds a number of 255 errors. Bus-off affects the receiver state. As soon as the transmitter leaves its bus-off state the receiver state skips to RxOK too. Refer also to TSTAT[1:0] coding in this register.

² To ensure data integrity, do not read the receive buffer registers while the RXF flag is cleared. For MCUs with dual CPUs, reading the receive buffer registers while the RXF flag is cleared may result in a CPU fault condition.

12.3.5 MSCAN Receiver Interrupt Enable Register (CANRIER)

This register contains the interrupt enable bits for the interrupt flags described in the CANRFLG register.

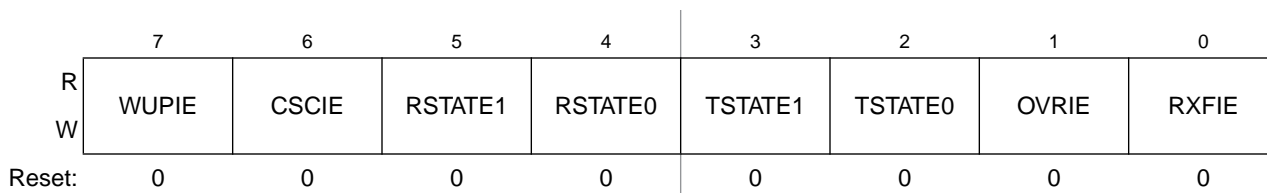
Figure 12-9. MSCAN Receiver Interrupt Enable Register (CANRIER)

NOTE

The CANRIER register is held in the reset state when the initialization mode is active (INTRQ=1 and INITAK=1). This register is writable when not in initialization mode (INTRQ=0 and INITAK=0).

The RSTATE[1:0], TSTATE[1:0] bits are not affected by initialization mode.

Read: Anytime

Write: Anytime when not in initialization mode

Table 12-10. CANRIER Register Field Descriptions

Field	Description
7 WUPIE ¹	Wake-Up Interrupt Enable 0 No interrupt request is generated from this event. 1 A wake-up event causes a Wake-Up interrupt request.
6 CSCIE	CAN Status Change Interrupt Enable 0 No interrupt request is generated from this event. 1 A CAN Status Change event causes an error interrupt request.
5:4 RSTATE[1:0]	Receiver Status Change Enable — These RSTAT enable bits control the sensitivity level in which receiver state changes are causing CSCIF interrupts. Independent of the chosen sensitivity level the RSTAT flags continue to indicate the actual receiver state and are only updated if no CSCIF interrupt is pending. 00 Do not generate any CSCIF interrupt caused by receiver state changes. 01 Generate CSCIF interrupt only if the receiver enters or leaves “bus-off” state. Discard other receiver state changes for generating CSCIF interrupt. 10 Generate CSCIF interrupt only if the receiver enters or leaves “RxErr” or “bus-off” ² state. Discard other receiver state changes for generating CSCIF interrupt. 11 Generate CSCIF interrupt on all state changes.
3:2 TSTATE[1:0]	Transmitter Status Change Enable — These TSTAT enable bits control the sensitivity level in which transmitter state changes are causing CSCIF interrupts. Independent of the chosen sensitivity level, the TSTAT flags continue to indicate the actual transmitter state and are only updated if no CSCIF interrupt is pending. 00 Do not generate any CSCIF interrupt caused by transmitter state changes. 01 Generate CSCIF interrupt only if the transmitter enters or leaves “bus-off” state. Discard other transmitter state changes for generating CSCIF interrupt. 10 Generate CSCIF interrupt only if the transmitter enters or leaves “TxErr” or “bus-off” state. Discard other transmitter state changes for generating CSCIF interrupt. 11 Generate CSCIF interrupt on all state changes.
1 OVRIE	Overrun Interrupt Enable 0 No interrupt request is generated from this event. 1 An overrun event causes an error interrupt request.
0 RXFIE	Receiver Full Interrupt Enable 0 No interrupt request is generated from this event. 1 A receive buffer full (successful message reception) event causes a receiver interrupt request.

¹ WUPIE and WUPE (see Section 12.3.1, “MSCAN Control Register 0 (CANCTL0)”) must both be enabled if the recovery mechanism from stop or wait is required.

² Bus-off state is defined by the CAN standard (see Bosch CAN 2.0A/B protocol specification: for only transmitters. Because the only possible state change for the transmitter from bus-off to TxOK also forces the receiver to skip its current state to RxOK, the coding of the RXSTAT[1:0] flags define an additional bus-off state for the receiver (see Section 12.3.4.1, “MSCAN Receiver Flag Register (CANRFLG)”).

12.3.6 MSCAN Transmitter Flag Register (CANTFLG)

The transmit buffer empty flags each have an associated interrupt enable bit in the CANTIER register.

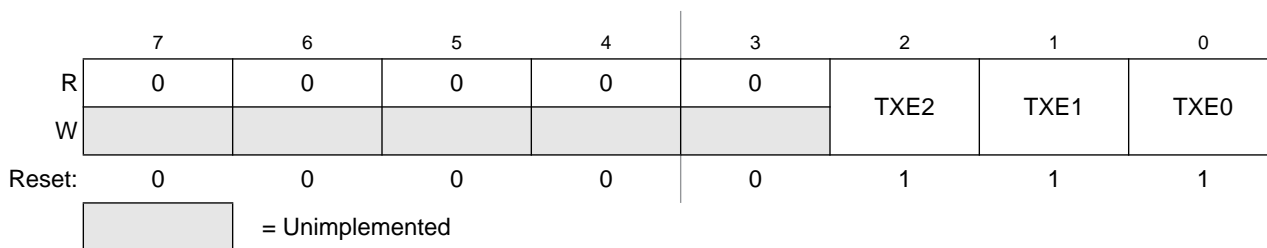

Figure 12-10. MSCAN Transmitter Flag Register (CANTFLG)

NOTE

The CANTFLG register is held in the reset state when the initialization mode is active (INITRQ = 1 and INITAK = 1). This register is writable when not in initialization mode (INITRQ = 0 and INITAK = 0).

Read: Anytime

Write: Anytime for TXE_x flags when not in initialization mode; write of 1 clears flag, write of 0 is ignored

Table 12-11. CANTFLG Register Field Descriptions

Field	Description
2:0 TXE[2:0]	<p>Transmitter Buffer Empty — This flag indicates that the associated transmit message buffer is empty, and thus not scheduled for transmission. The CPU must clear the flag after a message is set up in the transmit buffer and is due for transmission. The MSCAN sets the flag after the message is sent successfully. The flag is also set by the MSCAN when the transmission request is successfully aborted due to a pending abort request (see Section 12.3.8, “MSCAN Transmitter Message Abort Request Register (CANTARQ)”). If not masked, a transmit interrupt is pending while this flag is set.</p> <p>Clearing a TXE_x flag also clears the corresponding ABTAK_x (see Section 12.3.9, “MSCAN Transmitter Message Abort Acknowledge Register (CANTAACK)”). When a TXE_x flag is set, the corresponding ABTRQ_x bit is cleared (see Section 12.3.8, “MSCAN Transmitter Message Abort Request Register (CANTARQ)”).</p> <p>When listen-mode is active (see Section 12.3.2, “MSCAN Control Register 1 (CANCTL1)”) the TXE_x flags cannot be cleared and no transmission is started.</p> <p>Read and write accesses to the transmit buffer are blocked, if the corresponding TXE_x bit is cleared (TXE_x = 0) and the buffer is scheduled for transmission.</p> <p>0 The associated message buffer is full (loaded with a message due for transmission) 1 The associated message buffer is empty (not scheduled)</p>

12.3.7 MSCAN Transmitter Interrupt Enable Register (CANTIER)

This register contains the interrupt enable bits for the transmit buffer empty interrupt flags.

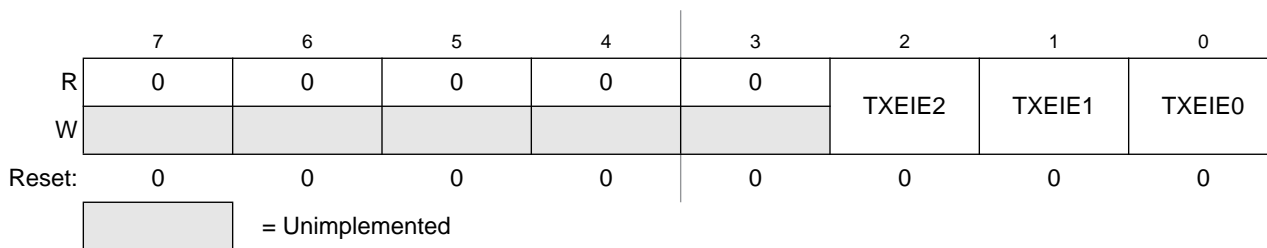

Figure 12-11. MSCAN Transmitter Interrupt Enable Register (CANTIER)

NOTE

The CANTIER register is held in the reset state when the initialization mode is active (INITRQ = 1 and INITAK = 1). This register is writable when not in initialization mode (INITRQ = 0 and INITAK = 0).

Read: Anytime

Write: Anytime when not in initialization mode

Table 12-12. CANTIER Register Field Descriptions

Field	Description
2:0 TXEIE[2:0]	<p>Transmitter Empty Interrupt Enable</p> <p>0 No interrupt request is generated from this event.</p> <p>1 A transmitter empty (transmit buffer available for transmission) event causes a transmitter empty interrupt request. See Section 12.5.2.2, "Transmit Structures" for details.</p>

12.3.8 MSCAN Transmitter Message Abort Request Register (CANTARQ)

The CANTARQ register allows abort request of messages queued for transmission.

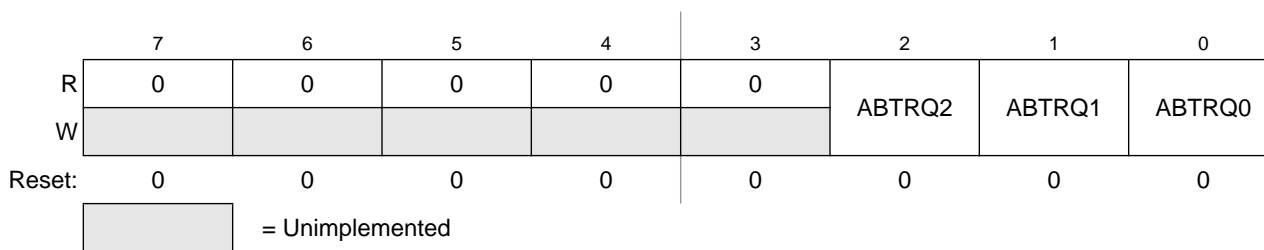

Figure 12-12. MSCAN Transmitter Message Abort Request Register (CANTARQ)

NOTE

The CANTARQ register is held in the reset state when the initialization mode is active (INITRQ = 1 and INITAK = 1). This register is writable when not in initialization mode (INITRQ = 0 and INITAK = 0).

Read: Anytime

Write: Anytime when not in initialization mode

Table 12-13. CANTARQ Register Field Descriptions

Field	Description
2:0 ABTRQ[2:0]	<p>Abort Request — The CPU sets the ABTRQx bit to request that a scheduled message buffer (TXEx = 0) be aborted. The MSCAN grants the request if the message has not already started transmission, or if the transmission is not successful (lost arbitration or error). When a message is aborted, the associated TXE (see Section 12.3.6, "MSCAN Transmitter Flag Register (CANTFLG)") and abort acknowledge flags (ABTAK, see Section 12.3.9, "MSCAN Transmitter Message Abort Acknowledge Register (CANTAACK)") are set and a transmit interrupt occurs if enabled. The CPU cannot reset ABTRQx. ABTRQx is reset whenever the associated TXE flag is set.</p> <p>0 No abort request</p> <p>1 Abort request pending</p>

12.3.9 MSCAN Transmitter Message Abort Acknowledge Register (CANTAACK)

The CANTAACK register indicates the successful abort of messages queued for transmission, if requested by the appropriate bits in the CANTARQ register.

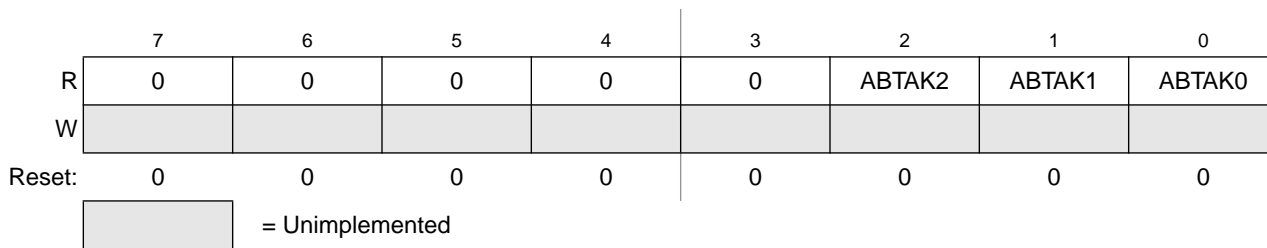

Figure 12-13. MSCAN Transmitter Message Abort Acknowledge Register (CANTAACK)

NOTE

The CANTAACK register is held in the reset state when the initialization mode is active (INTRQ = 1 and INITAK = 1).

Read: Anytime

Write: Unimplemented for ABTAKx flags

Table 12-14. CANTAACK Register Field Descriptions

Field	Description
2:0 ABTAK[2:0]	<p>Abort Acknowledge — This flag acknowledges that a message was aborted due to a pending transmission abort request from the CPU. After a particular message buffer is flagged empty, this flag can be used by the application software to identify whether the message was aborted successfully or was sent anyway. The ABTAKx flag is cleared whenever the corresponding TXE flag is cleared.</p> <p>0 The message was not aborted. 1 The message was aborted.</p>

12.3.10 MSCAN Transmit Buffer Selection Register (CANTBSEL)

The CANTBSEL selections of the actual transmit message buffer, which is accessible in the CANTXFG register space.

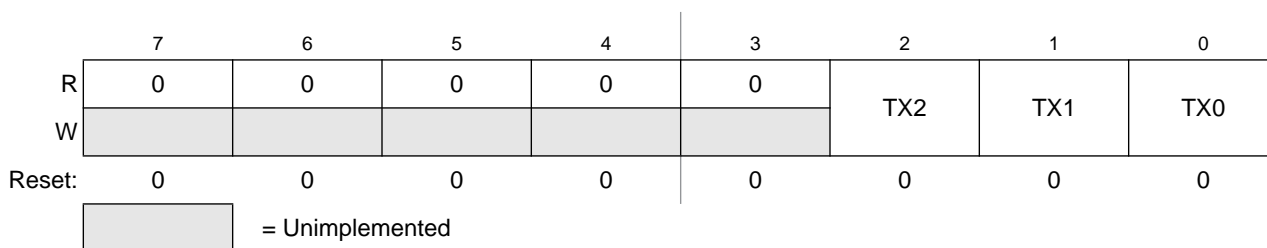

Figure 12-14. MSCAN Transmit Buffer Selection Register (CANTBSEL)

NOTE

The CANTBSEL register is held in the reset state when the initialization mode is active (INITRQ = 1 and INITAK=1). This register is writable when not in initialization mode (INITRQ = 0 and INITAK = 0).

Read: Find the lowest ordered bit set to 1, all other bits will be read as 0

Write: Anytime when not in initialization mode

Table 12-15. CANTBSEL Register Field Descriptions

Field	Description
2:0 TX[2:0]	<p>Transmit Buffer Select — The lowest numbered bit places the respective transmit buffer in the CANTXFG register space (e.g., TX1 = 1 and TX0 = 1 selects transmit buffer TX0; TX1 = 1 and TX0 = 0 selects transmit buffer TX1). Read and write accesses to the selected transmit buffer will be blocked, if the corresponding TXEx bit is cleared and the buffer is scheduled for transmission (see Section 12.3.6, “MSCAN Transmitter Flag Register (CANTFLG)”).</p> <p>0 The associated message buffer is deselected 1 The associated message buffer is selected, if lowest numbered bit</p>

The following gives a short programming example of the usage of the CANTBSEL register:

To get the next available transmit buffer, application software must read the CANTFLG register and write this value back into the CANTBSEL register. In this example Tx buffers TX1 and TX2 are available. The value read from CANTFLG is therefore 0b0000_0110. When writing this value back to CANTBSEL, the Tx buffer TX1 is selected in the CANTXFG because the lowest numbered bit set to 1 is at bit position 1. Reading back this value out of CANTBSEL results in 0b0000_0010, because only the lowest numbered bit position set to 1 is presented. This mechanism eases the application software the selection of the next available Tx buffer.

- LDD CANTFLG; value read is 0b0000_0110
- STD CANTBSEL; value written is 0b0000_0110
- LDD CANTBSEL; value read is 0b0000_0010

If all transmit message buffers are deselected, no accesses are allowed to the CANTXFG buffer register.

12.3.11 MSCAN Identifier Acceptance Control Register (CANIDAC)

The CANIDAC register is used for identifier filter acceptance control as described below.

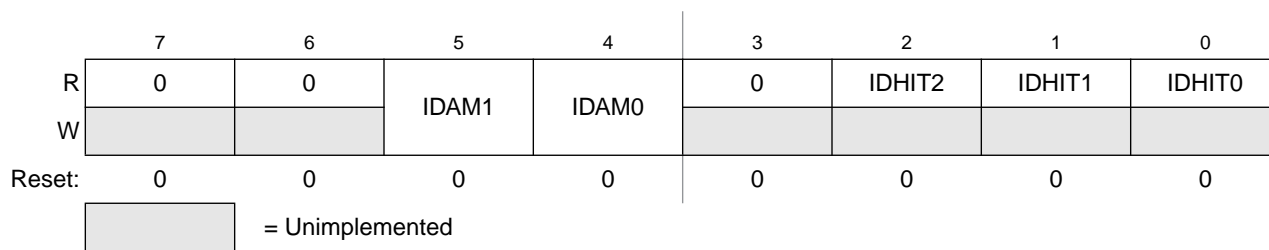

Figure 12-15. MSCAN Identifier Acceptance Control Register (CANIDAC)

Read: Anytime

Write: Anytime in initialization mode (INTRQ = 1 and INITAK = 1), except bits IDHITx, which are read-only

Table 12-16. CANIDAC Register Field Descriptions

Field	Description
5:4 IDAM[1:0]	Identifier Acceptance Mode — The CPU sets these flags to define the identifier acceptance filter organization (see Section 12.5.3, "Identifier Acceptance Filter"). Table 12-17 summarizes the different settings. In filter closed mode, no message is accepted such that the foreground buffer is never reloaded.
2:0 IDHIT[2:0]	Identifier Acceptance Hit Indicator — The MSCAN sets these flags to indicate an identifier acceptance hit (see Section 12.5.3, "Identifier Acceptance Filter"). Table 12-18 summarizes the different settings.

Table 12-17. Identifier Acceptance Mode Settings

IDAM1	IDAM0	Identifier Acceptance Mode
0	0	Two 32-bit acceptance filters
0	1	Four 16-bit acceptance filters
1	0	Eight 8-bit acceptance filters
1	1	Filter closed

Table 12-18. Identifier Acceptance Hit Indication

IDHIT2	IDHIT1	IDHIT0	Identifier Acceptance Hit
0	0	0	Filter 0 hit
0	0	1	Filter 1 hit
0	1	0	Filter 2 hit
0	1	1	Filter 3 hit
1	0	0	Filter 4 hit
1	0	1	Filter 5 hit
1	1	0	Filter 6 hit
1	1	1	Filter 7 hit

The IDHITx indicators are always related to the message in the foreground buffer (RxFG). When a message gets shifted into the foreground buffer of the receiver FIFO the indicators are updated as well.

12.3.12 MSCAN Miscellaneous Register (CANMISC)

This register provides additional features.

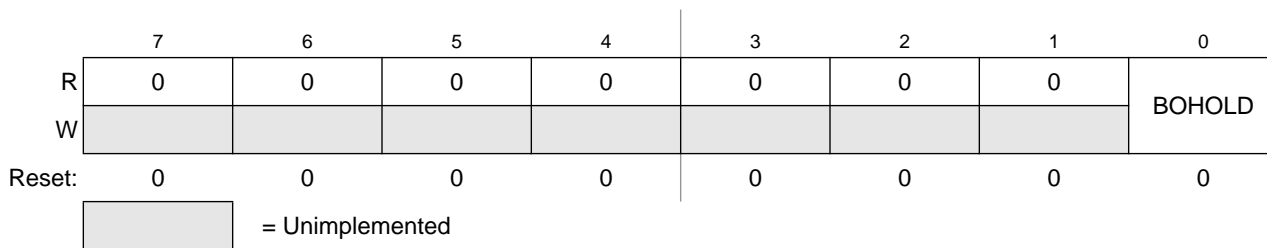

Figure 12-16. MSCAN Miscellaneous Register (CANMISC)

Read: Anytime

Write: Anytime; write of '1' clears flag; write of '0' ignored

Table 12-19. CANMISC Register Field Descriptions

Field	Description
0 BOHOLD	Bus-off State Hold Until User Request — If BORM is set in Section 12.3.2, “MSCAN Control Register 1 (CANCTL1)” , this bit indicates whether the module has entered the bus-off state. Clearing this bit requests the recovery from bus-off. Refer to Section 12.6.2, “Bus-Off Recovery,” for details. 0 Module is not bus-off or recovery has been requested by user in bus-off state 1 Module is bus-off and holds this state until user request

12.3.13 MSCAN Receive Error Counter (CANRXERR)

This register reflects the status of the MSCAN receive error counter.



Figure 12-17. MSCAN Receive Error Counter (CANRXERR)

Read: Only when in sleep mode (SLPRQ = 1 and SLPK = 1) or initialization mode (INITRQ = 1 and INITAK = 1)

Write: Unimplemented

NOTE

Reading this register when in any other mode other than sleep or initialization mode may return an incorrect value. For MCUs with dual CPUs, this may result in a CPU fault condition.

Writing to this register when in special modes can alter the MSCAN functionality.

12.3.14 MSCAN Transmit Error Counter (CANTXERR)

This register reflects the status of the MSCAN transmit error counter.

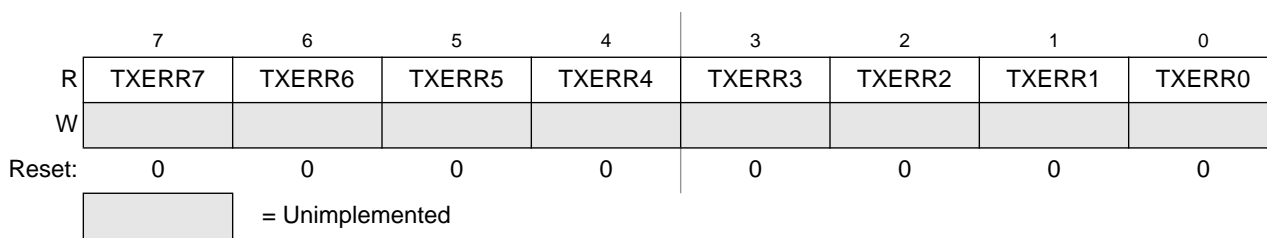

Figure 12-18. MSCAN Transmit Error Counter (CANTXERR)

Read: Only when in sleep mode (SLPRQ = 1 and SLPK = 1) or initialization mode (INITRQ = 1 and INITAK = 1)

Write: Unimplemented

NOTE

Reading this register when in any other mode other than sleep or initialization mode, may return an incorrect value. For MCUs with dual CPUs, this may result in a CPU fault condition.

Writing to this register when in special modes can alter the MSCAN functionality.

12.3.15 MSCAN Identifier Acceptance Registers (CANIDAR0-7)

On reception, each message is written into the background receive buffer. The CPU is only signalled to read the message if it passes the criteria in the identifier acceptance and identifier mask registers (accepted); otherwise, the message is overwritten by the next message (dropped).

The acceptance registers of the MSCAN are applied on the IDR0–IDR3 registers (see [Section 12.4.1, “Identifier Registers \(IDR0–IDR3\)”](#)) of incoming messages in a bit by bit manner (see [Section 12.5.3, “Identifier Acceptance Filter”](#)).

For extended identifiers, all four acceptance and mask registers are applied. For standard identifiers, only the first two (CANIDAR0/1, CANIDMR0/1) are applied.

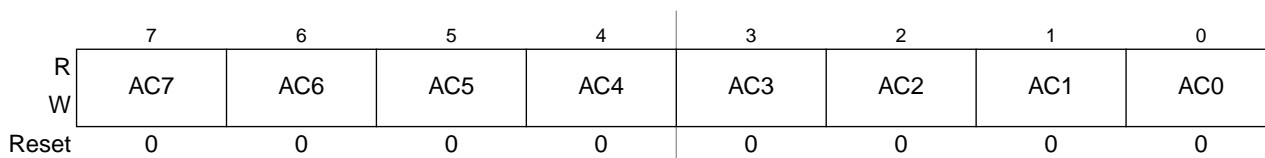

Figure 12-19. MSCAN Identifier Acceptance Registers (First Bank) — CANIDAR0–CANIDAR3

Read: Anytime

Write: Anytime in initialization mode (INITRQ = 1 and INITAK = 1)

Table 12-20. CANIDAR0–CANIDAR3 Register Field Descriptions

Field	Description
7:0 AC[7:0]	Acceptance Code Bits — AC[7:0] comprise a user-defined sequence of bits with which the corresponding bits of the related identifier register (IDRn) of the receive message buffer are compared. The result of this comparison is then masked with the corresponding identifier mask register.

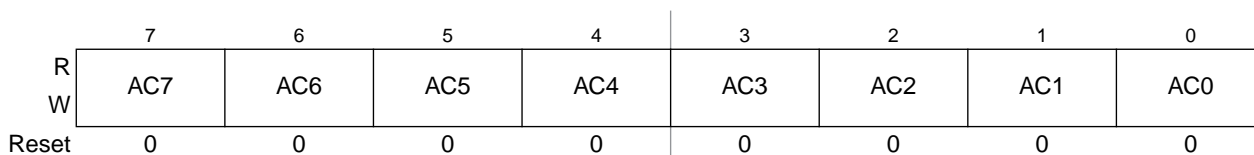

Figure 12-20. MSCAN Identifier Acceptance Registers (Second Bank) — CANIDAR4–CANIDAR7

Read: Anytime

Write: Anytime in initialization mode (INITRQ = 1 and INITAK = 1)

Table 12-21. CANIDAR4–CANIDAR7 Register Field Descriptions

Field	Description
7:0 AC[7:0]	Acceptance Code Bits — AC[7:0] comprise a user-defined sequence of bits with which the corresponding bits of the related identifier register (IDRn) of the receive message buffer are compared. The result of this comparison is then masked with the corresponding identifier mask register.

12.3.16 MSCAN Identifier Mask Registers (CANIDMR0–CANIDMR7)

The identifier mask register specifies which of the corresponding bits in the identifier acceptance register are relevant for acceptance filtering. To receive standard identifiers in 32 bit filter mode, it is required to program the last three bits (AM[2:0]) in the mask registers CANIDMR1 and CANIDMR5 to “don’t care.” To receive standard identifiers in 16 bit filter mode, it is required to program the last three bits (AM[2:0]) in the mask registers CANIDMR1, CANIDMR3, CANIDMR5, and CANIDMR7 to “don’t care.”

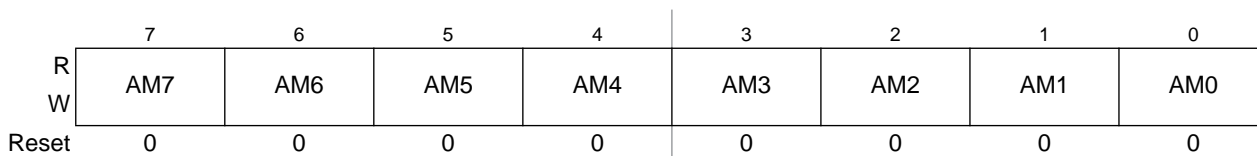

Figure 12-21. MSCAN Identifier Mask Registers (First Bank) — CANIDMR0–CANIDMR3

Read: Anytime

Write: Anytime in initialization mode (INITRQ = 1 and INITAK = 1)

Table 12-22. CANIDMR0–CANIDMR3 Register Field Descriptions

Field	Description
7:0 AM[7:0]	<p>Acceptance Mask Bits — If a particular bit in this register is cleared, this indicates that the corresponding bit in the identifier acceptance register must be the same as its identifier bit before a match is detected. The message is accepted if all such bits match. If a bit is set, it indicates that the state of the corresponding bit in the identifier acceptance register does not affect whether or not the message is accepted.</p> <p>0 Match corresponding acceptance code register and identifier bits 1 Ignore corresponding acceptance code register bit (don't care)</p>

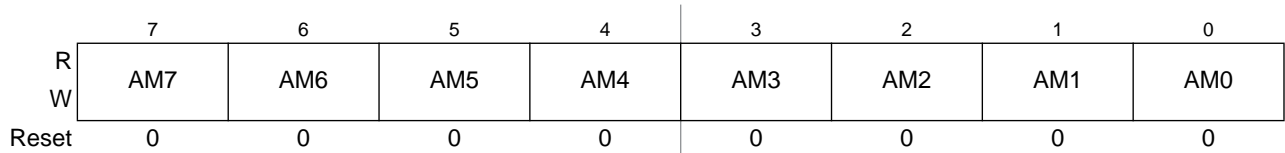
Figure 12-22. MSCAN Identifier Mask Registers (Second Bank) — CANIDMR4–CANIDMR7

Read: Anytime

Write: Anytime in initialization mode (INITRQ = 1 and INITAK = 1)

Table 12-23. CANIDMR4–CANIDMR7 Register Field Descriptions

Field	Description
7:0 AM[7:0]	<p>Acceptance Mask Bits — If a particular bit in this register is cleared, this indicates that the corresponding bit in the identifier acceptance register must be the same as its identifier bit before a match is detected. The message is accepted if all such bits match. If a bit is set, it indicates that the state of the corresponding bit in the identifier acceptance register does not affect whether or not the message is accepted.</p> <p>0 Match corresponding acceptance code register and identifier bits 1 Ignore corresponding acceptance code register bit (don't care)</p>

12.4 Programmer's Model of Message Storage

The following section details the organization of the receive and transmit message buffers and the associated control registers.

To simplify the programmer interface, the receive and transmit message buffers have the same outline. Each message buffer allocates 16 bytes in the memory map containing a 13 byte data structure.

An additional transmit buffer priority register (TBPR) is defined for the transmit buffers. Within the last two bytes of this memory map, the MSCAN stores a special 16-bit time stamp, which is sampled from an internal timer after successful transmission or reception of a message. This feature is only available for transmit and receiver buffers if the TIME bit is set (see [Section 12.3.1, “MSCAN Control Register 0 \(CANCTL0\)”](#)).

The time stamp register is written by the MSCAN. The CPU can only read these registers.

Table 12-24. Message Buffer Organization

Offset Address	Register	Access
0x00X0	Identifier Register 0	
0x00X1	Identifier Register 1	
0x00X2	Identifier Register 2	
0x00X3	Identifier Register 3	
0x00X4	Data Segment Register 0	
0x00X5	Data Segment Register 1	
0x00X6	Data Segment Register 2	
0x00X7	Data Segment Register 3	
0x00X8	Data Segment Register 4	
0x00X9	Data Segment Register 5	
0x00XA	Data Segment Register 6	
0x00XB	Data Segment Register 7	
0x00XC	Data Length Register	
0x00XD	Transmit Buffer Priority Register ¹	
0x00XE	Time Stamp Register (High Byte) ²	
0x00XF	Time Stamp Register (Low Byte) ³	

¹ Not applicable for receive buffers

² Read-only for CPU

³ Read-only for CPU

Figure 12-23 shows the common 13-byte data structure of receive and transmit buffers for extended identifiers. The mapping of standard identifiers into the IDR registers is shown in Figure 12-24.

All bits of the receive and transmit buffers are ‘x’ out of reset because of RAM-based implementation¹. All reserved or unused bits of the receive and transmit buffers always read ‘x’.

1. Exception: The transmit priority registers are 0 out of reset.

Register Name		Bit 7	6	5	4	3	2	1	Bit0
IDR0	R	ID28	ID27	ID26	ID25	ID24	ID23	ID22	ID21
	W								
IDR1	R	ID20	ID19	ID18	SRR ⁽¹⁾	IDE ⁽¹⁾	ID17	ID16	ID15
	W								
IDR2	R	ID14	ID13	ID12	ID11	ID10	ID9	ID8	ID7
	W								
IDR3	R	ID6	ID5	ID4	ID3	ID2	ID1	ID0	RTR ²
	W								
DSR0	R	DB7	DB6	DB5	DB4	DB3	DB2	DB1	DB0
	W								
DSR1	R	DB7	DB6	DB5	DB4	DB3	DB2	DB1	DB0
	W								
DSR2	R	DB7	DB6	DB5	DB4	DB3	DB2	DB1	DB0
	W								
DSR3	R	DB7	DB6	DB5	DB4	DB3	DB2	DB1	DB0
	W								
DSR4	R	DB7	DB6	DB5	DB4	DB3	DB2	DB1	DB0
	W								
DSR5	R	DB7	DB6	DB5	DB4	DB3	DB2	DB1	DB0
	W								
DSR6	R	DB7	DB6	DB5	DB4	DB3	DB2	DB1	DB0
	W								
DSR7	R	DB7	DB6	DB5	DB4	DB3	DB2	DB1	DB0
	W								
DLR	R					DLC3	DLC2	DLC1	DLC0
	W								

 = Unused, always read 'x'

Figure 12-23. Receive/Transmit Message Buffer — Extended Identifier Mapping

¹ SRR and IDE are both 1s.

² The position of RTR differs between extended and standard identifier mapping.

Read: For transmit buffers, anytime when TXEx flag is set (see [Section 12.3.6, “MSCAN Transmitter Flag Register \(CANTFLG\)”](#)) and the corresponding transmit buffer is selected in CANTBSEL (see

Section 12.3.10, “MSCAN Transmit Buffer Selection Register (CANTBSEL)”). For receive buffers, only when RXF flag is set (see Section 12.3.4.1, “MSCAN Receiver Flag Register (CANRFLG)”).

Write: For transmit buffers, anytime when TXEx flag is set (see Section 12.3.6, “MSCAN Transmitter Flag Register (CANTFLG)”) and the corresponding transmit buffer is selected in CANTBSEL (see Section 12.3.10, “MSCAN Transmit Buffer Selection Register (CANTBSEL)”). Unimplemented for receive buffers.

Reset: Undefined (0x00XX) because of RAM-based implementation

Register Name		Bit 7	6	5	4	3	2	1	Bit 0
IDR0	R	ID10	ID9	ID8	ID7	ID6	ID5	ID4	ID3
	W								
IDR1	R	ID2	ID1	ID0	RTR ¹	IDE ²			
	W								
IDR2	R								
	W								
IDR3	R								
	W								

= Unused, always read 'x'

Figure 12-24. Receive/Transmit Message Buffer — Standard Identifier Mapping

¹ The position of RTR differs between extended and standard identifier mapping.

² IDE is 0.

12.4.1 Identifier Registers (IDR0–IDR3)

The identifier registers for an extended format identifier consist of a total of 32 bits; ID[28:0], SRR, IDE, and RTR bits. The identifier registers for a standard format identifier consist of a total of 13 bits; ID[10:0], RTR, and IDE bits.

12.4.1.1 IDR0–IDR3 for Extended Identifier Mapping

	7	6	5	4	3	2	1	0
R	ID28	ID27	ID26	ID25	ID24	ID23	ID22	ID21
W								
Reset:	x	x	x	x	x	x	x	x

Figure 12-25. Identifier Register 0 (IDR0) — Extended Identifier Mapping

Table 12-25. IDR0 Register Field Descriptions — Extended

Field	Description
7:0 ID[28:21]	Extended Format Identifier — The identifiers consist of 29 bits (ID[28:0]) for the extended format. ID28 is the most significant bit and is transmitted first on the CAN bus during the arbitration procedure. The priority of an identifier is defined to be highest for the smallest binary number.

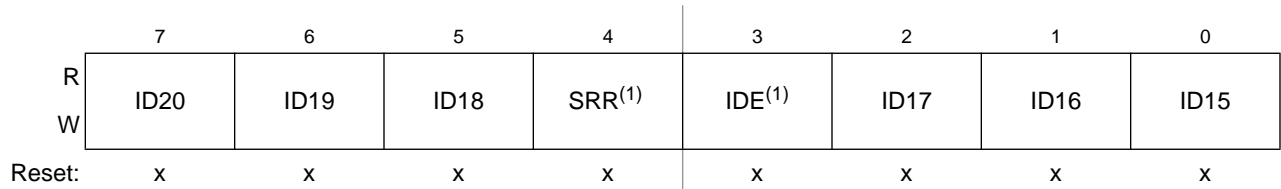
Figure 12-26. Identifier Register 1 (IDR1) — Extended Identifier Mapping

¹ SRR and IDE are both 1s.

Table 12-26. IDR1 Register Field Descriptions — Extended

Field	Description
7:5 ID[20:18]	Extended Format Identifier — The identifiers consist of 29 bits (ID[28:0]) for the extended format. ID28 is the most significant bit and is transmitted first on the CAN bus during the arbitration procedure. The priority of an identifier is defined to be highest for the smallest binary number.
4 SRR	Substitute Remote Request — This fixed recessive bit is used only in extended format. It must be set to 1 by the user for transmission buffers and is stored as received on the CAN bus for receive buffers.
3 IDE	ID Extended — This flag indicates whether the extended or standard identifier format is applied in this buffer. In the case of a receive buffer, the flag is set as received and indicates to the CPU how to process the buffer identifier registers. In the case of a transmit buffer, the flag indicates to the MSCAN what type of identifier to send. 0 Standard format (11 bit) 1 Extended format (29 bit)
2:0 ID[17:15]	Extended Format Identifier — The identifiers consist of 29 bits (ID[28:0]) for the extended format. ID28 is the most significant bit and is transmitted first on the CAN bus during the arbitration procedure. The priority of an identifier is defined to be highest for the smallest binary number.

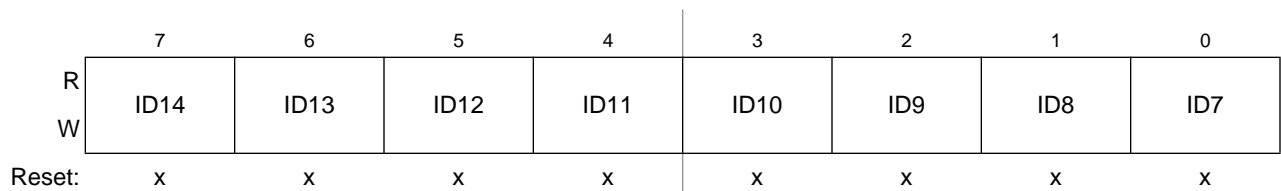
Figure 12-27. Identifier Register 2 (IDR2) — Extended Identifier Mapping
Table 12-27. IDR2 Register Field Descriptions — Extended

Field	Description
7:0 ID[14:7]	Extended Format Identifier — The identifiers consist of 29 bits (ID[28:0]) for the extended format. ID28 is the most significant bit and is transmitted first on the CAN bus during the arbitration procedure. The priority of an identifier is defined to be highest for the smallest binary number.

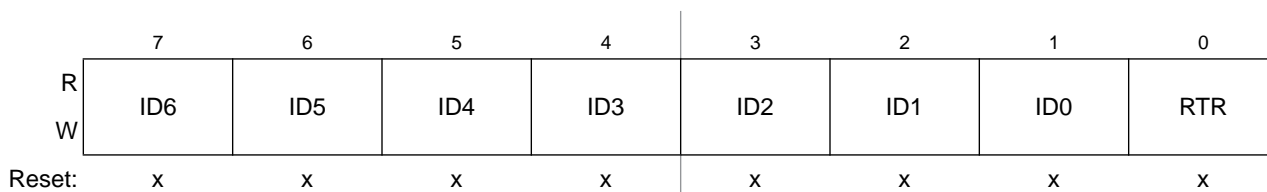

Figure 12-28. Identifier Register 3 (IDR3) — Extended Identifier Mapping

Table 12-28. IDR3 Register Field Descriptions — Extended

Field	Description
7:1 ID[6:0]	Extended Format Identifier — The identifiers consist of 29 bits (ID[28:0]) for the extended format. ID28 is the most significant bit and is transmitted first on the CAN bus during the arbitration procedure. The priority of an identifier is defined to be highest for the smallest binary number.
0 RTR	Remote Transmission Request — This flag reflects the status of the remote transmission request bit in the CAN frame. In the case of a receive buffer, it indicates the status of the received frame and supports the transmission of an answering frame in software. In the case of a transmit buffer, this flag defines the setting of the RTR bit to be sent. 0 Data frame 1 Remote frame

12.4.2 IDR0–IDR3 for Standard Identifier Mapping

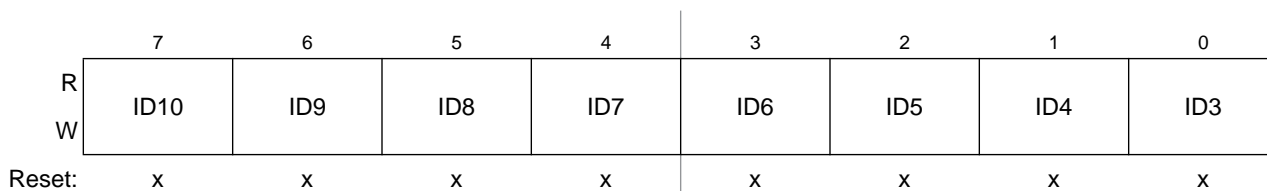
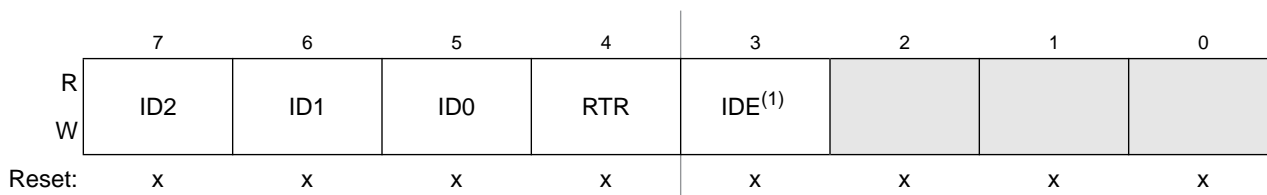

Figure 12-29. Identifier Register 0 — Standard Mapping

Table 12-29. IDR0 Register Field Descriptions — Standard

Field	Description
7:0 ID[10:3]	Standard Format Identifier — The identifiers consist of 11 bits (ID[10:0]) for the standard format. ID10 is the most significant bit and is transmitted first on the CAN bus during the arbitration procedure. The priority of an identifier is defined to be highest for the smallest binary number. See also ID bits in Table 12-30.



= Unused; always read 'x'

Figure 12-30. Identifier Register 1 — Standard Mapping

¹ IDE is 0.

Table 12-30. IDR1 Register Field Descriptions

Field	Description
7:5 ID[2:0]	Standard Format Identifier — The identifiers consist of 11 bits (ID[10:0]) for the standard format. ID10 is the most significant bit and is transmitted first on the CAN bus during the arbitration procedure. The priority of an identifier is defined to be highest for the smallest binary number. See also ID bits in Table 12-29 .
4 RTR	Remote Transmission Request — This flag reflects the status of the Remote Transmission Request bit in the CAN frame. In the case of a receive buffer, it indicates the status of the received frame and supports the transmission of an answering frame in software. In the case of a transmit buffer, this flag defines the setting of the RTR bit to be sent. 0 Data frame 1 Remote frame
3 IDE	ID Extended — This flag indicates whether the extended or standard identifier format is applied in this buffer. In the case of a receive buffer, the flag is set as received and indicates to the CPU how to process the buffer identifier registers. In the case of a transmit buffer, the flag indicates to the MSCAN what type of identifier to send. 0 Standard format (11 bit) 1 Extended format (29 bit)

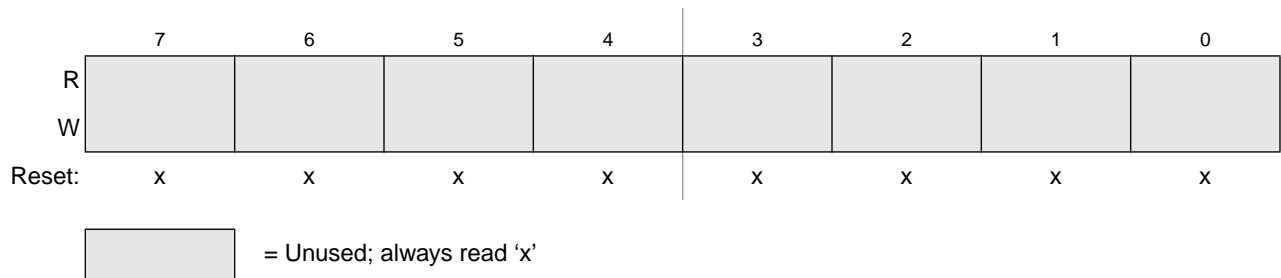
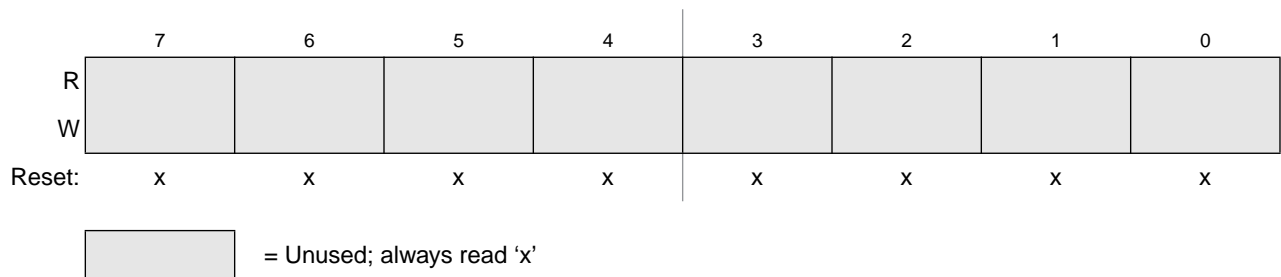
Figure 12-31. Identifier Register 2 — Standard Mapping

Figure 12-32. Identifier Register 3 — Standard Mapping

12.4.3 Data Segment Registers (DSR0-7)

The eight data segment registers, each with bits DB[7:0], contain the data to be transmitted or received. The number of bytes to be transmitted or received is determined by the data length code in the corresponding DLR register.

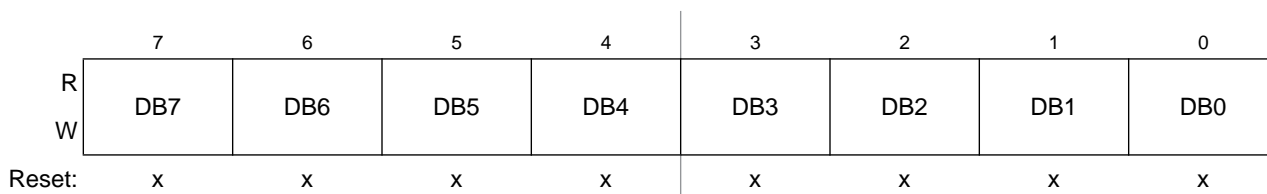

Figure 12-33. Data Segment Registers (DSR0–DSR7) — Extended Identifier Mapping

Table 12-31. DSR0–DSR7 Register Field Descriptions

Field	Description
7:0 DB[7:0]	Data bits 7:0

12.4.4 Data Length Register (DLR)

This register keeps the data length field of the CAN frame.

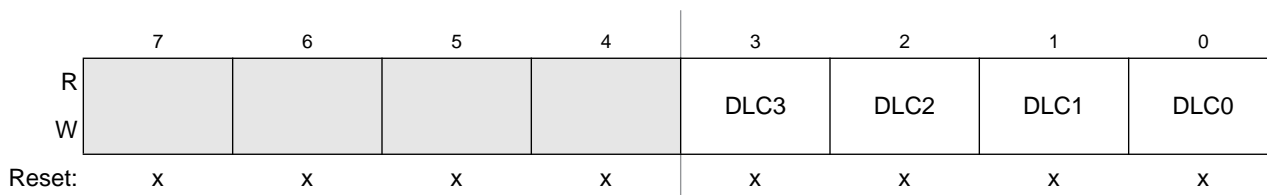

= Unused; always read "x"

Figure 12-34. Data Length Register (DLR) — Extended Identifier Mapping

Table 12-32. DLR Register Field Descriptions

Field	Description
3:0 DLC[3:0]	Data Length Code Bits — The data length code contains the number of bytes (data byte count) of the respective message. During the transmission of a remote frame, the data length code is transmitted as programmed while the number of transmitted data bytes is always 0. The data byte count ranges from 0 to 8 for a data frame. Table 12-33 shows the effect of setting the DLC bits.

Table 12-33. Data Length Codes

Data Length Code				Data Byte Count
DLC3	DLC2	DLC1	DLC0	
0	0	0	0	0
0	0	0	1	1
0	0	1	0	2
0	0	1	1	3
0	1	0	0	4
0	1	0	1	5
0	1	1	0	6
0	1	1	1	7
1	0	0	0	8

12.4.5 Transmit Buffer Priority Register (TBPR)

This register defines the local priority of the associated message transmit buffer. The local priority is used for the internal prioritization process of the MSCAN and is defined to be highest for the smallest binary number. The MSCAN implements the following internal prioritization mechanisms:

- All transmission buffers with a cleared TXEx flag participate in the prioritization immediately before the SOF (start of frame) is sent.
- The transmission buffer with the lowest local priority field wins the prioritization.

In cases of more than one buffer having the same lowest priority, the message buffer with the lower index number wins.

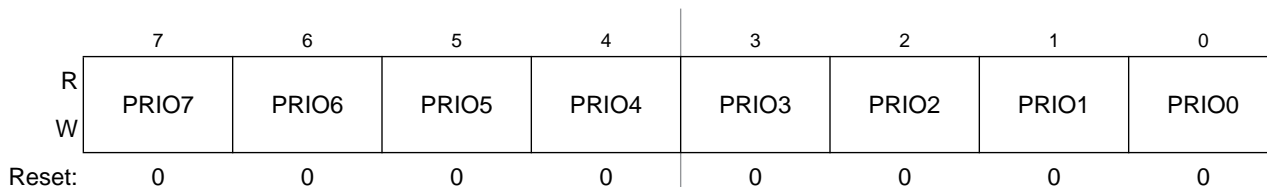
Figure 12-35. Transmit Buffer Priority Register (TBPR)

Read: Anytime when TXEx flag is set (see Section 12.3.6, “MSCAN Transmitter Flag Register (CANTFLG)”) and the corresponding transmit buffer is selected in CANTBSEL (see Section 12.3.10, “MSCAN Transmit Buffer Selection Register (CANTBSEL)”).

Write: Anytime when TXEx flag is set (see Section 12.3.6, “MSCAN Transmitter Flag Register (CANTFLG)”) and the corresponding transmit buffer is selected in CANTBSEL (see Section 12.3.10, “MSCAN Transmit Buffer Selection Register (CANTBSEL)”).

12.4.6 Time Stamp Register (TSRH–TSRL)

If the TIME bit is enabled, the MSCAN will write a time stamp to the respective registers in the active transmit or receive buffer as soon as a message has been acknowledged on the CAN bus (see

Section 12.3.1, “MSCAN Control Register 0 (CANCTL0)”). In case of a transmission, the CPU can only read the time stamp after the respective transmit buffer has been flagged empty.

The timer value, which is used for stamping, is taken from a free running internal CAN bit clock. A timer overrun is not indicated by the MSCAN. The timer is reset (all bits set to 0) during initialization mode. The CPU can only read the time stamp registers.

	7	6	5	4	3	2	1	0
R	TSR15	TSR14	TSR13	TSR12	TSR11	TSR10	TSR9	TSR8
W								
Reset:	x	x	x	x	x	x	x	x

Figure 12-36. Time Stamp Register — High Byte (TSRH)

	7	6	5	4	3	2	1	0
R	TSR7	TSR6	TSR5	TSR4	TSR3	TSR2	TSR1	TSR0
W								
Reset:	x	x	x	x	x	x	x	x

Figure 12-37. Time Stamp Register — Low Byte (TSRL)

Read: Anytime when TXEx flag is set (see Section 12.3.6, “MSCAN Transmitter Flag Register (CANTFLG)”) and the corresponding transmit buffer is selected in CANTBSEL (see Section 12.3.10, “MSCAN Transmit Buffer Selection Register (CANTBSEL)”).

Write: Unimplemented

12.5 Functional Description

12.5.1 General

This section provides a complete functional description of the MSCAN. It describes each of the features and modes listed in the introduction.

12.5.2 Message Storage

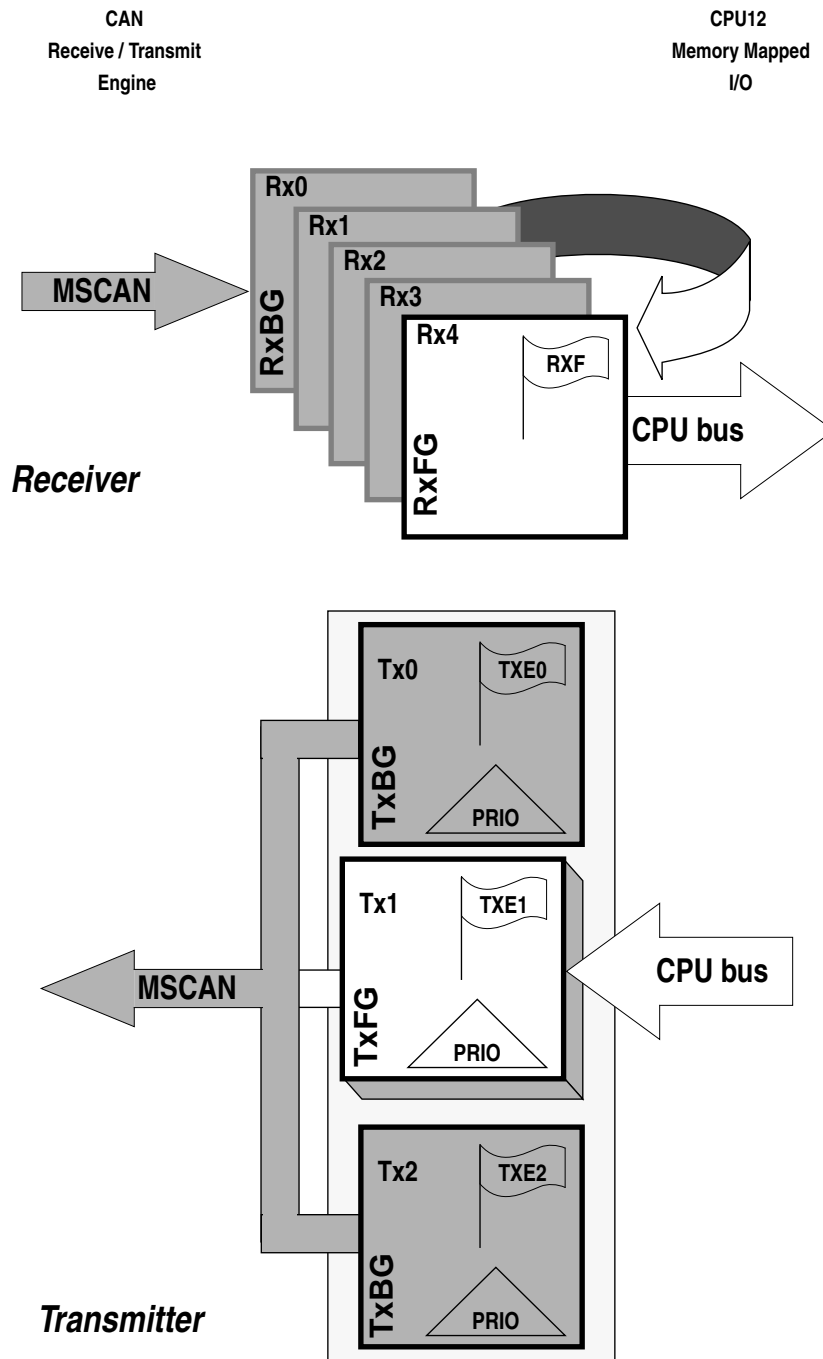

Figure 12-38. User Model for Message Buffer Organization

MSCAN facilitates a sophisticated message storage system which addresses the requirements of a broad range of network applications.

12.5.2.1 Message Transmit Background

Modern application layer software is built upon two fundamental assumptions:

- Any CAN node is able to send out a stream of scheduled messages without releasing the CAN bus between the two messages. Such nodes arbitrate for the CAN bus immediately after sending the previous message and only release the CAN bus in case of lost arbitration.
- The internal message queue within any CAN node is organized such that the highest priority message is sent out first, if more than one message is ready to be sent.

The behavior described in the bullets above cannot be achieved with a single transmit buffer. That buffer must be reloaded immediately after the previous message is sent. This loading process lasts a finite amount of time and must be completed within the inter-frame sequence (IFS) to be able to send an uninterrupted stream of messages. Even if this is feasible for limited CAN bus speeds, it requires that the CPU reacts with short latencies to the transmit interrupt.

A double buffer scheme de-couples the reloading of the transmit buffer from the actual message sending and, therefore, reduces the reactivity requirements of the CPU. Problems can arise if the sending of a message is finished while the CPU re-loads the second buffer. No buffer would then be ready for transmission, and the CAN bus would be released.

At least three transmit buffers are required to meet the first of the above requirements under all circumstances. The MSCAN has three transmit buffers.

The second requirement calls for some sort of internal prioritization which the MSCAN implements with the “local priority” concept described in [Section 12.5.2.2, “Transmit Structures.”](#)

12.5.2.2 Transmit Structures

The MSCAN triple transmit buffer scheme optimizes real-time performance by allowing multiple messages to be set up in advance. The three buffers are arranged as shown in [Figure 12-38](#).

All three buffers have a 13-byte data structure similar to the outline of the receive buffers (see [Section 12.4, “Programmer’s Model of Message Storage”](#)). An additional [Section 12.4.5, “Transmit Buffer Priority Register \(TBPR\)”](#) contains an 8-bit local priority field (PRIO) (see [Section 12.4.5, “Transmit Buffer Priority Register \(TBPR\)”](#)). The remaining two bytes are used for time stamping of a message, if required (see [Section 12.4.6, “Time Stamp Register \(TSRH–TSRL\)”](#)).

To transmit a message, the CPU must identify an available transmit buffer, which is indicated by a set transmitter buffer empty (TXEx) flag (see [Section 12.3.6, “MSCAN Transmitter Flag Register \(CANTFLG\)”](#)). If a transmit buffer is available, the CPU must set a pointer to this buffer by writing to the CANTBSEL register (see [Section 12.3.10, “MSCAN Transmit Buffer Selection Register \(CANTBSEL\)”](#)). This makes the respective buffer accessible within the CANTXFG address space (see [Section 12.4, “Programmer’s Model of Message Storage”](#)). The algorithmic feature associated with the CANTBSEL register simplifies the transmit buffer selection. In addition, this scheme makes the handler software simpler because only one address area is applicable for the transmit process, and the required address space is minimized.

The CPU then stores the identifier, the control bits, and the data content into one of the transmit buffers. Finally, the buffer is flagged as ready for transmission by clearing the associated TXE flag.

The MSCAN then schedules the message for transmission and signals the successful transmission of the buffer by setting the associated TXE flag. A transmit interrupt (see [Section 12.5.7.2, “Transmit Interrupt”](#)) is generated¹ when TXEx is set and can be used to drive the application software to re-load the buffer.

If more than one buffer is scheduled for transmission when the CAN bus becomes available for arbitration, the MSCAN uses the local priority setting of the three buffers to determine the prioritization. For this purpose, every transmit buffer has an 8-bit local priority field (PRIO). The application software programs this field when the message is set up. The local priority reflects the priority of this particular message relative to the set of messages being transmitted from this node. The lowest binary value of the PRIO field is defined to be the highest priority. The internal scheduling process takes place whenever the MSCAN arbitrates for the CAN bus. This is also the case after the occurrence of a transmission error.

When a high priority message is scheduled by the application software, it may become necessary to abort a lower priority message in one of the three transmit buffers. Because messages that are already in transmission cannot be aborted, the user must request the abort by setting the corresponding abort request bit (ABTRQ) (see [Section 12.3.8, “MSCAN Transmitter Message Abort Request Register \(CANTARQ\)”](#).) The MSCAN then grants the request, if possible, by:

1. Setting the corresponding abort acknowledge flag (ABTAK) in the CANTAACK register.
2. Setting the associated TXE flag to release the buffer.
3. Generating a transmit interrupt. The transmit interrupt handler software can determine from the setting of the ABTAK flag whether the message was aborted (ABTAK = 1) or sent (ABTAK = 0).

12.5.2.3 Receive Structures

The received messages are stored in a five stage input FIFO. The five message buffers are alternately mapped into a single memory area (see [Figure 12-38](#)). The background receive buffer (RxBG) is exclusively associated with the MSCAN, but the foreground receive buffer (RxFG) is addressable by the CPU (see [Figure 12-38](#)). This scheme simplifies the handler software because only one address area is applicable for the receive process.

All receive buffers have a size of 15 bytes to store the CAN control bits, the identifier (standard or extended), the data contents, and a time stamp, if enabled (see [Section 12.4, “Programmer’s Model of Message Storage”](#)).

The receiver full flag (RXF) (see [Section 12.3.4.1, “MSCAN Receiver Flag Register \(CANRFLG\)”](#)) signals the status of the foreground receive buffer. When the buffer contains a correctly received message with a matching identifier, this flag is set.

On reception, each message is checked to see whether it passes the filter (see [Section 12.5.3, “Identifier Acceptance Filter”](#)) and simultaneously is written into the active RxBG. After successful reception of a valid message, the MSCAN shifts the content of RxBG into the receiver FIFO², sets the RXF flag, and generates a receive interrupt (see [Section 12.5.7.3, “Receive Interrupt”](#)) to the CPU³. The user’s receive handler must read the received message from the RxFG and then reset the RXF flag to acknowledge the interrupt and to release the foreground buffer. A new message, which can follow immediately after the IFS

1. The transmit interrupt occurs only if not masked. A polling scheme can be applied on TXEx also.

2. Only if the RXF flag is not set.

3. The receive interrupt occurs only if not masked. A polling scheme can be applied on RXF also.

field of the CAN frame, is received into the next available RxBG. If the MSCAN receives an invalid message in its RxBG (wrong identifier, transmission errors, etc.) the actual contents of the buffer will be over-written by the next message. The buffer will then not be shifted into the FIFO.

When the MSCAN module is transmitting, the MSCAN receives its own transmitted messages into the background receive buffer, RxBG, but does not shift it into the receiver FIFO, generate a receive interrupt, or acknowledge its own messages on the CAN bus. The exception to this rule is in loopback mode (see Section 12.3.2, “MSCAN Control Register 1 (CANCTL1)”) where the MSCAN treats its own messages exactly like all other incoming messages. The MSCAN receives its own transmitted messages in the event that it loses arbitration. If arbitration is lost, the MSCAN must be prepared to become a receiver.

An overrun condition occurs when all receive message buffers in the FIFO are filled with correctly received messages with accepted identifiers and another message is correctly received from the CAN bus with an accepted identifier. The latter message is discarded and an error interrupt with overrun indication is generated if enabled (see Section 12.5.7.5, “Error Interrupt”). The MSCAN remains able to transmit messages while the receiver FIFO is full, but all incoming messages are discarded. As soon as a receive buffer in the FIFO is available again, new valid messages will be accepted.

12.5.3 Identifier Acceptance Filter

The MSCAN identifier acceptance registers (see Section 12.3.11, “MSCAN Identifier Acceptance Control Register (CANIDAC)”) define the acceptable patterns of the standard or extended identifier (ID[10:0] or ID[28:0]). Any of these bits can be marked ‘don’t care’ in the MSCAN identifier mask registers (see Section 12.3.16, “MSCAN Identifier Mask Registers (CANIDMR0–CANIDMR7)”).

A filter hit is indicated to the application software by a set receive buffer full flag (RXF = 1) and three bits in the CANIDAC register (see Section 12.3.11, “MSCAN Identifier Acceptance Control Register (CANIDAC)”). These identifier hit flags (IDHIT[2:0]) clearly identify the filter section that caused the acceptance. They simplify the application software’s task to identify the cause of the receiver interrupt. If more than one hit occurs (two or more filters match), the lower hit has priority.

A very flexible programmable generic identifier acceptance filter has been introduced to reduce the CPU interrupt loading. The filter is programmable to operate in four different modes (see Bosch CAN 2.0A/B protocol specification):

- Two identifier acceptance filters, each to be applied to:
 - The full 29 bits of the extended identifier and to the following bits of the CAN 2.0B frame:
 - Remote transmission request (RTR)
 - Identifier extension (IDE)
 - Substitute remote request (SRR)
 - The 11 bits of the standard identifier plus the RTR and IDE bits of the CAN 2.0A/B messages¹. This mode implements two filters for a full length CAN 2.0B compliant extended identifier. Figure 12-39 shows how the first 32-bit filter bank (CANIDAR0–CANIDAR3, CANIDMR0–CANIDMR3) produces a filter 0 hit. Similarly, the second filter bank (CANIDAR4–CANIDAR7, CANIDMR4–CANIDMR7) produces a filter 1 hit.

¹.Although this mode can be used for standard identifiers, it is recommended to use the four or eight identifier acceptance filters for standard identifiers

- Four identifier acceptance filters, each to be applied to
 - a) the 14 most significant bits of the extended identifier plus the SRR and IDE bits of CAN 2.0B messages or
 - b) the 11 bits of the standard identifier, the RTR and IDE bits of CAN 2.0A/B messages.
 Figure 12-40 shows how the first 32-bit filter bank (CANIDAR0–CANIDA3, CANIDMR0–3CANIDMR) produces filter 0 and 1 hits. Similarly, the second filter bank (CANIDAR4–CANIDAR7, CANIDMR4–CANIDMR7) produces filter 2 and 3 hits.
- Eight identifier acceptance filters, each to be applied to the first 8 bits of the identifier. This mode implements eight independent filters for the first 8 bits of a CAN 2.0A/B compliant standard identifier or a CAN 2.0B compliant extended identifier. Figure 12-41 shows how the first 32-bit filter bank (CANIDAR0–CANIDAR3, CANIDMR0–CANIDMR3) produces filter 0 to 3 hits. Similarly, the second filter bank (CANIDAR4–CANIDAR7, CANIDMR4–CANIDMR7) produces filter 4 to 7 hits.
- Closed filter. No CAN message is copied into the foreground buffer RxFG, and the RXF flag is never set.

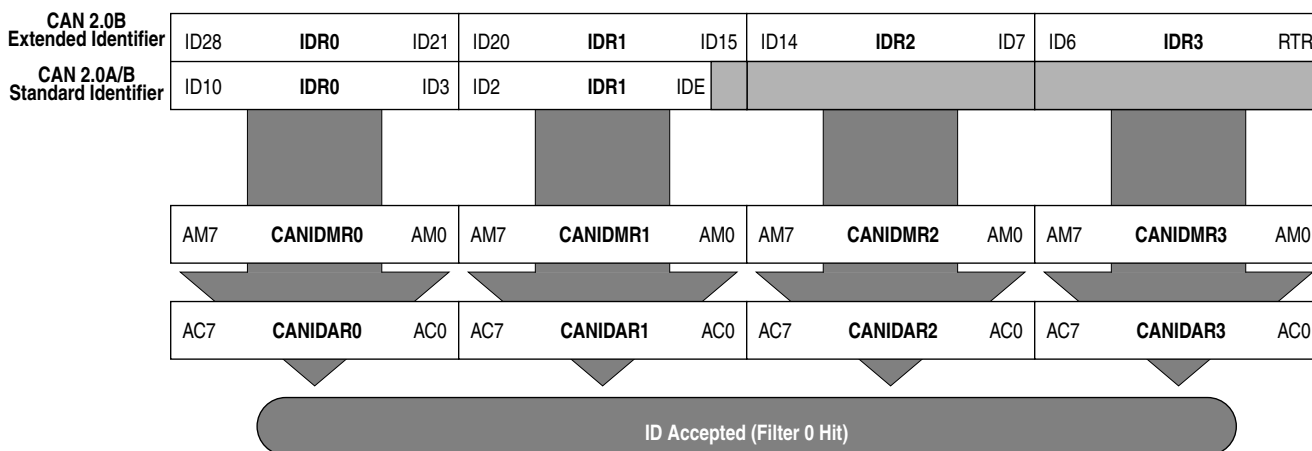

Figure 12-39. 32-bit Maskable Identifier Acceptance Filter

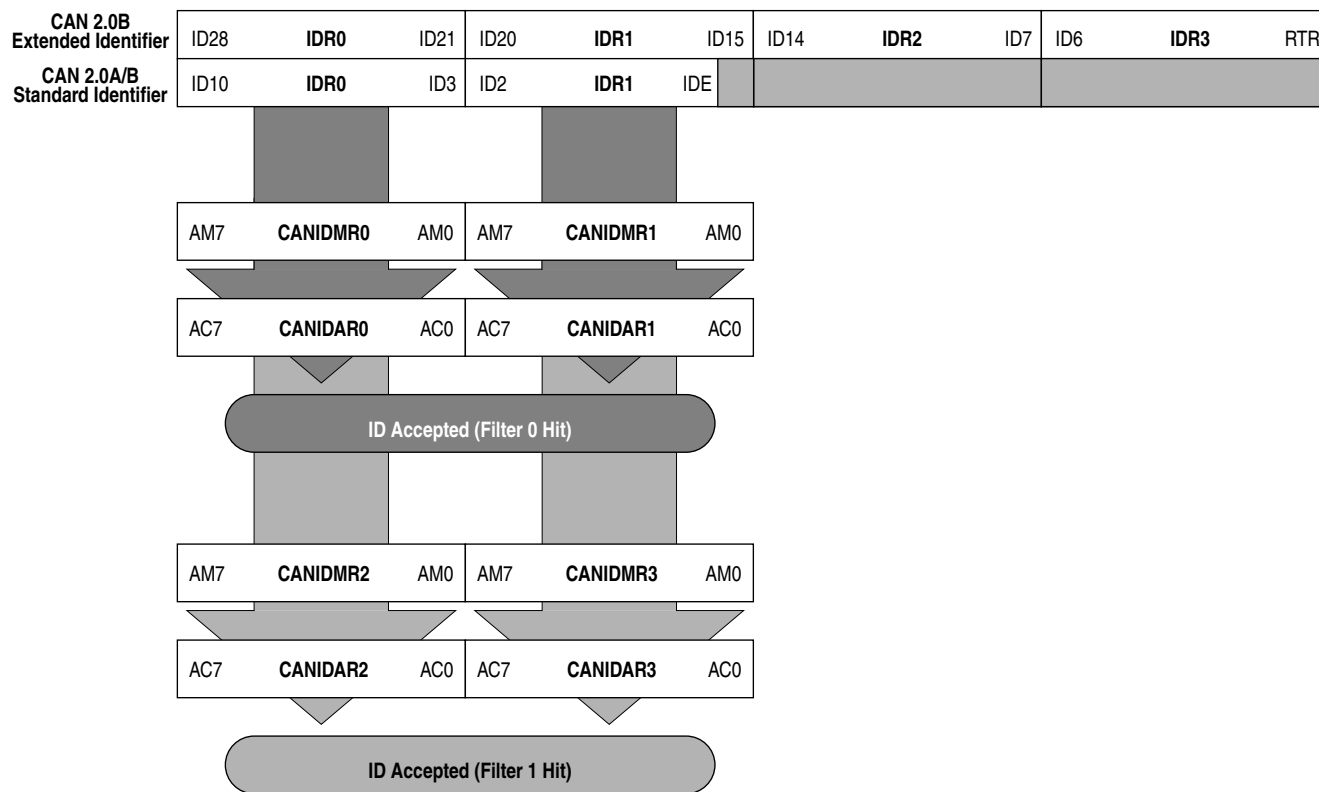

Figure 12-40. 16-bit Maskable Identifier Acceptance Filters

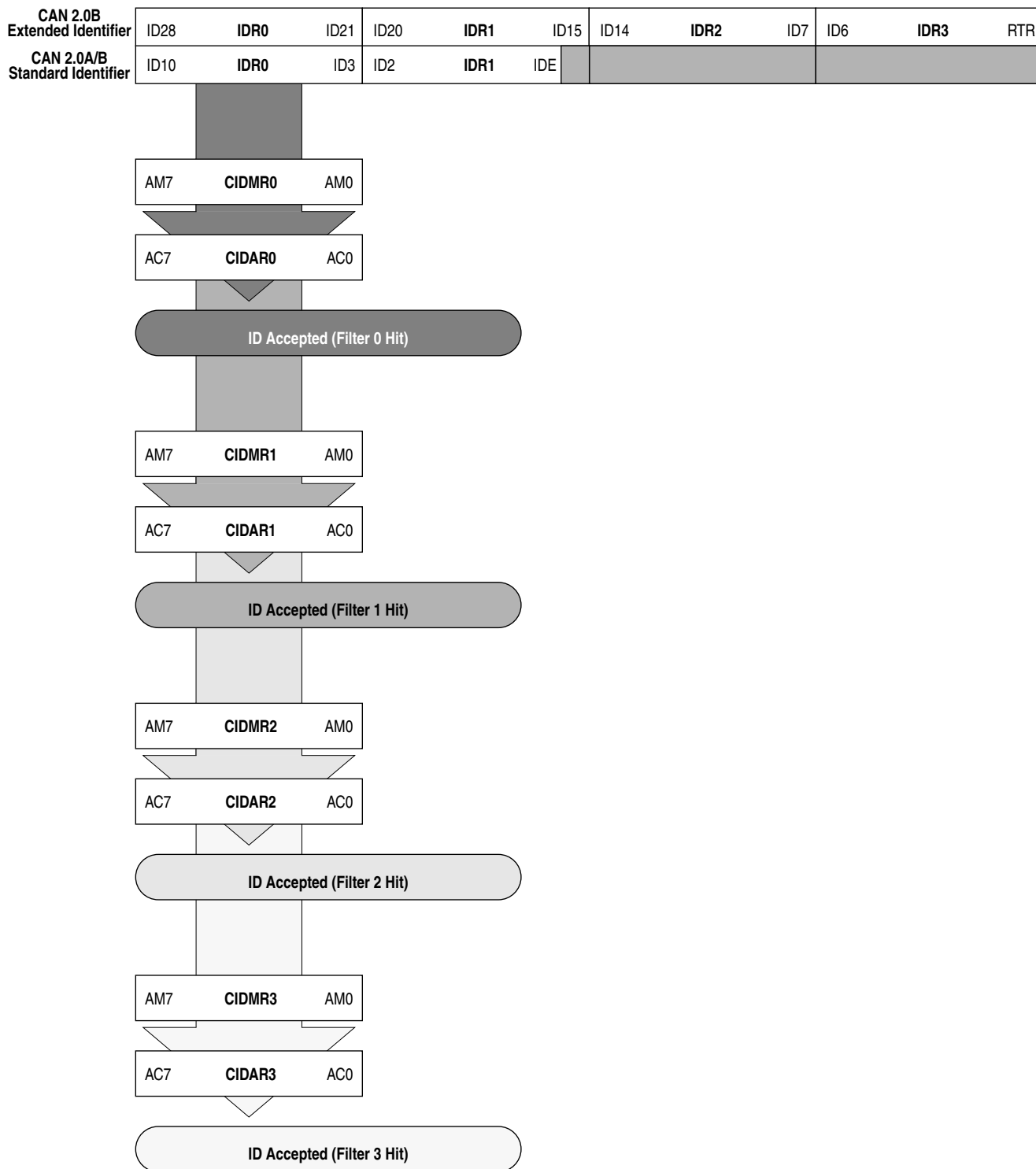

Figure 12-41. 8-bit Maskable Identifier Acceptance Filters

MSCAN filter uses three sets of registers to provide the filter configuration. Firstly, the CANIDAC register determines the configuration of the banks into filter sizes and number of filters. Secondly, registers CANIDMR0/1/2/3 determine those bits on which the filter will operate by placing a '0' at the appropriate

bit position in the filter register. Finally, registers CANIDAR0/1/2/3 determine the value of those bits determined by CANIDMR0/1/2/3.

For instance in the case of the filter value of:

0001x1001x0

The CANIDMR0/1/2/3 register would be configured as:

00001000010

and so all message identifier bits except bit 1 and bit 6 would be compared against the CANIDAR0/1/2/3 registers. These would be configured as:

00010100100

In this case bits 1 and 6 are set to '0', but since they are ignored it is equally valid to set them to '1'.

12.5.3.1 Identifier Acceptance Filters example

As described above, filters work by comparisons to individual bits in the CAN message identifier field. The filter will check each one of the eleven bits of a standard CAN message identifier. Suppose a filter value of 0001x1001x0. In this simple example, there are only three possible CAN messages.

Filter value: 0001x1001x0

Message 1: 00011100110

Message 2: 00110100110

Message 3: 00010100100

Message 2 will be rejected since its third most significant bit is not '0' - 001. The filter is simply a convenient way of defining the set of messages that the CPU must receive. For full 29-bits of an extended CAN message identifier, the filter identifies two sets of messages: one set that it receives and one set that it rejects. Alternatively, the filter may be split into two. This allows the MSCAN to examine only the first 16 bits of a message identifier, but allows two separate filters to perform the checking. See the example below:

Filter value A: 0001x1001x0

Filter value B: 00x101x01x0

Message 1: 00011100110

Message 2: 00110100110

Message 3: 00010100100

MSCAN will accept all three messages. Filter A will accept messages 1 and 3 as before and filter B will accept message 2. In practice, it is unimportant which filter accepts the message - messages accepted by either will be placed in the input buffer. A message may be accepted by more than one filter.

12.5.3.2 Protocol Violation Protection

The MSCAN protects the user from accidentally violating the CAN protocol through programming errors. The protection logic implements the following features:

- The receive and transmit error counters cannot be written or otherwise manipulated.
- All registers which control the configuration of the MSCAN cannot be modified while the MSCAN is on-line. The MSCAN has to be in Initialization Mode. The corresponding INITRQ/INITAK handshake bits in the CANCTL0/CANCTL1 registers (see Section 12.3.1, “MSCAN Control Register 0 (CANCTL0)”) serve as a lock to protect the following registers:
 - MSCAN control 1 register (CANCTL1)
 - MSCAN bus timing registers 0 and 1 (CANBTR0, CANBTR1)
 - MSCAN identifier acceptance control register (CANIDAC)
 - MSCAN identifier acceptance registers (CANIDAR0–CANIDAR7)
 - MSCAN identifier mask registers (CANIDMR0–CANIDMR7)
- The TXCAN pin is immediately forced to a recessive state when the MSCAN goes into the power down mode or initialization mode (see Section 12.5.5.6, “MSCAN Power Down Mode,” and Section 12.5.5.5, “MSCAN Initialization Mode”).
- The MSCAN enable bit (CANE) is writable only once in normal system operation modes, which provides further protection against inadvertently disabling the MSCAN.

12.5.3.3 Clock System

Figure 12-42 shows the structure of the MSCAN clock generation circuitry.

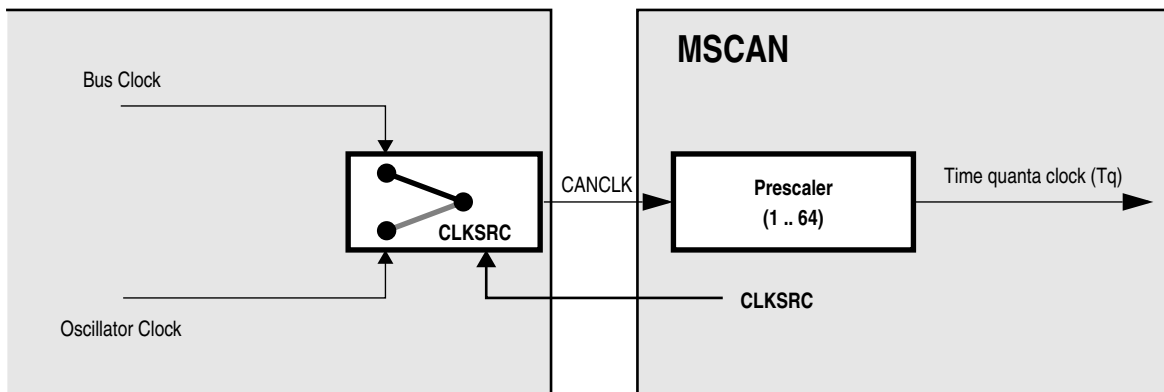

Figure 12-42. MSCAN Clocking Scheme

The clock source bit (CLKSRC) in the CANCTL1 register (12.3.2/-260) defines whether the internal CANCLK is connected to the output of a crystal oscillator (oscillator clock) or to the bus clock.

The clock source has to be chosen such that the tight oscillator tolerance requirements (up to 0.4%) of the CAN protocol are met. Additionally, for high CAN bus rates (1 Mbps), a 45% to 55% duty cycle of the clock is required.

If the bus clock is generated from a PLL, it is recommended to select the oscillator clock rather than the bus clock due to jitter considerations, especially at the faster CAN bus rates. PLL lock may also be too wide to ensure adequate clock tolerance.

For microcontrollers without a clock and reset generator (CRG), CANCLK is driven from the crystal oscillator (oscillator clock).

A programmable prescaler generates the time quanta (Tq) clock from CANCLK. A time quantum is the atomic unit of time handled by the MSCAN.

Eqn. 12-2

$$Tq = \frac{f_{CANCLK}}{\text{(Prescaler value)}}$$

A bit time is subdivided into three segments as described in the Bosch CAN specification. (see Figure 12-43):

- SYNC_SEG: This segment has a fixed length of one time quantum. Signal edges are expected to happen within this section.
- Time Segment 1: This segment includes the PROP_SEG and the PHASE_SEG1 of the CAN standard. It can be programmed by setting the parameter TSEG1 to consist of 4 to 16 time quanta.
- Time Segment 2: This segment represents the PHASE_SEG2 of the CAN standard. It can be programmed by setting the TSEG2 parameter to be 2 to 8 time quanta long.

Eqn. 12-3

$$\text{Bit Rate} = \frac{f_{Tq}}{\text{(number of Time Quanta)}}$$

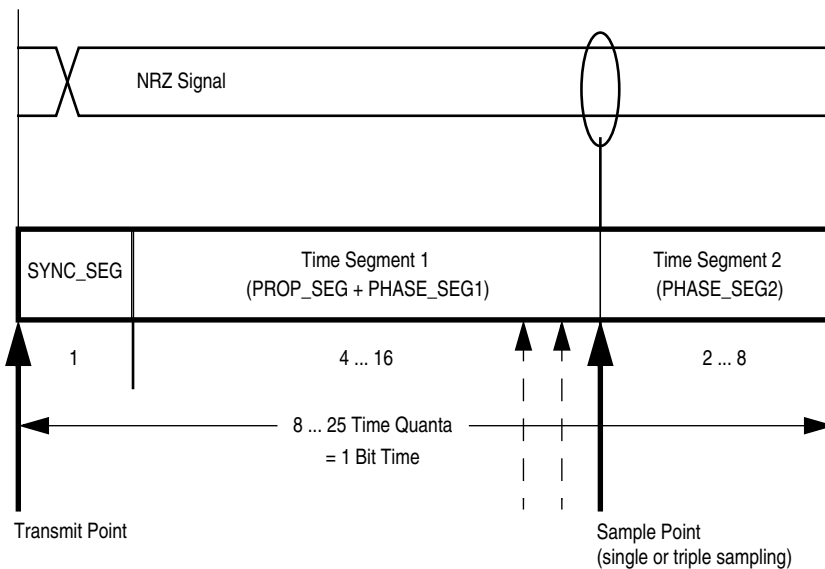

Figure 12-43. Segments within the Bit Time

Table 12-34. Time Segment Syntax

Syntax	Description
SYNC_SEG	System expects transitions to occur on the CAN bus during this period.
Transmit Point	A node in transmit mode transfers a new value to the CAN bus at this point.
Sample Point	A node in receive mode samples the CAN bus at this point. If the three samples per bit option is selected, then this point marks the position of the third sample.

The synchronization jump width (see the Bosch CAN specification for details) can be programmed in a range of 1 to 4 time quanta by setting the SJW parameter.

The SYNC_SEG, TSEG1, TSEG2, and SJW parameters are set by programming the MSCAN bus timing registers (CANBTR0, CANBTR1) (see [Section 12.3.3, “MSCAN Bus Timing Register 0 \(CANBTR0\)”](#) and [Section 12.3.4, “MSCAN Bus Timing Register 1 \(CANBTR1\)”](#)).

[Table 12-35](#) gives an overview of the CAN compliant segment settings and the related parameter values.

NOTE

It is the user's responsibility to ensure the bit time settings are in compliance with the CAN standard.

Table 12-35. CAN Standard Compliant Bit Time Segment Settings

Time Segment 1	TSEG1	Time Segment 2	TSEG2	Synchronization Jump Width	SJW
5 .. 10	4 .. 9	2	1	1 .. 2	0 .. 1
4 .. 11	3 .. 10	3	2	1 .. 3	0 .. 2
5 .. 12	4 .. 11	4	3	1 .. 4	0 .. 3
6 .. 13	5 .. 12	5	4	1 .. 4	0 .. 3
7 .. 14	6 .. 13	6	5	1 .. 4	0 .. 3
8 .. 15	7 .. 14	7	6	1 .. 4	0 .. 3
9 .. 16	8 .. 15	8	7	1 .. 4	0 .. 3

12.5.4 Modes of Operation

12.5.4.1 Normal Modes

The MSCAN module behaves as described within this specification in all normal system operation modes.

12.5.4.2 Special Modes

The MSCAN module behaves as described within this specification in all special system operation modes.

12.5.4.3 Emulation Modes

In all emulation modes, the MSCAN module behaves just like normal system operation modes as described within this specification.

12.5.4.4 Listen-Only Mode

In an optional CAN bus monitoring mode (listen-only), the CAN node is able to receive valid data frames and valid remote frames, but it sends only “recessive” bits on the CAN bus. In addition, it cannot start a transmission. If the MAC sub-layer is required to send a “dominant” bit (ACK bit, overload flag, or active error flag), the bit is rerouted internally so that the MAC sub-layer monitors this “dominant” bit, although the CAN bus may remain in recessive state externally.

12.5.4.5 Security Modes

The MSCAN module has no security features.

12.5.4.6 Loopback Self Test Mode

Loopback self test mode is sometimes used to check software, independent of connections in the external system, to help isolate system problems. In this mode, the transmitter output is internally connected to the receiver input. The RXCAN input pin is ignored and the TXCAN output goes to the recessive state (logic 1). The MSCAN behaves as it does normally when transmitting and treats its own transmitted message as a message received from a remote node. In this state, the MSCAN ignores the bit sent during the ACK slot in the CAN frame acknowledge field to ensure proper reception of its own message. Both transmit and receive interrupts are generated.

12.5.5 Low-Power Options

If the MSCAN is disabled ($CANE = 0$), the MSCAN clocks are stopped for power saving.

If the MSCAN is enabled ($CANE = 1$), the MSCAN has two additional modes with reduced power consumption, compared to normal mode: sleep and power down mode. In sleep mode, power consumption is reduced by stopping all clocks except those to access the registers from the CPU side. In power down mode, all clocks are stopped and no power is consumed.

[Table 12-36](#) summarizes the combinations of MSCAN and CPU modes. A particular combination of modes is entered by the given settings on the CSWAI and SLPRQ/SLPAK bits.

For all modes, an MSCAN wake-up interrupt can occur only if the MSCAN is in sleep mode ($SLPRQ = 1$ and $SLPAK = 1$), wake-up functionality is enabled ($WUPE = 1$), and the wake-up interrupt is enabled ($WUPIE = 1$).

Table 12-36. CPU vs. MSCAN Operating Modes

CPU Mode	MSCAN Mode			
	Normal	Reduced Power Consumption		
		Sleep	Power Down	Disabled (CANE=0)
Run	CSWAI = X ¹ SLPRQ = 0 SLPAK = 0	CSWAI = X SLPRQ = 1 SLPAK = 1		CSWAI = X SLPRQ = X SLPAK = X
Wait	CSWAI = 0 SLPRQ = 0 SLPAK = 0	CSWAI = 0 SLPRQ = 1 SLPAK = 1	CSWAI = 1 SLPRQ = X SLPAK = X	CSWAI = X SLPRQ = X SLPAK = X
Stop3		CSWAI = X ² SLPRQ = 1 SLPAK = 1	CSWAI = X SLPRQ = 0 SLPAK = 0	CSWAI = X SLPRQ = X SLPAK = X
Stop1 or 2			CSWAI = X SLPRQ = X SLPAK = X	CSWAI = X SLPRQ = X SLPAK = X

¹ 'X' means don't care.

² For a safe wake up from Sleep mode, SLPRQ and SLPAK must be set to 1 before going into Stop3 mode.

12.5.5.1 Operation in Run Mode

As shown in [Table 12-36](#), only MSCAN sleep mode is available as low power option when the CPU is in run mode.

12.5.5.2 Operation in Wait Mode

The WAIT instruction puts the MCU in a low power consumption stand-by mode. If the CSWAI bit is set, additional power can be saved in power down mode because the CPU clocks are stopped. After leaving this power down mode, the MSCAN restarts its internal controllers and enters normal mode again.

While the CPU is in wait mode, the MSCAN can be operated in normal mode and generate interrupts (registers can be accessed via background debug mode). The MSCAN can also operate in any of the low-power modes depending on the values of the SLPRQ/SLPAK and CSWAI bits as seen in [Table 12-36](#).

12.5.5.3 Operation in Stop Mode

The STOP instruction puts the MCU in a low power consumption stand-by mode. In stop1 or stop2 modes, the MSCAN is set in power down mode regardless of the value of the SLPRQ/SLPAK. In stop3 mode, power down or sleep modes are determined by the SLPRQ/SLPAK values set prior to entering stop3. CSWAI bit has no function in any of the stop modes. [Table 12-36](#).

12.5.5.4 MSCAN Sleep Mode

The CPU can request the MSCAN to enter this low power mode by asserting the SLPRQ bit in the CANCTL0 register. The time when the MSCAN enters sleep mode depends on a fixed synchronization delay and its current activity:

- If there are one or more message buffers scheduled for transmission (TXEx = 0), the MSCAN will continue to transmit until all transmit message buffers are empty (TXEx = 1, transmitted successfully or aborted) and then goes into sleep mode.
- If the MSCAN is receiving, it continues to receive and goes into sleep mode as soon as the CAN bus next becomes idle.
- If the MSCAN is neither transmitting nor receiving, it immediately goes into sleep mode.

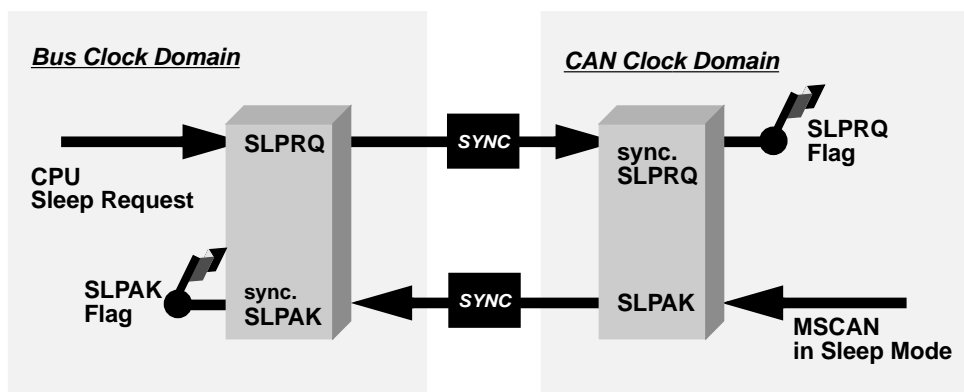

Figure 12-44. Sleep Request / Acknowledge Cycle

NOTE

The application software must avoid setting up a transmission (by clearing one or more TXEx flag(s)) and immediately request sleep mode (by setting SLPRQ). Whether the MSCAN starts transmitting or goes into sleep mode directly depends on the exact sequence of operations.

If sleep mode is active, the SLPRQ and SLPK bits are set (Figure 12-44). The application software must use SLPK as a handshake indication for the request (SLPRQ) to go into sleep mode.

When in sleep mode (SLPRQ = 1 and SLPK = 1), the MSCAN stops its internal clocks. However, clocks that allow register accesses from the CPU side continue to run.

If the MSCAN is in bus-off state, it stops counting the 128 occurrences of 11 consecutive recessive bits due to the stopped clocks. The TXCAN pin remains in a recessive state. If RXF = 1, the message can be read and RXF can be cleared. Shifting a new message into the foreground buffer of the receiver FIFO (RxFG) does not take place while in sleep mode.

It is possible to access the transmit buffers and to clear the associated TXE flags. No message abort takes place while in sleep mode.

If the WUPE bit in CANCLT0 is not asserted, the MSCAN will mask any activity it detects on CAN. The RXCAN pin is therefore held internally in a recessive state. This locks the MSCAN in sleep mode (Figure 12-45). WUPE must be set before entering sleep mode to take effect.

The MSCAN is able to leave sleep mode (wake up) only when:

- CAN bus activity occurs and $WUPE = 1$
or
- the CPU clears the SLPRQ bit

NOTE

The CPU cannot clear the SLPRQ bit before sleep mode ($SLPRQ = 1$ and $SLPAK = 1$) is active.

After wake-up, the MSCAN waits for 11 consecutive recessive bits to synchronize to the CAN bus. As a consequence, if the MSCAN is woken-up by a CAN frame, this frame is not received.

The receive message buffers (RxFG and RxBG) contain messages if they were received before sleep mode was entered. All pending actions will be executed upon wake-up; copying of RxBG into RxFG, message aborts and message transmissions. If the MSCAN remains in bus-off state after sleep mode was exited, it continues counting the 128 occurrences of 11 consecutive recessive bits.

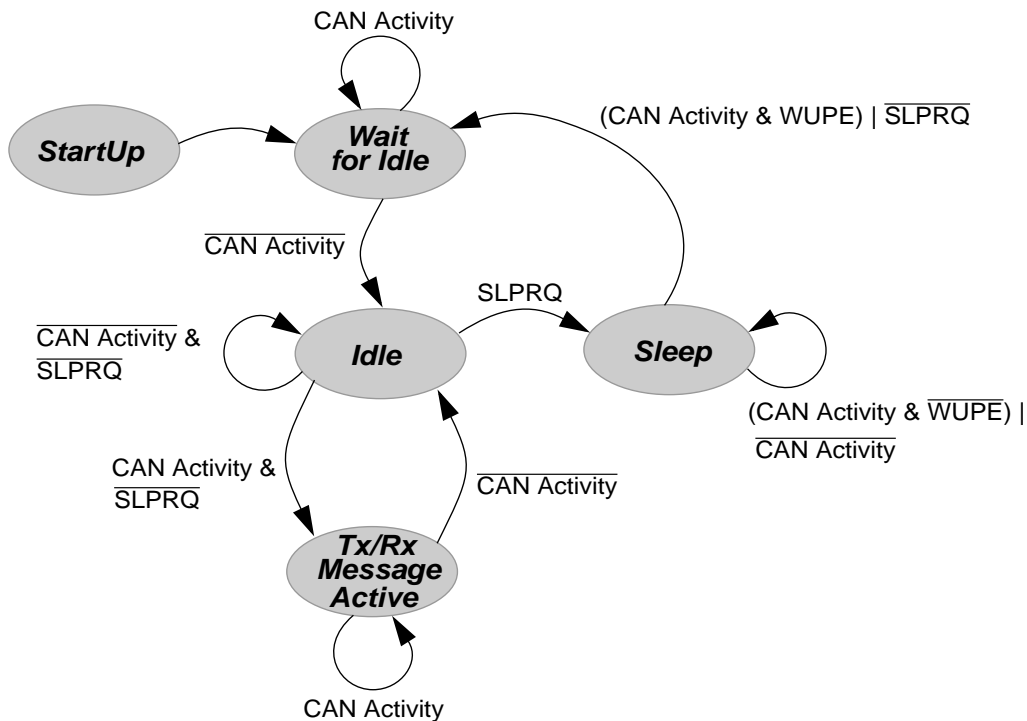

Figure 12-45. Simplified State Transitions for Entering/Leaving Sleep Mode

12.5.5.5 MSCAN Initialization Mode

In initialization mode, any on-going transmission or reception is immediately aborted and synchronization to the CAN bus is lost, potentially causing CAN protocol violations. To protect the CAN bus system from fatal consequences of violations, the MSCAN immediately drives the TXCAN pin into a recessive state.

NOTE

The user is responsible for ensuring that the MSCAN is not active when initialization mode is entered. The recommended procedure is to bring the MSCAN into sleep mode (SLPRQ = 1 and SLPK = 1) before setting the INITRQ bit in the CANCTL0 register. Otherwise, the abort of an on-going message can cause an error condition and can impact other CAN bus devices.

In initialization mode, the MSCAN is stopped. However, interface registers remain accessible. This mode is used to reset the CANCTL0, CANRFLG, CANRIER, CANTFLG, CANTIER, CANTARQ, CANTAACK, and CANTBSEL registers to their default values. In addition, the MSCAN enables the configuration of the CANBTR0, CANBTR1 bit timing registers; CANIDAC; and the CANIDAR, CANIDMR message filters. See Section 12.3.1, “MSCAN Control Register 0 (CANCTL0),” for a detailed description of the initialization mode.

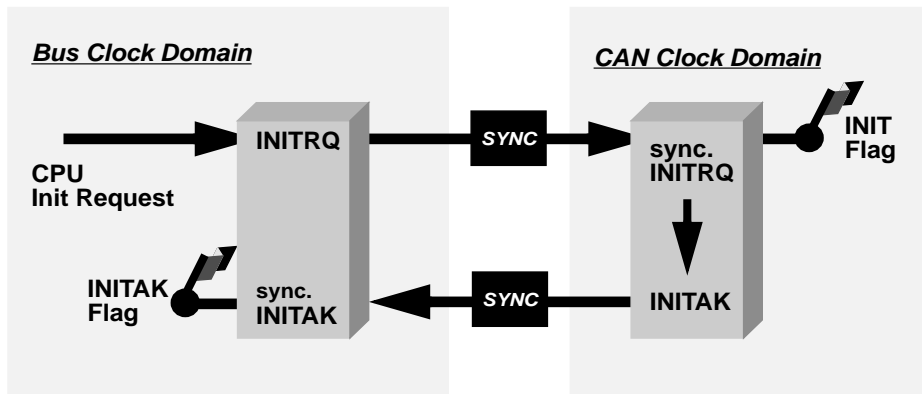

Figure 12-46. Initialization Request/Acknowledge Cycle

Due to independent clock domains within the MSCAN, INITRQ must be synchronized to all domains by using a special handshake mechanism. This handshake causes additional synchronization delay (see Section Figure 12-46., “Initialization Request/Acknowledge Cycle”).

If there is no message transfer ongoing on the CAN bus, the minimum delay will be two additional bus clocks and three additional CAN clocks. When all parts of the MSCAN are in initialization mode, the INITAK flag is set. The application software must use INITAK as a handshake indication for the request (INITRQ) to go into initialization mode.

NOTE

The CPU cannot clear INITRQ before initialization mode (INITRQ = 1 and INITAK = 1) is active.

12.5.5.6 MSCAN Power Down Mode

The MSCAN is in power down mode (Table 12-36) when

- CPU is in stop mode
- or
- CPU is in wait mode and the CSWAI bit is set

When entering the power down mode, the MSCAN immediately stops all ongoing transmissions and receptions, potentially causing CAN protocol violations. To protect the CAN bus system from fatal consequences of violations to the above rule, the MSCAN immediately drives the TXCAN pin into a recessive state.

NOTE

The user is responsible for ensuring that the MSCAN is not active when power down mode is entered. The recommended procedure is to bring the MSCAN into Sleep mode before the STOP or WAIT instruction (if CSWAI is set) is executed. Otherwise, the abort of an ongoing message can cause an error condition and impact other CAN bus devices.

In power down mode, all clocks are stopped and no registers can be accessed. If the MSCAN was not in sleep mode before power down mode became active, the module performs an internal recovery cycle after powering up. This causes some fixed delay before the module enters normal mode again.

12.5.5.7 Programmable Wake-Up Function

The MSCAN can be programmed to wake up the MSCAN as soon as CAN bus activity is detected (see control bit WUPE in Section 12.3.1, “MSCAN Control Register 0 (CANCTL0)”). The sensitivity to existing CAN bus action can be modified by applying a low-pass filter function to the RXCAN input line while in sleep mode (see control bit WUPM in Section 12.3.2, “MSCAN Control Register 1 (CANCTL1)”).

This feature can be used to protect the MSCAN from wake-up due to short glitches on the CAN bus lines. Such glitches can result from—for example—electromagnetic interference within noisy environments.

12.5.6 Reset Initialization

The reset state of each individual bit is listed in Section 12.3, “Register Definition,” which details all the registers and their bit-fields.

12.5.7 Interrupts

This section describes all interrupts originated by the MSCAN. It documents the enable bits and generated flags. Each interrupt is listed and described separately.

12.5.7.1 Description of Interrupt Operation

The MSCAN supports four interrupt vectors (see [Table 12-37](#)), any of which can be individually masked (for details see sections from [Section 12.3.5](#), “MSCAN Receiver Interrupt Enable Register (CANRIER),” to [Section 12.3.7](#), “MSCAN Transmitter Interrupt Enable Register (CANTIER)”).

NOTE

The dedicated interrupt vector addresses are defined in the [Resets and Interrupts](#) chapter.

Table 12-37. Interrupt Vectors

Interrupt Source	CCR Mask	Local Enable
Wake-Up Interrupt (WUPIF)	1 bit	CANRIER (WUPIE)
Error Interrupts Interrupt (CSCIF, OVRIF)	1 bit	CANRIER (CSCIE, OVRIE)
Receive Interrupt (RXF)	1 bit	CANRIER (RXFIE)
Transmit Interrupts (TXE[2:0])	1 bit	CANTIER (TXEIE[2:0])

12.5.7.2 Transmit Interrupt

At least one of the three transmit buffers is empty (not scheduled) and can be loaded to schedule a message for transmission. The TXEx flag of the empty message buffer is set.

12.5.7.3 Receive Interrupt

A message is successfully received and shifted into the foreground buffer (RxFG) of the receiver FIFO. This interrupt is generated immediately after receiving the EOF symbol. The RXF flag is set. If there are multiple messages in the receiver FIFO, the RXF flag is set as soon as the next message is shifted to the foreground buffer.

12.5.7.4 Wake-Up Interrupt

A wake-up interrupt is generated if activity on the CAN bus occurs during MSCAN internal sleep mode. WUPE (see [Section 12.3.1](#), “MSCAN Control Register 0 (CANCTL0)”) must be enabled.

12.5.7.5 Error Interrupt

An error interrupt is generated if an overrun of the receiver FIFO, error, warning, or bus-off condition occurs. [Section 12.3.4.1](#), “MSCAN Receiver Flag Register (CANRFLG)” indicates one of the following conditions:

- **Overrun** — An overrun condition of the receiver FIFO as described in [Section 12.5.2.3](#), “Receive Structures,” occurred.
- **CAN Status Change** — The actual value of the transmit and receive error counters control the CAN bus state of the MSCAN. As soon as the error counters skip into a critical range (Tx/Rx-warning, Tx/Rx-error, bus-off) the MSCAN flags an error condition. The status change, which caused the error condition, is indicated by the TSTAT and RSTAT flags (see

Section 12.3.4.1, “MSCAN Receiver Flag Register (CANRFLG)” and Section 12.3.5, “MSCAN Receiver Interrupt Enable Register (CANRIER”).

12.5.7.6 Interrupt Acknowledge

Interrupts are directly associated with one or more status flags in either the Section 12.3.4.1, “MSCAN Receiver Flag Register (CANRFLG)” or the Section 12.3.6, “MSCAN Transmitter Flag Register (CANTFLG).” Interrupts are pending as long as one of the corresponding flags is set. The flags in CANRFLG and CANTFLG must be reset within the interrupt handler to handshake the interrupt. The flags are reset by writing a 1 to the corresponding bit position. A flag cannot be cleared if the respective condition prevails.

NOTE

It must be guaranteed that the CPU clears only the bit causing the current interrupt. For this reason, bit manipulation instructions (BSET) must not be used to clear interrupt flags. These instructions may cause accidental clearing of interrupt flags which are set after entering the current interrupt service routine.

12.5.7.7 Recovery from Stop or Wait

The MSCAN can recover from stop or wait via the wake-up interrupt. This interrupt can only occur if the MSCAN was in sleep mode (SLPRQ = 1 and SLPK = 1) before entering power down mode, the wake-up option is enabled (WUPE = 1), and the wake-up interrupt is enabled (WUPIE = 1).

12.6 Initialization/Application Information

12.6.1 MSCAN initialization

The procedure to initially start up the MSCAN module out of reset is as follows:

1. Assert CANE
2. Write to the configuration registers in initialization mode
3. Clear INTRQ to leave initialization mode and enter normal mode

If the configuration of registers which are writable in initialization mode needs to be changed only when the MSCAN module is in normal mode:

1. Bring the module into sleep mode by setting SLPRQ and awaiting SLPK to assert after the CAN bus becomes idle.
2. Enter initialization mode: assert INTRQ and await INITAK
3. Write to the configuration registers in initialization mode
4. Clear INTRQ to leave initialization mode and continue in normal mode

12.6.2 Bus-Off Recovery

The bus-off recovery is user configurable. The bus-off state can either be exited automatically or on user request.

For reasons of backwards compatibility, the MSCAN defaults to automatic recovery after reset. In this case, the MSCAN will become error active again after counting 128 occurrences of 11 consecutive recessive bits on the CAN bus (See the Bosch CAN specification for details).

If the MSCAN is configured for user request (BORM set in [Section 12.3.2, “MSCAN Control Register 1 \(CANCTL1\)”](#)), the recovery from bus-off starts after both independent events have become true:

- 128 occurrences of 11 consecutive recessive bits on the CAN bus have been monitored
- BOHOLD in [Section 12.3.12, “MSCAN Miscellaneous Register \(CANMISC\)”](#) has been cleared by the user

These two events may occur in any order.

Chapter 13

Serial Peripheral Interface (S08SPIV3)

13.1 Introduction

The serial peripheral interface (SPI) module provides for full-duplex, synchronous, serial communication between the MCU and peripheral devices. These peripheral devices can include other microcontrollers, analog-to-digital converters, shift registers, sensors, memories, etc.

The SPI runs at a baud rate up to the bus clock divided by two in master mode and up to the bus clock divided by four in slave mode. Software can poll the status flags, or SPI operation can be interrupt driven.

All MC9S08DZ128 Series MCUs in the 100-pin package have two SPIs; devices in the 64-pin and 48-pin packages have one SPI.

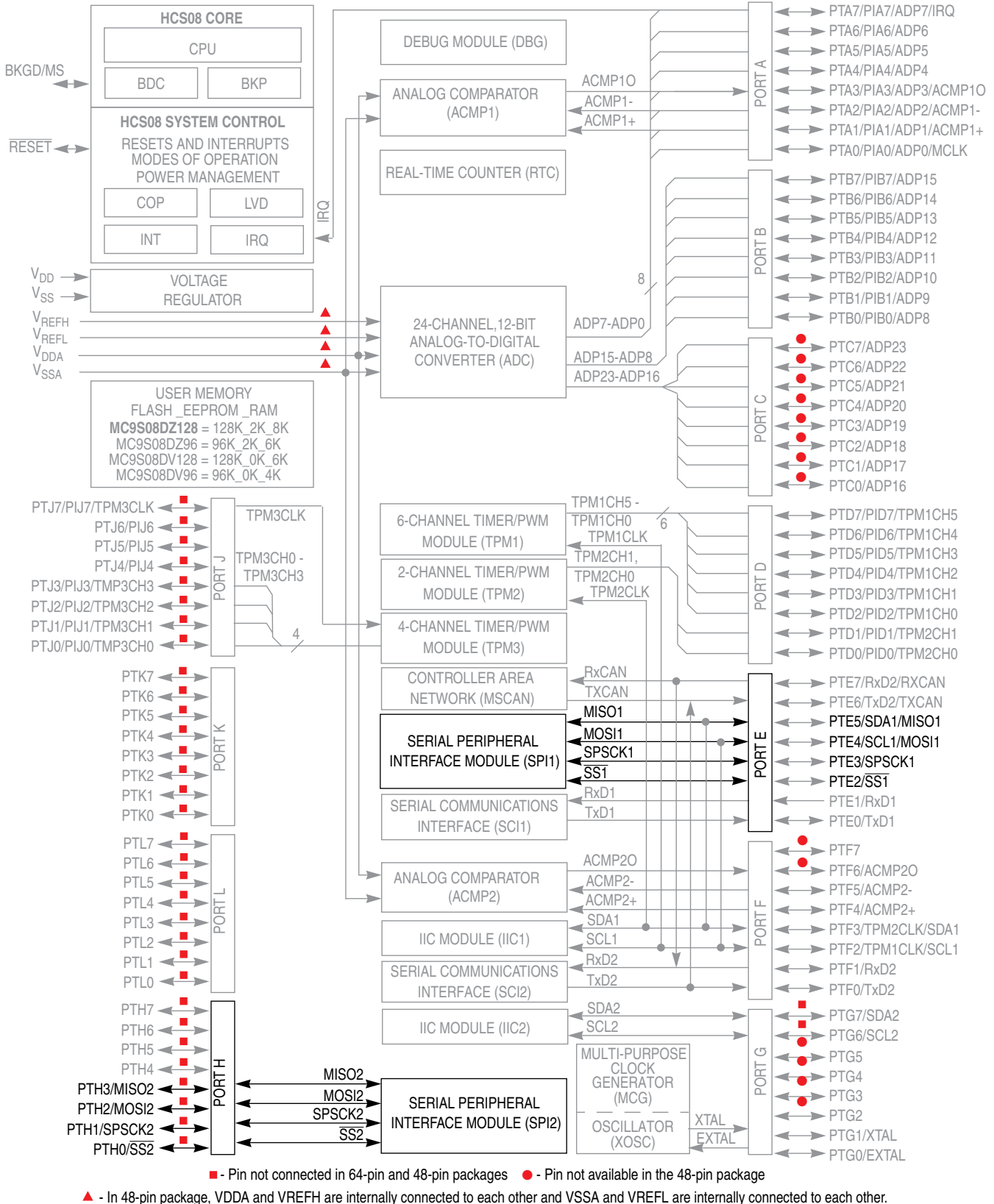

Figure 13-1. MC9S08DZ128 Block Diagram with SPI Highlighted

13.1.1 Features

Features of the SPI module include:

- Master or slave mode operation
- Full-duplex or single-wire bidirectional option
- Programmable transmit bit rate
- Double-buffered transmit and receive
- Serial clock phase and polarity options
- Slave select output
- Selectable MSB-first or LSB-first shifting

13.1.2 Block Diagrams

This section includes block diagrams showing SPI system connections, the internal organization of the SPI module, and the SPI clock dividers that control the master mode bit rate.

13.1.2.1 SPI System Block Diagram

Figure 13-2 shows the SPI modules of two MCUs connected in a master-slave arrangement. The master device initiates all SPI data transfers. During a transfer, the master shifts data out (on the MOSI pin) to the slave while simultaneously shifting data in (on the MISO pin) from the slave. The transfer effectively exchanges the data that was in the SPI shift registers of the two SPI systems. The SPSCCK signal is a clock output from the master and an input to the slave. The slave device must be selected by a low level on the slave select input (\overline{SS} pin). In this system, the master device has configured its \overline{SS} pin as an optional slave select output.

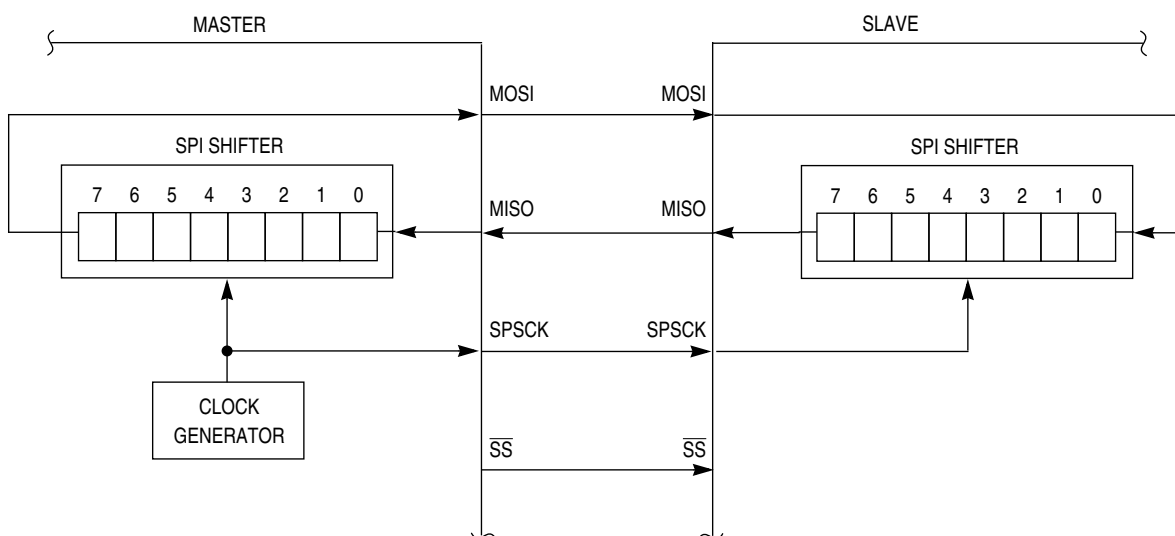

Figure 13-2. SPI System Connections

The most common uses of the SPI system include connecting simple shift registers for adding input or output ports or connecting small peripheral devices such as serial A/D or D/A converters. Although [Figure 13-2](#) shows a system where data is exchanged between two MCUs, many practical systems involve simpler connections where data is unidirectionally transferred from the master MCU to a slave or from a slave to the master MCU.

13.1.2.2 SPI Module Block Diagram

[Figure 13-3](#) is a block diagram of the SPI module. The central element of the SPI is the SPI shift register. Data is written to the double-buffered transmitter (write to SPIxD) and gets transferred to the SPI shift register at the start of a data transfer. After shifting in a byte of data, the data is transferred into the double-buffered receiver where it can be read (read from SPIxD). Pin multiplexing logic controls connections between MCU pins and the SPI module.

When the SPI is configured as a master, the clock output is routed to the SPSCCK pin, the shifter output is routed to MOSI, and the shifter input is routed from the MISO pin.

When the SPI is configured as a slave, the SPSCCK pin is routed to the clock input of the SPI, the shifter output is routed to MISO, and the shifter input is routed from the MOSI pin.

In the external SPI system, simply connect all SPSCCK pins to each other, all MISO pins together, and all MOSI pins together. Peripheral devices often use slightly different names for these pins.

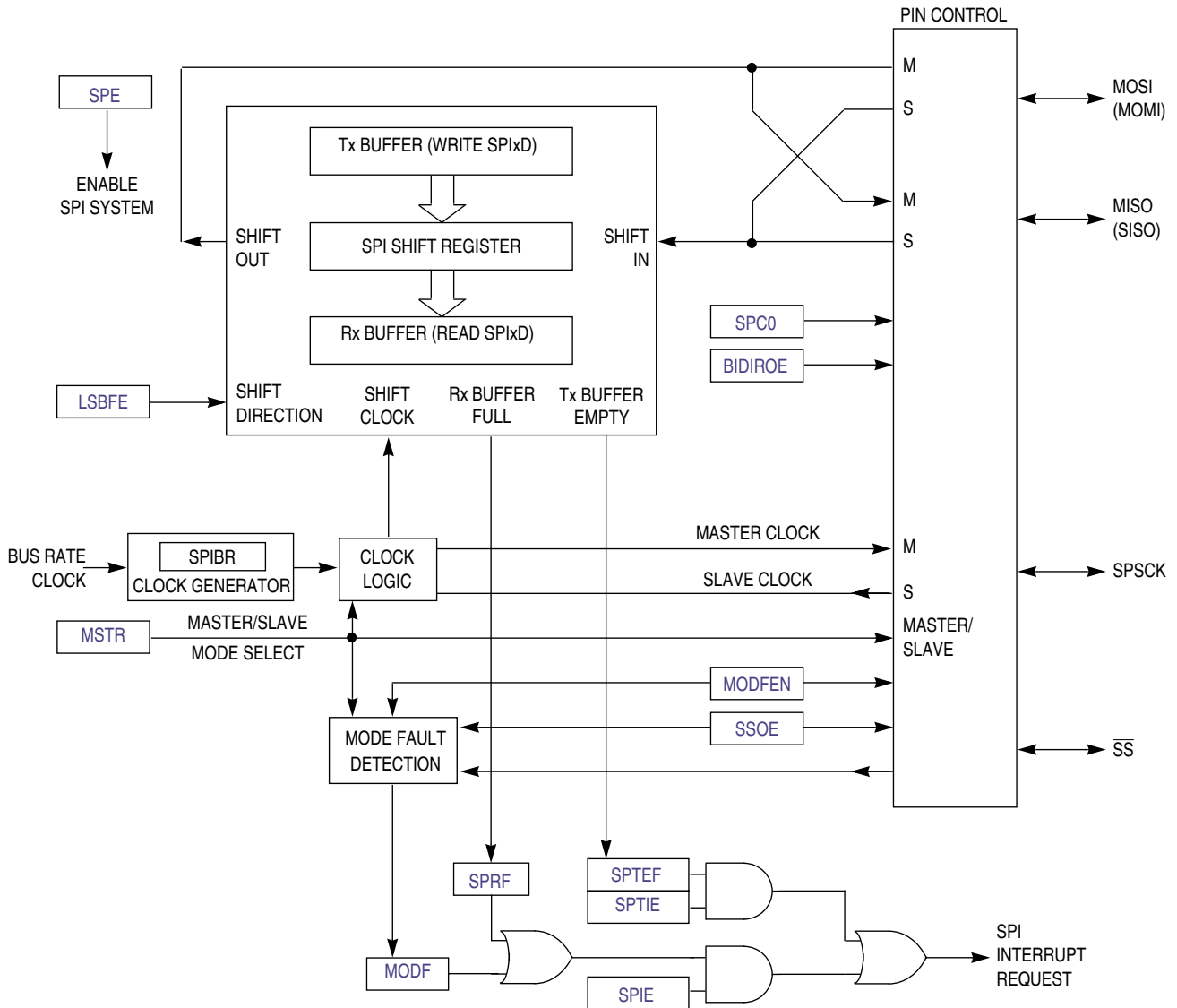

Figure 13-3. SPI Module Block Diagram

13.1.3 SPI Baud Rate Generation

As shown in Figure 13-4, the clock source for the SPI baud rate generator is the bus clock. The three prescale bits (SPPR2:SPPR1:SPPR0) choose a prescale divisor of 1, 2, 3, 4, 5, 6, 7, or 8. The three rate select bits (SPR2:SPR1:SPR0) divide the output of the prescaler stage by 2, 4, 8, 16, 32, 64, 128, or 256 to get the internal SPI master mode bit-rate clock.

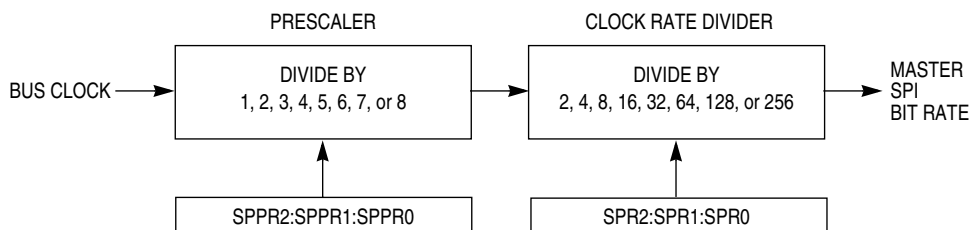

Figure 13-4. SPI Baud Rate Generation

13.2 External Signal Description

The SPI optionally shares four port pins. The function of these pins depends on the settings of SPI control bits. When the SPI is disabled ($SPE = 0$), these four pins revert to being general-purpose port I/O pins that are not controlled by the SPI.

13.2.1 SPCK — SPI Serial Clock

When the SPI is enabled as a slave, this pin is the serial clock input. When the SPI is enabled as a master, this pin is the serial clock output.

13.2.2 MOSI — Master Data Out, Slave Data In

When the SPI is enabled as a master and SPI pin control zero ($SPC0$) is 0 (not bidirectional mode), this pin is the serial data output. When the SPI is enabled as a slave and $SPC0 = 0$, this pin is the serial data input. If $SPC0 = 1$ to select single-wire bidirectional mode, and master mode is selected, this pin becomes the bidirectional data I/O pin (MOMI). Also, the bidirectional mode output enable bit determines whether the pin acts as an input ($BIDIROE = 0$) or an output ($BIDIROE = 1$). If $SPC0 = 1$ and slave mode is selected, this pin is not used by the SPI and reverts to being a general-purpose port I/O pin.

13.2.3 MISO — Master Data In, Slave Data Out

When the SPI is enabled as a master and SPI pin control zero ($SPC0$) is 0 (not bidirectional mode), this pin is the serial data input. When the SPI is enabled as a slave and $SPC0 = 0$, this pin is the serial data output. If $SPC0 = 1$ to select single-wire bidirectional mode, and slave mode is selected, this pin becomes the bidirectional data I/O pin (SISO) and the bidirectional mode output enable bit determines whether the pin acts as an input ($BIDIROE = 0$) or an output ($BIDIROE = 1$). If $SPC0 = 1$ and master mode is selected, this pin is not used by the SPI and reverts to being a general-purpose port I/O pin.

13.2.4 \overline{SS} — Slave Select

When the SPI is enabled as a slave, this pin is the low-true slave select input. When the SPI is enabled as a master and mode fault enable is off ($MODFEN = 0$), this pin is not used by the SPI and reverts to being a general-purpose port I/O pin. When the SPI is enabled as a master and $MODFEN = 1$, the slave select output enable bit determines whether this pin acts as the mode fault input ($SSOE = 0$) or as the slave select output ($SSOE = 1$).

13.3 Modes of Operation

13.3.1 SPI in Stop Modes

The SPI is disabled in all stop modes, regardless of the settings before executing the STOP instruction. During either stop1 or stop2 mode, the SPI module will be fully powered down. Upon wake-up from stop1 or stop2 mode, the SPI module will be in the reset state. During stop3 mode, clocks to the SPI module are halted. No registers are affected. If stop3 is exited with a reset, the SPI will be put into its reset state. If stop3 is exited with an interrupt, the SPI continues from the state it was in when stop3 was entered.

13.4 Register Definition

The SPI has five 8-bit registers to select SPI options, control baud rate, report SPI status, and for transmit/receive data.

Refer to the direct-page register summary in the [Memory](#) chapter of this data sheet for the absolute address assignments for all SPI registers. This section refers to registers and control bits only by their names, and a Freescale-provided equate or header file is used to translate these names into the appropriate absolute addresses.

13.4.1 SPI Control Register 1 (SPIxC1)

This read/write register includes the SPI enable control, interrupt enables, and configuration options.

	7	6	5	4	3	2	1	0
R	SPIE	SPE	SPTIE	MSTR	CPOL	CPHA	SSOE	LSBFE
W								
Reset	0	0	0	0	0	1	0	0

Figure 13-5. SPI Control Register 1 (SPIxC1)

Table 13-1. SPIxC1 Field Descriptions

Field	Description
7 SPIE	SPI Interrupt Enable (for SPRF and MODF) — This is the interrupt enable for SPI receive buffer full (SPRF) and mode fault (MODF) events. 0 Interrupts from SPRF and MODF inhibited (use polling) 1 When SPRF or MODF is 1, request a hardware interrupt
6 SPE	SPI System Enable — Disabling the SPI halts any transfer that is in progress, clears data buffers, and initializes internal state machines. SPRF is cleared and SPTEF is set to indicate the SPI transmit data buffer is empty. 0 SPI system inactive 1 SPI system enabled
5 SPTIE	SPI Transmit Interrupt Enable — This is the interrupt enable bit for SPI transmit buffer empty (SPTEF). 0 Interrupts from SPTEF inhibited (use polling) 1 When SPTEF is 1, hardware interrupt requested

Table 13-1. SPIxCI Field Descriptions (continued)

Field	Description
4 MSTR	Master/Slave Mode Select 0 SPI module configured as a slave SPI device 1 SPI module configured as a master SPI device
3 CPOL	Clock Polarity — This bit effectively places an inverter in series with the clock signal from a master SPI or to a slave SPI device. Refer to Section 13.5.1, “SPI Clock Formats” for more details. 0 Active-high SPI clock (idles low) 1 Active-low SPI clock (idles high)
2 CPHA	Clock Phase — This bit selects one of two clock formats for different kinds of synchronous serial peripheral devices. Refer to Section 13.5.1, “SPI Clock Formats” for more details. 0 First edge on SPSCCK occurs at the middle of the first cycle of an 8-cycle data transfer 1 First edge on SPSCCK occurs at the start of the first cycle of an 8-cycle data transfer
1 SSOE	Slave Select Output Enable — This bit is used in combination with the mode fault enable (MODFEN) bit in SPCR2 and the master/slave (MSTR) control bit to determine the function of the \overline{SS} pin as shown in Table 13-2 .
0 LSBFE	LSB First (Shifter Direction) 0 SPI serial data transfers start with most significant bit 1 SPI serial data transfers start with least significant bit

Table 13-2. \overline{SS} Pin Function

MODFEN	SSOE	Master Mode	Slave Mode
0	0	General-purpose I/O (not SPI)	Slave select input
0	1	General-purpose I/O (not SPI)	Slave select input
1	0	\overline{SS} input for mode fault	Slave select input
1	1	Automatic \overline{SS} output	Slave select input

NOTE

Ensure that the SPI should not be disabled (SPE=0) at the same time as a bit change to the CPHA bit. These changes should be performed as separate operations or unexpected behavior may occur.

13.4.2 SPI Control Register 2 (SPIxCI2)

This read/write register is used to control optional features of the SPI system. Bits 7, 6, 5, and 2 are not implemented and always read 0.

	7	6	5	4	3	2	1	0
R	0	0	0	MODFEN	BIDIROE	0	SPISWAI	SPC0
W								
Reset	0	0	0	0	0	0	0	0

= Unimplemented or Reserved

Figure 13-6. SPI Control Register 2 (SPIxCI2)

Table 13-3. SPIx2 Register Field Descriptions

Field	Description
4 MODFEN	Master Mode-Fault Function Enable — When the SPI is configured for slave mode, this bit has no meaning or effect. (The \overline{SS} pin is the slave select input.) In master mode, this bit determines how the \overline{SS} pin is used (refer to Table 13-2 for more details). 0 Mode fault function disabled, master \overline{SS} pin reverts to general-purpose I/O not controlled by SPI 1 Mode fault function enabled, master \overline{SS} pin acts as the mode fault input or the slave select output
3 BIDIROE	Bidirectional Mode Output Enable — When bidirectional mode is enabled by SPI pin control 0 (SPC0) = 1, BIDIROE determines whether the SPI data output driver is enabled to the single bidirectional SPI I/O pin. Depending on whether the SPI is configured as a master or a slave, it uses either the MOSI (MOMI) or MISO (SISO) pin, respectively, as the single SPI data I/O pin. When SPC0 = 0, BIDIROE has no meaning or effect. 0 Output driver disabled so SPI data I/O pin acts as an input 1 SPI I/O pin enabled as an output
1 SPISWAI	SPI Stop in Wait Mode 0 SPI clocks continue to operate in wait mode 1 SPI clocks stop when the MCU enters wait mode
0 SPC0	SPI Pin Control 0 — The SPC0 bit chooses single-wire bidirectional mode. If MSTR = 0 (slave mode), the SPI uses the MISO (SISO) pin for bidirectional SPI data transfers. If MSTR = 1 (master mode), the SPI uses the MOSI (MOMI) pin for bidirectional SPI data transfers. When SPC0 = 1, BIDIROE is used to enable or disable the output driver for the single bidirectional SPI I/O pin. 0 SPI uses separate pins for data input and data output 1 SPI configured for single-wire bidirectional operation

13.4.3 SPI Baud Rate Register (SPIxBR)

This register is used to set the prescaler and bit rate divisor for an SPI master. This register may be read or written at any time.

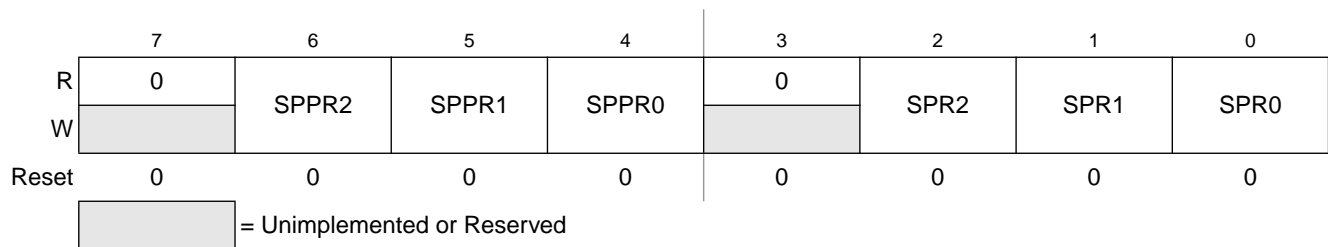
Figure 13-7. SPI Baud Rate Register (SPIxBR)
Table 13-4. SPIxBR Register Field Descriptions

Field	Description
6:4 SPPR[2:0]	SPI Baud Rate Prescale Divisor — This 3-bit field selects one of eight divisors for the SPI baud rate prescaler as shown in Table 13-5. The input to this prescaler is the bus rate clock (BUSCLK). The output of this prescaler drives the input of the SPI baud rate divider (see Figure 13-4).
2:0 SPR[2:0]	SPI Baud Rate Divisor — This 3-bit field selects one of eight divisors for the SPI baud rate divider as shown in Table 13-6. The input to this divider comes from the SPI baud rate prescaler (see Figure 13-4). The output of this divider is the SPI bit rate clock for master mode.

Table 13-5. SPI Baud Rate Prescaler Divisor

SPPR2:SPPR1:SPPR0	Prescaler Divisor
0:0:0	1
0:0:1	2
0:1:0	3
0:1:1	4
1:0:0	5
1:0:1	6
1:1:0	7
1:1:1	8

Table 13-6. SPI Baud Rate Divisor

SPR2:SPR1:SPR0	Rate Divisor
0:0:0	2
0:0:1	4
0:1:0	8
0:1:1	16
1:0:0	32
1:0:1	64
1:1:0	128
1:1:1	256

13.4.4 SPI Status Register (SPIxS)

This register has three read-only status bits. Bits 6, 3, 2, 1, and 0 are not implemented and always read 0. Writes have no meaning or effect.

	7	6	5	4	3	2	1	0
R	SPRF	0	SPTEF	MODF	0	0	0	0
W								
Reset	0	0	1	0	0	0	0	0

= Unimplemented or Reserved

Figure 13-8. SPI Status Register (SPIxS)

Table 13-7. SPIxS Register Field Descriptions

Field	Description
7 SPRF	<p>SPI Read Buffer Full Flag — SPRF is set at the completion of an SPI transfer to indicate that received data may be read from the SPI data register (SPIxD). SPRF is cleared by reading SPRF while it is set, then reading the SPI data register.</p> <p>0 No data available in the receive data buffer 1 Data available in the receive data buffer</p>
5 SPTEF	<p>SPI Transmit Buffer Empty Flag — This bit is set when there is room in the transmit data buffer. It is cleared by reading SPIxS with SPTEF set, followed by writing a data value to the transmit buffer at SPIxD. SPIxS must be read with SPTEF = 1 before writing data to SPIxD or the SPIxD write will be ignored. SPTEF generates an SPTEF CPU interrupt request if the SPTIE bit in the SPIxC1 is also set. SPTEF is automatically set when a data byte transfers from the transmit buffer into the transmit shift register. For an idle SPI (no data in the transmit buffer or the shift register and no transfer in progress), data written to SPIxD is transferred to the shifter almost immediately so SPTEF is set within two bus cycles allowing a second 8-bit data value to be queued into the transmit buffer. After completion of the transfer of the value in the shift register, the queued value from the transmit buffer will automatically move to the shifter and SPTEF will be set to indicate there is room for new data in the transmit buffer. If no new data is waiting in the transmit buffer, SPTEF simply remains set and no data moves from the buffer to the shifter.</p> <p>0 SPI transmit buffer not empty 1 SPI transmit buffer empty</p>
4 MODF	<p>Master Mode Fault Flag — MODF is set if the SPI is configured as a master and the slave select input goes low, indicating some other SPI device is also configured as a master. The \overline{SS} pin acts as a mode fault error input only when MSTR = 1, MODFEN = 1, and SSOE = 0; otherwise, MODF will never be set. MODF is cleared by reading MODF while it is 1, then writing to SPI control register 1 (SPIxC1).</p> <p>0 No mode fault error 1 Mode fault error detected</p>

13.4.5 SPI Data Register (SPIxD)

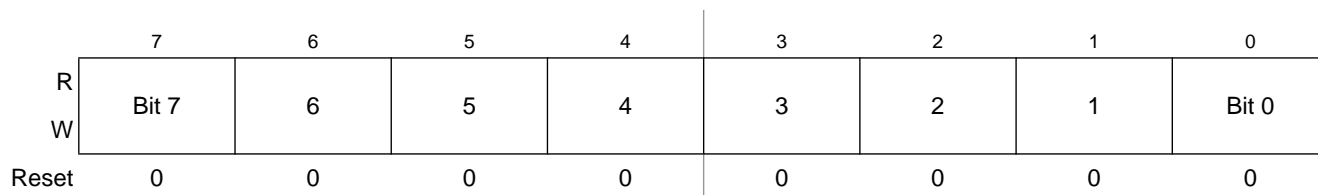

Figure 13-9. SPI Data Register (SPIxD)

Reads of this register return the data read from the receive data buffer. Writes to this register write data to the transmit data buffer. When the SPI is configured as a master, writing data to the transmit data buffer initiates an SPI transfer.

Data should not be written to the transmit data buffer unless the SPI transmit buffer empty flag (SPTEF) is set, indicating there is room in the transmit buffer to queue a new transmit byte.

Data may be read from SPIxD any time after SPRF is set and before another transfer is finished. Failure to read the data out of the receive data buffer before a new transfer ends causes a receive overrun condition and the data from the new transfer is lost.

13.5 Functional Description

An SPI transfer is initiated by checking for the SPI transmit buffer empty flag (SPTEF = 1) and then writing a byte of data to the SPI data register (SPIxD) in the master SPI device. When the SPI shift register is available, this byte of data is moved from the transmit data buffer to the shifter, SPTEF is set to indicate there is room in the buffer to queue another transmit character if desired, and the SPI serial transfer starts.

During the SPI transfer, data is sampled (read) on the MISO pin at one SPSCCK edge and shifted, changing the bit value on the MOSI pin, one-half SPSCCK cycle later. After eight SPSCCK cycles, the data that was in the shift register of the master has been shifted out the MOSI pin to the slave while eight bits of data were shifted in the MISO pin into the master's shift register. At the end of this transfer, the received data byte is moved from the shifter into the receive data buffer and SPRF is set to indicate the data can be read by reading SPIxD. If another byte of data is waiting in the transmit buffer at the end of a transfer, it is moved into the shifter, SPTEF is set, and a new transfer is started.

Normally, SPI data is transferred most significant bit (MSB) first. If the least significant bit first enable (LSBFE) bit is set, SPI data is shifted LSB first.

When the SPI is configured as a slave, its \overline{SS} pin must be driven low before a transfer starts and \overline{SS} must stay low throughout the transfer. If a clock format where CPHA = 0 is selected, \overline{SS} must be driven to a logic 1 between successive transfers. If CPHA = 1, \overline{SS} may remain low between successive transfers. See [Section 13.5.1, "SPI Clock Formats"](#) for more details.

Because the transmitter and receiver are double buffered, a second byte, in addition to the byte currently being shifted out, can be queued into the transmit data buffer, and a previously received character can be in the receive data buffer while a new character is being shifted in. The SPTEF flag indicates when the transmit buffer has room for a new character. The SPRF flag indicates when a received character is available in the receive data buffer. The received character must be read out of the receive buffer (read SPIxD) before the next transfer is finished or a receive overrun error results.

In the case of a receive overrun, the new data is lost because the receive buffer still held the previous character and was not ready to accept the new data. There is no indication for such an overrun condition so the application system designer must ensure that previous data has been read from the receive buffer before a new transfer is initiated.

13.5.1 SPI Clock Formats

To accommodate a wide variety of synchronous serial peripherals from different manufacturers, the SPI system has a clock polarity (CPOL) bit and a clock phase (CPHA) control bit to select one of four clock formats for data transfers. CPOL selectively inserts an inverter in series with the clock. CPHA chooses between two different clock phase relationships between the clock and data.

[Figure 13-10](#) shows the clock formats when CPHA = 1. At the top of the figure, the eight bit times are shown for reference with bit 1 starting at the first SPSCCK edge and bit 8 ending one-half SPSCCK cycle after the sixteenth SPSCCK edge. The MSB first and LSB first lines show the order of SPI data bits depending on the setting in LSBFE. Both variations of SPSCCK polarity are shown, but only one of these waveforms applies for a specific transfer, depending on the value in CPOL. The SAMPLE IN waveform applies to the MOSI input of a slave or the MISO input of a master. The MOSI waveform applies to the MOSI output

pin from a master and the MISO waveform applies to the MISO output from a slave. The \overline{SS} OUT waveform applies to the slave select output from a master (provided MODFEN and SSOE = 1). The master \overline{SS} output goes to active low one-half SPSCK cycle before the start of the transfer and goes back high at the end of the eighth bit time of the transfer. The \overline{SS} IN waveform applies to the slave select input of a slave.

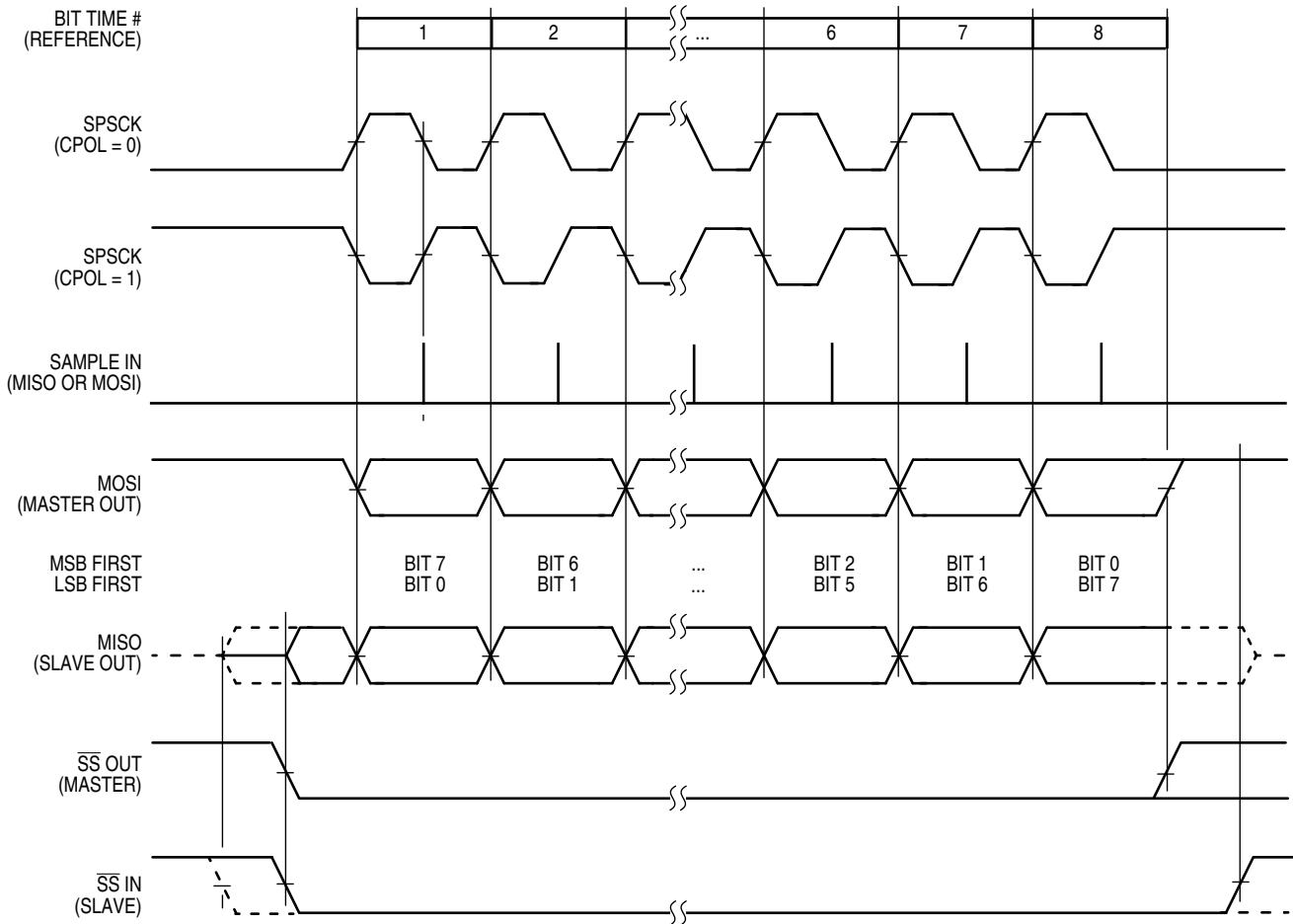

Figure 13-10. SPI Clock Formats (CPHA = 1)

When CPHA = 1, the slave begins to drive its MISO output when \overline{SS} goes to active low, but the data is not defined until the first SPSCK edge. The first SPSCK edge shifts the first bit of data from the shifter onto the MOSI output of the master and the MISO output of the slave. The next SPSCK edge causes both the master and the slave to sample the data bit values on their MISO and MOSI inputs, respectively. At the third SPSCK edge, the SPI shifter shifts one bit position which shifts in the bit value that was just sampled, and shifts the second data bit value out the other end of the shifter to the MOSI and MISO outputs of the master and slave, respectively. When CPHA = 1, the slave's \overline{SS} input is not required to go to its inactive high level between transfers.

Figure 13-11 shows the clock formats when CPHA = 0. At the top of the figure, the eight bit times are shown for reference with bit 1 starting as the slave is selected (\overline{SS} IN goes low), and bit 8 ends at the last SPSCK edge. The MSB first and LSB first lines show the order of SPI data bits depending on the setting

in LSBFE. Both variations of SPSCCK polarity are shown, but only one of these waveforms applies for a specific transfer, depending on the value in CPOL. The SAMPLE IN waveform applies to the MOSI input of a slave or the MISO input of a master. The MOSI waveform applies to the MOSI output pin from a master and the MISO waveform applies to the MISO output from a slave. The \overline{SS} OUT waveform applies to the slave select output from a master (provided MODFEN and SSOE = 1). The master \overline{SS} output goes to active low at the start of the first bit time of the transfer and goes back high one-half SPSCCK cycle after the end of the eighth bit time of the transfer. The \overline{SS} IN waveform applies to the slave select input of a slave.

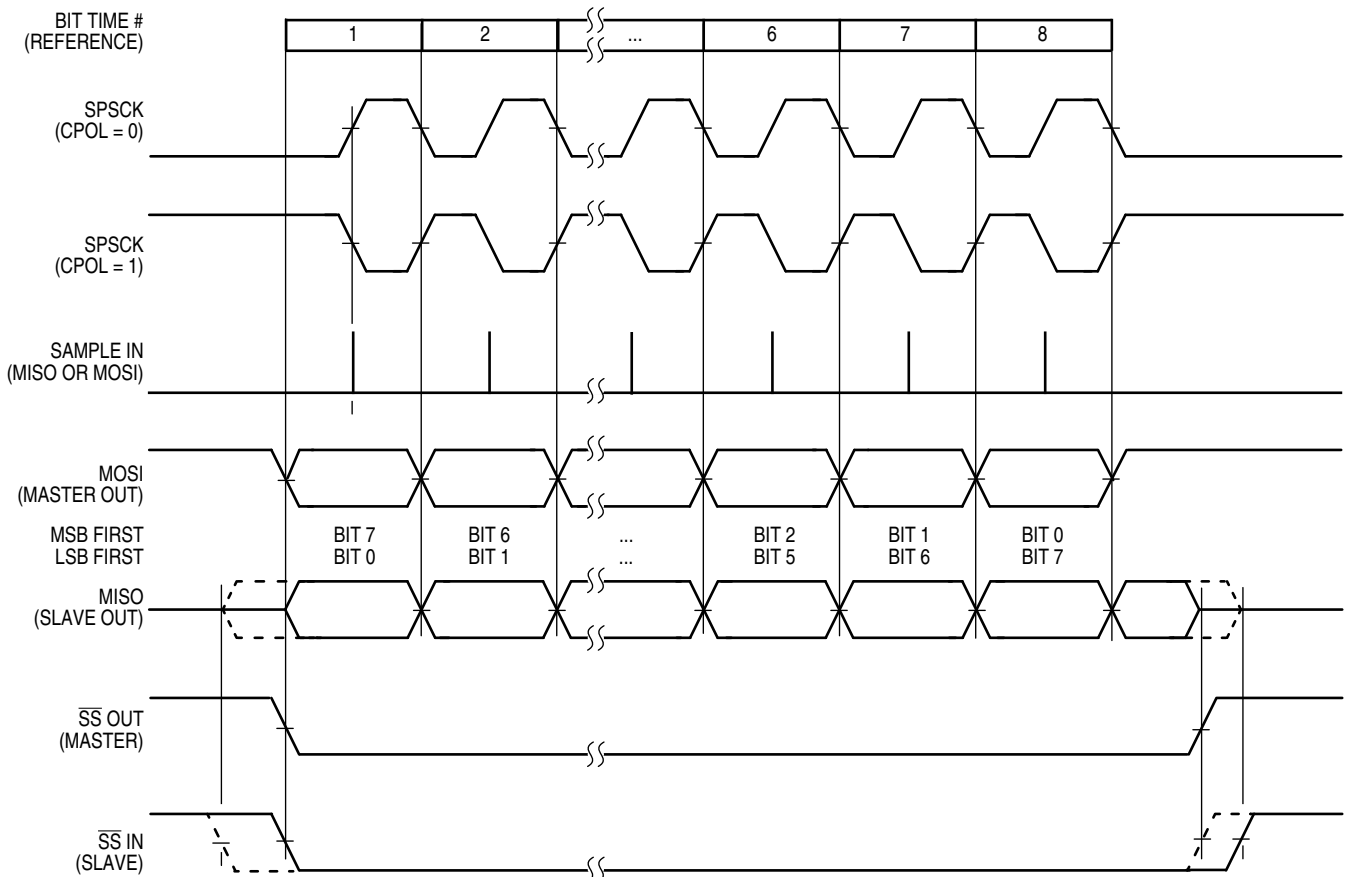

Figure 13-11. SPI Clock Formats (CPHA = 0)

When CPHA = 0, the slave begins to drive its MISO output with the first data bit value (MSB or LSB depending on LSBFE) when \overline{SS} goes to active low. The first SPSCCK edge causes both the master and the slave to sample the data bit values on their MISO and MOSI inputs, respectively. At the second SPSCCK edge, the SPI shifter shifts one bit position which shifts in the bit value that was just sampled and shifts the second data bit value out the other end of the shifter to the MOSI and MISO outputs of the master and slave, respectively. When CPHA = 0, the slave's \overline{SS} input must go to its inactive high level between transfers.

13.5.2 SPI Interrupts

There are three flag bits, two interrupt mask bits, and one interrupt vector associated with the SPI system. The SPI interrupt enable mask (SPIE) enables interrupts from the SPI receiver full flag (SPRF) and mode fault flag (MODF). The SPI transmit interrupt enable mask (SPTIE) enables interrupts from the SPI transmit buffer empty flag (SPTEF). When one of the flag bits is set, and the associated interrupt mask bit is set, a hardware interrupt request is sent to the CPU. If the interrupt mask bits are cleared, software can poll the associated flag bits instead of using interrupts. The SPI interrupt service routine (ISR) should check the flag bits to determine what event caused the interrupt. The service routine should also clear the flag bit(s) before returning from the ISR (usually near the beginning of the ISR).

13.5.3 Mode Fault Detection

A mode fault occurs and the mode fault flag (MODF) becomes set when a master SPI device detects an error on the \overline{SS} pin (provided the \overline{SS} pin is configured as the mode fault input signal). The \overline{SS} pin is configured to be the mode fault input signal when MSTR = 1, mode fault enable is set (MODFEN = 1), and slave select output enable is clear (SSOE = 0).

The mode fault detection feature can be used in a system where more than one SPI device might become a master at the same time. The error is detected when a master's \overline{SS} pin is low, indicating that some other SPI device is trying to address this master as if it were a slave. This could indicate a harmful output driver conflict, so the mode fault logic is designed to disable all SPI output drivers when such an error is detected.

When a mode fault is detected, MODF is set and MSTR is cleared to change the SPI configuration back to slave mode. The output drivers on the SPSCCK, MOSI, and MISO (if not bidirectional mode) are disabled.

MODF is cleared by reading it while it is set, then writing to the SPI control register 1 (SPIxC1). User software should verify the error condition has been corrected before changing the SPI back to master mode.

Chapter 14

Serial Communications Interface (S08SCIV4)

14.1 Introduction

All MCUs in the MC9S08DZ128 Series include SCI1 and SCI2.

NOTE

MC9S08DZ128 Series devices operate at a higher voltage range (2.7 V to 5.5 V) and do not include stop1 mode. Please ignore references to stop1.

14.1.1 SCI2 Configuration Information

The SCI2 module pins, TxD2 and RxD2 can be repositioned under software control using SCI2PS in SOPT1 as shown in [Table 14-1](#). SCI2PS in SOPT1 selects which general-purpose I/O ports are associated with the SCI2 operation.

Table 14-1. SCI2 Position Options

SCI2PS in SOPT1	Port Pin for TXD2	Port Pin for RxD2
0 (default)	PTF0	PTF1
1	PTE6	PTE7

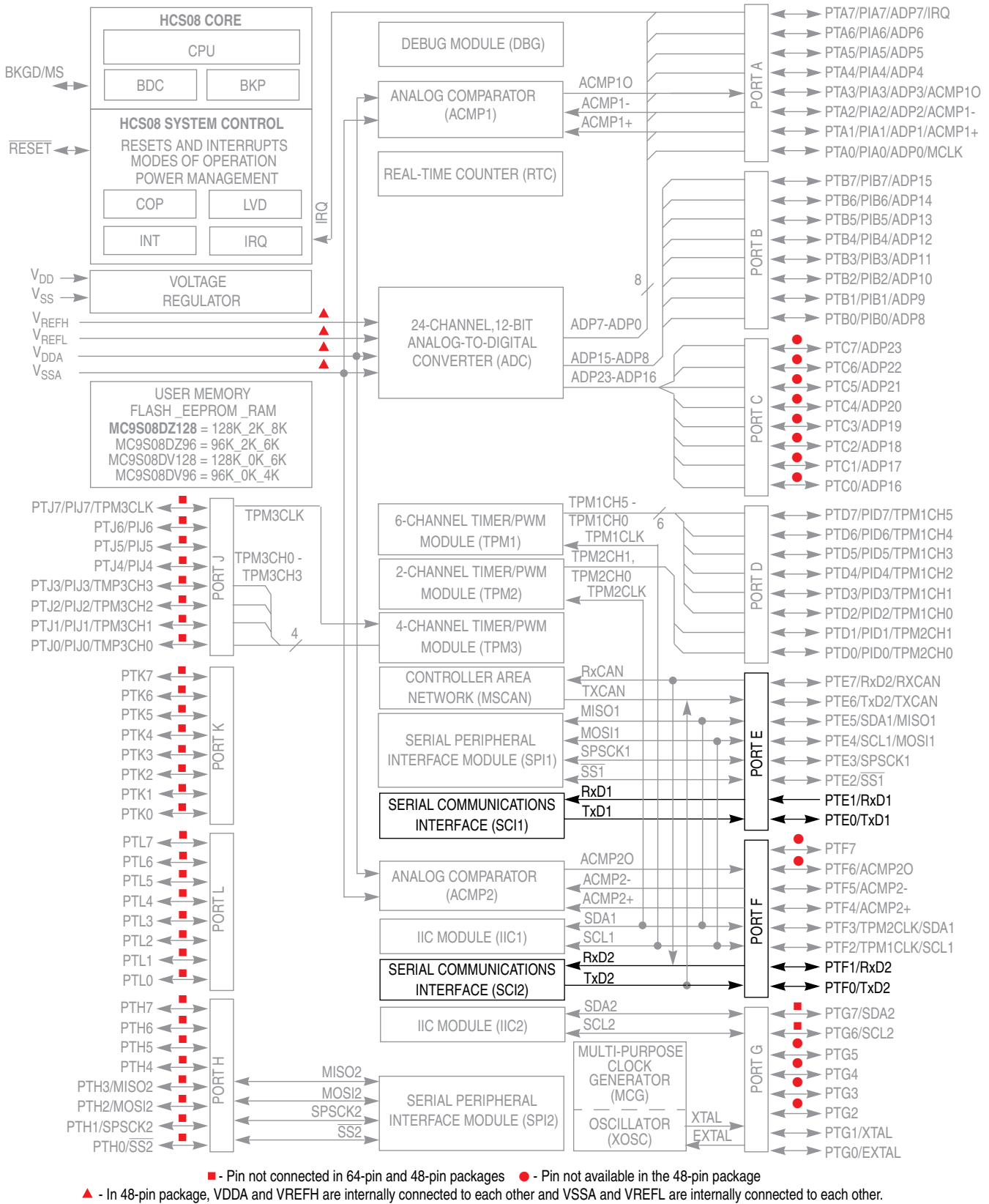

Figure 14-1. MC9S08DZ128 Block Diagram with SCI Highlighted

14.1.2 Features

Features of SCI module include:

- Full-duplex, standard non-return-to-zero (NRZ) format
- Double-buffered transmitter and receiver with separate enables
- Programmable baud rates (13-bit modulo divider)
- Interrupt-driven or polled operation:
 - Transmit data register empty and transmission complete
 - Receive data register full
 - Receive overrun, parity error, framing error, and noise error
 - Idle receiver detect
 - Active edge on receive pin
 - Break detect supporting LIN
- Hardware parity generation and checking
- Programmable 8-bit or 9-bit character length
- Receiver wakeup by idle-line or address-mark
- Optional 13-bit break character generation / 11-bit break character detection
- Selectable transmitter output polarity

14.1.3 Modes of Operation

See [Section 14.3, “Functional Description,”](#) For details concerning SCI operation in these modes:

- 8- and 9-bit data modes
- Stop mode operation
- Loop mode
- Single-wire mode

14.1.4 Block Diagram

Figure 14-2 shows the transmitter portion of the SCI.

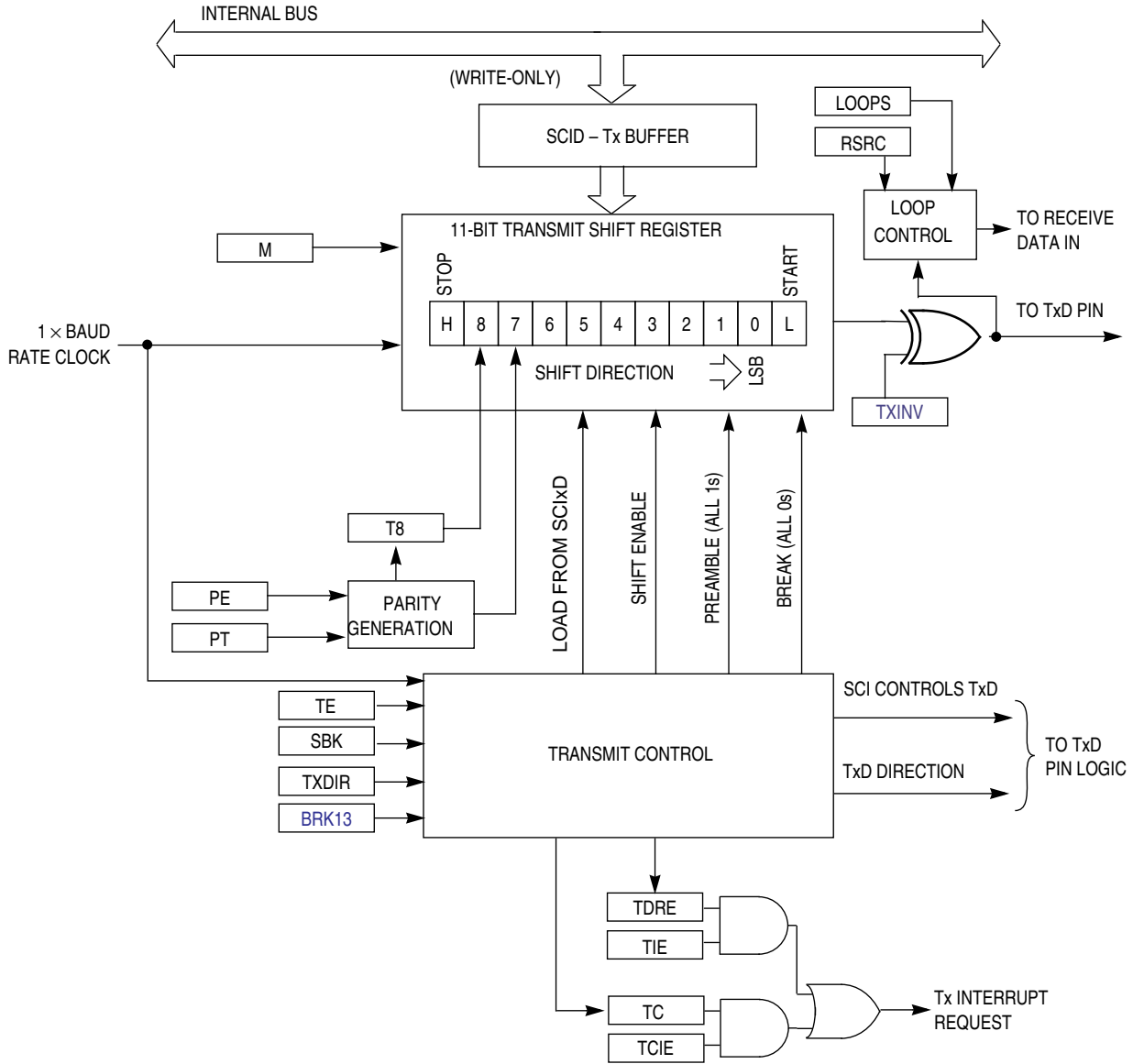

Figure 14-2. SCI Transmitter Block Diagram

Figure 14-3 shows the receiver portion of the SCI.

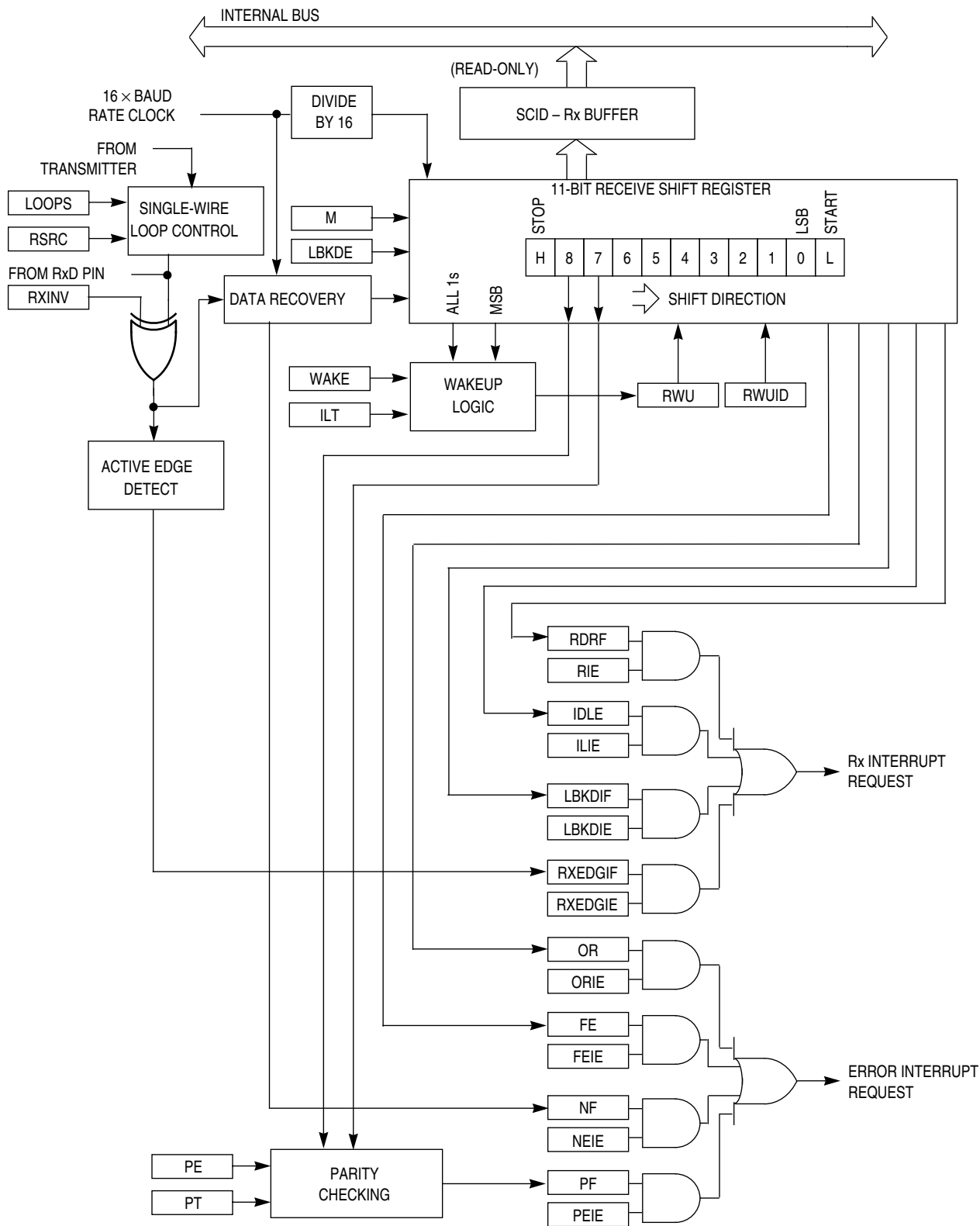

Figure 14-3. SCI Receiver Block Diagram

14.2 Register Definition

The SCI has eight 8-bit registers to control baud rate, select SCI options, report SCI status, and for transmit/receive data.

Refer to the direct-page register summary in the [Memory](#) chapter of this data sheet for the absolute address assignments for all SCI registers. This section refers to registers and control bits only by their names. A Freescale-provided equate or header file is used to translate these names into the appropriate absolute addresses.

14.2.1 SCI Baud Rate Registers (SCIxBDH, SCIxBDL)

This pair of registers controls the prescale divisor for SCI baud rate generation. To update the 13-bit baud rate setting [SBR12:SBR0], first write to SCIxBDH to buffer the high half of the new value and then write to SCIxBDL. The working value in SCIxBDH does not change until SCIxBDL is written.

SCIxBDL is reset to a non-zero value, so after reset the baud rate generator remains disabled until the first time the receiver or transmitter is enabled (RE or TE bits in SCIxC2 are written to 1).

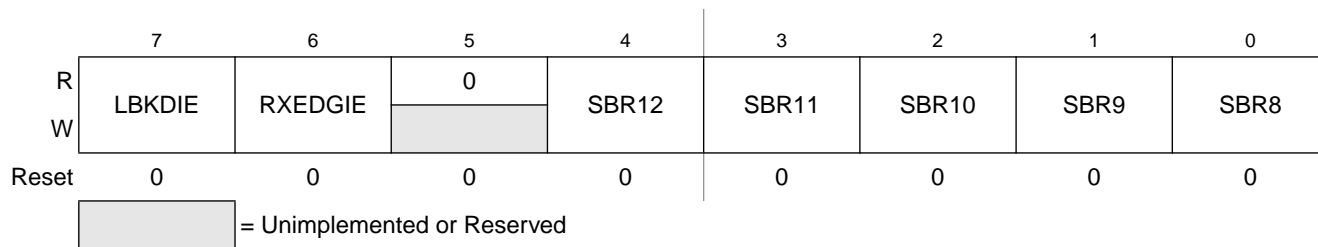

Figure 14-4. SCI Baud Rate Register (SCIxBDH)

Table 14-2. SCIxBDH Field Descriptions

Field	Description
7 LBKDIE	LIN Break Detect Interrupt Enable (for LBKDIF) 0 Hardware interrupts from LBKDIF disabled (use polling). 1 Hardware interrupt requested when LBKDIF flag is 1.
6 RXEDGIE	RxD Input Active Edge Interrupt Enable (for RXEDGIF) 0 Hardware interrupts from RXEDGIF disabled (use polling). 1 Hardware interrupt requested when RXEDGIF flag is 1.
4:0 SBR[12:8]	Baud Rate Modulo Divisor — The 13 bits in SBR[12:0] are referred to collectively as BR, and they set the modulo divide rate for the SCI baud rate generator. When BR = 0, the SCI baud rate generator is disabled to reduce supply current. When BR = 1 to 8191, the SCI baud rate = BUSCLK/(16×BR). See also BR bits in Table 14-3 .

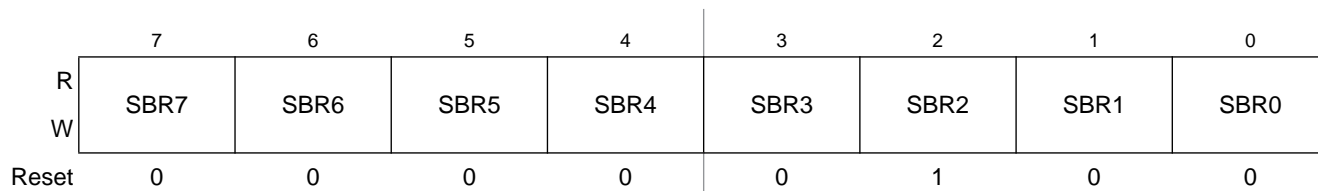

Figure 14-5. SCI Baud Rate Register (SClxBDL)

Table 14-3. SClxBDL Field Descriptions

Field	Description
7:0 SBR[7:0]	Baud Rate Modulo Divisor — These 13 bits in SBR[12:0] are referred to collectively as BR, and they set the modulo divide rate for the SCI baud rate generator. When BR = 0, the SCI baud rate generator is disabled to reduce supply current. When BR = 1 to 8191, the SCI baud rate = $BUSCLK/(16 \times BR)$. See also BR bits in Table 14-2.

14.2.2 SCI Control Register 1 (SClxC1)

This read/write register is used to control various optional features of the SCI system.

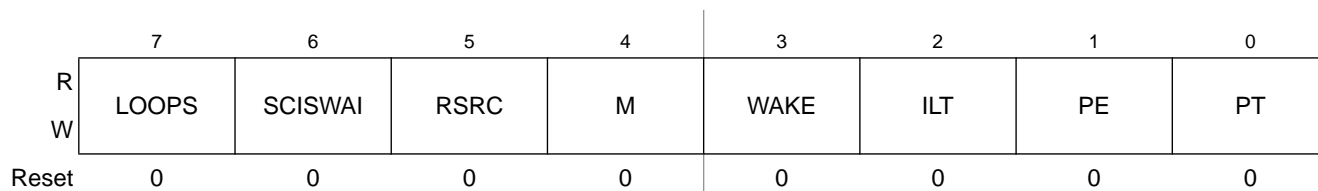

Figure 14-6. SCI Control Register 1 (SClxC1)

Table 14-4. SClxC1 Field Descriptions

Field	Description
7 LOOPS	Loop Mode Select — Selects between loop back modes and normal 2-pin full-duplex modes. When LOOPS = 1, the transmitter output is internally connected to the receiver input. 0 Normal operation — RxD and TxD use separate pins. 1 Loop mode or single-wire mode where transmitter outputs are internally connected to receiver input. (See RSRC bit.) RxD pin is not used by SCI.
6 SCISWAI	SCI Stops in Wait Mode 0 SCI clocks continue to run in wait mode so the SCI can be the source of an interrupt that wakes up the CPU. 1 SCI clocks freeze while CPU is in wait mode.
5 RSRC	Receiver Source Select — This bit has no meaning or effect unless the LOOPS bit is set to 1. When LOOPS = 1, the receiver input is internally connected to the TxD pin and RSRC determines whether this connection is also connected to the transmitter output. 0 Provided LOOPS = 1, RSRC = 0 selects internal loop back mode and the SCI does not use the RxD pins. 1 Single-wire SCI mode where the TxD pin is connected to the transmitter output and receiver input.
4 M	9-Bit or 8-Bit Mode Select 0 Normal — start + 8 data bits (LSB first) + stop. 1 Receiver and transmitter use 9-bit data characters start + 8 data bits (LSB first) + 9th data bit + stop.

Table 14-4. SC1xC1 Field Descriptions (continued)

Field	Description
3 WAKE	Receiver Wakeup Method Select — Refer to Section 14.3.3.2, “Receiver Wakeup Operation” for more information. 0 Idle-line wakeup. 1 Address-mark wakeup.
2 ILT	Idle Line Type Select — Setting this bit to 1 ensures that the stop bit and logic 1 bits at the end of a character do not count toward the 10 or 11 bit times of logic high level needed by the idle line detection logic. Refer to Section 14.3.3.2.1, “Idle-Line Wakeup” for more information. 0 Idle character bit count starts after start bit. 1 Idle character bit count starts after stop bit.
1 PE	Parity Enable — Enables hardware parity generation and checking. When parity is enabled, the most significant bit (MSB) of the data character (eighth or ninth data bit) is treated as the parity bit. 0 No hardware parity generation or checking. 1 Parity enabled.
0 PT	Parity Type — Provided parity is enabled (PE = 1), this bit selects even or odd parity. Odd parity means the total number of 1s in the data character, including the parity bit, is odd. Even parity means the total number of 1s in the data character, including the parity bit, is even. 0 Even parity. 1 Odd parity.

14.2.3 SCI Control Register 2 (SC1xC2)

This register can be read or written at any time.

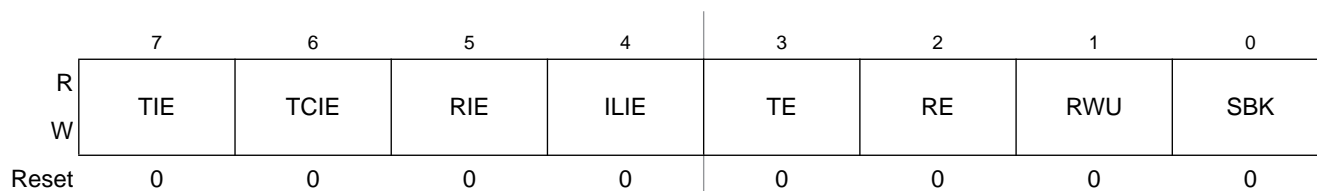
Figure 14-7. SCI Control Register 2 (SC1xC2)
Table 14-5. SC1xC2 Field Descriptions

Field	Description
7 TIE	Transmit Interrupt Enable (for TDRE) 0 Hardware interrupts from TDRE disabled (use polling). 1 Hardware interrupt requested when TDRE flag is 1.
6 TCIE	Transmission Complete Interrupt Enable (for TC) 0 Hardware interrupts from TC disabled (use polling). 1 Hardware interrupt requested when TC flag is 1.
5 RIE	Receiver Interrupt Enable (for RDRF) 0 Hardware interrupts from RDRF disabled (use polling). 1 Hardware interrupt requested when RDRF flag is 1.
4 ILIE	Idle Line Interrupt Enable (for IDLE) 0 Hardware interrupts from IDLE disabled (use polling). 1 Hardware interrupt requested when IDLE flag is 1.

Table 14-5. SCIxC2 Field Descriptions (continued)

Field	Description
3 TE	Transmitter Enable 0 Transmitter off. 1 Transmitter on. TE must be 1 in order to use the SCI transmitter. When TE = 1, the SCI forces the TxD pin to act as an output for the SCI system. When the SCI is configured for single-wire operation (LOOPS = RSRC = 1), TXDIR controls the direction of traffic on the single SCI communication line (TxD pin). TE also can be used to queue an idle character by writing TE = 0 then TE = 1 while a transmission is in progress. Refer to Section 14.3.2.1, “Send Break and Queued Idle” for more details. When TE is written to 0, the transmitter keeps control of the port TxD pin until any data, queued idle, or queued break character finishes transmitting before allowing the pin to revert to a general-purpose I/O pin.
2 RE	Receiver Enable — When the SCI receiver is off, the RxD pin reverts to being a general-purpose port I/O pin. If LOOPS = 1 the RxD pin reverts to being a general-purpose I/O pin even if RE = 1. 0 Receiver off. 1 Receiver on.
1 RWU	Receiver Wakeup Control — This bit can be written to 1 to place the SCI receiver in a standby state where it waits for automatic hardware detection of a selected wakeup condition. The wakeup condition is either an idle line between messages (WAKE = 0, idle-line wakeup), or a logic 1 in the most significant data bit in a character (WAKE = 1, address-mark wakeup). Application software sets RWU and (normally) a selected hardware condition automatically clears RWU. Refer to Section 14.3.3.2, “Receiver Wakeup Operation” for more details. 0 Normal SCI receiver operation. 1 SCI receiver in standby waiting for wakeup condition.
0 SBK	Send Break — Writing a 1 and then a 0 to SBK queues a break character in the transmit data stream. Additional break characters of 10 or 11 (13 or 14 if BRK13 = 1) bit times of logic 0 are queued as long as SBK = 1. Depending on the timing of the set and clear of SBK relative to the information currently being transmitted, a second break character may be queued before software clears SBK. Refer to Section 14.3.2.1, “Send Break and Queued Idle” for more details. 0 Normal transmitter operation. 1 Queue break character(s) to be sent.

14.2.4 SCI Status Register 1 (SCIxS1)

This register has eight read-only status flags. Writes have no effect. Special software sequences (which do not involve writing to this register) are used to clear these status flags.

	7	6	5	4	3	2	1	0
R	TDRE	TC	RDRF	IDLE	OR	NF	FE	PF
W								
Reset	1	1	0	0	0	0	0	0

 = Unimplemented or Reserved

Figure 14-8. SCI Status Register 1 (SCIxS1)

Table 14-6. SC1xS1 Field Descriptions

Field	Description
7 TDRE	<p>Transmit Data Register Empty Flag — TDRE is set out of reset and when a transmit data value transfers from the transmit data buffer to the transmit shifter, leaving room for a new character in the buffer. To clear TDRE, read SC1xS1 with TDRE = 1 and then write to the SCI data register (SC1xD).</p> <p>0 Transmit data register (buffer) full. 1 Transmit data register (buffer) empty.</p>
6 TC	<p>Transmission Complete Flag — TC is set out of reset and when TDRE = 1 and no data, preamble, or break character is being transmitted.</p> <p>0 Transmitter active (sending data, a preamble, or a break). 1 Transmitter idle (transmission activity complete).</p> <p>TC is cleared automatically by reading SC1xS1 with TC = 1 and then doing one of the following three things:</p> <ul style="list-style-type: none"> • Write to the SCI data register (SC1xD) to transmit new data • Queue a preamble by changing TE from 0 to 1 • Queue a break character by writing 1 to SBK in SC1xC2
5 RDRF	<p>Receive Data Register Full Flag — RDRF becomes set when a character transfers from the receive shifter into the receive data register (SC1xD). To clear RDRF, read SC1xD with RDRF = 1 and then read the SCI data register (SC1xD).</p> <p>0 Receive data register empty. 1 Receive data register full.</p>
4 IDLE	<p>Idle Line Flag — IDLE is set when the SCI receive line becomes idle for a full character time after a period of activity. When ILT = 0, the receiver starts counting idle bit times after the start bit. So if the receive character is all 1s, these bit times and the stop bit time count toward the full character time of logic high (10 or 11 bit times depending on the M control bit) needed for the receiver to detect an idle line. When ILT = 1, the receiver doesn't start counting idle bit times until after the stop bit. So the stop bit and any logic high bit times at the end of the previous character do not count toward the full character time of logic high needed for the receiver to detect an idle line.</p> <p>To clear IDLE, read SC1xS1 with IDLE = 1 and then read the SCI data register (SC1xD). After IDLE has been cleared, it cannot become set again until after a new character has been received and RDRF has been set. IDLE will get set only once even if the receive line remains idle for an extended period.</p> <p>0 No idle line detected. 1 Idle line was detected.</p>
3 OR	<p>Receiver Overrun Flag — OR is set when a new serial character is ready to be transferred to the receive data register (buffer), but the previously received character has not been read from SC1xD yet. In this case, the new character (and all associated error information) is lost because there is no room to move it into SC1xD. To clear OR, read SC1xS1 with OR = 1 and then read the SCI data register (SC1xD).</p> <p>0 No overrun. 1 Receive overrun (new SCI data lost).</p>
2 NF	<p>Noise Flag — The advanced sampling technique used in the receiver takes seven samples during the start bit and three samples in each data bit and the stop bit. If any of these samples disagrees with the rest of the samples within any bit time in the frame, the flag NF will be set at the same time as the flag RDRF gets set for the character. To clear NF, read SC1xS1 and then read the SCI data register (SC1xD).</p> <p>0 No noise detected. 1 Noise detected in the received character in SC1xD.</p>

Table 14-6. SC1xS1 Field Descriptions (continued)

Field	Description
1 FE	Framing Error Flag — FE is set at the same time as RDRF when the receiver detects a logic 0 where the stop bit was expected. This suggests the receiver was not properly aligned to a character frame. To clear FE, read SC1xS1 with FE = 1 and then read the SCI data register (SCIxD). 0 No framing error detected. This does not guarantee the framing is correct. 1 Framing error.
0 PF	Parity Error Flag — PF is set at the same time as RDRF when parity is enabled (PE = 1) and the parity bit in the received character does not agree with the expected parity value. To clear PF, read SC1xS1 and then read the SCI data register (SCIxD). 0 No parity error. 1 Parity error.

14.2.5 SCI Status Register 2 (SC1xS2)

This register has one read-only status flag.

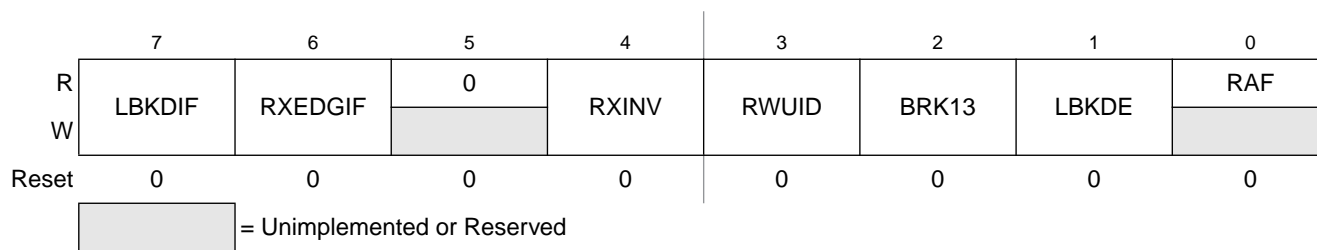
Figure 14-9. SCI Status Register 2 (SC1xS2)
Table 14-7. SC1xS2 Field Descriptions

Field	Description
7 LBKDIF	LIN Break Detect Interrupt Flag — LBKDIF is set when the LIN break detect circuitry is enabled and a LIN break character is detected. LBKDIF is cleared by writing a “1” to it. 0 No LIN break character has been detected. 1 LIN break character has been detected.
6 RXEDGIF	RxD Pin Active Edge Interrupt Flag — RXEDGIF is set when an active edge (falling if RXINV = 0, rising if RXINV=1) on the RxD pin occurs. RXEDGIF is cleared by writing a “1” to it. 0 No active edge on the receive pin has occurred. 1 An active edge on the receive pin has occurred.
4 RXINV ¹	Receive Data Inversion — Setting this bit reverses the polarity of the received data input. 0 Receive data not inverted 1 Receive data inverted
3 RWUID	Receive Wake Up Idle Detect — RWUID controls whether the idle character that wakes up the receiver sets the IDLE bit. 0 During receive standby state (RWU = 1), the IDLE bit does not get set upon detection of an idle character. 1 During receive standby state (RWU = 1), the IDLE bit gets set upon detection of an idle character.
2 BRK13	Break Character Generation Length — BRK13 is used to select a longer transmitted break character length. Detection of a framing error is not affected by the state of this bit. 0 Break character is transmitted with length of 10 bit times (11 if M = 1) 1 Break character is transmitted with length of 13 bit times (14 if M = 1)

Table 14-7. SCiX2 Field Descriptions (continued)

Field	Description
1 LBKDE	LIN Break Detection Enable — LBKDE is used to select a longer break character detection length. While LBKDE is set, framing error (FE) and receive data register full (RDRF) flags are prevented from setting. 0 Break character is detected at length of 10 bit times (11 if M = 1). 1 Break character is detected at length of 11 bit times (12 if M = 1).
0 RAF	Receiver Active Flag — RAF is set when the SCI receiver detects the beginning of a valid start bit, and RAF is cleared automatically when the receiver detects an idle line. This status flag can be used to check whether an SCI character is being received before instructing the MCU to go to stop mode. 0 SCI receiver idle waiting for a start bit. 1 SCI receiver active (RxD input not idle).

¹ Setting RXINV inverts the RxD input for all cases: data bits, start and stop bits, break, and idle.

When using an internal oscillator in a LIN system, it is necessary to raise the break detection threshold by one bit time. Under the worst case timing conditions allowed in LIN, it is possible that a 0x00 data character can appear to be 10.26 bit times long at a slave which is running 14% faster than the master. This would trigger normal break detection circuitry which is designed to detect a 10 bit break symbol. When the LBKDE bit is set, framing errors are inhibited and the break detection threshold changes from 10 bits to 11 bits, preventing false detection of a 0x00 data character as a LIN break symbol.

14.2.6 SCI Control Register 3 (SCiX3)

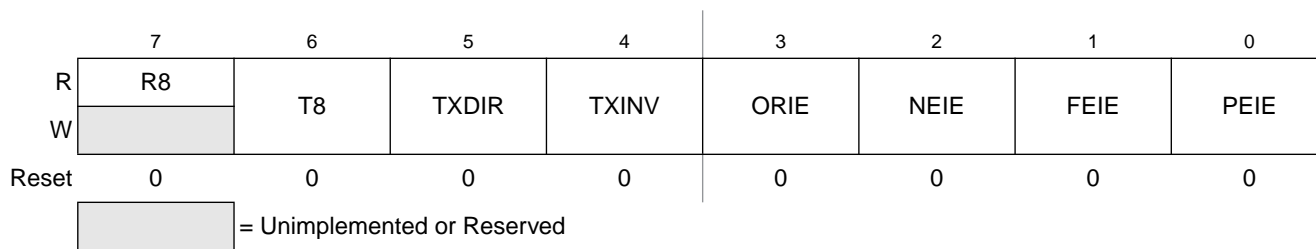

Figure 14-10. SCI Control Register 3 (SCiX3)

Table 14-8. SCiX3 Field Descriptions

Field	Description
7 R8	Ninth Data Bit for Receiver — When the SCI is configured for 9-bit data (M = 1), R8 can be thought of as a ninth receive data bit to the left of the MSB of the buffered data in the SCiXD register. When reading 9-bit data, read R8 before reading SCiXD because reading SCiXD completes automatic flag clearing sequences which could allow R8 and SCiXD to be overwritten with new data.
6 T8	Ninth Data Bit for Transmitter — When the SCI is configured for 9-bit data (M = 1), T8 may be thought of as a ninth transmit data bit to the left of the MSB of the data in the SCiXD register. When writing 9-bit data, the entire 9-bit value is transferred to the SCI shift register after SCiXD is written so T8 should be written (if it needs to change from its previous value) before SCiXD is written. If T8 does not need to change in the new value (such as when it is used to generate mark or space parity), it need not be written each time SCiXD is written.
5 TXDIR	TxD Pin Direction in Single-Wire Mode — When the SCI is configured for single-wire half-duplex operation (LOOPS = RSRC = 1), this bit determines the direction of data at the TxD pin. 0 TxD pin is an input in single-wire mode. 1 TxD pin is an output in single-wire mode.

Table 14-8. SCIxC3 Field Descriptions (continued)

Field	Description
4 TXINV ¹	Transmit Data Inversion — Setting this bit reverses the polarity of the transmitted data output. 0 Transmit data not inverted 1 Transmit data inverted
3 ORIE	Overrun Interrupt Enable — This bit enables the overrun flag (OR) to generate hardware interrupt requests. 0 OR interrupts disabled (use polling). 1 Hardware interrupt requested when OR = 1.
2 NEIE	Noise Error Interrupt Enable — This bit enables the noise flag (NF) to generate hardware interrupt requests. 0 NF interrupts disabled (use polling). 1 Hardware interrupt requested when NF = 1.
1 FEIE	Framing Error Interrupt Enable — This bit enables the framing error flag (FE) to generate hardware interrupt requests. 0 FE interrupts disabled (use polling). 1 Hardware interrupt requested when FE = 1.
0 PEIE	Parity Error Interrupt Enable — This bit enables the parity error flag (PF) to generate hardware interrupt requests. 0 PF interrupts disabled (use polling). 1 Hardware interrupt requested when PF = 1.

¹ Setting TXINV inverts the TxD output for all cases: data bits, start and stop bits, break, and idle.

14.2.7 SCI Data Register (SClxD)

This register is actually two separate registers. Reads return the contents of the read-only receive data buffer and writes go to the write-only transmit data buffer. Reads and writes of this register are also involved in the automatic flag clearing mechanisms for the SCI status flags.

	7	6	5	4	3	2	1	0
R	R7	R6	R5	R4	R3	R2	R1	R0
W	T7	T6	T5	T4	T3	T2	T1	T0
Reset	0	0	0	0	0	0	0	0

Figure 14-11. SCI Data Register (SClxD)

14.3 Functional Description

The SCI allows full-duplex, asynchronous, NRZ serial communication among the MCU and remote devices, including other MCUs. The SCI comprises a baud rate generator, transmitter, and receiver block. The transmitter and receiver operate independently, although they use the same baud rate generator. During normal operation, the MCU monitors the status of the SCI, writes the data to be transmitted, and processes received data. The following describes each of the blocks of the SCI.

14.3.1 Baud Rate Generation

As shown in [Figure 14-12](#), the clock source for the SCI baud rate generator is the bus-rate clock.

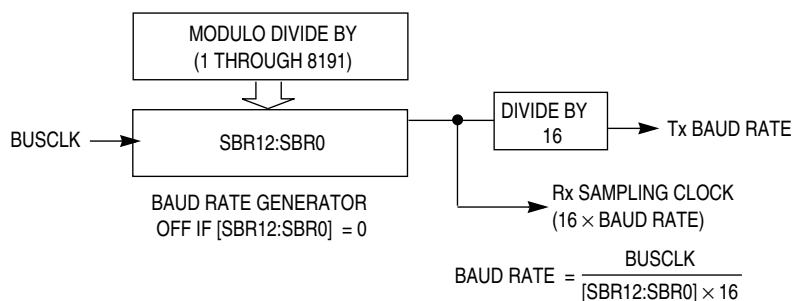

Figure 14-12. SCI Baud Rate Generation

SCI communications require the transmitter and receiver (which typically derive baud rates from independent clock sources) to use the same baud rate. Allowed tolerance on this baud frequency depends on the details of how the receiver synchronizes to the leading edge of the start bit and how bit sampling is performed.

The MCU resynchronizes to bit boundaries on every high-to-low transition, but in the worst case, there are no such transitions in the full 10- or 11-bit time character frame so any mismatch in baud rate is accumulated for the whole character time. For a Freescale Semiconductor SCI system whose bus frequency is driven by a crystal, the allowed baud rate mismatch is about 4.5percent for 8-bit data format and about 4 percent for 9-bit data format. Although baud rate modulo divider settings do not always produce baud rates that exactly match standard rates, it is normally possible to get within a few percent, which is acceptable for reliable communications.

14.3.2 Transmitter Functional Description

This section describes the overall block diagram for the SCI transmitter, as well as specialized functions for sending break and idle characters. The transmitter block diagram is shown in [Figure 14-2](#).

The transmitter output (TxD) idle state defaults to logic high (TXINV = 0 following reset). The transmitter output is inverted by setting TXINV = 1. The transmitter is enabled by setting the TE bit in SCIxC2. This queues a preamble character that is one full character frame of the idle state. The transmitter then remains idle until data is available in the transmit data buffer. Programs store data into the transmit data buffer by writing to the SCI data register (SCIxD).

The central element of the SCI transmitter is the transmit shift register that is either 10 or 11 bits long depending on the setting in the M control bit. For the remainder of this section, we will assume M = 0, selecting the normal 8-bit data mode. In 8-bit data mode, the shift register holds a start bit, eight data bits, and a stop bit. When the transmit shift register is available for a new SCI character, the value waiting in the transmit data register is transferred to the shift register (synchronized with the baud rate clock) and the transmit data register empty (TDRE) status flag is set to indicate another character may be written to the transmit data buffer at SCIxD.

If no new character is waiting in the transmit data buffer after a stop bit is shifted out the TxD pin, the transmitter sets the transmit complete flag and enters an idle mode, with TxD high, waiting for more characters to transmit.

Writing 0 to TE does not immediately release the pin to be a general-purpose I/O pin. Any transmit activity that is in progress must first be completed. This includes data characters in progress, queued idle characters, and queued break characters.

14.3.2.1 Send Break and Queued Idle

The SBK control bit in SCIxC2 is used to send break characters which were originally used to gain the attention of old teletype receivers. Break characters are a full character time of logic 0 (10 bit times including the start and stop bits). A longer break of 13 bit times can be enabled by setting BRK13 = 1. Normally, a program would wait for TDRE to become set to indicate the last character of a message has moved to the transmit shifter, then write 1 and then write 0 to the SBK bit. This action queues a break character to be sent as soon as the shifter is available. If SBK is still 1 when the queued break moves into the shifter (synchronized to the baud rate clock), an additional break character is queued. If the receiving device is another Freescale Semiconductor SCI, the break characters will be received as 0s in all eight data bits and a framing error (FE = 1) occurs.

When idle-line wakeup is used, a full character time of idle (logic 1) is needed between messages to wake up any sleeping receivers. Normally, a program would wait for TDRE to become set to indicate the last character of a message has moved to the transmit shifter, then write 0 and then write 1 to the TE bit. This action queues an idle character to be sent as soon as the shifter is available. As long as the character in the shifter does not finish while TE = 0, the SCI transmitter never actually releases control of the TxD pin. If there is a possibility of the shifter finishing while TE = 0, set the general-purpose I/O controls so the pin that is shared with TxD is an output driving a logic 1. This ensures that the TxD line will look like a normal idle line even if the SCI loses control of the port pin between writing 0 and then 1 to TE.

The length of the break character is affected by the BRK13 and M bits as shown below.

Table 14-9. Break Character Length

BRK13	M	Break Character Length
0	0	10 bit times
0	1	11 bit times
1	0	13 bit times
1	1	14 bit times

14.3.3 Receiver Functional Description

In this section, the receiver block diagram (Figure 14-3) is used as a guide for the overall receiver functional description. Next, the data sampling technique used to reconstruct receiver data is described in more detail. Finally, two variations of the receiver wakeup function are explained.

The receiver input is inverted by setting RXINV = 1. The receiver is enabled by setting the RE bit in SCIxC2. Character frames consist of a start bit of logic 0, eight (or nine) data bits (LSB first), and a stop bit of logic 1. For information about 9-bit data mode, refer to Section 14.3.5.1, “8- and 9-Bit Data Modes.” For the remainder of this discussion, we assume the SCI is configured for normal 8-bit data mode.

After receiving the stop bit into the receive shifter, and provided the receive data register is not already full, the data character is transferred to the receive data register and the receive data register full (RDRF) status

flag is set. If RDRF was already set indicating the receive data register (buffer) was already full, the overrun (OR) status flag is set and the new data is lost. Because the SCI receiver is double-buffered, the program has one full character time after RDRF is set before the data in the receive data buffer must be read to avoid a receiver overrun.

When a program detects that the receive data register is full ($RDRF = 1$), it gets the data from the receive data register by reading SCIxD. The RDRF flag is cleared automatically by a 2-step sequence which is normally satisfied in the course of the user's program that handles receive data. Refer to [Section 14.3.4, "Interrupts and Status Flags"](#) for more details about flag clearing.

14.3.3.1 Data Sampling Technique

The SCI receiver uses a $16\times$ baud rate clock for sampling. The receiver starts by taking logic level samples at 16 times the baud rate to search for a falling edge on the RxD serial data input pin. A falling edge is defined as a logic 0 sample after three consecutive logic 1 samples. The $16\times$ baud rate clock is used to divide the bit time into 16 segments labeled RT1 through RT16. When a falling edge is located, three more samples are taken at RT3, RT5, and RT7 to make sure this was a real start bit and not merely noise. If at least two of these three samples are 0, the receiver assumes it is synchronized to a receive character.

The receiver then samples each bit time, including the start and stop bits, at RT8, RT9, and RT10 to determine the logic level for that bit. The logic level is interpreted to be that of the majority of the samples taken during the bit time. In the case of the start bit, the bit is assumed to be 0 if at least two of the samples at RT3, RT5, and RT7 are 0 even if one or all of the samples taken at RT8, RT9, and RT10 are 1s. If any sample in any bit time (including the start and stop bits) in a character frame fails to agree with the logic level for that bit, the noise flag (NF) will be set when the received character is transferred to the receive data buffer.

The falling edge detection logic continuously looks for falling edges, and if an edge is detected, the sample clock is resynchronized to bit times. This improves the reliability of the receiver in the presence of noise or mismatched baud rates. It does not improve worst case analysis because some characters do not have any extra falling edges anywhere in the character frame.

In the case of a framing error, provided the received character was not a break character, the sampling logic that searches for a falling edge is filled with three logic 1 samples so that a new start bit can be detected almost immediately.

In the case of a framing error, the receiver is inhibited from receiving any new characters until the framing error flag is cleared. The receive shift register continues to function, but a complete character cannot transfer to the receive data buffer if FE is still set.

14.3.3.2 Receiver Wakeup Operation

Receiver wakeup is a hardware mechanism that allows an SCI receiver to ignore the characters in a message that is intended for a different SCI receiver. In such a system, all receivers evaluate the first character(s) of each message, and as soon as they determine the message is intended for a different receiver, they write logic 1 to the receiver wake up (RWU) control bit in SCIxC2. When RWU bit is set, the status flags associated with the receiver (with the exception of the idle bit, IDLE, when RWUID bit is set) are inhibited from setting, thus eliminating the software overhead for handling the unimportant

message characters. At the end of a message, or at the beginning of the next message, all receivers automatically force RWU to 0 so all receivers wake up in time to look at the first character(s) of the next message.

14.3.3.2.1 Idle-Line Wakeup

When WAKE = 0, the receiver is configured for idle-line wakeup. In this mode, RWU is cleared automatically when the receiver detects a full character time of the idle-line level. The M control bit selects 8-bit or 9-bit data mode that determines how many bit times of idle are needed to constitute a full character time (10 or 11 bit times because of the start and stop bits).

When RWU is one and RWUID is zero, the idle condition that wakes up the receiver does not set the IDLE flag. The receiver wakes up and waits for the first data character of the next message which will set the RDRF flag and generate an interrupt if enabled. When RWUID is one, any idle condition sets the IDLE flag and generates an interrupt if enabled, regardless of whether RWU is zero or one.

The idle-line type (ILT) control bit selects one of two ways to detect an idle line. When ILT = 0, the idle bit counter starts after the start bit so the stop bit and any logic 1s at the end of a character count toward the full character time of idle. When ILT = 1, the idle bit counter does not start until after a stop bit time, so the idle detection is not affected by the data in the last character of the previous message.

14.3.3.2.2 Address-Mark Wakeup

When WAKE = 1, the receiver is configured for address-mark wakeup. In this mode, RWU is cleared automatically when the receiver detects a logic 1 in the most significant bit of a received character (eighth bit in M = 0 mode and ninth bit in M = 1 mode).

Address-mark wakeup allows messages to contain idle characters but requires that the MSB be reserved for use in address frames. The logic 1 MSB of an address frame clears the RWU bit before the stop bit is received and sets the RDRF flag. In this case the character with the MSB set is received even though the receiver was sleeping during most of this character time.

14.3.4 Interrupts and Status Flags

The SCI system has three separate interrupt vectors to reduce the amount of software needed to isolate the cause of the interrupt. One interrupt vector is associated with the transmitter for TDRE and TC events. Another interrupt vector is associated with the receiver for RDRF, IDLE, RXEDGIF and LBKDIF events, and a third vector is used for OR, NF, FE, and PF error conditions. Each of these ten interrupt sources can be separately masked by local interrupt enable masks. The flags can still be polled by software when the local masks are cleared to disable generation of hardware interrupt requests.

The SCI transmitter has two status flags that optionally can generate hardware interrupt requests. Transmit data register empty (TDRE) indicates when there is room in the transmit data buffer to write another transmit character to SCIxD. If the transmit interrupt enable (TIE) bit is set, a hardware interrupt will be requested whenever TDRE = 1. Transmit complete (TC) indicates that the transmitter is finished transmitting all data, preamble, and break characters and is idle with TxD at the inactive level. This flag is often used in systems with modems to determine when it is safe to turn off the modem. If the transmit complete interrupt enable (TCIE) bit is set, a hardware interrupt will be requested whenever TC = 1.

Instead of hardware interrupts, software polling may be used to monitor the TDRE and TC status flags if the corresponding TIE or TCIE local interrupt masks are 0s.

When a program detects that the receive data register is full ($RDRF = 1$), it gets the data from the receive data register by reading $SCIxD$. The $RDRF$ flag is cleared by reading $SCIxS1$ while $RDRF = 1$ and then reading $SCIxD$.

When polling is used, this sequence is naturally satisfied in the normal course of the user program. If hardware interrupts are used, $SCIxS1$ must be read in the interrupt service routine (ISR). Normally, this is done in the ISR anyway to check for receive errors, so the sequence is automatically satisfied.

The IDLE status flag includes logic that prevents it from getting set repeatedly when the RxD line remains idle for an extended period of time. IDLE is cleared by reading $SCIxS1$ while $IDLE = 1$ and then reading $SCIxD$. After IDLE has been cleared, it cannot become set again until the receiver has received at least one new character and has set $RDRF$.

If the associated error was detected in the received character that caused $RDRF$ to be set, the error flags — noise flag (NF), framing error (FE), and parity error flag (PF) — get set at the same time as $RDRF$. These flags are not set in overrun cases.

If $RDRF$ was already set when a new character is ready to be transferred from the receive shifter to the receive data buffer, the overrun (OR) flag gets set instead the data along with any associated NF, FE, or PF condition is lost.

At any time, an active edge on the RxD serial data input pin causes the $RXEDGIF$ flag to set. The $RXEDGIF$ flag is cleared by writing a “1” to it. This function does depend on the receiver being enabled ($RE = 1$).

14.3.5 Additional SCI Functions

The following sections describe additional SCI functions.

14.3.5.1 8- and 9-Bit Data Modes

The SCI system (transmitter and receiver) can be configured to operate in 9-bit data mode by setting the M control bit in $SCIxC1$. In 9-bit mode, there is a ninth data bit to the left of the MSB of the SCI data register. For the transmit data buffer, this bit is stored in T8 in $SCIxC3$. For the receiver, the ninth bit is held in R8 in $SCIxC3$.

For coherent writes to the transmit data buffer, write to the T8 bit before writing to $SCIxD$.

If the bit value to be transmitted as the ninth bit of a new character is the same as for the previous character, it is not necessary to write to T8 again. When data is transferred from the transmit data buffer to the transmit shifter, the value in T8 is copied at the same time data is transferred from $SCIxD$ to the shifter.

9-bit data mode typically is used in conjunction with parity to allow eight bits of data plus the parity in the ninth bit. Or it is used with address-mark wakeup so the ninth data bit can serve as the wakeup bit. In custom protocols, the ninth bit can also serve as a software-controlled marker.

14.3.5.2 Stop Mode Operation

During all stop modes, clocks to the SCI module are halted.

In stop1 and stop2 modes, all SCI register data is lost and must be re-initialized upon recovery from these two stop modes. No SCI module registers are affected in stop3 mode.

The receive input active edge detect circuit is still active in stop3 mode, but not in stop2. . An active edge on the receive input brings the CPU out of stop3 mode if the interrupt is not masked (RXEDGIE = 1).

Note, because the clocks are halted, the SCI module will resume operation upon exit from stop (only in stop3 mode). Software should ensure stop mode is not entered while there is a character being transmitted out of or received into the SCI module.

14.3.5.3 Loop Mode

When LOOPS = 1, the RSRC bit in the same register chooses between loop mode (RSRC = 0) or single-wire mode (RSRC = 1). Loop mode is sometimes used to check software, independent of connections in the external system, to help isolate system problems. In this mode, the transmitter output is internally connected to the receiver input and the RxD pin is not used by the SCI, so it reverts to a general-purpose port I/O pin.

14.3.5.4 Single-Wire Operation

When LOOPS = 1, the RSRC bit in the same register chooses between loop mode (RSRC = 0) or single-wire mode (RSRC = 1). Single-wire mode is used to implement a half-duplex serial connection. The receiver is internally connected to the transmitter output and to the TxD pin. The RxD pin is not used and reverts to a general-purpose port I/O pin.

In single-wire mode, the TXDIR bit in SCIxC3 controls the direction of serial data on the TxD pin. When TXDIR = 0, the TxD pin is an input to the SCI receiver and the transmitter is temporarily disconnected from the TxD pin so an external device can send serial data to the receiver. When TXDIR = 1, the TxD pin is an output driven by the transmitter. In single-wire mode, the internal loop back connection from the transmitter to the receiver causes the receiver to receive characters that are sent out by the transmitter.

Chapter 15

Real-Time Counter (S08RTCV1)

15.1 Introduction

The RTC module consists of one 8-bit counter, one 8-bit comparator, several binary-based and decimal-based prescaler dividers, three clock sources, and one programmable periodic interrupt. This module can be used for time-of-day, calendar or any task scheduling functions. It can also serve as a cyclic wake up from low power modes without the need of external components.

All devices in the MC9S08DZ128 Series feature the RTC.

15.1.1 RTC Clock Signal Names

References to ERCLK and IRCLK in this chapter correspond to signals MCGERCLK and MCGIRCLK, respectively.

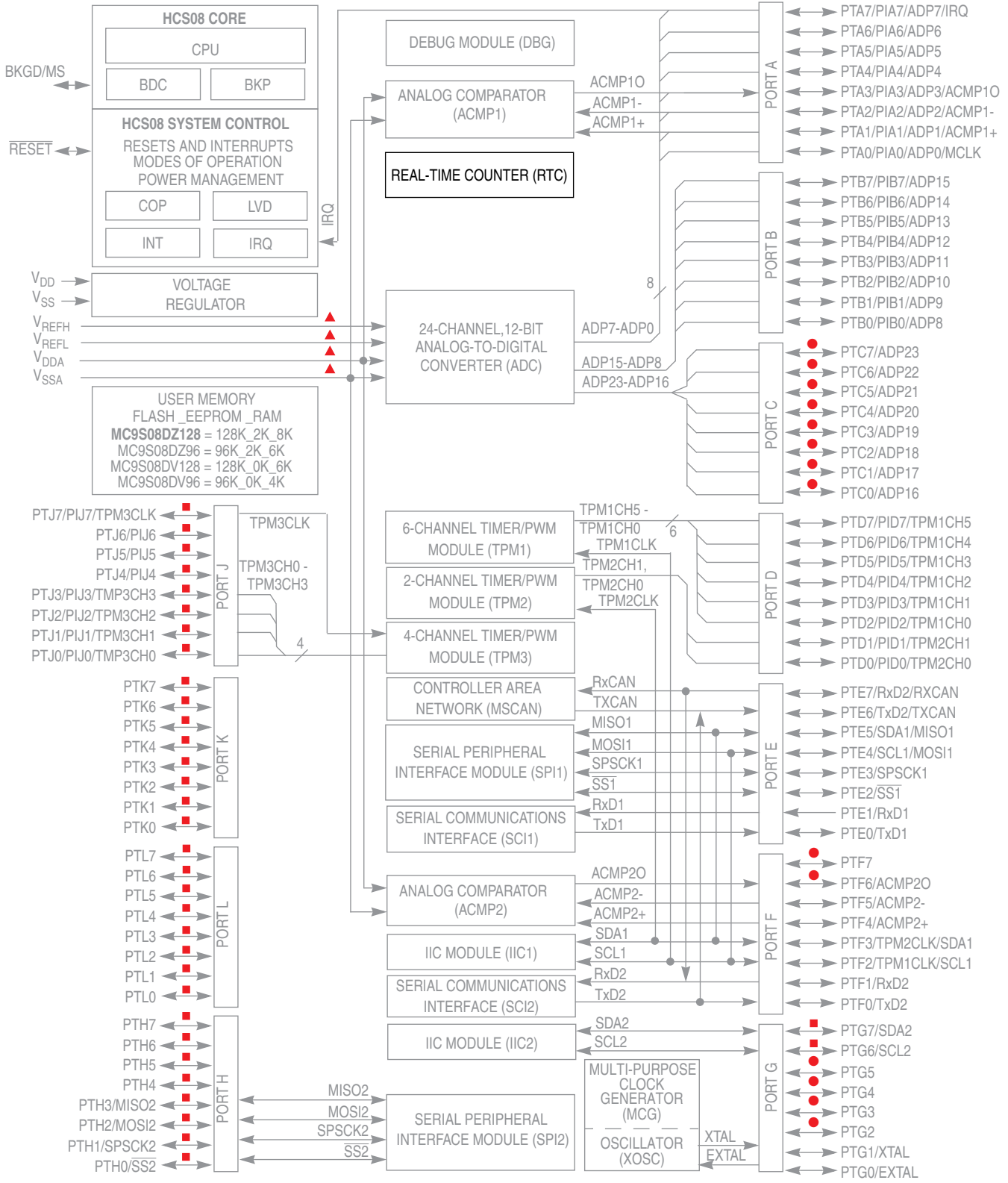

■ - Pin not connected in 64-pin and 48-pin packages ● - Pin not available in the 48-pin package
 ▲ - In 48-pin package, VDDA and VREFH are internally connected to each other and VSSA and VREFL are internally connected to each other.

Figure 15-1. MC9S08DZ128 Block Diagram with RTC Highlighted

15.1.2 Features

Features of the RTC module include:

- 8-bit up-counter
 - 8-bit modulo match limit
 - Software controllable periodic interrupt on match
- Three software selectable clock sources for input to prescaler with selectable binary-based and decimal-based divider values
 - 1-kHz internal low-power oscillator (LPO)
 - External clock (ERCLK)
 - 32-kHz internal clock (IRCLK)

15.1.3 Modes of Operation

This section defines the operation in stop, wait and background debug modes.

15.1.3.1 Wait Mode

The RTC continues to run in wait mode if enabled before executing the appropriate instruction. Therefore, the RTC can bring the MCU out of wait mode if the real-time interrupt is enabled. For lowest possible current consumption, the RTC should be stopped by software if not needed as an interrupt source during wait mode.

15.1.3.2 Stop Modes

The RTC continues to run in stop2 or stop3 mode if the RTC is enabled before executing the STOP instruction. Therefore, the RTC can bring the MCU out of stop modes with no external components, if the real-time interrupt is enabled.

The LPO clock can be used in stop2 and stop3 modes. ERCLK and IRCLK clocks are only available in stop3 mode.

Power consumption is lower when all clock sources are disabled, but in that case, the real-time interrupt cannot wake up the MCU from stop modes.

15.1.3.3 Active Background Mode

The RTC suspends all counting during active background mode until the microcontroller returns to normal user operating mode. Counting resumes from the suspended value as long as the RTCMOD register is not written and the RTCPS and RTCLKS bits are not altered.

15.1.4 Block Diagram

The block diagram for the RTC module is shown in Figure 15-2.

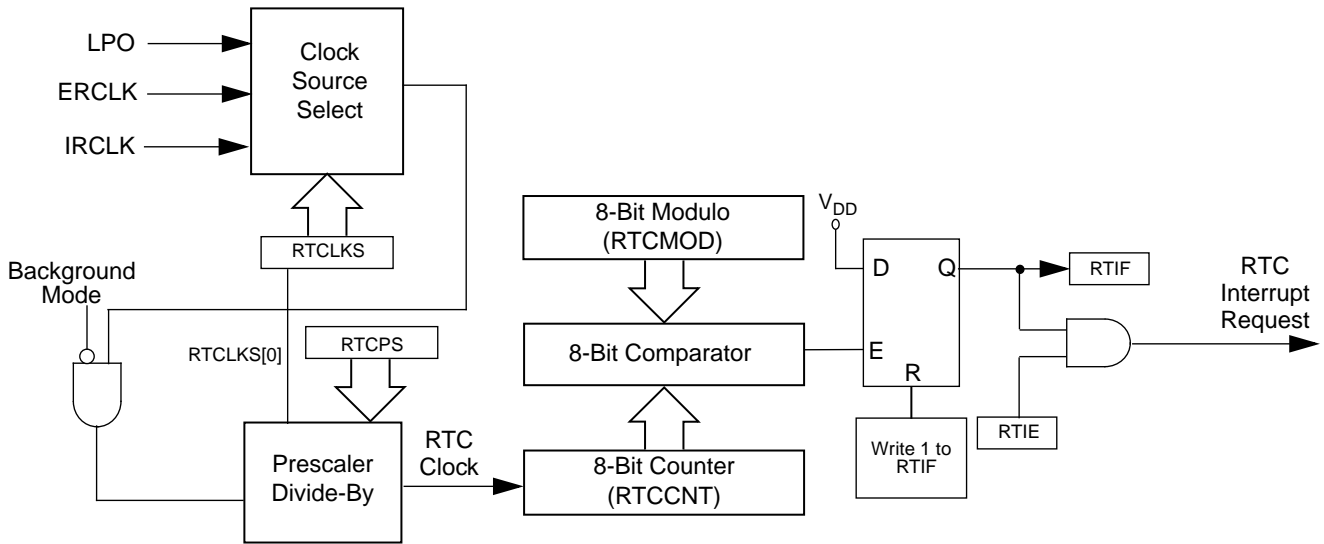

Figure 15-2. Real-Time Counter (RTC) Block Diagram

15.2 External Signal Description

The RTC does not include any off-chip signals.

15.3 Register Definition

The RTC includes a status and control register, an 8-bit counter register, and an 8-bit modulo register.

Refer to the direct-page register summary in the memory section of this document for the absolute address assignments for all RTC registers. This section refers to registers and control bits only by their names and relative address offsets.

Table 15-1 is a summary of RTC registers.

Table 15-1. RTC Register Summary

Name		7	6	5	4	3	2	1	0
RTCSC	R	RTIF	RTCLKS		RTIE	RTCPS			
	W								
RTCCNT	R	RTCCNT							
	W								
RTCMOD	R	RTCMOD							
	W								

15.3.1 RTC Status and Control Register (RTCSC)

RTCSC contains the real-time interrupt status flag (RTIF), the clock select bits (RTCLKS), the real-time interrupt enable bit (RTIE), and the prescaler select bits (RTCPS).

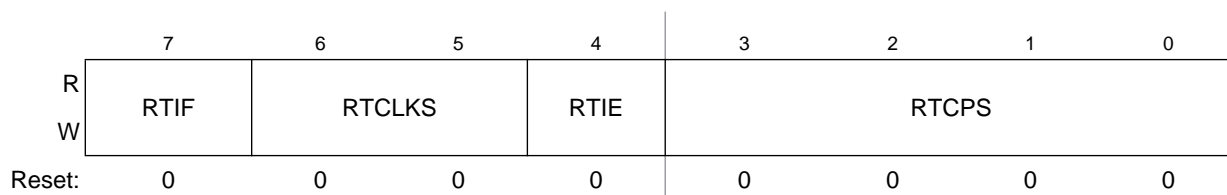

Figure 15-3. RTC Status and Control Register (RTCSC)

Table 15-2. RTCSC Field Descriptions

Field	Description
7 RTIF	Real-Time Interrupt Flag This status bit indicates the RTC counter register reached the value in the RTC modulo register. Writing a logic 0 has no effect. Writing a logic 1 clears the bit and the real-time interrupt request. Reset clears RTIF. 0 RTC counter has not reached the value in the RTC modulo register. 1 RTC counter has reached the value in the RTC modulo register.
6–5 RTCLKS	Real-Time Clock Source Select. These two read/write bits select the clock source input to the RTC prescaler. Changing the clock source clears the prescaler and RTCCNT counters. When selecting a clock source, ensure that the clock source is properly enabled (if applicable) to ensure correct operation of the RTC. Reset clears RTCLKS. 00 Real-time clock source is the 1-kHz low power oscillator (LPO) 01 Real-time clock source is the external clock (ERCLK) 1x Real-time clock source is the internal clock (IRCLK)
4 RTIE	Real-Time Interrupt Enable. This read/write bit enables real-time interrupts. If RTIE is set, then an interrupt is generated when RTIF is set. Reset clears RTIE. 0 Real-time interrupt requests are disabled. Use software polling. 1 Real-time interrupt requests are enabled.
3–0 RTCPS	Real-Time Clock Prescaler Select. These four read/write bits select binary-based or decimal-based divide-by values for the clock source. See Table 15-3 . Changing the prescaler value clears the prescaler and RTCCNT counters. Reset clears RTCPS.

Table 15-3. RTC Prescaler Divide-by values

RTCLKS[0]	RTCPS															
	0	1	2	3	4	5	6	7	8	9	10	11	12	13	14	15
0	Off	2 ³	2 ⁵	2 ⁶	2 ⁷	2 ⁸	2 ⁹	2 ¹⁰	1	2	2 ²	10	2 ⁴	10 ²	5x10 ²	10 ³
1	Off	2 ¹⁰	2 ¹¹	2 ¹²	2 ¹³	2 ¹⁴	2 ¹⁵	2 ¹⁶	10 ³	2x10 ³	5x10 ³	10 ⁴	2x10 ⁴	5x10 ⁴	10 ⁵	2x10 ⁵

15.3.2 RTC Counter Register (RTCCNT)

RTCCNT is the read-only value of the current RTC count of the 8-bit counter.

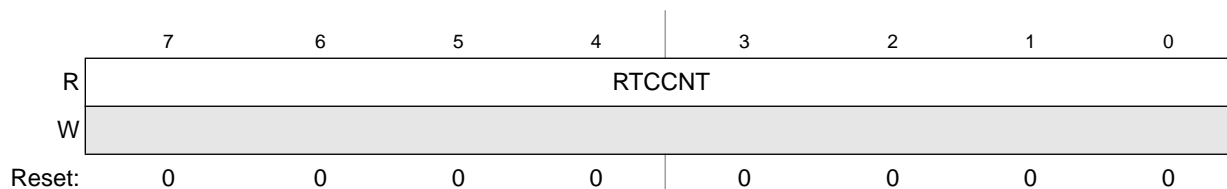

Figure 15-4. RTC Counter Register (RTCCNT)

Table 15-4. RTCCNT Field Descriptions

Field	Description
7:0 RTCCNT	RTC Count. These eight read-only bits contain the current value of the 8-bit counter. Writes have no effect to this register. Reset, writing to RTCMOD, or writing different values to RTCLKS and RTCPS clear the count to 0x00.

15.3.3 RTC Modulo Register (RTCMOD)

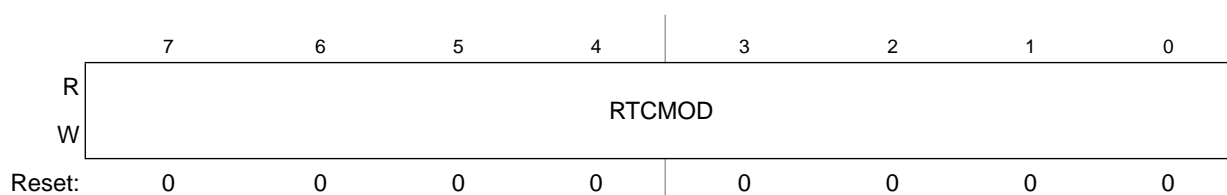

Figure 15-5. RTC Modulo Register (RTCMOD)

Table 15-5. RTCMOD Field Descriptions

Field	Description
7:0 RTCMOD	RTC Modulo. These eight read/write bits contain the modulo value used to reset the count to 0x00 upon a compare match and set the RTIF status bit. A value of 0x00 sets the RTIF bit on each rising edge of the prescaler output. Writing to RTCMOD resets the prescaler and the RTCCNT counters to 0x00. Reset sets the modulo to 0x00.

15.4 Functional Description

The RTC is composed of a main 8-bit up-counter with an 8-bit modulo register, a clock source selector, and a prescaler block with binary-based and decimal-based selectable values. The module also contains software selectable interrupt logic.

After any MCU reset, the counter is stopped and reset to 0x00, the modulus register is set to 0x00, and the prescaler is off. The 1-kHz internal oscillator clock is selected as the default clock source. To start the prescaler, write any value other than zero to the prescaler select bits (RTCPS).

Three clock sources are software selectable: the low power oscillator clock (LPO), the external clock (ERCLK), and the internal clock (IRCLK). The RTC clock select bits (RTCLKS) select the desired clock source. If a different value is written to RTCLKS, the prescaler and RTCCNT counters are reset to 0x00.

RTCPS and the RTCLKS[0] bit select the desired divide-by value. If a different value is written to RTCPS, the prescaler and RTCCNT counters are reset to 0x00. Table 15-6 shows different prescaler period values.

Table 15-6. Prescaler Period

RTCPS	1-kHz Internal Clock (RTCLKS = 00)	1-MHz External Clock (RTCLKS = 01)	32-kHz Internal Clock (RTCLKS = 10)	32-kHz Internal Clock (RTCLKS = 11)
0000	Off	Off	Off	Off
0001	8 ms	1.024 ms	250 μ s	32 ms
0010	32 ms	2.048 ms	1 ms	64 ms
0011	64 ms	4.096 ms	2 ms	128 ms
0100	128 ms	8.192 ms	4 ms	256 ms
0101	256 ms	16.4 ms	8 ms	512 ms
0110	512 ms	32.8 ms	16 ms	1.024 s
0111	1.024 s	65.5 ms	32 ms	2.048 s
1000	1 ms	1 ms	31.25 μ s	31.25 ms
1001	2 ms	2 ms	62.5 μ s	62.5 ms
1010	4 ms	5 ms	125 μ s	156.25 ms
1011	10 ms	10 ms	312.5 μ s	312.5 ms
1100	16 ms	20 ms	0.5 ms	0.625 s
1101	0.1 s	50 ms	3.125 ms	1.5625 s
1110	0.5 s	0.1 s	15.625 ms	3.125 s
1111	1 s	0.2 s	31.25 ms	6.25 s

The RTC modulo register (RTCMOD) allows the compare value to be set to any value from 0x00 to 0xFF. When the counter is active, the counter increments at the selected rate until the count matches the modulo value. When these values match, the counter resets to 0x00 and continues counting. The real-time interrupt flag (RTIF) is set when a match occurs. The flag sets on the transition from the modulo value to 0x00. Writing to RTCMOD resets the prescaler and the RTCCNT counters to 0x00.

The RTC allows for an interrupt to be generated when RTIF is set. To enable the real-time interrupt, set the real-time interrupt enable bit (RTIE) in RTCSC. RTIF is cleared by writing a 1 to RTIF.

15.4.1 RTC Operation Example

This section shows an example of the RTC operation as the counter reaches a matching value from the modulo register.

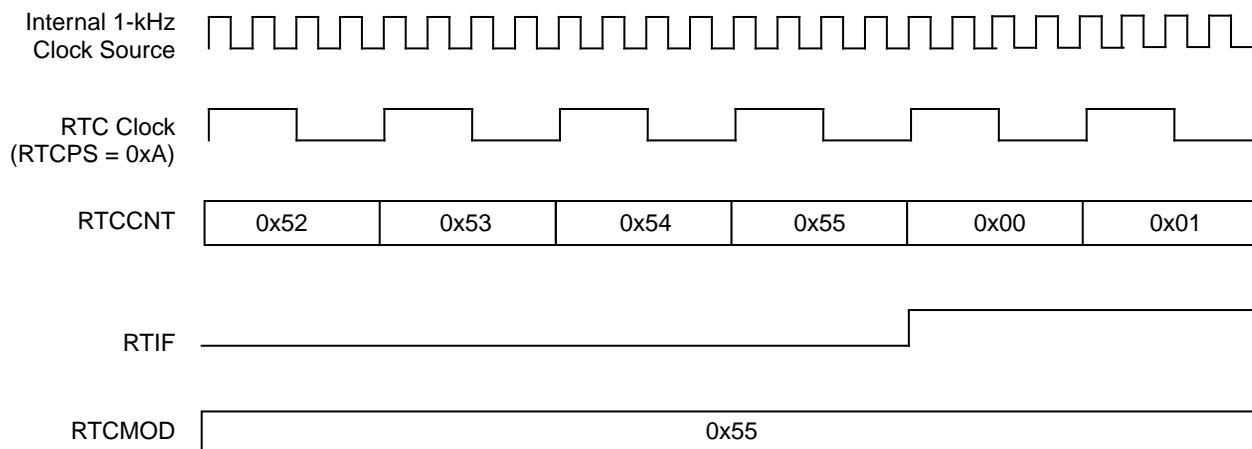

Figure 15-6. RTC Counter Overflow Example

In the example of [Figure 15-6](#), the selected clock source is the 1-kHz internal oscillator clock source. The prescaler (RTCPS) is set to 0xA or divide-by-4. The modulo value in the RTCMOD register is set to 0x55. When the counter, RTCCNT, reaches the modulo value of 0x55, the counter overflows to 0x00 and continues counting. The real-time interrupt flag, RTIF, sets when the counter value changes from 0x55 to 0x00. A real-time interrupt is generated when RTIF is set, if RTIE is set.

15.5 Initialization/Application Information

This section provides example code to give some basic direction to a user on how to initialize and configure the RTC module. The example software is implemented in C language.

The example below shows how to implement time of day with the RTC using the 1-kHz clock source to achieve the lowest possible power consumption. Because the 1-kHz clock source is not as accurate as a crystal, software can be added for any adjustments. For accuracy without adjustments at the expense of additional power consumption, the external clock (ERCLK) or the internal clock (IRCLK) can be selected with appropriate prescaler and modulo values.

```

/* Initialize the elapsed time counters */
Seconds = 0;
Minutes = 0;
Hours = 0;
Days=0;

/* Configure RTC to interrupt every 1 second from 1-kHz clock source */
RTCMOD.byte = 0x00;
RTCSC.byte = 0x1F;

/*****
Function Name : RTC_ISR
Notes : Interrupt service routine for RTC module.
*****/

```

```
#pragma TRAP_PROC
void RTC_ISR(void)
{
    /* Clear the interrupt flag */
    RTCSC.byte = RTCSC.byte | 0x80;
    /* RTC interrupts every 1 Second */
    Seconds++;
    /* 60 seconds in a minute */
    if (Seconds > 59){
        Minutes++;
        Seconds = 0;
    }
    /* 60 minutes in an hour */
    if (Minutes > 59){
        Hours++;
        Minutes = 0;
    }
    /* 24 hours in a day */
    if (Hours > 23){
        Days ++;
        Hours = 0;
    }
}
```

Chapter 16

Timer Pulse-Width Modulator (S08TPMV3)

16.1 Introduction

The TPM uses one input/output (I/O) pin per channel, TPMxCHn, where x is the TPM number (for example, 1 or 2) and n is the channel number (for example, 0–4). The TPM shares its I/O pins with general-purpose I/O port pins (refer to the [Pins and Connections](#) chapter for more information).

NOTE

MC9S08DZ128 Series MCUs have three TPM modules. TPM3 channels are not bonded out in the 64-pin and 48-pin packages.

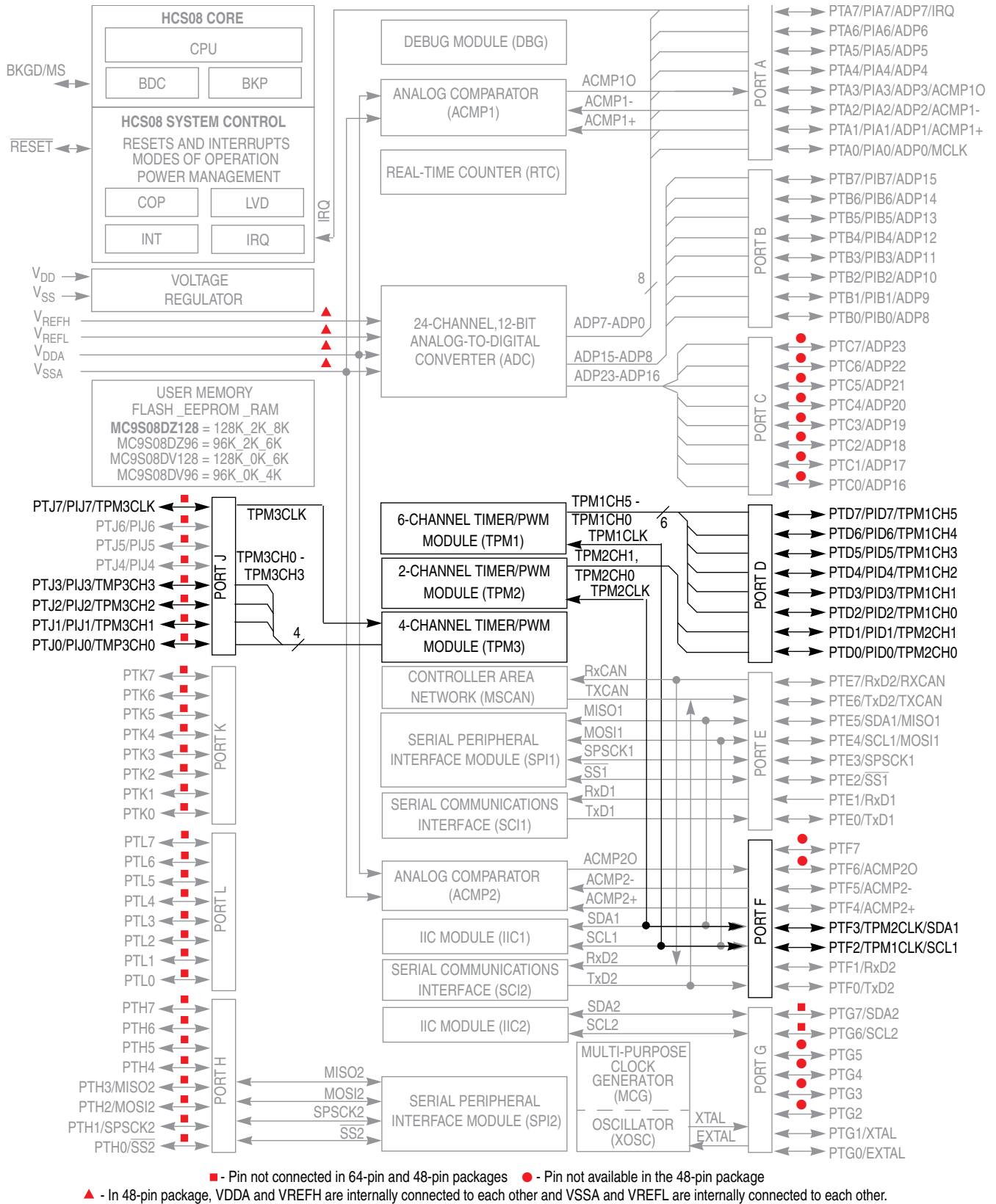

Figure 16-1. MC9S08DZ128 Block Diagram with TPM Highlighted

16.1.1 Features

The TPM includes these distinctive features:

- One to eight channels:
 - Each channel may be input capture, output compare, or edge-aligned PWM
 - Rising-Edge, falling-edge, or any-edge input capture trigger
 - Set, clear, or toggle output compare action
 - Selectable polarity on PWM outputs
- Module may be configured for buffered, center-aligned pulse-width-modulation (CPWM) on all channels
- Timer clock source selectable as prescaled bus clock, fixed system clock, or an external clock pin
 - Prescale taps for divide-by 1, 2, 4, 8, 16, 32, 64, or 128
 - Fixed system clock source are synchronized to the bus clock by an on-chip synchronization circuit
 - External clock pin may be shared with any timer channel pin or a separated input pin
- 16-bit free-running or modulo up/down count operation
- Timer system enable
- One interrupt per channel plus terminal count interrupt

16.1.2 Modes of Operation

In general, TPM channels may be independently configured to operate in input capture, output compare, or edge-aligned PWM modes. A control bit allows the whole TPM (all channels) to switch to center-aligned PWM mode. When center-aligned PWM mode is selected, input capture, output compare, and edge-aligned PWM functions are not available on any channels of this TPM module.

When the microcontroller is in active BDM background or BDM foreground mode, the TPM temporarily suspends all counting until the microcontroller returns to normal user operating mode. During stop mode, all system clocks, including the main oscillator, are stopped; therefore, the TPM is effectively disabled until clocks resume. During wait mode, the TPM continues to operate normally. Provided the TPM does not need to produce a real time reference or provide the interrupt source(s) needed to wake the MCU from wait mode, the user can save power by disabling TPM functions before entering wait mode.

- Input capture mode

When a selected edge event occurs on the associated MCU pin, the current value of the 16-bit timer counter is captured into the channel value register and an interrupt flag bit is set. Rising edges, falling edges, any edge, or no edge (disable channel) may be selected as the active edge which triggers the input capture.
- Output compare mode

When the value in the timer counter register matches the channel value register, an interrupt flag bit is set, and a selected output action is forced on the associated MCU pin. The output compare action may be selected to force the pin to zero, force the pin to one, toggle the pin, or ignore the pin (used for software timing functions).

- Edge-aligned PWM mode

The value of a 16-bit modulo register plus 1 sets the period of the PWM output signal. The channel value register sets the duty cycle of the PWM output signal. The user may also choose the polarity of the PWM output signal. Interrupts are available at the end of the period and at the duty-cycle transition point. This type of PWM signal is called edge-aligned because the leading edges of all PWM signals are aligned with the beginning of the period, which is the same for all channels within a TPM.

- Center-aligned PWM mode

Twice the value of a 16-bit modulo register sets the period of the PWM output, and the channel-value register sets the half-duty-cycle duration. The timer counter counts up until it reaches the modulo value and then counts down until it reaches zero. As the count matches the channel value register while counting down, the PWM output becomes active. When the count matches the channel value register while counting up, the PWM output becomes inactive. This type of PWM signal is called center-aligned because the centers of the active duty cycle periods for all channels are aligned with a count value of zero. This type of PWM is required for types of motors used in small appliances.

This is a high-level description only. Detailed descriptions of operating modes are in later sections.

16.1.3 Block Diagram

The TPM uses one input/output (I/O) pin per channel, TPMxCHn (timer channel n) where n is the channel number (1-8). The TPM shares its I/O pins with general purpose I/O port pins (refer to I/O pin descriptions in full-chip specification for the specific chip implementation).

Figure 16-2 shows the TPM structure. The central component of the TPM is the 16-bit counter that can operate as a free-running counter or a modulo up/down counter. The TPM counter (when operating in normal up-counting mode) provides the timing reference for the input capture, output compare, and edge-aligned PWM functions. The timer counter modulo registers, TPMxMODH:TPMxMODL, control the modulo value of the counter (the values 0x0000 or 0xFFFF effectively make the counter free running). Software can read the counter value at any time without affecting the counting sequence. Any write to either half of the TPMxCNT counter resets the counter, regardless of the data value written.

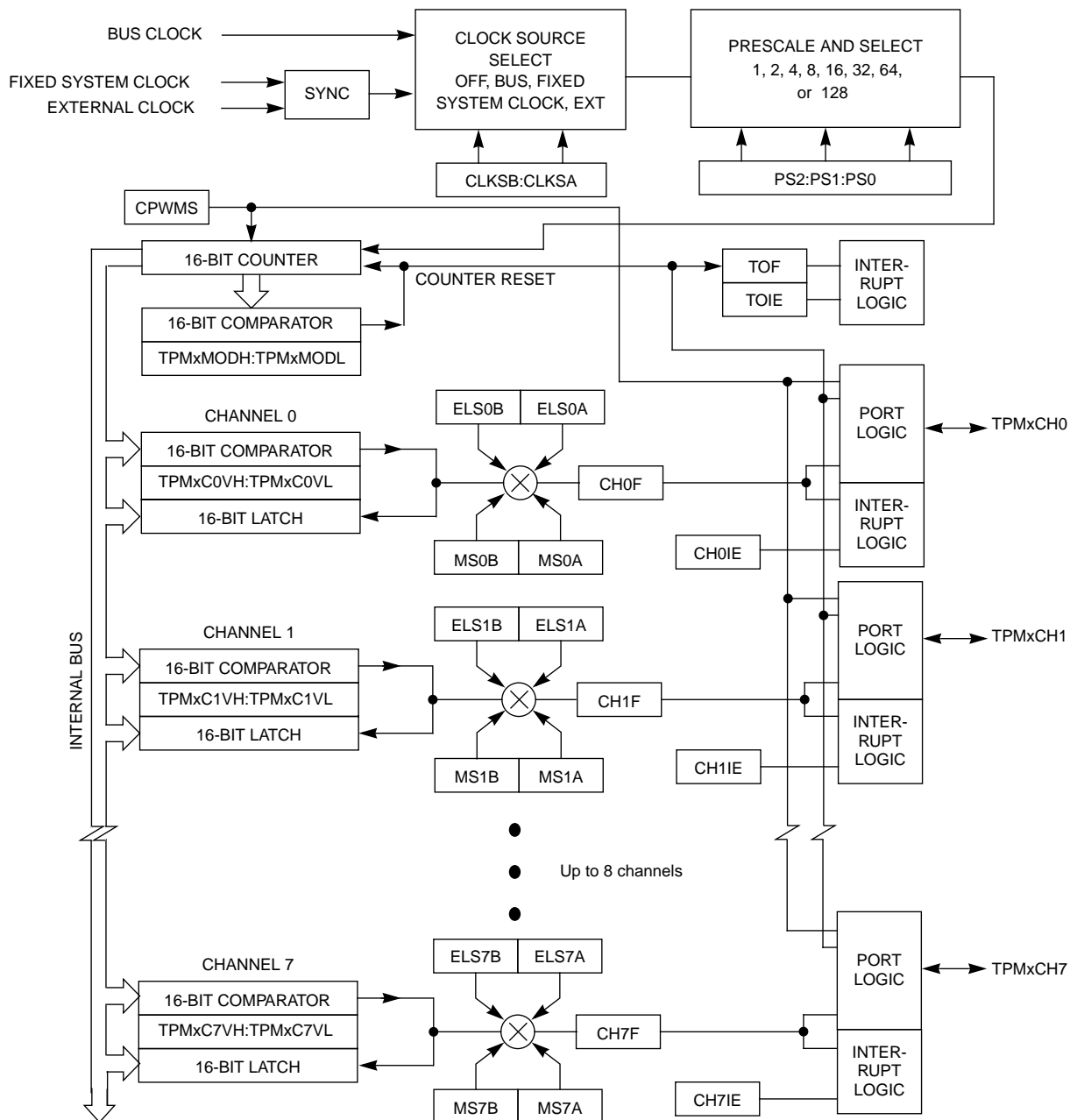

Figure 16-2. TPM Block Diagram

The TPM channels are programmable independently as input capture, output compare, or edge-aligned PWM channels. Alternately, the TPM can be configured to produce CPWM outputs on all channels. When the TPM is configured for CPWMs, the counter operates as an up/down counter; input capture, output compare, and EPWM functions are not practical.

If a channel is configured as input capture, an internal pullup device may be enabled for that channel. The details of how a module interacts with pin controls depends upon the chip implementation because the I/O pins and associated general purpose I/O controls are not part of the module. Refer to the discussion of the I/O port logic in a full-chip specification.

Because center-aligned PWMs are usually used to drive 3-phase AC-induction motors and brushless DC motors, they are typically used in sets of three or six channels.

16.2 Signal Description

Table 16-1 shows the user-accessible signals for the TPM. The number of channels may be varied from one to eight. When an external clock is included, it can be shared with the same pin as any TPM channel; however, it could be connected to a separate input pin. Refer to the I/O pin descriptions in full-chip specification for the specific chip implementation.

Table 16-1. Signal Properties

Name	Function
EXTCLK ¹	External clock source which may be selected to drive the TPM counter.
TPMxCHn ²	I/O pin associated with TPM channel n

¹ When preset, this signal can share any channel pin; however depending upon full-chip implementation, this signal could be connected to a separate external pin.

² n=channel number (1 to 8)

Refer to documentation for the full-chip for details about reset states, port connections, and whether there is any pullup device on these pins.

TPM channel pins can be associated with general purpose I/O pins and have passive pullup devices which can be enabled with a control bit when the TPM or general purpose I/O controls have configured the associated pin as an input. When no TPM function is enabled to use a corresponding pin, the pin reverts to being controlled by general purpose I/O controls, including the port-data and data-direction registers. Immediately after reset, no TPM functions are enabled, so all associated pins revert to general purpose I/O control.

16.2.1 Detailed Signal Descriptions

This section describes each user-accessible pin signal in detail. Although Table 16-1 grouped all channel pins together, any TPM pin can be shared with the external clock source signal. Since I/O pin logic is not part of the TPM, refer to full-chip documentation for a specific derivative for more details about the interaction of TPM pin functions and general purpose I/O controls including port data, data direction, and pullup controls.

16.2.1.1 EXTCLK — External Clock Source

Control bits in the timer status and control register allow the user to select nothing (timer disable), the bus-rate clock (the normal default source), a crystal-related clock, or an external clock as the clock which drives the TPM prescaler and subsequently the 16-bit TPM counter. The external clock source is synchronized in the TPM. The bus clock clocks the synchronizer; the frequency of the external source must be no more than one-fourth the frequency of the bus-rate clock, to meet Nyquist criteria and allowing for jitter.

The external clock signal shares the same pin as a channel I/O pin, so the channel pin will not be usable for channel I/O function when selected as the external clock source. It is the user's responsibility to avoid such settings. If this pin is used as an external clock source (CLKSB:CLKSA = 1:1), the channel can still be used in output compare mode as a software timer (ELSnB:ELSnA = 0:0).

16.2.1.2 TPMxCHn — TPM Channel n I/O Pin(s)

Each TPM channel is associated with an I/O pin on the MCU. The function of this pin depends on the channel configuration. The TPM pins share with general purpose I/O pins, where each pin has a port data register bit, and a data direction control bit, and the port has optional passive pullups which may be enabled whenever a port pin is acting as an input.

The TPM channel does not control the I/O pin when (ELSnB:ELSnA = 0:0) or when (CLKSB:CLKSA = 0:0) so it normally reverts to general purpose I/O control. When CPWMS = 1 (and ELSnB:ELSnA not = 0:0), all channels within the TPM are configured for center-aligned PWM and the TPMxCHn pins are all controlled by the TPM system. When CPWMS=0, the MSnB:MSnA control bits determine whether the channel is configured for input capture, output compare, or edge-aligned PWM.

When a channel is configured for input capture (CPWMS=0, MSnB:MSnA = 0:0 and ELSnB:ELSnA not = 0:0), the TPMxCHn pin is forced to act as an edge-sensitive input to the TPM. ELSnB:ELSnA control bits determine what polarity edge or edges will trigger input-capture events. A synchronizer based on the bus clock is used to synchronize input edges to the bus clock. This implies the minimum pulse width—that can be reliably detected—on an input capture pin is four bus clock periods (with ideal clock pulses as near as two bus clocks can be detected). TPM uses this pin as an input capture input to override the port data and data direction controls for the same pin.

When a channel is configured for output compare (CPWMS=0, MSnB:MSnA = 0:1 and ELSnB:ELSnA not = 0:0), the associated data direction control is overridden, the TPMxCHn pin is considered an output controlled by the TPM, and the ELSnB:ELSnA control bits determine how the pin is controlled. The remaining three combinations of ELSnB:ELSnA determine whether the TPMxCHn pin is toggled, cleared, or set each time the 16-bit channel value register matches the timer counter.

When the output compare toggle mode is initially selected, the previous value on the pin is driven out until the next output compare event—then the pin is toggled.

When a channel is configured for edge-aligned PWM (CPWMS=0, MSnB=1 and ELSnB:ELSnA not = 0:0), the data direction is overridden, the TPMxCHn pin is forced to be an output controlled by the TPM, and ELSnA controls the polarity of the PWM output signal on the pin. When ELSnB:ELSnA=1:0, the TPMxCHn pin is forced high at the start of each new period (TPMxCNT=0x0000), and the pin is forced low when the channel value register matches the timer counter. When ELSnA=1, the TPMxCHn pin is forced low at the start of each new period (TPMxCNT=0x0000), and the pin is forced high when the channel value register matches the timer counter.

TPMxMODH:TPMxMODL = 0x0008
 TPMxMODH:TPMxMODL = 0x0005

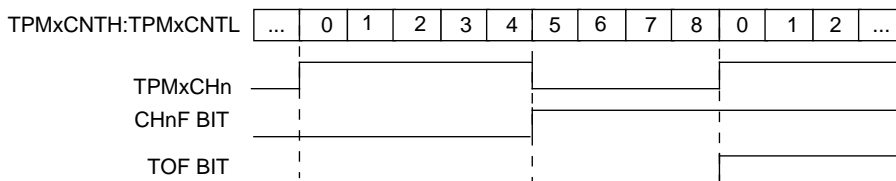

Figure 16-3. High-True Pulse of an Edge-Aligned PWM

TPMxMODH:TPMxMODL = 0x0008
 TPMxMODH:TPMxMODL = 0x0005

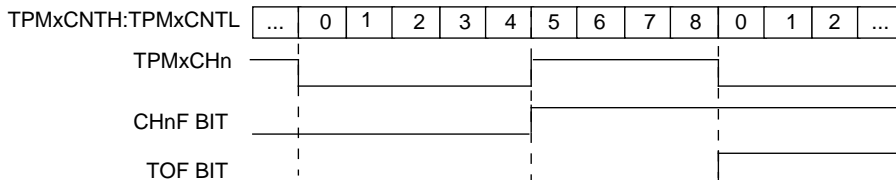

Figure 16-4. Low-True Pulse of an Edge-Aligned PWM

When the TPM is configured for center-aligned PWM (and ELSnB:ELSnA not = 0:0), the data direction for all channels in this TPM are overridden, the TPMxCHn pins are forced to be outputs controlled by the TPM, and the ELSnA bits control the polarity of each TPMxCHn output. If ELSnB:ELSnA=1:0, the corresponding TPMxCHn pin is cleared when the timer counter is counting up, and the channel value register matches the timer counter; the TPMxCHn pin is set when the timer counter is counting down, and the channel value register matches the timer counter. If ELSnA=1, the corresponding TPMxCHn pin is set when the timer counter is counting up and the channel value register matches the timer counter; the TPMxCHn pin is cleared when the timer counter is counting down and the channel value register matches the timer counter.

TPMxMODH:TPMxMODL = 0x0008
 TPMxMODH:TPMxMODL = 0x0005

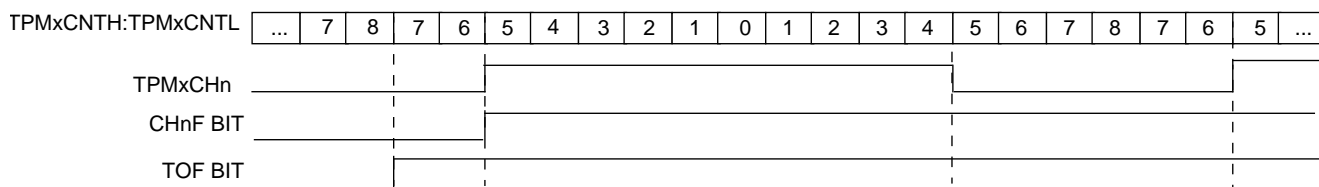

Figure 16-5. High-True Pulse of a Center-Aligned PWM

TPMxMODH:TPMxMODL = 0x0008
 TPMxMODH:TPMxMODL = 0x0005

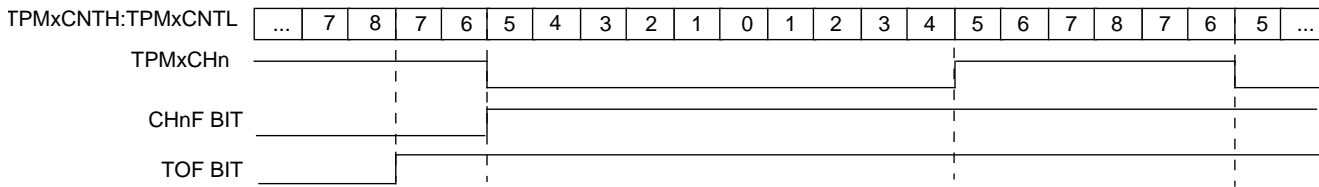

Figure 16-6. Low-True Pulse of a Center-Aligned PWM

16.3 Register Definition

This section consists of register descriptions in address order. A typical MCU system may contain multiple TPMs, and each TPM may have one to eight channels, so register names include placeholder characters to identify which TPM and which channel is being referenced. For example, TPMxCnSC refers to timer (TPM) x, channel n. TPM1C2SC would be the status and control register for channel 2 of timer 1.

16.3.1 TPM Status and Control Register (TPMxSC)

TPMxSC contains the overflow status flag and control bits used to configure the interrupt enable, TPM configuration, clock source, and prescale factor. These controls relate to all channels within this timer module.

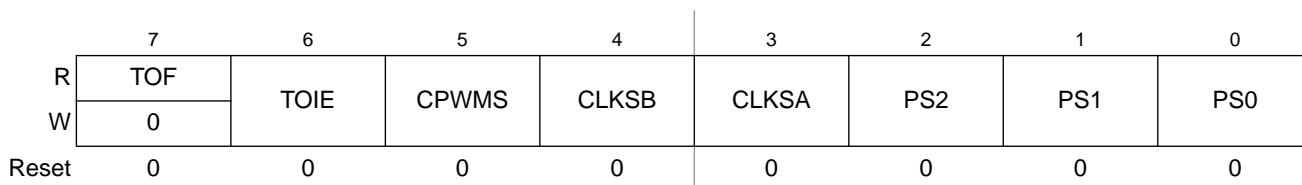

Figure 16-7. TPM Status and Control Register (TPMxSC)

Table 16-2. TPMxSC Field Descriptions

Field	Description
7 TOF	Timer overflow flag. This read/write flag is set when the TPM counter resets to 0x0000 after reaching the modulo value programmed in the TPM counter modulo registers. Clear TOF by reading the TPM status and control register when TOF is set and then writing a logic 0 to TOF. If another TPM overflow occurs before the clearing sequence is complete, the sequence is reset so TOF would remain set after the clear sequence was completed for the earlier TOF. This is done so a TOF interrupt request cannot be lost during the clearing sequence for a previous TOF. Reset clears TOF. Writing a logic 1 to TOF has no effect. 0 TPM counter has not reached modulo value or overflow 1 TPM counter has overflowed
6 TOIE	Timer overflow interrupt enable. This read/write bit enables TPM overflow interrupts. If TOIE is set, an interrupt is generated when TOF equals one. Reset clears TOIE. 0 TOF interrupts inhibited (use for software polling) 1 TOF interrupts enabled
5 CPWMS	Center-aligned PWM select. When present, this read/write bit selects CPWM operating mode. By default, the TPM operates in up-counting mode for input capture, output compare, and edge-aligned PWM functions. Setting CPWMS reconfigures the TPM to operate in up/down counting mode for CPWM functions. Reset clears CPWMS. 0 All channels operate as input capture, output compare, or edge-aligned PWM mode as selected by the MSnB:MSnA control bits in each channel's status and control register. 1 All channels operate in center-aligned PWM mode.

Table 16-2. TPMxSC Field Descriptions (continued)

Field	Description
4–3 CLKS[B:A]	Clock source selects. As shown in Table 16-3 , this 2-bit field is used to disable the TPM system or select one of three clock sources to drive the counter prescaler. The fixed system clock source is only meaningful in systems with a PLL-based or FLL-based system clock. When there is no PLL or FLL, the fixed-system clock source is the same as the bus rate clock. The external source is synchronized to the bus clock by TPM module, and the fixed system clock source (when a PLL or FLL is present) is synchronized to the bus clock by an on-chip synchronization circuit. When a PLL or FLL is present but not enabled, the fixed-system clock source is the same as the bus-rate clock.
2–0 PS[2:0]	Prescale factor select. This 3-bit field selects one of 8 division factors for the TPM clock input as shown in Table 16-4 . This prescaler is located after any clock source synchronization or clock source selection so it affects the clock source selected to drive the TPM system. The new prescale factor will affect the clock source on the next system clock cycle after the new value is updated into the register bits.

Table 16-3. TPM-Clock-Source Selection

CLKSB:CLKSA	TPM Clock Source to Prescaler Input
00	No clock selected (TPM counter disable)
01	Bus rate clock
10	Fixed system clock
11	External source

Table 16-4. Prescale Factor Selection

PS2:PS1:PS0	TPM Clock Source Divided-by
000	1
001	2
010	4
011	8
100	16
101	32
110	64
111	128

16.3.2 TPM-Counter Registers (TPMxCNTH:TPMxCNTL)

The two read-only TPM counter registers contain the high and low bytes of the value in the TPM counter. Reading either byte (TPMxCNTH or TPMxCNTL) latches the contents of both bytes into a buffer where they remain latched until the other half is read. This allows coherent 16-bit reads in either big-endian or little-endian order which makes this more friendly to various compiler implementations. The coherency mechanism is automatically restarted by an MCU reset or any write to the timer status/control register (TPMxSC).

Reset clears the TPM counter registers. Writing any value to TPMxCNTH or TPMxCNTL also clears the TPM counter (TPMxCNTH:TPMxCNTL) and resets the coherency mechanism, regardless of the data involved in the write.

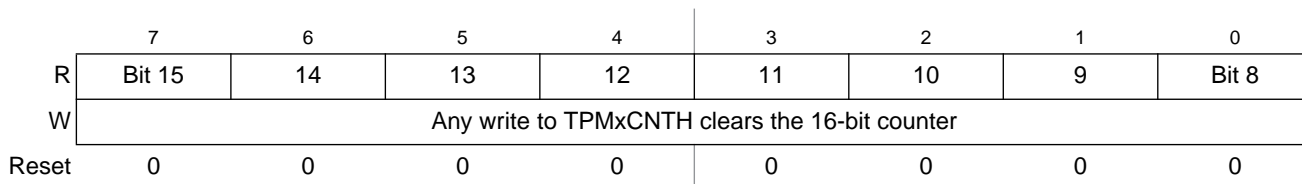

Figure 16-8. TPM Counter Register High (TPMxCNTH)

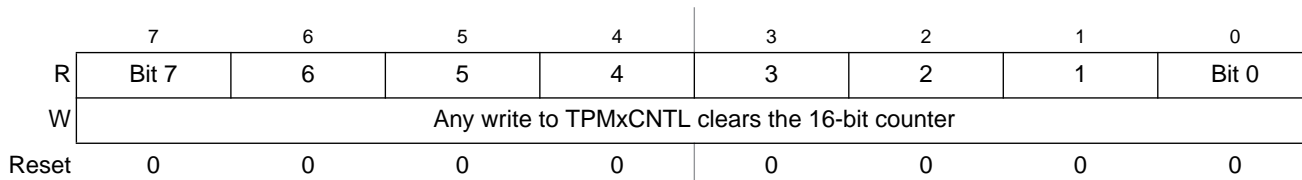

Figure 16-9. TPM Counter Register Low (TPMxCNTL)

When BDM is active, the timer counter is frozen (this is the value that will be read by user); the coherency mechanism is frozen such that the buffer latches remain in the state they were in when the BDM became active, even if one or both counter halves are read while BDM is active. This assures that if the user was in the middle of reading a 16-bit register when BDM became active, it will read the appropriate value from the other half of the 16-bit value after returning to normal execution.

In BDM mode, writing any value to TPMxSC, TPMxCNTH or TPMxCNTL registers resets the read coherency mechanism of the TPMxCNTH:L registers, regardless of the data involved in the write.

16.3.3 TPM Counter Modulo Registers (TPMxMODH:TPMxMODL)

The read/write TPM modulo registers contain the modulo value for the TPM counter. After the TPM counter reaches the modulo value, the TPM counter resumes counting from 0x0000 at the next clock, and the overflow flag (TOF) becomes set. Writing to TPMxMODH or TPMxMODL inhibits the TOF bit and overflow interrupts until the other byte is written. Reset sets the TPM counter modulo registers to 0x0000 which results in a free running timer counter (modulo disabled).

Writing to either byte (TPMxMODH or TPMxMODL) latches the value into a buffer and the registers are updated with the value of their write buffer according to the value of CLKSB:CLKSA bits, so:

- If (CLKSB:CLKSA = 0:0), then the registers are updated when the second byte is written
- If (CLKSB:CLKSA not = 0:0), then the registers are updated after both bytes were written, and the TPM counter changes from (TPMxMODH:TPMxMODL - 1) to (TPMxMODH:TPMxMODL). If the TPM counter is a free-running counter, the update is made when the TPM counter changes from 0xFFFFE to 0xFFFF

The latching mechanism may be manually reset by writing to the TPMxSC address (whether BDM is active or not).

When BDM is active, the coherency mechanism is frozen (unless reset by writing to TPMxSC register) such that the buffer latches remain in the state they were in when the BDM became active, even if one or both halves of the modulo register are written while BDM is active. Any write to the modulo registers bypasses the buffer latches and directly writes to the modulo register while BDM is active.

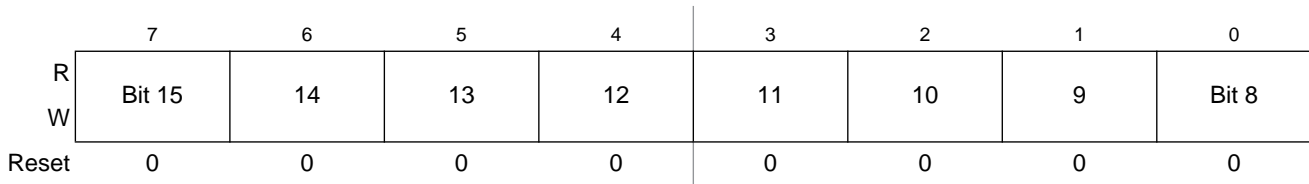

Figure 16-10. TPM Counter Modulo Register High (TPMxMODH)

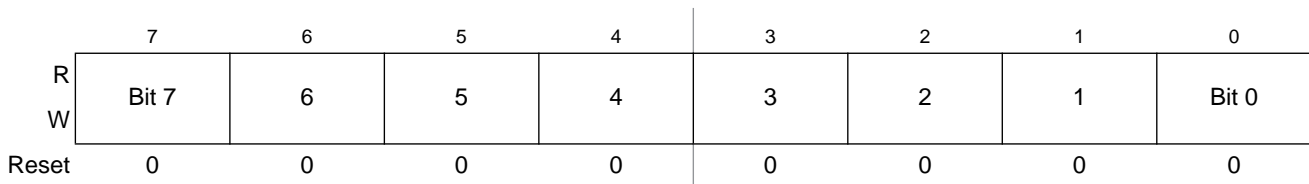

Figure 16-11. TPM Counter Modulo Register Low (TPMxMODL)

Reset the TPM counter before writing to the TPM modulo registers to avoid confusion about when the first counter overflow will occur.

16.3.4 TPM Channel n Status and Control Register (TPMxCnSC)

TPMxCnSC contains the channel-interrupt-status flag and control bits used to configure the interrupt enable, channel configuration, and pin function.

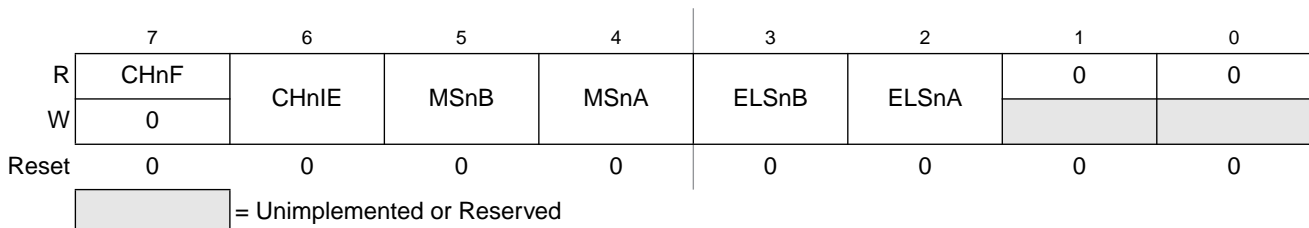

Figure 16-12. TPM Channel n Status and Control Register (TPMxCnSC)

Table 16-5. TPMxCnSC Field Descriptions

Field	Description
7 CHnF	<p>Channel n flag. When channel n is an input-capture channel, this read/write bit is set when an active edge occurs on the channel n pin. When channel n is an output compare or edge-aligned/center-aligned PWM channel, CHnF is set when the value in the TPM counter registers matches the value in the TPM channel n value registers. When channel n is an edge-aligned/center-aligned PWM channel and the duty cycle is set to 0% or 100%, CHnF will not be set even when the value in the TPM counter registers matches the value in the TPM channel n value registers.</p> <p>A corresponding interrupt is requested when CHnF is set and interrupts are enabled (CHnIE = 1). Clear CHnF by reading TPMxCnSC while CHnF is set and then writing a logic 0 to CHnF. If another interrupt request occurs before the clearing sequence is complete, the sequence is reset so CHnF remains set after the clear sequence completed for the earlier CHnF. This is done so a CHnF interrupt request cannot be lost due to clearing a previous CHnF.</p> <p>Reset clears the CHnF bit. Writing a logic 1 to CHnF has no effect.</p> <p>0 No input capture or output compare event occurred on channel n 1 Input capture or output compare event on channel n</p>
6 CHnIE	<p>Channel n interrupt enable. This read/write bit enables interrupts from channel n. Reset clears CHnIE.</p> <p>0 Channel n interrupt requests disabled (use for software polling) 1 Channel n interrupt requests enabled</p>
5 MSnB	<p>Mode select B for TPM channel n. When CPWMS=0, MSnB=1 configures TPM channel n for edge-aligned PWM mode. Refer to the summary of channel mode and setup controls in Table 16-6.</p>
4 MSnA	<p>Mode select A for TPM channel n. When CPWMS=0 and MSnB=0, MSnA configures TPM channel n for input-capture mode or output compare mode. Refer to Table 16-6 for a summary of channel mode and setup controls.</p> <p>Note: If the associated port pin is not stable for at least two bus clock cycles before changing to input capture mode, it is possible to get an unexpected indication of an edge trigger.</p>
3–2 ELSnB ELSnA	<p>Edge/level select bits. Depending upon the operating mode for the timer channel as set by CPWMS:MSnB:MSnA and shown in Table 16-6, these bits select the polarity of the input edge that triggers an input capture event, select the level that will be driven in response to an output compare match, or select the polarity of the PWM output.</p> <p>Setting ELSnB:ELSnA to 0:0 configures the related timer pin as a general purpose I/O pin not related to any timer functions. This function is typically used to temporarily disable an input capture channel or to make the timer pin available as a general purpose I/O pin when the associated timer channel is set up as a software timer that does not require the use of a pin.</p>

Table 16-6. Mode, Edge, and Level Selection

CPWMS	MSnB:MSnA	ELSnB:ELSnA	Mode	Configuration
X	XX	00		Pin not used for TPM - revert to general purpose I/O or other peripheral control

Table 16-6. Mode, Edge, and Level Selection

CPWMS	MSnB:MSnA	ELSnB:ELSnA	Mode	Configuration
0	00	01	Input capture	Capture on rising edge only
		10		Capture on falling edge only
		11		Capture on rising or falling edge
	01	01	Output compare	Toggle output on compare
		10		Clear output on compare
		11		Set output on compare
	1X	10	Edge-aligned PWM	High-true pulses (clear output on compare)
		X1		Low-true pulses (set output on compare)
	1	XX	10	Center-aligned PWM
X1			Low-true pulses (set output on compare-up)	

16.3.5 TPM Channel Value Registers (TPMxCnVH:TPMxCnVL)

These read/write registers contain the captured TPM counter value of the input capture function or the output compare value for the output compare or PWM functions. The channel registers are cleared by reset.

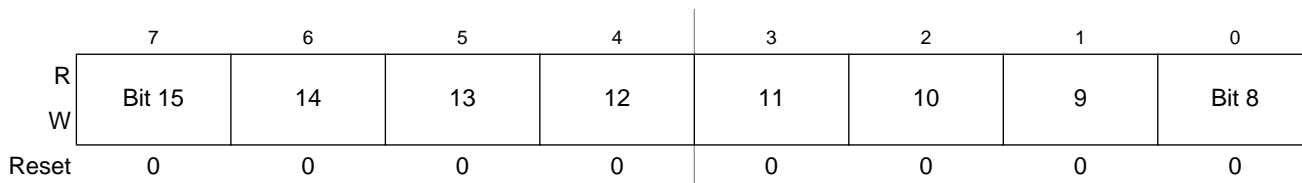
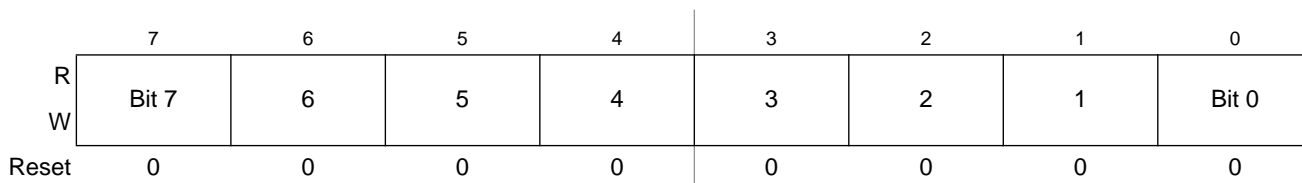
Figure 16-13. TPM Channel Value Register High (TPMxCnVH)

Figure 16-14. TPM Channel Value Register Low (TPMxCnVL)

In input capture mode, reading either byte (TPMxCnVH or TPMxCnVL) latches the contents of both bytes into a buffer where they remain latched until the other half is read. This latching mechanism also resets

(becomes unlatched) when the TPMxCnSC register is written (whether BDM mode is active or not). Any write to the channel registers will be ignored during the input capture mode.

When BDM is active, the coherency mechanism is frozen (unless reset by writing to TPMxCnSC register) such that the buffer latches remain in the state they were in when the BDM became active, even if one or both halves of the channel register are read while BDM is active. This assures that if the user was in the middle of reading a 16-bit register when BDM became active, it will read the appropriate value from the other half of the 16-bit value after returning to normal execution. The value read from the TPMxCnVH and TPMxCnVL registers in BDM mode is the value of these registers and not the value of their read buffer.

In output compare or PWM modes, writing to either byte (TPMxCnVH or TPMxCnVL) latches the value into a buffer. After both bytes are written, they are transferred as a coherent 16-bit value into the timer-channel registers according to the value of CLKS_B:CLKS_A bits and the selected mode, so:

- If (CLKS_B:CLKS_A = 0:0), then the registers are updated when the second byte is written.
- If (CLKS_B:CLKS_A not = 0:0 and in output compare mode) then the registers are updated after the second byte is written and on the next change of the TPM counter (end of the prescaler counting).
- If (CLKS_B:CLKS_A not = 0:0 and in EPWM or CPWM modes), then the registers are updated after the both bytes were written, and the TPM counter changes from (TPMxMODH:TPMxMODL - 1) to (TPMxMODH:TPMxMODL). If the TPM counter is a free-running counter then the update is made when the TPM counter changes from 0xFFFFE to 0xFFFF.

The latching mechanism may be manually reset by writing to the TPMxCnSC register (whether BDM mode is active or not). This latching mechanism allows coherent 16-bit writes in either big-endian or little-endian order which is friendly to various compiler implementations.

When BDM is active, the coherency mechanism is frozen such that the buffer latches remain in the state they were in when the BDM became active even if one or both halves of the channel register are written while BDM is active. Any write to the channel registers bypasses the buffer latches and directly write to the channel register while BDM is active. The values written to the channel register while BDM is active are used for PWM & output compare operation once normal execution resumes. Writes to the channel registers while BDM is active do not interfere with partial completion of a coherency sequence. After the coherency mechanism has been fully exercised, the channel registers are updated using the buffered values written (while BDM was not active) by the user.

16.4 Functional Description

All TPM functions are associated with a central 16-bit counter which allows flexible selection of the clock source and prescale factor. There is also a 16-bit modulo register associated with the main counter.

The CPWMS control bit chooses between center-aligned PWM operation for all channels in the TPM (CPWMS=1) or general purpose timing functions (CPWMS=0) where each channel can independently be configured to operate in input capture, output compare, or edge-aligned PWM mode. The CPWMS control bit is located in the main TPM status and control register because it affects all channels within the TPM and influences the way the main counter operates. (In CPWM mode, the counter changes to an up/down mode rather than the up-counting mode used for general purpose timer functions.)

The following sections describe the main counter and each of the timer operating modes (input capture, output compare, edge-aligned PWM, and center-aligned PWM). Because details of pin operation and interrupt activity depend upon the operating mode, these topics will be covered in the associated mode explanation sections.

16.4.1 Counter

All timer functions are based on the main 16-bit counter (TPMxCNTH:TPMxCNTL). This section discusses selection of the clock source, end-of-count overflow, up-counting vs. up/down counting, and manual counter reset.

16.4.1.1 Counter Clock Source

The 2-bit field, CLKS_B:CLKS_A, in the timer status and control register (TPMxSC) selects one of three possible clock sources or OFF (which effectively disables the TPM). See [Table 16-3](#). After any MCU reset, CLKS_B:CLKS_A=0:0 so no clock source is selected, and the TPM is in a very low power state. These control bits may be read or written at any time and disabling the timer (writing 00 to the CLKS_B:CLKS_A field) does not affect the values in the counter or other timer registers.

Table 16-7. TPM Clock Source Selection

CLKSB:CLKSA	TPM Clock Source to Prescaler Input
00	No clock selected (TPM counter disabled)
01	Bus rate clock
10	Fixed system clock
11	External source

The bus rate clock is the main system bus clock for the MCU. This clock source requires no synchronization because it is the clock that is used for all internal MCU activities including operation of the CPU and buses.

In MCUs that have no PLL and FLL or the PLL and FLL are not engaged, the fixed system clock source is the same as the bus-rate-clock source, and it does not go through a synchronizer. When a PLL or FLL is present and engaged, a synchronizer is required between the crystal divided-by two clock source and the timer counter so counter transitions will be properly aligned to bus-clock transitions. A synchronizer will be used at chip level to synchronize the crystal-related source clock to the bus clock.

The external clock source may be connected to any TPM channel pin. This clock source always has to pass through a synchronizer to assure that counter transitions are properly aligned to bus clock transitions. The bus-rate clock drives the synchronizer; therefore, to meet Nyquist criteria even with jitter, the frequency of the external clock source must not be faster than the bus rate divided-by four. With ideal clocks the external clock can be as fast as bus clock divided by four.

When the external clock source shares the TPM channel pin, this pin should not be used for other channel timing functions. For example, it would be ambiguous to configure channel 0 for input capture when the TPM channel 0 pin was also being used as the timer external clock source. (It is the user's responsibility to avoid such settings.) The TPM channel could still be used in output compare mode for software timing functions (pin controls set not to affect the TPM channel pin).

16.4.1.2 Counter Overflow and Modulo Reset

An interrupt flag and enable are associated with the 16-bit main counter. The flag (TOF) is a software-accessible indication that the timer counter has overflowed. The enable signal selects between software polling (TOIE=0) where no hardware interrupt is generated, or interrupt-driven operation (TOIE=1) where a static hardware interrupt is generated whenever the TOF flag is equal to one.

The conditions causing TOF to become set depend on whether the TPM is configured for center-aligned PWM (CPWMS=1). In the simplest mode, there is no modulus limit and the TPM is not in CPWMS=1 mode. In this case, the 16-bit timer counter counts from 0x0000 through 0xFFFF and overflows to 0x0000 on the next counting clock. TOF becomes set at the transition from 0xFFFF to 0x0000. When a modulus limit is set, TOF becomes set at the transition from the value set in the modulus register to 0x0000. When the TPM is in center-aligned PWM mode (CPWMS=1), the TOF flag gets set as the counter changes direction at the end of the count value set in the modulus register (that is, at the transition from the value set in the modulus register to the next lower count value). This corresponds to the end of a PWM period (the 0x0000 count value corresponds to the center of a period).

16.4.1.3 Counting Modes

The main timer counter has two counting modes. When center-aligned PWM is selected (CPWMS=1), the counter operates in up/down counting mode. Otherwise, the counter operates as a simple up counter. As an up counter, the timer counter counts from 0x0000 through its terminal count and then continues with 0x0000. The terminal count is 0xFFFF or a modulus value in TPMxMODH:TPMxMODL.

When center-aligned PWM operation is specified, the counter counts up from 0x0000 through its terminal count and then down to 0x0000 where it changes back to up counting. Both 0x0000 and the terminal count value are normal length counts (one timer clock period long). In this mode, the timer overflow flag (TOF) becomes set at the end of the terminal-count period (as the count changes to the next lower count value).

16.4.1.4 Manual Counter Reset

The main timer counter can be manually reset at any time by writing any value to either half of TPMxCNTH or TPMxCNTL. Resetting the counter in this manner also resets the coherency mechanism in case only half of the counter was read before resetting the count.

16.4.2 Channel Mode Selection

Provided CPWMS=0, the MSnB and MSnA control bits in the channel n status and control registers determine the basic mode of operation for the corresponding channel. Choices include input capture, output compare, and edge-aligned PWM.

16.4.2.1 Input Capture Mode

With the input-capture function, the TPM can capture the time at which an external event occurs. When an active edge occurs on the pin of an input-capture channel, the TPM latches the contents of the TPM counter into the channel-value registers (TPMxCnVH:TPMxCnVL). Rising edges, falling edges, or any edge may be chosen as the active edge that triggers an input capture.

In input capture mode, the TPMxCnVH and TPMxCnVL registers are read only.

When either half of the 16-bit capture register is read, the other half is latched into a buffer to support coherent 16-bit accesses in big-endian or little-endian order. The coherency sequence can be manually reset by writing to the channel status/control register (TPMxCnSC).

An input capture event sets a flag bit (CHnF) which may optionally generate a CPU interrupt request.

While in BDM, the input capture function works as configured by the user. When an external event occurs, the TPM latches the contents of the TPM counter (which is frozen because of the BDM mode) into the channel value registers and sets the flag bit.

16.4.2.2 Output Compare Mode

With the output-compare function, the TPM can generate timed pulses with programmable position, polarity, duration, and frequency. When the counter reaches the value in the channel-value registers of an output-compare channel, the TPM can set, clear, or toggle the channel pin.

In output compare mode, values are transferred to the corresponding timer channel registers only after both 8-bit halves of a 16-bit register have been written and according to the value of CLKSB:CLKSA bits, so:

- If (CLKSB:CLKSA = 0:0), the registers are updated when the second byte is written
- If (CLKSB:CLKSA not = 0:0), the registers are updated at the next change of the TPM counter (end of the prescaler counting) after the second byte is written.

The coherency sequence can be manually reset by writing to the channel status/control register (TPMxCnSC).

An output compare event sets a flag bit (CHnF) which may optionally generate a CPU-interrupt request.

16.4.2.3 Edge-Aligned PWM Mode

This type of PWM output uses the normal up-counting mode of the timer counter (CPWMS=0) and can be used when other channels in the same TPM are configured for input capture or output compare functions. The period of this PWM signal is determined by the value of the modulus register (TPMxMODH:TPMxMODL) plus 1. The duty cycle is determined by the setting in the timer channel register (TPMxCnVH:TPMxCnVL). The polarity of this PWM signal is determined by the setting in the ELSnA control bit. 0% and 100% duty cycle cases are possible.

The output compare value in the TPM channel registers determines the pulse width (duty cycle) of the PWM signal (Figure 16-15). The time between the modulus overflow and the output compare is the pulse width. If ELSnA=0, the counter overflow forces the PWM signal high, and the output compare forces the PWM signal low. If ELSnA=1, the counter overflow forces the PWM signal low, and the output compare forces the PWM signal high.

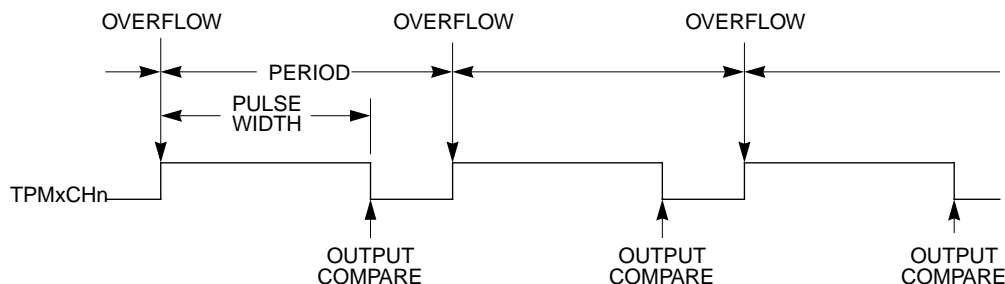

Figure 16-15. PWM Period and Pulse Width (ELSnA=0)

When the channel value register is set to 0x0000, the duty cycle is 0%. 100% duty cycle can be achieved by setting the timer-channel register (TPMxCnVH:TPMxCnVL) to a value greater than the modulus setting. This implies that the modulus setting must be less than 0xFFFF in order to get 100% duty cycle.

Because the TPM may be used in an 8-bit MCU, the settings in the timer channel registers are buffered to ensure coherent 16-bit updates and to avoid unexpected PWM pulse widths. Writes to any of the registers TPMxCnVH and TPMxCnVL, actually write to buffer registers. In edge-aligned PWM mode, values are transferred to the corresponding timer-channel registers according to the value of CLKSB:CLKSA bits, so:

- If (CLKSB:CLKSA = 0:0), the registers are updated when the second byte is written
- If (CLKSB:CLKSA not = 0:0), the registers are updated after the both bytes were written, and the TPM counter changes from (TPMxMODH:TPMxMODL - 1) to (TPMxMODH:TPMxMODL). If

the TPM counter is a free-running counter then the update is made when the TPM counter changes from 0xFFFFE to 0xFFFF.

16.4.2.4 Center-Aligned PWM Mode

This type of PWM output uses the up/down counting mode of the timer counter (CPWMS=1). The output compare value in TPMxCnVH:TPMxCnVL determines the pulse width (duty cycle) of the PWM signal while the period is determined by the value in TPMxMODH:TPMxMODL. TPMxMODH:TPMxMODL should be kept in the range of 0x0001 to 0x7FFF because values outside this range can produce ambiguous results. ELSnA will determine the polarity of the CPWM output.

$$\text{pulse width} = 2 \times (\text{TPMxCnVH:TPMxCnVL})$$

$$\text{period} = 2 \times (\text{TPMxMODH:TPMxMODL}); \text{TPMxMODH:TPMxMODL} = 0x0001 - 0x7FFF$$

If the channel-value register TPMxCnVH:TPMxCnVL is zero or negative (bit 15 set), the duty cycle will be 0%. If TPMxCnVH:TPMxCnVL is a positive value (bit 15 clear) and is greater than the (non-zero) modulus setting, the duty cycle will be 100% because the duty cycle compare will never occur. This implies the usable range of periods set by the modulus register is 0x0001 through 0x7FFE (0x7FFF if you do not need to generate 100% duty cycle). This is not a significant limitation. The resulting period would be much longer than required for normal applications.

TPMxMODH:TPMxMODL=0x0000 is a special case that should not be used with center-aligned PWM mode. When CPWMS=0, this case corresponds to the counter running free from 0x0000 through 0xFFFF, but when CPWMS=1 the counter needs a valid match to the modulus register somewhere other than at 0x0000 in order to change directions from up-counting to down-counting.

The output compare value in the TPM channel registers (times 2) determines the pulse width (duty cycle) of the CPWM signal (Figure 16-16). If ELSnA=0, a compare occurred while counting up forces the CPWM output signal low and a compare occurred while counting down forces the output high. The counter counts up until it reaches the modulo setting in TPMxMODH:TPMxMODL, then counts down until it reaches zero. This sets the period equal to two times TPMxMODH:TPMxMODL.

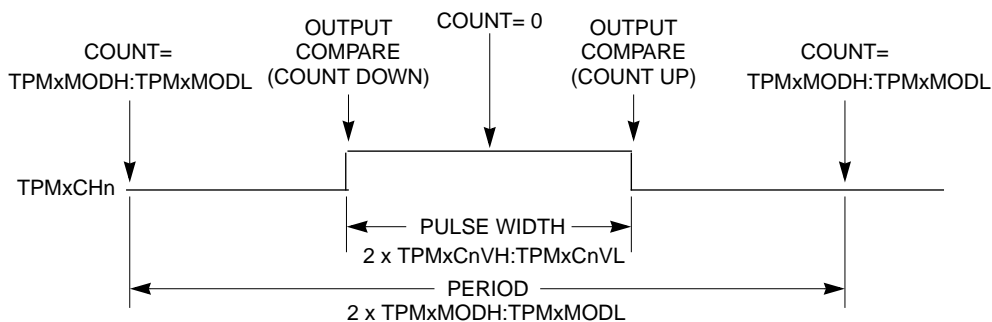

Figure 16-16. CPWM Period and Pulse Width (ELSnA=0)

Center-aligned PWM outputs typically produce less noise than edge-aligned PWMs because fewer I/O pin transitions are lined up at the same system clock edge. This type of PWM is also required for some types of motor drives.

Input capture, output compare, and edge-aligned PWM functions do not make sense when the counter is operating in up/down counting mode so this implies that all active channels within a TPM must be used in CPWM mode when CPWMS=1.

The TPM may be used in an 8-bit MCU. The settings in the timer channel registers are buffered to ensure coherent 16-bit updates and to avoid unexpected PWM pulse widths. Writes to any of the registers TPMxMODH, TPMxMODL, TPMxCnVH, and TPMxCnVL, actually write to buffer registers.

In center-aligned PWM mode, the TPMxCnVH:L registers are updated with the value of their write buffer according to the value of CLKSB:CLKSA bits, so:

- If (CLKSB:CLKSA = 0:0), the registers are updated when the second byte is written
- If (CLKSB:CLKSA not = 0:0), the registers are updated after the both bytes were written, and the TPM counter changes from (TPMxMODH:TPMxMODL - 1) to (TPMxMODH:TPMxMODL). If the TPM counter is a free-running counter, the update is made when the TPM counter changes from 0xFFFFE to 0xFFFF.

When TPMxCNTH:TPMxCNTL=TPMxMODH:TPMxMODL, the TPM can optionally generate a TOF interrupt (at the end of this count).

Writing to TPMxSC cancels any values written to TPMxMODH and/or TPMxMODL and resets the coherency mechanism for the modulo registers. Writing to TPMxCnSC cancels any values written to the channel value registers and resets the coherency mechanism for TPMxCnVH:TPMxCnVL.

16.5 Reset Overview

16.5.1 General

The TPM is reset whenever any MCU reset occurs.

16.5.2 Description of Reset Operation

Reset clears the TPMxSC register which disables clocks to the TPM and disables timer overflow interrupts (TOIE=0). CPWMS, MSnB, MSnA, ELSnB, and ELSnA are all cleared which configures all TPM channels for input-capture operation with the associated pins disconnected from I/O pin logic (so all MCU pins related to the TPM revert to general purpose I/O pins).

16.6 Interrupts

16.6.1 General

The TPM generates an optional interrupt for the main counter overflow and an interrupt for each channel. The meaning of channel interrupts depends on each channel's mode of operation. If the channel is configured for input capture, the interrupt flag is set each time the selected input capture edge is recognized. If the channel is configured for output compare or PWM modes, the interrupt flag is set each time the main timer counter matches the value in the 16-bit channel value register.

All TPM interrupts are listed in Table 16-8 which shows the interrupt name, the name of any local enable that can block the interrupt request from leaving the TPM and getting recognized by the separate interrupt processing logic.

Table 16-8. Interrupt Summary

Interrupt	Local Enable	Source	Description
TOF	TOIE	Counter overflow	Set each time the timer counter reaches its terminal count (at transition to next count value which is usually 0x0000)
CHnF	CHnIE	Channel event	An input capture or output compare event took place on channel n

The TPM module will provide a high-true interrupt signal. Vectors and priorities are determined at chip integration time in the interrupt module so refer to the user's guide for the interrupt module or to the chip's complete documentation for details.

16.6.2 Description of Interrupt Operation

For each interrupt source in the TPM, a flag bit is set upon recognition of the interrupt condition such as timer overflow, channel-input capture, or output-compare events. This flag may be read (polled) by software to determine that the action has occurred, or an associated enable bit (TOIE or CHnIE) can be set to enable hardware interrupt generation. While the interrupt enable bit is set, a static interrupt will generate whenever the associated interrupt flag equals one. The user's software must perform a sequence of steps to clear the interrupt flag before returning from the interrupt-service routine.

TPM interrupt flags are cleared by a two-step process including a read of the flag bit while it is set (1) followed by a write of zero (0) to the bit. If a new event is detected between these two steps, the sequence is reset and the interrupt flag remains set after the second step to avoid the possibility of missing the new event.

16.6.2.1 Timer Overflow Interrupt (TOF) Description

The meaning and details of operation for TOF interrupts varies slightly depending upon the mode of operation of the TPM system (general purpose timing functions versus center-aligned PWM operation). The flag is cleared by the two step sequence described above.

16.6.2.1.1 Normal Case

Normally TOF is set when the timer counter changes from 0xFFFF to 0x0000. When the TPM is not configured for center-aligned PWM (CPWMS=0), TOF gets set when the timer counter changes from the terminal count (the value in the modulo register) to 0x0000. This case corresponds to the normal meaning of counter overflow.

16.6.2.1.2 Center-Aligned PWM Case

When CPWMS=1, TOF gets set when the timer counter changes direction from up-counting to down-counting at the end of the terminal count (the value in the modulo register). In this case the TOF corresponds to the end of a PWM period.

16.6.2.2 Channel Event Interrupt Description

The meaning of channel interrupts depends on the channel's current mode (input-capture, output-compare, edge-aligned PWM, or center-aligned PWM).

16.6.2.2.1 Input Capture Events

When a channel is configured as an input capture channel, the ELSnB:ELSnA control bits select no edge (off), rising edges, falling edges or any edge as the edge which triggers an input capture event. When the selected edge is detected, the interrupt flag is set. The flag is cleared by the two-step sequence described in Section 16.6.2, "Description of Interrupt Operation."

16.6.2.2.2 Output Compare Events

When a channel is configured as an output compare channel, the interrupt flag is set each time the main timer counter matches the 16-bit value in the channel value register. The flag is cleared by the two-step sequence described Section 16.6.2, "Description of Interrupt Operation."

16.6.2.2.3 PWM End-of-Duty-Cycle Events

For channels configured for PWM operation there are two possibilities. When the channel is configured for edge-aligned PWM, the channel flag gets set when the timer counter matches the channel value register which marks the end of the active duty cycle period. When the channel is configured for center-aligned PWM, the timer count matches the channel value register twice during each PWM cycle. In this CPWM case, the channel flag is set at the start and at the end of the active duty cycle period which are the times when the timer counter matches the channel value register. The flag is cleared by the two-step sequence described Section 16.6.2, "Description of Interrupt Operation."

16.7 The Differences from TPM v2 to TPM v3

1. Write to TPMxCnTH:L registers (Section 16.3.2, "TPM-Counter Registers (TPMxCNTH:TPMxCNTL)) [SE110-TPM case 7]

Any write to TPMxCNTH or TPMxCNTL registers in TPM v3 clears the TPM counter (TPMxCNTH:L) and the prescaler counter. Instead, in the TPM v2 only the TPM counter is cleared in this case.

2. Read of TPMxCNTH:L registers (Section 16.3.2, "TPM-Counter Registers (TPMxCNTH:TPMxCNTL))

— In TPM v3, any read of TPMxCNTH:L registers during BDM mode returns the value of the TPM counter that is frozen. In TPM v2, if only one byte of the TPMxCNTH:L registers was read before the BDM mode became active, then any read of TPMxCNTH:L registers during

- BDM mode returns the latched value of TPMxCNTH:L from the read buffer instead of the frozen TPM counter value.
- This read coherency mechanism is cleared in TPM v3 in BDM mode if there is a write to TPMxSC, TPMxCNTH or TPMxCNTL. Instead, in these conditions the TPM v2 does not clear this read coherency mechanism.
3. Read of TPMxCnVH:L registers (Section 16.3.5, “TPM Channel Value Registers (TPMxCnVH:TPMxCnVL)”)
 - In TPM v3, any read of TPMxCnVH:L registers during BDM mode returns the value of the TPMxCnVH:L register. In TPM v2, if only one byte of the TPMxCnVH:L registers was read before the BDM mode became active, then any read of TPMxCnVH:L registers during BDM mode returns the latched value of TPMxCNTH:L from the read buffer instead of the value in the TPMxCnVH:L registers.
 - This read coherency mechanism is cleared in TPM v3 in BDM mode if there is a write to TPMxCnSC. Instead, in this condition the TPM v2 does not clear this read coherency mechanism.
 4. Write to TPMxCnVH:L registers
 - Input Capture Mode (Section 16.4.2.1, “Input Capture Mode”)

In this mode the TPM v3 does not allow the writes to TPMxCnVH:L registers. Instead, the TPM v2 allows these writes.
 - Output Compare Mode (Section 16.4.2.2, “Output Compare Mode”)

In this mode and if (CLKSB:CLKSA not = 0:0), the TPM v3 updates the TPMxCnVH:L registers with the value of their write buffer at the next change of the TPM counter (end of the prescaler counting) after the second byte is written. Instead, the TPM v2 always updates these registers when their second byte is written.
 - Edge-Aligned PWM (Section 16.4.2.3, “Edge-Aligned PWM Mode”)

In this mode and if (CLKSB:CLKSA not = 00), the TPM v3 updates the TPMxCnVH:L registers with the value of their write buffer after that the both bytes were written and when the TPM counter changes from (TPMxMODH:L - 1) to (TPMxMODH:L). If the TPM counter is a free-running counter, then this update is made when the TPM counter changes from \$FFFE to \$FFFF. Instead, the TPM v2 makes this update after that the both bytes were written and when the TPM counter changes from TPMxMODH:L to \$0000.
 - Center-Aligned PWM (Section 16.4.2.4, “Center-Aligned PWM Mode”)

In this mode and if (CLKSB:CLKSA not = 00), the TPM v3 updates the TPMxCnVH:L registers with the value of their write buffer after that the both bytes were written and when the TPM counter changes from (TPMxMODH:L - 1) to (TPMxMODH:L). If the TPM counter is a free-running counter, then this update is made when the TPM counter changes from \$FFFE to \$FFFF. Instead, the TPM v2 makes this update after that the both bytes were written and when the TPM counter changes from TPMxMODH:L to (TPMxMODH:L - 1).
 5. Center-Aligned PWM (Section 16.4.2.4, “Center-Aligned PWM Mode”)
 - TPMxCnVH:L = TPMxMODH:L [SE110-TPM case 1]

In this case, the TPM v3 produces 100% duty cycle. Instead, the TPM v2 produces 0% duty cycle.

- $TPMxCnVH:L = (TPMxMODH:L - 1)$ [SE110-TPM case 2]
 In this case, the TPM v3 produces almost 100% duty cycle. Instead, the TPM v2 produces 0% duty cycle.
 - $TPMxCnVH:L$ is changed from 0x0000 to a non-zero value [SE110-TPM case 3 and 5]
 In this case, the TPM v3 waits for the start of a new PWM period to begin using the new duty cycle setting. Instead, the TPM v2 changes the channel output at the middle of the current PWM period (when the count reaches 0x0000).
 - $TPMxCnVH:L$ is changed from a non-zero value to 0x0000 [SE110-TPM case 4]
 In this case, the TPM v3 finishes the current PWM period using the old duty cycle setting. Instead, the TPM v2 finishes the current PWM period using the new duty cycle setting.
6. Write to $TPMxMODH:L$ registers in BDM mode (Section 16.3.3, “TPM Counter Modulo Registers ($TPMxMODH:TPMxMODL$)”)
 In the TPM v3 a write to $TPMxSC$ register in BDM mode clears the write coherency mechanism of $TPMxMODH:L$ registers. Instead, in the TPM v2 this coherency mechanism is not cleared when there is a write to $TPMxSC$ register.

Chapter 17

Development Support

17.1 Introduction

Development support systems in the HCS08 include the background debug controller (BDC) and the on-chip debug module (DBG). The BDC provides a single-wire debug interface to the target MCU that provides a convenient interface for programming the on-chip FLASH and other nonvolatile memories. The BDC is also the primary debug interface for development and allows non-intrusive access to memory data and traditional debug features such as CPU register modify, breakpoints, and single instruction trace commands.

In the HCS08 Family, address and data bus signals are not available on external pins (not even in test modes). Debug is done through commands fed into the target MCU via the single-wire background debug interface. The debug module provides a means to selectively trigger and capture bus information so an external development system can reconstruct what happened inside the MCU on a cycle-by-cycle basis without having external access to the address and data signals.

17.1.1 Forcing Active Background

The method for forcing active background mode depends on the specific HCS08 derivative. For the MC9S08DZ128 Series, you can force active background after a power-on reset by holding the BKGD pin low as the device exits the reset condition. You can also force active background by driving BKGD low immediately after a serial background command that writes a one to the BDFR bit in the SBDFR register. Other causes of reset including an external pin reset or an internally generated error reset ignore the state of the BKGD pin and reset into normal user mode. If no debug pod is connected to the BKGD pin, the MCU will always reset into normal operating mode.

17.1.2 Features

Features of the BDC module include:

- Single pin for mode selection and background communications
- BDC registers are not located in the memory map
- SYNC command to determine target communications rate
- Non-intrusive commands for memory access
- Active background mode commands for CPU register access
- GO and TRACE1 commands
- BACKGROUND command can wake CPU from stop or wait modes
- One hardware address breakpoint built into BDC
- Oscillator runs in stop mode, if BDC enabled
- COP watchdog disabled while in active background mode

17.2 Background Debug Controller (BDC)

All MCUs in the HCS08 Family contain a single-wire background debug interface that supports in-circuit programming of on-chip nonvolatile memory and sophisticated non-intrusive debug capabilities. Unlike debug interfaces on earlier 8-bit MCUs, this system does not interfere with normal application resources. It does not use any user memory or locations in the memory map and does not share any on-chip peripherals.

BDC commands are divided into two groups:

- Active background mode commands require that the target MCU is in active background mode (the user program is not running). Active background mode commands allow the CPU registers to be read or written, and allow the user to trace one user instruction at a time, or GO to the user program from active background mode.
- Non-intrusive commands can be executed at any time even while the user's program is running. Non-intrusive commands allow a user to read or write MCU memory locations or access status and control registers within the background debug controller.

Typically, a relatively simple interface pod is used to translate commands from a host computer into commands for the custom serial interface to the single-wire background debug system. Depending on the development tool vendor, this interface pod may use a standard RS-232 serial port, a parallel printer port, or some other type of communications such as a universal serial bus (USB) to communicate between the host PC and the pod. The pod typically connects to the target system with ground, the BKGD pin, $\overline{\text{RESET}}$, and sometimes V_{DD} . An open-drain connection to reset allows the host to force a target system reset, which is useful to regain control of a lost target system or to control startup of a target system before the on-chip nonvolatile memory has been programmed. Sometimes V_{DD} can be used to allow the pod to use power from the target system to avoid the need for a separate power supply. However, if the pod is powered separately, it can be connected to a running target system without forcing a target system reset or otherwise disturbing the running application program.

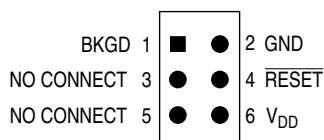

Figure 17-1. BDM Tool Connector

17.2.1 BKGD Pin Description

BKGD is the single-wire background debug interface pin. The primary function of this pin is for bidirectional serial communication of active background mode commands and data. During reset, this pin is used to select between starting in active background mode or starting the user's application program. This pin is also used to request a timed sync response pulse to allow a host development tool to determine the correct clock frequency for background debug serial communications.

BDC serial communications use a custom serial protocol first introduced on the M68HC12 Family of microcontrollers. This protocol assumes the host knows the communication clock rate that is determined by the target BDC clock rate. All communication is initiated and controlled by the host that drives a high-to-low edge to signal the beginning of each bit time. Commands and data are sent most significant bit first (MSB first). For a detailed description of the communications protocol, refer to [Section 17.2.2, "Communication Details."](#)

If a host is attempting to communicate with a target MCU that has an unknown BDC clock rate, a SYNC command may be sent to the target MCU to request a timed sync response signal from which the host can determine the correct communication speed.

BKGD is a pseudo-open-drain pin and there is an on-chip pullup so no external pullup resistor is required. Unlike typical open-drain pins, the external RC time constant on this pin, which is influenced by external capacitance, plays almost no role in signal rise time. The custom protocol provides for brief, actively driven speedup pulses to force rapid rise times on this pin without risking harmful drive level conflicts. Refer to [Section 17.2.2, "Communication Details,"](#) for more detail.

When no debugger pod is connected to the 6-pin BDM interface connector, the internal pullup on BKGD chooses normal operating mode. When a debug pod is connected to BKGD it is possible to force the MCU into active background mode after reset. The specific conditions for forcing active background depend upon the HCS08 derivative (refer to the introduction to this Development Support section). It is not necessary to reset the target MCU to communicate with it through the background debug interface.

17.2.2 Communication Details

The BDC serial interface requires the external controller to generate a falling edge on the BKGD pin to indicate the start of each bit time. The external controller provides this falling edge whether data is transmitted or received.

BKGD is a pseudo-open-drain pin that can be driven either by an external controller or by the MCU. Data is transferred MSB first at 16 BDC clock cycles per bit (nominal speed). The interface times out if 512 BDC clock cycles occur between falling edges from the host. Any BDC command that was in progress

when this timeout occurs is aborted without affecting the memory or operating mode of the target MCU system.

The custom serial protocol requires the debug pod to know the target BDC communication clock speed.

The clock switch (CLKSW) control bit in the BDC status and control register allows the user to select the BDC clock source. The BDC clock source can either be the bus or the alternate BDC clock source.

The BKGD pin can receive a high or low level or transmit a high or low level. The following diagrams show timing for each of these cases. Interface timing is synchronous to clocks in the target BDC, but asynchronous to the external host. The internal BDC clock signal is shown for reference in counting cycles.

Figure 17-2 shows an external host transmitting a logic 1 or 0 to the BKGD pin of a target HCS08 MCU. The host is asynchronous to the target so there is a 0-to-1 cycle delay from the host-generated falling edge to where the target perceives the beginning of the bit time. Ten target BDC clock cycles later, the target senses the bit level on the BKGD pin. Typically, the host actively drives the pseudo-open-drain BKGD pin during host-to-target transmissions to speed up rising edges. Because the target does not drive the BKGD pin during the host-to-target transmission period, there is no need to treat the line as an open-drain signal during this period.

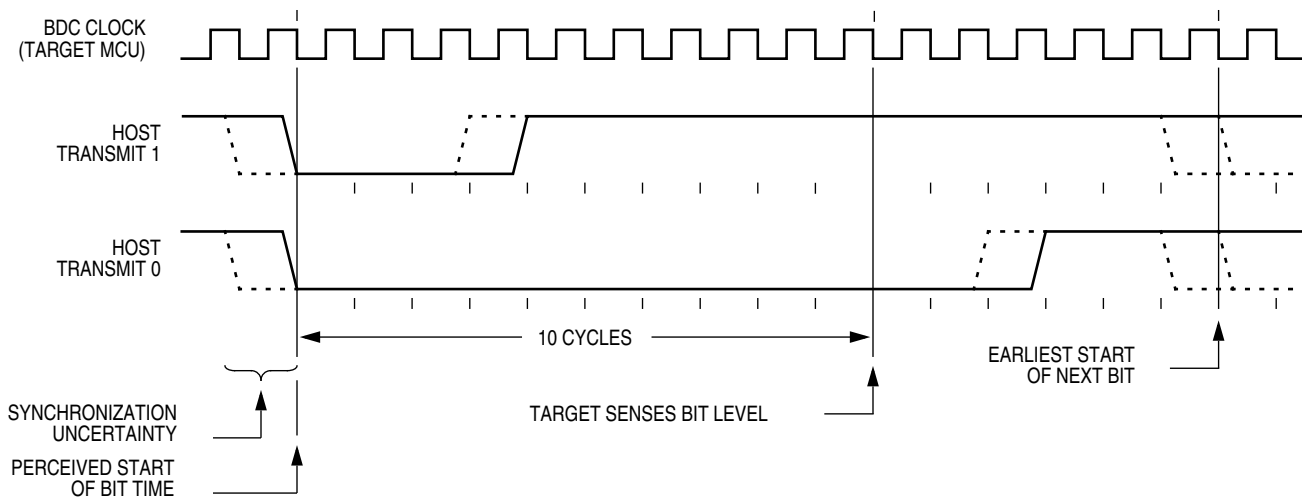

Figure 17-2. BDC Host-to-Target Serial Bit Timing

Figure 17-3 shows the host receiving a logic 1 from the target HCS08 MCU. Because the host is asynchronous to the target MCU, there is a 0-to-1 cycle delay from the host-generated falling edge on BKGD to the perceived start of the bit time in the target MCU. The host holds the BKGD pin low long enough for the target to recognize it (at least two target BDC cycles). The host must release the low drive before the target MCU drives a brief active-high speedup pulse seven cycles after the perceived start of the bit time. The host should sample the bit level about 10 cycles after it started the bit time.

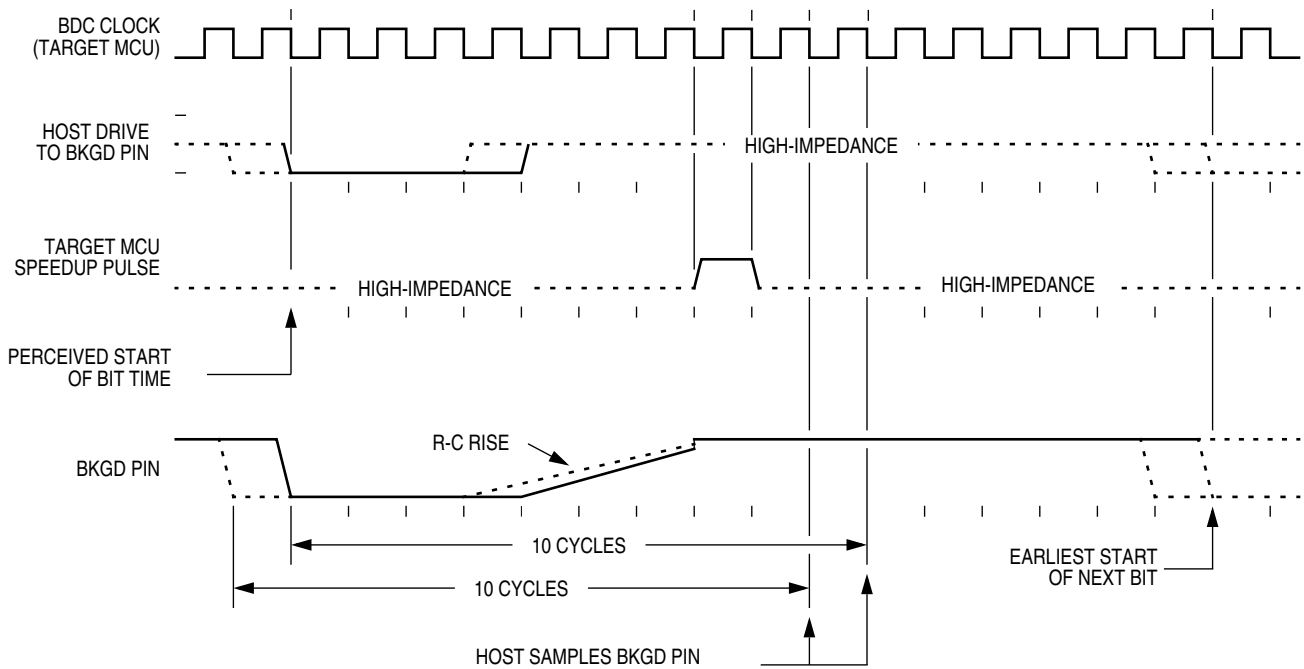

Figure 17-3. BDC Target-to-Host Serial Bit Timing (Logic 1)

Figure 17-4 shows the host receiving a logic 0 from the target HCS08 MCU. Because the host is asynchronous to the target MCU, there is a 0-to-1 cycle delay from the host-generated falling edge on BKGD to the start of the bit time as perceived by the target MCU. The host initiates the bit time but the target HCS08 finishes it. Because the target wants the host to receive a logic 0, it drives the BKGD pin low for 13 BDC clock cycles, then briefly drives it high to speed up the rising edge. The host samples the bit level about 10 cycles after starting the bit time.

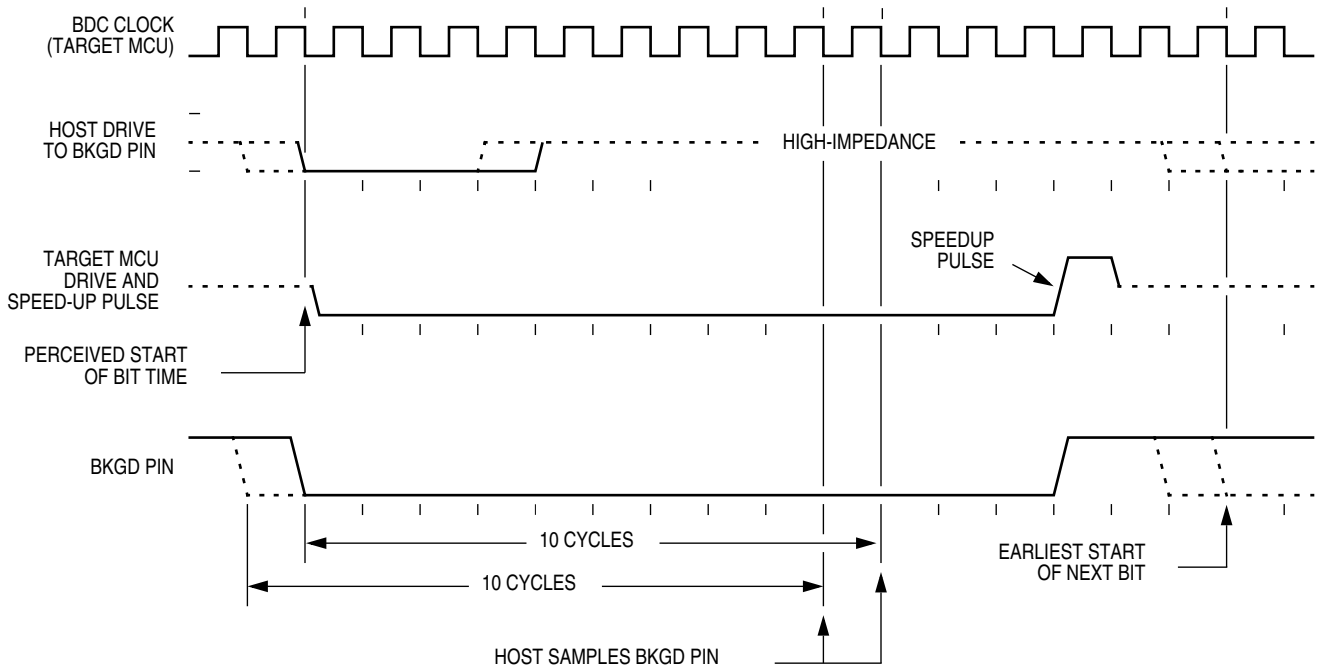

Figure 17-4. BDM Target-to-Host Serial Bit Timing (Logic 0)

17.2.3 BDC Commands

BDC commands are sent serially from a host computer to the BKGD pin of the target HCS08 MCU. All commands and data are sent MSB-first using a custom BDC communications protocol. Active background mode commands require that the target MCU is currently in the active background mode while non-intrusive commands may be issued at any time whether the target MCU is in active background mode or running a user application program.

Table 17-1 shows all HCS08 BDC commands, a shorthand description of their coding structure, and the meaning of each command.

Coding Structure Nomenclature

This nomenclature is used in Table 17-1 to describe the coding structure of the BDC commands.

	Commands begin with an 8-bit hexadecimal command code in the host-to-target direction (most significant bit first)
/	= separates parts of the command
d	= delay 16 target BDC clock cycles
AAAA	= a 16-bit address in the host-to-target direction
RD	= 8 bits of read data in the target-to-host direction
WD	= 8 bits of write data in the host-to-target direction
RD16	= 16 bits of read data in the target-to-host direction
WD16	= 16 bits of write data in the host-to-target direction
SS	= the contents of BDCSCR in the target-to-host direction (STATUS)
CC	= 8 bits of write data for BDCSCR in the host-to-target direction (CONTROL)
RBKP	= 16 bits of read data in the target-to-host direction (from BDCBKPT breakpoint register)
WBKP	= 16 bits of write data in the host-to-target direction (for BDCBKPT breakpoint register)

Table 17-1. BDC Command Summary

Command Mnemonic	Active BDM/ Non-intrusive	Coding Structure	Description
SYNC	Non-intrusive	n/a ¹	Request a timed reference pulse to determine target BDC communication speed
ACK_ENABLE	Non-intrusive	D5/d	Enable acknowledge protocol. Refer to Freescale document order no. HCS08RMv1/D.
ACK_DISABLE	Non-intrusive	D6/d	Disable acknowledge protocol. Refer to Freescale document order no. HCS08RMv1/D.
BACKGROUND	Non-intrusive	90/d	Enter active background mode if enabled (ignore if ENBDM bit equals 0)
READ_STATUS	Non-intrusive	E4/SS	Read BDC status from BDCSCR
WRITE_CONTROL	Non-intrusive	C4/CC	Write BDC controls in BDCSCR
READ_BYTE	Non-intrusive	E0/AAAA/d/RD	Read a byte from target memory
READ_BYTE_WS	Non-intrusive	E1/AAAA/d/SS/RD	Read a byte and report status
READ_LAST	Non-intrusive	E8/SS/RD	Re-read byte from address just read and report status
WRITE_BYTE	Non-intrusive	C0/AAAA/WD/d	Write a byte to target memory
WRITE_BYTE_WS	Non-intrusive	C1/AAAA/WD/d/SS	Write a byte and report status
READ_BKPT	Non-intrusive	E2/RBKP	Read BDCBKPT breakpoint register
WRITE_BKPT	Non-intrusive	C2/WBKP	Write BDCBKPT breakpoint register
GO	Active BDM	08/d	Go to execute the user application program starting at the address currently in the PC
TRACE1	Active BDM	10/d	Trace 1 user instruction at the address in the PC, then return to active background mode
TAGGO	Active BDM	18/d	Same as GO but enable external tagging (HCS08 devices have no external tagging pin)
READ_A	Active BDM	68/d/RD	Read accumulator (A)
READ_CCR	Active BDM	69/d/RD	Read condition code register (CCR)
READ_PC	Active BDM	6B/d/RD16	Read program counter (PC)
READ_HX	Active BDM	6C/d/RD16	Read H and X register pair (H:X)
READ_SP	Active BDM	6F/d/RD16	Read stack pointer (SP)
READ_NEXT	Active BDM	70/d/RD	Increment H:X by one then read memory byte located at H:X
READ_NEXT_WS	Active BDM	71/d/SS/RD	Increment H:X by one then read memory byte located at H:X. Report status and data.
WRITE_A	Active BDM	48/WD/d	Write accumulator (A)
WRITE_CCR	Active BDM	49/WD/d	Write condition code register (CCR)
WRITE_PC	Active BDM	4B/WD16/d	Write program counter (PC)
WRITE_HX	Active BDM	4C/WD16/d	Write H and X register pair (H:X)
WRITE_SP	Active BDM	4F/WD16/d	Write stack pointer (SP)
WRITE_NEXT	Active BDM	50/WD/d	Increment H:X by one, then write memory byte located at H:X
WRITE_NEXT_WS	Active BDM	51/WD/d/SS	Increment H:X by one, then write memory byte located at H:X. Also report status.

¹ The SYNC command is a special operation that does not have a command code.

The SYNC command is unlike other BDC commands because the host does not necessarily know the correct communications speed to use for BDC communications until after it has analyzed the response to the SYNC command.

To issue a SYNC command, the host:

- Drives the BKGD pin low for at least 128 cycles of the slowest possible BDC clock (The slowest clock is normally the reference oscillator/64 or the self-clocked rate/64.)
- Drives BKGD high for a brief speedup pulse to get a fast rise time (This speedup pulse is typically one cycle of the fastest clock in the system.)
- Removes all drive to the BKGD pin so it reverts to high impedance
- Monitors the BKGD pin for the sync response pulse

The target, upon detecting the SYNC request from the host (which is a much longer low time than would ever occur during normal BDC communications):

- Waits for BKGD to return to a logic high
- Delays 16 cycles to allow the host to stop driving the high speedup pulse
- Drives BKGD low for 128 BDC clock cycles
- Drives a 1-cycle high speedup pulse to force a fast rise time on BKGD
- Removes all drive to the BKGD pin so it reverts to high impedance

The host measures the low time of this 128-cycle sync response pulse and determines the correct speed for subsequent BDC communications. Typically, the host can determine the correct communication speed within a few percent of the actual target speed and the communication protocol can easily tolerate speed errors of several percent.

17.2.4 BDC Hardware Breakpoint

The BDC includes one relatively simple hardware breakpoint that compares the CPU address bus to a 16-bit match value in the BDCBKPT register. This breakpoint can generate a forced breakpoint or a tagged breakpoint. A forced breakpoint causes the CPU to enter active background mode at the first instruction boundary following any access to the breakpoint address. The tagged breakpoint causes the instruction opcode at the breakpoint address to be tagged so that the CPU will enter active background mode rather than executing that instruction if and when it reaches the end of the instruction queue. This implies that tagged breakpoints can only be placed at the address of an instruction opcode while forced breakpoints can be set at any address.

The breakpoint enable (BKPTEN) control bit in the BDC status and control register (BDCSCR) is used to enable the breakpoint logic (BKPTEN = 1). When BKPTEN = 0, its default value after reset, the breakpoint logic is disabled and no BDC breakpoints are requested regardless of the values in other BDC breakpoint registers and control bits. The force/tag select (FTS) control bit in BDCSCR is used to select forced (FTS = 1) or tagged (FTS = 0) type breakpoints.

17.3 Register Definition

This section contains the descriptions of the BDC registers and control bits.

This section refers to registers and control bits only by their names. A Freescale-provided equate or header file is used to translate these names into the appropriate absolute addresses.

17.3.1 BDC Registers and Control Bits

The BDC has two registers:

- The BDC status and control register (BDCSCR) is an 8-bit register containing control and status bits for the background debug controller.
- The BDC breakpoint match register (BDCBKPT) holds a 16-bit breakpoint match address.

These registers are accessed with dedicated serial BDC commands and are not located in the memory space of the target MCU (so they do not have addresses and cannot be accessed by user programs).

Some of the bits in the BDCSCR have write limitations; otherwise, these registers may be read or written at any time. For example, the ENBDM control bit may not be written while the MCU is in active background mode. (This prevents the ambiguous condition of the control bit forbidding active background mode while the MCU is already in active background mode.) Also, the four status bits (BDMACT, WS, WSF, and DVF) are read-only status indicators and can never be written by the WRITE_CONTROL serial BDC command. The clock switch (CLKSW) control bit may be read or written at any time.

17.3.1.1 BDC Status and Control Register (BDCSCR)

This register can be read or written by serial BDC commands (READ_STATUS and WRITE_CONTROL) but is not accessible to user programs because it is not located in the normal memory map of the MCU.

	7	6	5	4	3	2	1	0
R	ENBDM	BDMACT	BKPTEN	FTS	CLKSW	WS	WSF	DVF
W								
Normal Reset	0	0	0	0	0	0	0	0
Reset in Active BDM:	1	1	0	0	1	0	0	0

 = Unimplemented or Reserved

Figure 17-5. BDC Status and Control Register (BDCSCR)

Table 17-2. BDCSCR Register Field Descriptions

Field	Description
7 ENBDM	Enable BDM (Permit Active Background Mode) — Typically, this bit is written to 1 by the debug host shortly after the beginning of a debug session or whenever the debug host resets the target and remains 1 until a normal reset clears it. 0 BDM cannot be made active (non-intrusive commands still allowed) 1 BDM can be made active to allow active background mode commands
6 BDMACT	Background Mode Active Status — This is a read-only status bit. 0 BDM not active (user application program running) 1 BDM active and waiting for serial commands
5 BKPTEN	BDC Breakpoint Enable — If this bit is clear, the BDC breakpoint is disabled and the FTS (force tag select) control bit and BDCBKPT match register are ignored. 0 BDC breakpoint disabled 1 BDC breakpoint enabled
4 FTS	Force/Tag Select — When FTS = 1, a breakpoint is requested whenever the CPU address bus matches the BDCBKPT match register. When FTS = 0, a match between the CPU address bus and the BDCBKPT register causes the fetched opcode to be tagged. If this tagged opcode ever reaches the end of the instruction queue, the CPU enters active background mode rather than executing the tagged opcode. 0 Tag opcode at breakpoint address and enter active background mode if CPU attempts to execute that instruction 1 Breakpoint match forces active background mode at next instruction boundary (address need not be an opcode)
3 CLKSW	Select Source for BDC Communications Clock — CLKSW defaults to 0, which selects the alternate BDC clock source. 0 Alternate BDC clock source 1 MCU bus clock

Table 17-2. BDCSCR Register Field Descriptions (continued)

Field	Description
2 WS	<p>Wait or Stop Status — When the target CPU is in wait or stop mode, most BDC commands cannot function. However, the BACKGROUND command can be used to force the target CPU out of wait or stop and into active background mode where all BDC commands work. Whenever the host forces the target MCU into active background mode, the host should issue a READ_STATUS command to check that BDMACT = 1 before attempting other BDC commands.</p> <p>0 Target CPU is running user application code or in active background mode (was not in wait or stop mode when background became active)</p> <p>1 Target CPU is in wait or stop mode, or a BACKGROUND command was used to change from wait or stop to active background mode</p>
1 WSF	<p>Wait or Stop Failure Status — This status bit is set if a memory access command failed due to the target CPU executing a wait or stop instruction at or about the same time. The usual recovery strategy is to issue a BACKGROUND command to get out of wait or stop mode into active background mode, repeat the command that failed, then return to the user program. (Typically, the host would restore CPU registers and stack values and re-execute the wait or stop instruction.)</p> <p>0 Memory access did not conflict with a wait or stop instruction</p> <p>1 Memory access command failed because the CPU entered wait or stop mode</p>
0 DVF	<p>Data Valid Failure Status — This status bit is not used in the MC9S08DZ128 Series because it does not have any slow access memory.</p> <p>0 Memory access did not conflict with a slow memory access</p> <p>1 Memory access command failed because CPU was not finished with a slow memory access</p>

17.3.1.2 BDC Breakpoint Match Register (BDCBKPT)

This 16-bit register holds the address for the hardware breakpoint in the BDC. The BKPTEN and FTS control bits in BDCSCR are used to enable and configure the breakpoint logic. Dedicated serial BDC commands (READ_BKPT and WRITE_BKPT) are used to read and write the BDCBKPT register but is not accessible to user programs because it is not located in the normal memory map of the MCU. Breakpoints are normally set while the target MCU is in active background mode before running the user application program. For additional information about setup and use of the hardware breakpoint logic in the BDC, refer to [Section 17.2.4, “BDC Hardware Breakpoint.”](#)

17.3.2 System Background Debug Force Reset Register (SBDFR)

This register contains a single write-only control bit. A serial background mode command such as WRITE_BYTE must be used to write to SBDFR. Attempts to write this register from a user program are ignored. Reads always return 0x00.

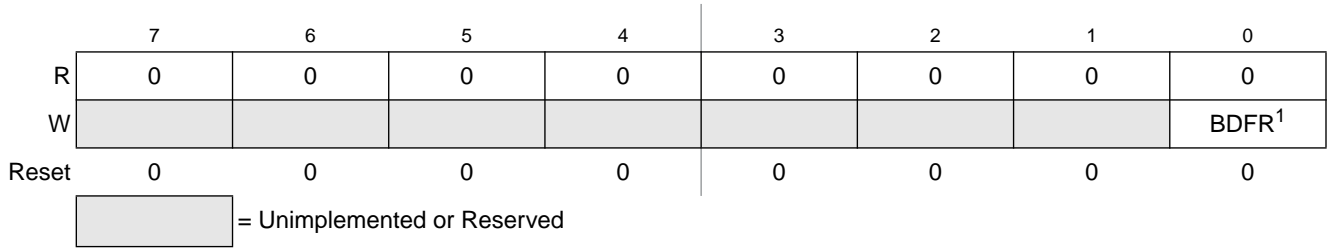

¹ BDFR is writable only through serial background mode debug commands, not from user programs.

Figure 17-6. System Background Debug Force Reset Register (SBDFR)

Table 17-3. SBDFR Register Field Description

Field	Description
0 BDFR	Background Debug Force Reset — A serial active background mode command such as WRITE_BYTE allows an external debug host to force a target system reset. Writing 1 to this bit forces an MCU reset. This bit cannot be written from a user program.

Chapter 18

Debug Module (S08DBGV3) (128K)

18.1 Introduction

The DBG module implements an on-chip ICE (in-circuit emulation) system and allows non-intrusive debug of application software by providing an on-chip trace buffer with flexible triggering capability. The trigger also can provide extended breakpoint capacity. The on-chip ICE system is optimized for the HCS08 8-bit architecture and supports 64K bytes or 128K bytes of memory space.

18.1.1 Features

The on-chip ICE system includes these distinctive features:

- Three comparators (A, B, and C) with ability to match addresses in 128K space
 - Dual mode, Comparators A and B used to compare addresses
 - Full mode, Comparator A compares address and Comparator B compares data
 - Can be used as triggers and/or breakpoints
 - Comparator C can be used as a normal hardware breakpoint
 - Loop1 capture mode, Comparator C is used to track most recent COF event captured into FIFO
- Tag and Force type breakpoints
- Nine trigger modes
 - A
 - A Or B
 - A Then B
 - A And B, where B is data (Full mode)
 - A And Not B, where B is data (Full mode)
 - Event Only B, store data
 - A Then Event Only B, store data
 - Inside Range, $A \leq \text{Address} \leq B$
 - Outside Range, $\text{Address} < A$ or $\text{Address} > B$
- FIFO for storing change of flow information and event only data
 - Source address of conditional branches taken
 - Destination address of indirect JMP and JSR instruction
 - Destination address of interrupts, RTI, RTC, and RTS instruction
 - Data associated with Event B trigger modes

- Ability to End-trace until reset and Begin-trace from reset

18.1.2 Modes of Operation

The on-chip ICE system can be enabled in all MCU functional modes. The DBG module is disabled if the MCU is secure. The DBG module comparators are disabled when executing a Background Debug Mode (BDM) command.

18.1.3 Block Diagram

Figure 18-1 shows the structure of the DBG module.

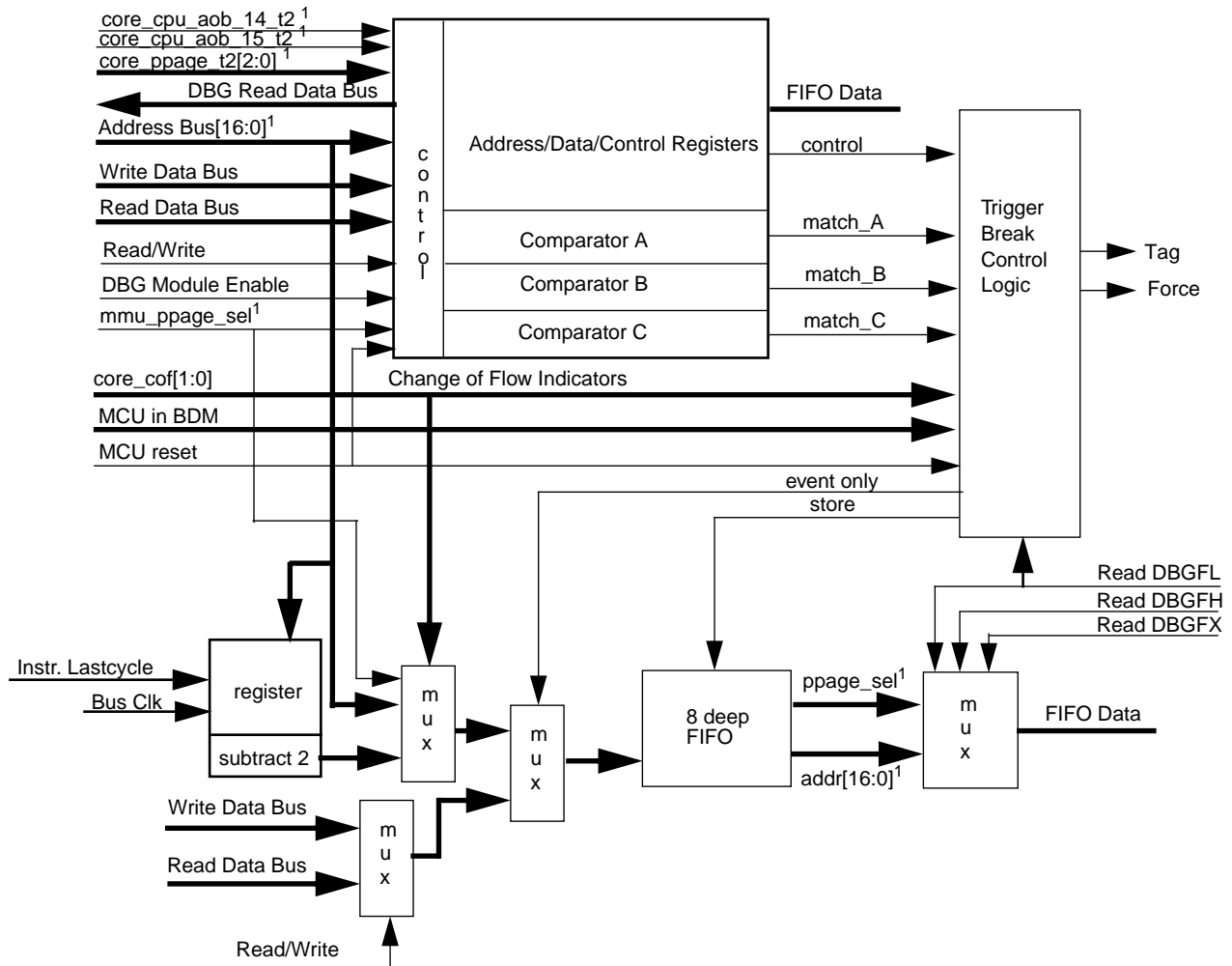

1. In 64K versions of this module there are only 16 address lines [15:0], there are no core_cpu_aob_14_t2, core_cpu_aob_15_t2, core_ppage_t2[2:0], and ppage_sel signals.

Figure 18-1. DBG Block Diagram

18.2 Signal Description

The DBG module contains no external signals.

18.3 Memory Map and Registers

This section provides a detailed description of all DBG registers accessible to the end user.

18.3.1 Module Memory Map

Table 18-1 shows the registers contained in the DBG module.

Table 18-1. Module Memory Map

Address	Use	Access
Base + \$0000	Debug Comparator A High Register (DBGCAH)	Read/write
Base + \$0001	Debug Comparator A Low Register (DBGCAL)	Read/write
Base + \$0002	Debug Comparator B High Register (DBGCBH)	Read/write
Base + \$0003	Debug Comparator B Low Register (DBGCBL)	Read/write
Base + \$0004	Debug Comparator C High Register (DBGCCH)	Read/write
Base + \$0005	Debug Comparator C Low Register (DBGCCL)	Read/write
Base + \$0006	Debug FIFO High Register (DBGFH)	Read only
Base + \$0007	Debug FIFO Low Register (DBGFL)	Read only
Base + \$0008	Debug Comparator A Extension Register (DBGCAE)	Read/write
Base + \$0009	Debug Comparator B Extension Register (DBGCBX)	Read/write
Base + \$000A	Debug Comparator C Extension Register (DBGCCX)	Read/write
Base + \$000B	Debug FIFO Extended Information Register (DBGFX)	Read only
Base + \$000C	Debug Control Register (DBGCC)	Read/write
Base + \$000D	Debug Trigger Register (DBGTR)	Read/write
Base + \$000E	Debug Status Register (DBGST)	Read only
Base + \$000F	Debug FIFO Count Register (DBGFCNT)	Read only

18.3.2

Table 18-2. Register Bit Summary

	7	6	5	4	3	2	1	0
DBGCAH	Bit 15	Bit 14	Bit 13	Bit 12	Bit 11	Bit 10	Bit 9	Bit 8
DBGCAL	Bit 7	Bit 6	Bit 5	Bit 4	Bit 3	Bit 2	Bit 1	Bit 0
DBGCBH	Bit 15	Bit 14	Bit 13	Bit 12	Bit 11	Bit 10	Bit 9	Bit 8
DBGCBL	Bit 7	Bit 6	Bit 5	Bit 4	Bit 3	Bit 2	Bit 1	Bit 0
DBGCCH	Bit 15	Bit 14	Bit 13	Bit 12	Bit 11	Bit 10	Bit 9	Bit 8
DBGCCL	Bit 7	Bit 6	Bit 5	Bit 4	Bit 3	Bit 2	Bit 1	Bit 0
DBGFH	Bit 15	Bit 14	Bit 13	Bit 12	Bit 11	Bit 10	Bit 9	Bit 8
DBGFL	Bit 7	Bit 6	Bit 5	Bit 4	Bit 3	Bit 2	Bit 1	Bit 0
DBGCAx	RWAEN	RWA	PAGSEL	0	0	0	0	bit-16
DBGCBx	RWBEN	RWB	PAGSEL	0	0	0	0	bit-16
DBGCCx	RWCEN	RWC	PAGSEL	0	0	0	0	bit-16
DBGFX	PPACC	0	0	0	0	0	0	bit-16
DBGC	DBGEN	ARM	TAG	BRKEN	-	-	-	LOOP1
DBGT	TRGSEL	BEGIN	0	0	TRG[3:0]			
DBGS	AF	BF	CF	0	0	0	0	ARMF
DBGCNT	0	0	0	0	CNT[3:0]			

18.3.3 Register Descriptions

This section consists of the DBG register descriptions in address order.

Note: For all registers below, consider: U = Unchanged, bit maintain its value after reset.

18.3.3.1 Debug Comparator A High Register (DBGCAH)

Module Base + 0x0000

	7	6	5	4	3	2	1	0
R								
W	Bit 15	Bit 14	Bit 13	Bit 12	Bit 11	Bit 10	Bit 9	Bit 8
POR or non- end-run	1	1	1	1	1	1	1	1
Reset end-run ¹	U	U	U	U	U	U	U	U

Figure 18-2. Debug Comparator A High Register (DBGCAH)

¹ In the case of an end-trace to reset where DBGEN=1 and BEGIN=0, the bits in this register do not change after reset.

Table 18-3. DBGCAH Field Descriptions

Field	Description
Bits 15–8	Comparator A High Compare Bits — The Comparator A High compare bits control whether Comparator A will compare the address bus bits [15:8] to a logic 1 or logic 0. 0 Compare corresponding address bit to a logic 0 1 Compare corresponding address bit to a logic 1

18.3.3.2 Debug Comparator A Low Register (DBGCAL)

Module Base + 0x0001

	7	6	5	4	3	2	1	0
R								
W	Bit 7	Bit 6	Bit 5	Bit 4	Bit 3	Bit 2	Bit 1	Bit 0
POR or non- end-run	1	1	1	1	1	1	1	0
Reset end-run ¹	U	U	U	U	U	U	U	U

Figure 18-3. Debug Comparator A Low Register (DBGCAL)

¹ In the case of an end-trace to reset where DBGEN=1 and BEGIN=0, the bits in this register do not change after reset.

Table 18-4. DBGCAL Field Descriptions

Field	Description
Bits 7–0	Comparator A Low Compare Bits — The Comparator A Low compare bits control whether Comparator A will compare the address bus bits [7:0] to a logic 1 or logic 0. 0 Compare corresponding address bit to a logic 0 1 Compare corresponding address bit to a logic 1

18.3.3.3 Debug Comparator B High Register (DBGCBH)

Module Base + 0x0002

	7	6	5	4	3	2	1	0
R								
W	Bit 15	Bit 14	Bit 13	Bit 12	Bit 11	Bit 10	Bit 9	Bit 8
POR or non- end-run	0	0	0	0	0	0	0	0
Reset end-run ¹	U	U	U	U	U	U	U	U

Figure 18-4. Debug Comparator B High Register (DBGCBH)

¹ In the case of an end-trace to reset where DBGEN=1 and BEGIN=0, the bits in this register do not change after reset.

Table 18-5. DBGCBH Field Descriptions

Field	Description
Bits 15–8	Comparator B High Compare Bits — The Comparator B High compare bits control whether Comparator B will compare the address bus bits [15:8] to a logic 1 or logic 0. Not used in Full mode. 0 Compare corresponding address bit to a logic 0 1 Compare corresponding address bit to a logic 1

18.3.3.4 Debug Comparator B Low Register (DBGCBL)

Module Base + 0x0003

	7	6	5	4	3	2	1	0
R								
W	Bit 7	Bit 6	Bit 5	Bit 4	Bit 3	Bit 2	Bit 1	Bit 0
POR or non- end-run	0	0	0	0	0	0	0	0
Reset end-run ¹	U	U	U	U	U	U	U	U

Figure 18-5. Debug Comparator B Low Register (DBGCBL)

¹ In the case of an end-trace to reset where DBGGEN=1 and BEGIN=0, the bits in this register do not change after reset.

Table 18-6. DBGCBL Field Descriptions

Field	Description
Bits 7–0	<p>Comparator B Low Compare Bits — The Comparator B Low compare bits control whether Comparator B will compare the address bus or data bus bits [7:0] to a logic 1 or logic 0.</p> <p>0 Compare corresponding address bit to a logic 0, compares to data if in Full mode</p> <p>1 Compare corresponding address bit to a logic 1, compares to data if in Full mode</p>

18.3.3.5 Debug Comparator C High Register (DBGCCCH)

Module Base + 0x0004

	7	6	5	4	3	2	1	0
R								
W								
	Bit 15	Bit 14	Bit 13	Bit 12	Bit 11	Bit 10	Bit 9	Bit 8
POR or non-end-run	0	0	0	0	0	0	0	0
Reset end-run ¹	U	U	U	U	U	U	U	U

Figure 18-6. Debug Comparator C High Register (DBGCCCH)

¹ In the case of an end-trace to reset where DBGGEN=1 and BEGIN=0, the bits in this register do not change after reset.

Table 18-7. DBGCCCH Field Descriptions

Field	Description
Bits 15–8	<p>Comparator C High Compare Bits — The Comparator C High compare bits control whether Comparator C will compare the address bus bits [15:8] to a logic 1 or logic 0.</p> <p>0 Compare corresponding address bit to a logic 0</p> <p>1 Compare corresponding address bit to a logic 1</p>

18.3.3.6 Debug Comparator C Low Register (DBGCCCL)

Module Base + 0x0005

	7	6	5	4	3	2	1	0
R	Bit 7	Bit 6	Bit 5	Bit 4	Bit 3	Bit 2	Bit 1	Bit 0
W								
POR or non-end-run	0	0	0	0	0	0	0	0
Reset end-run ¹	U	U	U	U	U	U	U	U

Figure 18-7. Debug Comparator C Low Register (DBGCCCL)

¹ In the case of an end-trace to reset where DBGGEN=1 and BEGIN=0, the bits in this register do not change after reset.

Table 18-8. DBGCCCL Field Descriptions

Field	Description
Bits 7–0	Comparator C Low Compare Bits — The Comparator C Low compare bits control whether Comparator C will compare the address bus bits [7:0] to a logic 1 or logic 0. 0 Compare corresponding address bit to a logic 0 1 Compare corresponding address bit to a logic 1

18.3.3.7 Debug FIFO High Register (DBGFHH)

Module Base + 0x0006

	7	6	5	4	3	2	1	0
R	Bit 15	Bit 14	Bit 13	Bit 12	Bit 11	Bit 10	Bit 9	Bit 8
W								
POR or non-end-run	0	0	0	0	0	0	0	0
Reset end-run ¹	U	U	U	U	U	U	U	U

= Unimplemented or Reserved

Figure 18-8. Debug FIFO High Register (DBGFHH)

¹ In the case of an end-trace to reset where DBGGEN=1 and BEGIN=0, the bits in this register do not change after reset.

Table 18-9. DBGFH Field Descriptions

Field	Description
Bits 15–8	FIFO High Data Bits — The FIFO High data bits provide access to bits [15:8] of data in the FIFO. This register is not used in event only modes and will read a \$00 for valid FIFO words.

18.3.3.8 Debug FIFO Low Register (DBGFL)

Module Base + 0x0007

	7	6	5	4	3	2	1	0
R	Bit 7	Bit 6	Bit 5	Bit 4	Bit 3	Bit 2	Bit 1	Bit 0
W								
POR or non- end-run	0	0	0	0	0	0	0	0
Reset end-run ¹	U	U	U	U	U	U	U	U

= Unimplemented or Reserved

Figure 18-9. Debug FIFO Low Register (DBGFL)

¹ In the case of an end-trace to reset where DBGGEN=1 and BEGIN=0, the bits in this register do not change after reset.

Table 18-10. DBGFL Field Descriptions

Field	Description
Bits 7–0	FIFO Low Data Bits — The FIFO Low data bits contain the least significant byte of data in the FIFO. When reading FIFO words, read DBGFX and DBGFH before reading DBGFL because reading DBGFL causes the FIFO pointers to advance to the next FIFO location. In event-only modes, there is no useful information in DBGFX and DBGFH so it is not necessary to read them before reading DBGFL.

18.3.3.9 Debug Comparator A Extension Register (DBGCAx)

Module Base + 0x0008

	7	6	5	4	3	2	1	0
R	RWAEN	RWA	PAGSEL	0	0	0	0	Bit 16
W								
POR or non-end-run	0	0	0	0	0	0	0	0
Reset end-run ¹	U	U	U	0	0	0	0	U

= Unimplemented or Reserved

Figure 18-10. Debug Comparator A Extension Register (DBGCAx)

¹ In the case of an end-trace to reset where DBGGEN=1 and BEGIN=0, the bits in this register do not change after reset.

Table 18-11. DBGCAx Field Descriptions

Field	Description
7 RWAEN	Read/Write Comparator A Enable Bit — The RWAEN bit controls whether read or write comparison is enabled for Comparator A. 0 Read/Write is not used in comparison 1 Read/Write is used in comparison
6 RWA	Read/Write Comparator A Value Bit — The RWA bit controls whether read or write is used in compare for Comparator A. The RWA bit is not used if RWAEN = 0. 0 Write cycle will be matched 1 Read cycle will be matched
5 PAGSEL	Comparator A Page Select Bit — This PAGSEL bit controls whether Comparator A will be qualified with the internal signal (mmu_ppage_sel) that indicates an extended access through the PPAGE mechanism. When mmu_ppage_sel = 1, the 17-bit core address is a paged program access, and the 17-bit core address is made up of PPAGE[2:0]:addr[13:0]. When mmu_ppage_sel = 0, the 17-bit core address is either a 16-bit CPU address with a leading 0 in bit 16, or a 17-bit linear address pointer value. 0 Match qualified by mmu_ppage_sel = 0 so address bits [16:0] correspond to a 17-bit CPU address with a leading zero at bit 16, or a 17-bit linear address pointer address 1 Match qualified by mmu_ppage_sel = 1 so address bits [16:0] compare to flash memory address made up of PPAGE[2:0]:addr[13:0]
0 Bit 16	Comparator A Extended Address Bit 16 Compare Bit — The Comparator A bit 16 compare bit controls whether Comparator A will compare the core address bus bit 16 to a logic 1 or logic 0. 0 Compare corresponding address bit to a logic 0 1 Compare corresponding address bit to a logic 1

18.3.3.10 Debug Comparator B Extension Register (DBGCBX)

Module Base + 0x0009

	7	6	5	4	3	2	1	0
R	RWBEN	RWB	PAGSEL	0	0	0	0	Bit 16
W								
POR or non-end-run	0	0	0	0	0	0	0	0
Reset end-run ¹	U	U	U	0	0	0	0	U

= Unimplemented or Reserved

Figure 18-11. Debug Comparator B Extension Register (DBGCBX)

¹ In the case of an end-trace to reset where DBGGEN=1 and BEGIN=0, the bits in this register do not change after reset.

Table 18-12. DBGCBX Field Descriptions

Field	Description
7 RWBEN	Read/Write Comparator B Enable Bit — The RWBEN bit controls whether read or write comparison is enabled for Comparator B. In full modes, RWAEN and RWA are used to control comparison of R/W and RWBEN is ignored. 0 Read/Write is not used in comparison 1 Read/Write is used in comparison
6 RWB	Read/Write Comparator B Value Bit — The RWB bit controls whether read or write is used in compare for Comparator B. The RWB bit is not used if RWBEN = 0. In full modes, RWAEN and RWA are used to control comparison of R/W and RWB is ignored. 0 Write cycle will be matched 1 Read cycle will be matched
5 PAGSEL	Comparator B Page Select Bit — This PAGSEL bit controls whether Comparator B will be qualified with the internal signal (mmu_ppage_sel) that indicates an extended access through the PPAGE mechanism. When mmu_ppage_sel = 1, the 17-bit core address is a paged program access, and the 17-bit core address is made up of PPAGE[2:0]:addr[13:0]. When mmu_ppage_sel = 0, the 17-bit core address is either a 16-bit CPU address with a leading 0 in bit 16, or a 17-bit linear address pointer value. This bit is not used in full modes where comparator B is used to match the data value. 0 Match qualified by mmu_ppage_sel = 0 so address bits [16:0] correspond to a 17-bit CPU address with a leading zero at bit 16, or a 17-bit linear address pointer address 1 Match qualified by mmu_ppage_sel = 1 so address bits [16:0] compare to flash memory address made up of PPAGE[2:0]:addr[13:0]
0 Bit 16	Comparator B Extended Address Bit 16 Compare Bit — The Comparator B bit 16 compare bit controls whether Comparator B will compare the core address bus bit 16 to a logic 1 or logic 0. This bit is not used in full modes where comparator B is used to match the data value. 0 Compare corresponding address bit to a logic 0 1 Compare corresponding address bit to a logic 1

18.3.3.11 Debug Comparator C Extension Register (DBGCCX)

Module Base + 0x000A

	7	6	5	4	3	2	1	0
R	RWCEN	RWC	PAGSEL	0	0	0	0	Bit 16
W								
POR or non-end-run	0	0	0	0	0	0	0	0
Reset end-run ¹	U	U	U	0	0	0	0	U

= Unimplemented or Reserved

Figure 18-12. Debug Comparator C Extension Register (DBGCCX)

¹ In the case of an end-trace to reset where DBGGEN=1 and BEGIN=0, the bits in this register do not change after reset.

Table 18-13. DBGCCX Field Descriptions

Field	Description
7 RWCEN	Read/Write Comparator C Enable Bit — The RWCEN bit controls whether read or write comparison is enabled for Comparator C. 0 Read/Write is not used in comparison 1 Read/Write is used in comparison
6 RWC	Read/Write Comparator C Value Bit — The RWC bit controls whether read or write is used in compare for Comparator C. The RWC bit is not used if RWCEN = 0. 0 Write cycle will be matched 1 Read cycle will be matched
5 PAGSEL	Comparator C Page Select Bit — This PAGSEL bit controls whether Comparator C will be qualified with the internal signal (mmu_ppage_sel) that indicates an extended access through the PPAGE mechanism. When mmu_ppage_sel = 1, the 17-bit core address is a paged program access, and the 17-bit core address is made up of PPAGE[2:0]:addr[13:0]. When mmu_ppage_sel = 0, the 17-bit core address is either a 16-bit CPU address with a leading 0 in bit 16, or a 17-bit linear address pointer value. 0 Match qualified by mmu_ppage_sel = 0 so address bits [16:0] correspond to a 17-bit CPU address with a leading zero at bit 16, or a 17-bit linear address pointer address 1 Match qualified by mmu_ppage_sel = 1 so address bits [16:0] compare to flash memory address made up of PPAGE[2:0]:addr[13:0]
0 Bit 16	Comparator C Extended Address Bit 16 Compare Bit — The Comparator C bit 16 compare bit controls whether Comparator C will compare the core address bus bit 16 to a logic 1 or logic 0. 0 Compare corresponding address bit to a logic 0 1 Compare corresponding address bit to a logic 1

18.3.3.12 Debug FIFO Extended Information Register (DBGFX)

Module Base + 0x000B

	7	6	5	4	3	2	1	0
R	PPACC	0	0	0	0	0	0	Bit 16
W								
POR or non- end-run	0	0	0	0	0	0	0	0
Reset end-run ¹	U	0	0	0	0	0	0	U

= Unimplemented or Reserved

Figure 18-13. Debug FIFO Extended Information Register (DBGFX)

¹ In the case of an end-trace to reset where DBGGEN=1 and BEGIN=0, the bits in this register do not change after reset.

Table 18-14. DBGFX Field Descriptions

Field	Description
7 PPACC	PPAGE Access Indicator Bit — This bit indicates whether the captured information in the current FIFO word is associated with an extended access through the PPAGE mechanism or not. This is indicated by the internal signal mmu_ppage_sel which is 1 when the access is through the PPAGE mechanism. 0 The information in the corresponding FIFO word is event-only data or an unpagged 17-bit CPU address with bit-16 = 0 1 The information in the corresponding FIFO word is a 17-bit flash address with PPAGE[2:0] in the three most significant bits and CPU address[13:0] in the 14 least significant bits
0 Bit 16	Extended Address Bit 16 — This bit is the most significant bit of the 17-bit core address.

18.3.3.13 Debug Control Register (DBGC)

Module Base + 0x000C

	7	6	5	4	3	2	1	0
R	DBGEN	ARM	TAG	BRKEN	0	0	0	LOOP1
W								
POR or non-end-run	1	1	0	0	0	0	0	0
Reset end-run ¹	U	0	U	0	0	0	0	U

= Unimplemented or Reserved

Figure 18-14. Debug Control Register (DBGC)

¹ In the case of an end-trace to reset where DBGEN=1 and BEGIN=0, the ARM and BRKEN bits are cleared but the remaining control bits in this register do not change after reset.

Table 18-15. DBGC Field Descriptions

Field	Description
7 DBGEN	DBG Module Enable Bit — The DBGEN bit enables the DBG module. The DBGEN bit is forced to zero and cannot be set if the MCU is secure. 0 DBG not enabled 1 DBG enabled
6 ARM	Arm Bit — The ARM bit controls whether the debugger is comparing and storing data in FIFO. See Section 18.4.4.2, “Arming the DBG Module” for more information. 0 Debugger not armed 1 Debugger armed
5 TAG	Tag or Force Bit — The TAG bit controls whether a debugger or comparator C breakpoint will be requested as a tag or force breakpoint to the CPU. The TAG bit is not used if BRKEN = 0. 0 Force request selected 1 Tag request selected
4 BRKEN	Break Enable Bit — The BRKEN bit controls whether the debugger will request a breakpoint to the CPU at the end of a trace run, and whether comparator C will request a breakpoint to the CPU. 0 CPU break request not enabled 1 CPU break request enabled
0 LOOP1	Select LOOP1 Capture Mode — This bit selects either normal capture mode or LOOP1 capture mode. LOOP1 is not used in event-only modes. 0 Normal operation - capture COF events into the capture buffer FIFO 1 LOOP1 capture mode enabled. When the conditions are met to store a COF value into the FIFO, compare the current COF address with the address in comparator C. If these addresses match, override the FIFO capture and do not increment the FIFO count. If the address does not match comparator C, capture the COF address, including the PPACC indicator, into the FIFO and into comparator C.

18.3.3.14 Debug Trigger Register (DBGT)

Module Base + 0x000D

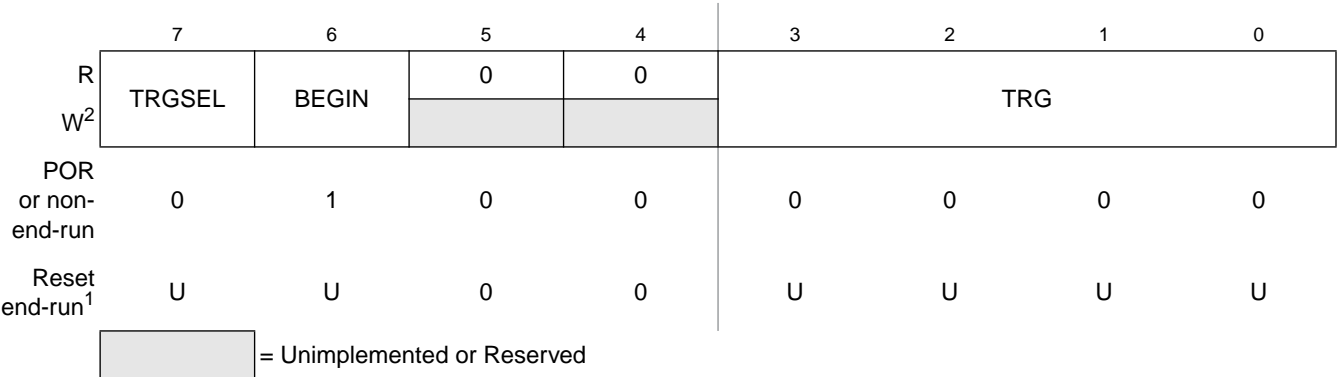

Figure 18-15. Debug Trigger Register (DBGT)

¹ In the case of an end-trace to reset where DBGEN=1 and BEGIN=0, the control bits in this register do not change after reset.
² The DBG trigger register (DBGT) can not be changed unless ARM=0.

Table 18-16. DBGT Field Descriptions

Field	Description
7 TRGSEL	Trigger Selection Bit — The TRGSEL bit controls the triggering condition for the comparators. See Section 18.4.4, “Trigger Break Control (TBC)” for more information. 0 Trigger on any compare address access 1 Trigger if opcode at compare address is executed
6 BEGIN	Begin/End Trigger Bit — The BEGIN bit controls whether the trigger begins or ends storing of data in FIFO. 0 Trigger at end of stored data 1 Trigger before storing data
3–0 TRG	Trigger Mode Bits — The TRG bits select the trigger mode of the DBG module as shown in Table 18-17 .

Table 18-17. Trigger Mode Encoding

TRG Value	Meaning
0000	A Only
0001	A Or B
0010	A Then B
0011	Event Only B
0100	A Then Event Only B
0101	A And B (Full Mode)
0110	A And Not B (Full mode)
0111	Inside Range
1000	Outside Range

Table 18-17. Trigger Mode Encoding

TRG Value	Meaning
1001 ↓ 1111	No Trigger

NOTE

The DBG trigger register (DBGT) can not be changed unless ARM=0.

18.3.3.15 Debug Status Register (DBGS)

Module Base + 0x000E

	7	6	5	4	3	2	1	0
R	AF	BF	CF	0	0	0	0	ARMF
W								
POR or non-end-run	0	0	0	0	0	0	0	1
Reset end-run ¹	U	U	U	0	0	0	0	0

= Unimplemented or Reserved

Figure 18-16. Debug Status Register (DBGS)

¹ In the case of an end-trace to reset where DBGEN=1 and BEGIN=0, ARMF gets cleared by reset but AF, BF, and CF do not change after reset.

Table 18-18. DBGS Field Descriptions

Field	Description
7 AF	Trigger A Match Bit — The AF bit indicates if Trigger A match condition was met since arming. 0 Comparator A did not match 1 Comparator A match
6 BF	Trigger B Match Bit — The BF bit indicates if Trigger B match condition was met since arming. 0 Comparator B did not match 1 Comparator B match
5 CF	Trigger C Match Bit — The CF bit indicates if Trigger C match condition was met since arming. 0 Comparator C did not match 1 Comparator C match
0 ARMF	Arm Flag Bit — The ARMF bit indicates whether the debugger is waiting for trigger or waiting for the FIFO to fill. While DBGEN = 1, this status bit is a read-only image of the ARM bit in DBGCR. See Section 18.4.4.2, “Arming the DBG Module” for more information. 0 Debugger not armed 1 Debugger armed

18.3.3.16 Debug Count Status Register (DBGCNT)

Module Base + 0x000F

	7	6	5	4	3	2	1	0
R	0	0	0	0	CNT			
W								
POR or non-end-run	0	0	0	0	0	0	0	0
Reset end-run ¹	0	0	0	0	U	U	U	U

= Unimplemented or Reserved

Figure 18-17. Debug Count Status Register (DBGCNT)

¹ In the case of an end-trace to reset where DBGEN=1 and BEGIN=0, the CNT[3:0] bits do not change after reset.

Table 18-19. DBGS Field Descriptions

Field	Description
3–0 CNT	FIFO Valid Count Bits — The CNT bits indicate the amount of valid data stored in the FIFO. Table 18-20 shows the correlation between the CNT bits and the amount of valid data in FIFO. The CNT will stop after a count to eight even if more data is being stored in the FIFO. The CNT bits are cleared when the DBG module is armed, and the count is incremented each time a new word is captured into the FIFO. The host development system is responsible for checking the value in CNT[3:0] and reading the correct number of words from the FIFO because the count does not decrement as data is read out of the FIFO at the end of a trace run.

Table 18-20. CNT Bits

CNT Value	Meaning
0000	No data valid
0001	1 word valid
0010	2 words valid
0011	3 words valid
0100	4 words valid
0101	5 words valid
0110	6 words valid
0111	7 words valid
1000	8 words valid

18.4 Functional Description

This section provides a complete functional description of the on-chip ICE system. The DBG module is enabled by setting the DBGGEN bit in the DBGCR register. Enabling the module allows the arming, triggering and storing of data in the FIFO. The DBG module is made up of three main blocks, the Comparators, Trigger Break Control logic and the FIFO.

18.4.1 Comparator

The DBG module contains three comparators, A, B, and C. Comparator A compares the core address bus with the address stored in the DBGCAAX, DBGCAH, and DBGCAL registers. Comparator B compares the core address bus with the address stored in the DBGCBX, DBGCBH, and DBGCBL registers except in full mode, where it compares the data buses to the data stored in the DBGCBL register. Comparator C compares the core address bus with the address stored in the DBGCCX, DBGCCCH, and DBGCCCL registers. Matches on Comparators A, B, and C are signaled to the Trigger Break Control (TBC) block.

18.4.1.1 RWA and RWAEN in Full Modes

In full modes ("A And B" and "A And Not B") RWAEN and RWA are used to select read or write comparisons for both comparators A and B. To select write comparisons and the write data bus in Full Modes set RWAEN=1 and RWA=0, otherwise read comparisons and the read data bus will be selected. The RWBEN and RWB bits are not used and will be ignored in Full Modes.

18.4.1.2 Comparator C in LOOP1 Capture Mode

Normally comparator C is used as a third hardware breakpoint and is not involved in the trigger logic for the on-chip ICE system. In this mode, it compares the core address bus with the address stored in the DBGCCX, DBGCCCH, and DBGCCCL registers. However, in LOOP1 capture mode, comparator C is managed by logic in the DBG module to track the address of the most recent change-of-flow event that was captured into the FIFO buffer. In LOOP1 capture mode, comparator C is not available for use as a normal hardware breakpoint.

When the ARM and DBGGEN bits are set to one in LOOP1 capture mode, comparator C value registers are cleared to prevent the previous contents of these registers from interfering with the LOOP1 capture mode operation. When a COF event is detected, the address of the event is compared to the contents of the DBGCCX, DBGCCCH, and DBGCCCL registers to determine whether it is the same as the previous COF entry in the capture FIFO. If the values match, the capture is inhibited to prevent the FIFO from filling up with duplicate entries. If the values do not match, the COF event is captured into the FIFO and the DBGCCX, DBGCCCH, and DBGCCCL registers are updated to reflect the address of the captured COF event. When comparator C is updated, the PAGSEL bit (bit-7 of DBGCCX) is updated with the PPACC value that is captured into the FIFO. This bit indicates whether the COF address was a paged 17-bit program address using the PPAGE mechanism (PPACC=1) or a 17-bit CPU address that resulted from an unpaged CPU access.

18.4.2 Breakpoints

A breakpoint request to the CPU at the end of a trace run can be created if the BRKEN bit in the DBGCR register is set. The value of the BEGIN bit in DBGTR register determines when the breakpoint request to the CPU will occur. If the BEGIN bit is set, begin-trigger is selected and the breakpoint request will not occur until the FIFO is filled with 8 words. If the BEGIN bit is cleared, end-trigger is selected and the breakpoint request will occur immediately at the trigger cycle.

When traditional hardware breakpoints from comparators A or B are desired, set BEGIN=0 to select an end-trace run and set the trigger mode to either 0x0 (A-only) or 0x1 (A OR B) mode.

There are two types of breakpoint requests supported by the DBG module, tag-type and force-type. Tagged breakpoints are associated with opcode addresses and allow breaking just before a specific instruction executes. Force breakpoints are not associated with opcode addresses and allow breaking at the next instruction boundary. The TAG bit in the DBGCR register determines whether CPU breakpoint requests will be a tag-type or force-type breakpoints. When TAG=0, a force-type breakpoint is requested and it will take effect at the next instruction boundary after the request. When TAG=1, a tag-type breakpoint is registered into the instruction queue and the CPU will break if/when this tag reaches the head of the instruction queue and the tagged instruction is about to be executed.

18.4.2.1 Hardware Breakpoints

Comparators A, B, and C can be used as three traditional hardware breakpoints whether the on-chip ICE real-time capture function is required or not. To use any breakpoint or trace run capture functions set DBGCR=1. BRKEN and TAG affect all three comparators. When BRKEN=0, no CPU breakpoints are enabled. When BRKEN=1, CPU breakpoints are enabled and the TAG bit determines whether the breakpoints will be tag-type or force-type breakpoints. To use comparators A and B as hardware breakpoints, set DBGTR=0x81 for tag-type breakpoints and 0x01 for force-type breakpoints. This sets up an end-type trace with trigger mode “A OR B”.

Comparator C is not involved in the trigger logic for the on-chip ICE system.

18.4.3 Trigger Selection

The TRGSEL bit in the DBGTR register is used to determine the triggering condition of the on-chip ICE system. TRGSEL applies to both trigger A and B except in the event only trigger modes. By setting the TRGSEL bit, the comparators will qualify a match with the output of opcode tracking logic. The opcode tracking logic is internal to each comparator and determines whether the CPU executed the opcode at the compare address. With the TRGSEL bit cleared a comparator match is all that is necessary for a trigger condition to be met.

NOTE

If the TRGSEL is set, the address stored in the comparator match address registers must be an opcode address for the trigger to occur.

18.4.4 Trigger Break Control (TBC)

The TBC is the main controller for the DBG module. Its function is to decide whether data should be stored in the FIFO based on the trigger mode and the match signals from the comparator. The TBC also determines whether a request to break the CPU should occur.

The TAG bit in DBGCR controls whether CPU breakpoints are treated as tag-type or force-type breakpoints. The TRGSEL bit in DBGTR controls whether a comparator A or B match is further qualified by opcode tracking logic. Each comparator has a separate circuit to track opcodes because the comparators could correspond to separate instructions that could be propagating through the instruction queue at the same time.

In end-type trace runs (BEGIN=0), when the comparator registers match, including the optional R/W match, this signal goes to the CPU break logic where BRKEN determines whether a CPU break is requested and the TAG control bit determines whether the CPU break will be a tag-type or force-type breakpoint. When TRGSEL is set, the R/W qualified comparator match signal also passes through the opcode tracking logic. If/when it propagates through this logic, it will cause a trigger to the ICE logic to begin or end capturing information into the FIFO. In the case of an end-type (BEGIN=0) trace run, the qualified comparator signal stops the FIFO from capturing any more information.

If a CPU breakpoint is also enabled, you would want TAG and TRGSEL to agree so that the CPU break occurs at the same place in the application program as the FIFO stopped capturing information. If TRGSEL was 0 and TAG was 1 in an end-type trace run, the FIFO would stop capturing as soon as the comparator address matched, but the CPU would continue running until a TAG signal could propagate through the CPU's instruction queue which could take a long time in the case where changes of flow caused the instruction queue to be flushed. If TRGSEL was one and TAG was zero in an end-type trace run, the CPU would break before the comparator match signal could propagate through the opcode tracking logic to end the trace run.

In begin-type trace runs (BEGIN=1), the start of FIFO capturing is triggered by the qualified comparator signals, and the CPU breakpoint (if enabled by BRKEN=1) is triggered when the FIFO becomes full. Since this FIFO full condition does not correspond to the execution of a tagged instruction, it would not make sense to use TAG=1 for a begin-type trace run.

18.4.4.1 Begin- and End-Trigger

The definition of begin- and end-trigger as used in the DBG module are as follows:

- Begin-trigger: Storage in FIFO occurs after the trigger and continues until 8 locations are filled.
- End-trigger: Storage in FIFO occurs until the trigger with the least recent data falling out of the FIFO if more than 8 words are collected.

18.4.4.2 Arming the DBG Module

Arming occurs by enabling the DBG module by setting the DBGEN bit and by setting the ARM bit in the DBGCR register. The ARM bit in the DBGCR register and the ARMF bit in the DBGSR register are cleared when the trigger condition is met in end-trigger mode or when the FIFO is filled in begin-trigger mode. In the case of an end-trace where DBGEN=1 and BEGIN=0, ARM and ARMF are cleared by any reset to

end the trace run that was in progress. The ARMF bit is also cleared if ARM is written to zero or when the DBGEN bit is low. The TBC logic determines whether a trigger condition has been met based on the trigger mode and the trigger selection.

18.4.4.3 Trigger Modes

The on-chip ICE system supports nine trigger modes. The trigger modes are encoded as shown in [Table 18-17](#). The trigger mode is used as a qualifier for either starting or ending the storing of data in the FIFO. When the match condition is met, the appropriate flag AF or BF is set in DBGS register. Arming the DBG module clears the AF, BF, and CF flags in the DBGS register. In all trigger modes except for the event only modes change of flow addresses are stored in the FIFO. In the event only modes only the value on the data bus at the trigger event B comparator match address will be stored.

18.4.4.3.1 A Only

In the A Only trigger mode, if the match condition for A is met, the AF flag in the DBGS register is set.

18.4.4.3.2 A Or B

In the A Or B trigger mode, if the match condition for A or B is met, the corresponding flag(s) in the DBGS register are set.

18.4.4.3.3 A Then B

In the A Then B trigger mode, the match condition for A must be met before the match condition for B is compared. When the match condition for A or B is met, the corresponding flag in the DBGS register is set.

18.4.4.3.4 Event Only B

In the Event Only B trigger mode, if the match condition for B is met, the BF flag in the DBGS register is set. The Event Only B trigger mode is considered a begin-trigger type and the BEGIN bit in the DBGTT register is ignored.

18.4.4.3.5 A Then Event Only B

In the A Then Event Only B trigger mode, the match condition for A must be met before the match condition for B is compared. When the match condition for A or B is met, the corresponding flag in the DBGS register is set. The A Then Event Only B trigger mode is considered a begin-trigger type and the BEGIN bit in the DBGTT register is ignored.

18.4.4.3.6 A And B (Full Mode)

In the A And B trigger mode, Comparator A compares to the address bus and Comparator B compares to the data bus. In the A and B trigger mode, if the match condition for A and B happen on the same bus cycle, both the AF and BF flags in the DBGS register are set. If a match condition on only A or only B happens, no flags are set.

For Breakpoint tagging operation with an end-trigger type trace, only matches from Comparator A will be used to determine if the Breakpoint conditions are met and Comparator B matches will be ignored.

18.4.4.3.7 A And Not B (Full Mode)

In the A And Not B trigger mode, comparator A compares to the address bus and comparator B compares to the data bus. In the A And Not B trigger mode, if the match condition for A and Not B happen on the same bus cycle, both the AF and BF flags in the DBGS register are set. If a match condition on only A or only Not B occur no flags are set.

For Breakpoint tagging operation with an end-trigger type trace, only matches from Comparator A will be used to determine if the Breakpoint conditions are met and Comparator B matches will be ignored.

18.4.4.3.8 Inside Range, $A \leq \text{address} \leq B$

In the Inside Range trigger mode, if the match condition for A and B happen on the same bus cycle, both the AF and BF flags in the DBGS register are set. If a match condition on only A or only B occur no flags are set.

18.4.4.3.9 Outside Range, $\text{address} < A$ or $\text{address} > B$

In the Outside Range trigger mode, if the match condition for A or B is met, the corresponding flag in the DBGS register is set.

The four control bits BEGIN and TRGSEL in DBGTT, and BRKEN and TAG in DBGCC, determine the basic type of debug run as shown in Table 1.21. Some of the 16 possible combinations are not used (refer to the notes at the end of the table).

Table 18-21. Basic Types of Debug Runs

BEGIN	TRGSEL	BRKEN	TAG	Type of Debug Run
0	0	0	x ⁽¹⁾	Fill FIFO until trigger address (No CPU breakpoint - keep running)
0	0	1	0	Fill FIFO until trigger address, then force CPU breakpoint
0	0	1	1	Do not use ⁽²⁾
0	1	0	x ⁽¹⁾	Fill FIFO until trigger opcode about to execute (No CPU breakpoint - keep running)
0	1	1	0	Do not use ⁽³⁾
0	1	1	1	Fill FIFO until trigger opcode about to execute (trigger causes CPU breakpoint)
1	0	0	x ⁽¹⁾	Start FIFO at trigger address (No CPU breakpoint - keep running)
1	0	1	0	Start FIFO at trigger address, force CPU breakpoint when FIFO full
1	0	1	1	Do not use ⁽⁴⁾
1	1	0	x ⁽¹⁾	Start FIFO at trigger opcode (No CPU breakpoint - keep running)
1	1	1	0	Start FIFO at trigger opcode, force CPU breakpoint when FIFO full
1	1	1	1	Do not use ⁽⁴⁾

¹ When BRKEN = 0, TAG is do not care (x in the table).

² In end trace configurations (BEGIN = 0) where a CPU breakpoint is enabled (BRKEN = 1), TRGSEL should agree with TAG. In this case, where TRGSEL = 0 to select no opcode tracking qualification and TAG = 1 to specify a tag-type CPU breakpoint, the CPU breakpoint would not take effect until sometime after the FIFO stopped storing values. Depending on program loops or interrupts, the delay could be very long.

³ In end trace configurations (BEGIN = 0) where a CPU breakpoint is enabled (BRKEN = 1), TRGSEL should agree with TAG. In this case, where TRGSEL = 1 to select opcode tracking qualification and TAG = 0 to specify a force-type CPU breakpoint, the CPU breakpoint would erroneously take effect before the FIFO stopped storing values and the debug run would not complete normally.

⁴ In begin trace configurations (BEGIN = 1) where a CPU breakpoint is enabled (BRKEN = 1), TAG should not be set to 1. In begin trace debug runs, the CPU breakpoint corresponds to the FIFO full condition which does not correspond to a taggable instruction fetch.

18.4.5 FIFO

The FIFO is an eight word deep FIFO. In all trigger modes except for event only, the data stored in the FIFO will be change of flow addresses. In the event only trigger modes only the data bus value corresponding to the event is stored. In event only trigger modes, the high byte of the valid data from the FIFO will always read a 0x00 and the extended information byte in DBGFX will always read 0x00.

18.4.5.1 Storing Data in FIFO

In all trigger modes except for the event only modes, the address stored in the FIFO will be determined by the change of flow indicators from the core. The signal `core_cof[1]` indicates the current core address is the destination address of an indirect JSR or JMP instruction, or a RTS, RTC, or RTI instruction or interrupt vector and the destination address should be stored. The signal `core_cof[0]` indicates that a conditional branch was taken and that the source address of the conditional branch should be stored.

18.4.5.2 Storing with Begin-Trigger

Storing with Begin-Trigger can be used in all trigger modes. Once the DBG module is enabled and armed in the begin-trigger mode, data is not stored in the FIFO until the trigger condition is met. Once the trigger condition is met the DBG module will remain armed until 8 words are stored in the FIFO. If the `core_cof[1]` signal becomes asserted, the current address is stored in the FIFO. If the `core_cof[0]` signal becomes asserted, the address registered during the previous last cycle is decremented by two and stored in the FIFO.

18.4.5.3 Storing with End-Trigger

Storing with End-Trigger cannot be used in event-only trigger modes. Once the DBG module is enabled and armed in the end-trigger mode, data is stored in the FIFO until the trigger condition is met. If the `core_cof[1]` signal becomes asserted, the current address is stored in the FIFO. If the `core_cof[0]` signal becomes asserted, the address registered during the previous last cycle is decremented by two and stored in the FIFO. When the trigger condition is met, the ARM and ARMF will be cleared and no more data will be stored. In non-event only end-trigger modes, if the trigger is at a change of flow address the trigger event will be stored in the FIFO.

18.4.5.4 Reading Data from FIFO

The data stored in the FIFO can be read using BDM commands provided the DBG module is enabled and not armed (DBGEN=1 and ARM=0). The FIFO data is read out first-in-first-out. By reading the CNT bits

in the DBGCNT register at the end of a trace run, the number of valid words can be determined. The FIFO data is read by optionally reading the DBGFX and DBGFH registers followed by the DBGFL register. Each time the DBGFL register is read the FIFO is shifted to allow reading of the next word however the count does not decrement. In event-only trigger modes where the FIFO will contain only the data bus values stored, to read the FIFO only DBGFL needs to be accessed.

The FIFO is normally only read while ARM and ARMF=0, however reading the FIFO while the DBG module is armed will return the data value in the oldest location of the FIFO and the TBC will not allow the FIFO to shift. This action could cause a valid entry to be lost because the unexpected read blocked the FIFO advance.

If the DBG module is not armed and the DBGFL register is read, the TBC will store the current opcode address. Through periodic reads of the DBGFX, DBGFH, and DBGFL registers while the DBG module is not armed, host software can provide a histogram of program execution. This is called profile mode. Since the full 17-bit address and the signal that indicates whether an address is in paged extended memory are captured on each FIFO store, profile mode works correctly over the entire extended memory map.

18.4.6 Interrupt Priority

When TRGSEL is set and the DBG module is armed to trigger on begin- or end-trigger types, a trigger is not detected in the condition where a pending interrupt occurs at the same time that a target address reaches the top of the instruction pipe. In these conditions, the pending interrupt has higher priority and code execution switches to the interrupt service routine.

When TRGSEL is clear and the DBG module is armed to trigger on end-trigger types, the trigger event is detected on a program fetch of the target address, even when an interrupt becomes pending on the same cycle. In these conditions, the pending interrupt has higher priority, the exception is processed by the core and the interrupt vector is fetched. Code execution is halted before the first instruction of the interrupt service routine is executed. In this scenario, the DBG module will have cleared ARM without having recorded the change-of-flow that occurred as part of the interrupt exception. Note that the stack will hold the return addresses and can be used to reconstruct execution flow in this scenario.

When TRGSEL is clear and the DBG module is armed to trigger on begin-trigger types, the trigger event is detected on a program fetch of the target address, even when an interrupt becomes pending on the same cycle. In this scenario, the FIFO captures the change of flow event. Because the system is configured for begin-trigger, the DBG remains armed and does not break until the FIFO has been filled by subsequent change of flow events.

18.5 Resets

The DBG module cannot cause an MCU reset.

There are two different ways this module will respond to reset depending upon the conditions before the reset event. If the DBG module was setup for an end trace run with DBGGEN=1 and BEGIN=0, ARM, ARMF, and BRKEN are cleared but the reset function on most DBG control and status bits is overridden so a host development system can read out the results of the trace run after the MCU has been reset. In all other cases including POR, the DBG module controls are initialized to start a begin trace run starting from when the reset vector is fetched. The conditions for the default begin trace run are:

- $DBGCAx=0x00$, $DBGCAH=0xFF$, $DBGCAL=0xFE$ so comparator A is set to match when the 16-bit CPU address $0xFFFFE$ appears during the reset vector fetch
- $DBGC=0xC0$ to enable and arm the DBG module
- $DBGT=0x40$ to select a force-type trigger, a BEGIN trigger, and A-only trigger mode

18.6 Interrupts

The DBG contains no interrupt source.

18.7 Electrical Specifications

The DBG module contain no electrical specifications.

Appendix A

Electrical Characteristics

A.1 Introduction

This section contains the most accurate electrical and timing information for the MC9S08DZ128 Series of microcontrollers available at the time of publication.

A.2 Parameter Classification

The electrical parameters shown in this supplement are guaranteed by various methods. To give the customer a better understanding the following classification is used and the parameters are tagged accordingly in the tables where appropriate:

Table A-1. Parameter Classifications

P	Those parameters are guaranteed during production testing on each individual device.
C	Those parameters are achieved by the design characterization by measuring a statistically relevant sample size across process variations.
T	Those parameters are achieved by design characterization on a small sample size from typical devices under typical conditions unless otherwise noted. All values shown in the typical column are within this category.
D	Those parameters are derived mainly from simulations.

NOTE

The classification is shown in the column labeled “C” in the parameter tables where appropriate.

A.3 Absolute Maximum Ratings

Absolute maximum ratings are stress ratings only, and functional operation at the maxima is not guaranteed. Stress beyond the limits specified in [Table A-2](#) may affect device reliability or cause permanent damage to the device. For functional operating conditions, refer to the remaining tables in this section.

This device contains circuitry protecting against damage due to high static voltage or electrical fields; however, it is advised that normal precautions be taken to avoid application of any voltages higher than

maximum-rated voltages to this high-impedance circuit. Reliability of operation is enhanced if unused inputs are tied to an appropriate logic voltage level (for instance, either V_{SS} or V_{DD}).

Table A-2. Absolute Maximum Ratings

Num	Rating	Symbol	Value	Unit
1	Supply voltage	V_{DD}	-0.3 to + 5.8	V
2	Input voltage	V_{In}	- 0.3 to $V_{DD} + 0.3$	V
3	Instantaneous maximum current Single pin limit (applies to all port pins) ^{1, 2, 3}	I_D	± 25	mA
4	Maximum current into V_{DD}	I_{DD}	120	mA
5	Storage temperature	T_{stg}	-55 to +150	°C

- ¹ Input must be current limited to the value specified. To determine the value of the required current-limiting resistor, calculate resistance values for positive (V_{DD}) and negative (V_{SS}) clamp voltages, then use the larger of the two resistance values.
- ² All functional non-supply pins are internally clamped to V_{SS} and V_{DD} .
- ³ Power supply must maintain regulation within operating V_{DD} range during instantaneous and operating maximum current conditions. If positive injection current ($V_{In} > V_{DD}$) is greater than I_{DD} , the injection current may flow out of V_{DD} and could result in external power supply going out of regulation. Ensure external V_{DD} load will shunt current greater than maximum injection current. This will be the greatest risk when the MCU is not consuming power. Examples are: if no system clock is present, or if the clock rate is very low which would reduce overall power consumption.

A.4 Thermal Characteristics

This section provides information about operating temperature range, power dissipation, and package thermal resistance. Power dissipation on I/O pins is usually small compared to the power dissipation in on-chip logic and it is user-determined rather than being controlled by the MCU design. In order to take $P_{I/O}$ into account in power calculations, determine the difference between actual pin voltage and V_{SS} or V_{DD} and multiply by the pin current for each I/O pin. Except in cases of unusually high pin current (heavy loads), the difference between pin voltage and V_{SS} or V_{DD} will be very small.

Table A-3. Thermal Characteristics

Num	C	Rating	Symbol	Value	Unit	
1	D	Operating temperature range (packaged)	T_A	T_L to T_H	°C	
				P^1		-40 to 85
				V		-40 to 105
				M		-40 to 125
2	T	Maximum junction temperature	T_J	135		
3	D	Thermal resistance ^{2,3} Single-layer board		θ_{JA}	°C/W	
		100-pin LQFP	61			
		64-pin LQFP	67			
		48-pin LQFP	75			
4	D	Thermal resistance ^{2,3} Four-layer board		θ_{JA}	°C/W	
		100-pin LQFP	48			
		64-pin LQFP	49			
		48-pin LQFP	52			

¹ Freescale may eliminate a test insertion at a particular temperature from the production test flow once sufficient data has been collected and is approved.

² Junction temperature is a function of die size, on-chip power dissipation, package thermal resistance, mounting site (board) temperature, ambient temperature, air flow, power dissipation of other components on the board, and board thermal resistance.

³ Junction to Ambient Natural Convection

The average chip-junction temperature (T_J) in °C can be obtained from:

$$T_J = T_A + (P_D \times \theta_{JA}) \quad \text{Eqn. A-1}$$

where:

T_A = Ambient temperature, °C

θ_{JA} = Package thermal resistance, junction-to-ambient, °C/W

$P_D = P_{int} + P_{I/O}$

$P_{int} = I_{DD} \times V_{DD}$, Watts — chip internal power

$P_{I/O}$ = Power dissipation on input and output pins — user determined

For most applications, $P_{I/O} \ll P_{int}$ and can be neglected. An approximate relationship between P_D and T_J (if $P_{I/O}$ is neglected) is:

$$P_D = K \div (T_J + 273^\circ\text{C}) \quad \text{Eqn. A-2}$$

Solving equations 1 and 2 for K gives:

$$K = P_D \times (T_A + 273^\circ\text{C}) + \theta_{JA} \times (P_D)^2 \quad \text{Eqn. A-3}$$

where K is a constant pertaining to the particular part. K can be determined from equation 3 by measuring P_D (at equilibrium) for a known T_A . Using this value of K, the values of P_D and T_J can be obtained by solving equations 1 and 2 iteratively for any value of T_A .

A.5 ESD Protection and Latch-Up Immunity

Although damage from electrostatic discharge (ESD) is much less common on these devices than on early CMOS circuits, normal handling precautions should be used to avoid exposure to static discharge. Qualification tests are performed to ensure that these devices can withstand exposure to reasonable levels of static without suffering any permanent damage.

All ESD testing is in conformity with AEC-Q100 Stress Test Qualification for Automotive Grade Integrated Circuits. During the device qualification ESD stresses were performed for the Human Body Model (HBM) and the Charge Device Model (CDM).

A device is defined as a failure if after exposure to ESD pulses the device no longer meets the device specification. Complete DC parametric and functional testing is performed per the applicable device specification at room temperature followed by hot temperature, unless specified otherwise in the device specification.

Table A-4. ESD and Latch-up Test Conditions

Model	Description	Symbol	Value	Unit
Human Body	Series Resistance	R1	1500	Ω
	Storage Capacitance	C	100	pF
	Number of Pulse per pin	—	3	
Latch-up	Minimum input voltage limit	—	-2.5	V
	Maximum input voltage limit	—	7.5	V

Table A-5. ESD and Latch-Up Protection Characteristics

Num	Rating ¹	Symbol	Min	Max	Unit
1	Human Body Model (HBM)	V_{HBM}	± 2000	—	V
2	Charge Device Model (CDM)	V_{CDM}	± 500	—	V
3	Latch-up Current at $T_A = 125^\circ\text{C}$	I_{LAT}	± 100	—	mA

¹ Parameter is achieved by design characterization on a small sample size from typical devices under typical conditions unless otherwise noted.

A.6 DC Characteristics

This section includes information about power supply requirements, I/O pin characteristics, and power supply current in various operating modes.

Table A-6. DC Characteristics

Num	C	Characteristic	Symbol	Condition	Min	Typ ¹	Max	Unit	
1	—	Operating voltage	V_{DD}	—	2.7	—	5.5	V	
2	C	Output high voltage	V_{OH}	All I/O pins, low-drive strength	5 V, $I_{Load} = -4$ mA	$V_{DD} - 1.5$	—	—	V
	P			5 V, $I_{Load} = -2$ mA	$V_{DD} - 0.8$	—	—		
	C	3 V, $I_{Load} = -1$ mA		$V_{DD} - 0.8$	—	—			
	C	All I/O pins, high-drive strength		5 V, $I_{Load} = -20$ mA	$V_{DD} - 1.5$	—	—		
	P	5 V, $I_{Load} = -10$ mA		$V_{DD} - 0.8$	—	—			
	C	3 V, $I_{Load} = -5$ mA		$V_{DD} - 0.8$	—	—			
3	D	Output high current Max total I_{OH} for all ports	I_{OHT}	$V_{OUT} < V_{DD}$	0	—	-100	mA	
4	C	Output low voltage	V_{OL}	All I/O pins low-drive strength	5 V, $I_{Load} = 4$ mA	—	—	1.5	V
	P			5 V, $I_{Load} = 2$ mA	—	—	0.8		
	C	3 V, $I_{Load} = 1$ mA		—	—	0.8			
	C	All I/O pins high-drive strength		5 V, $I_{Load} = 20$ mA	—	—	1.5		
	P	5 V, $I_{Load} = 10$ mA		—	—	0.8			
	C	3 V, $I_{Load} = 5$ mA		—	—	0.8			
5	C	Output low current Max total I_{OL} for all ports	I_{OLT}	$V_{OUT} > V_{SS}$	0	—	100	mA	
6	P	Input high voltage; all digital inputs	V_{IH}	5V	$0.65 \times V_{DD}$	—	—	V	
	C			3V	$0.7 \times V_{DD}$	—	—		
7	P	Input low voltage; all digital inputs	V_{IL}	5V	—	—	$0.35 \times V_{DD}$	V	
	C			3V	—	—	$0.35 \times V_{DD}$		
8	C	Input hysteresis	V_{hys}		$0.06 \times V_{DD}$			V	
9	P	Input leakage current (per pin)	$ I_{In} $	$V_{In} = V_{DD}$ or V_{SS}	—	0.1	1	μA	
10	P	Hi-Z (off-state) leakage current (per pin) input/output port pins PTG1/XTAL/PTE1/ ³	$ I_{OZ} $	$V_{In} = V_{DD}$ or V_{SS} ,	—	0.1	1	μA	
				$V_{In} = V_{DD}$ or V_{SS}	—	0.2	2	μA	
11	P	Pullup or Pulldown ² resistors; when enabled I/O pins	R_{PU}, R_{PD}			17	37	52	k Ω
	C			PTE1/ ³	R_{PU}		17	37	52
12	D	DC injection current ^{4, 5, 6, 7} Single pin limit	I_{IC}	$V_{IN} > V_{DD}$	0	—	2	mA	
				$V_{IN} < V_{SS}$,	0	—	-0.2	mA	
		Total MCU limit, includes sum of all stressed pins		$V_{IN} > V_{DD}$	0	—	25	mA	
				$V_{IN} < V_{SS}$,	0	—	-5	mA	
13	D	Input Capacitance, all pins	C_{In}		—	—	8	pF	

Table A-6. DC Characteristics (continued)

Num	C	Characteristic	Symbol	Condition	Min	Typ ¹	Max	Unit	
14	D	RAM retention voltage	V_{RAM}		—	0.6	1.0	V	
15	D	POR re-arm voltage ⁸	V_{POR}		0.9	1.4	2.0	V	
16	D	POR re-arm time ⁹	t_{POR}		10	—	—	μ s	
17	P	Low-voltage detection threshold — high range	V_{LVD1}		V_{DD} falling	3.9	4.0	4.1	V
					V_{DD} rising	4.0	4.1	4.2	
18	P	Low-voltage detection threshold — low range	V_{LVD0}		V_{DD} falling	2.48	2.56	2.64	V
					V_{DD} rising	2.54	2.62	2.70	
19	P	Low-voltage warning threshold — high range 1	V_{LVW3}		V_{DD} falling	4.5	4.6	4.7	V
					V_{DD} rising	4.6	4.7	4.8	
20	P	Low-voltage warning threshold — high range 0	V_{LVW2}		V_{DD} falling	4.2	4.3	4.4	V
					V_{DD} rising	4.3	4.4	4.5	
21	P	Low-voltage warning threshold low range 1	V_{LVW1}		V_{DD} falling	2.84	2.92	3.00	V
					V_{DD} rising	2.90	2.98	3.06	
22	P	Low-voltage warning threshold — low range 0	V_{LVW0}		V_{DD} falling	2.66	2.74	2.82	V
					V_{DD} rising	2.72	2.80	2.88	
23	T	Low-voltage inhibit reset/recover hysteresis	V_{Ivihys}	5 V	—	100	—	mV	
				3 V	—	60	—		
24	P	Bandgap Voltage Reference ¹⁰	V_{BG}		1.19	1.20	1.21	V	

¹ Typical values are measured at 25°C. Characterized, not tested.

² When a pin interrupt is configured to detect rising edges, pulldown resistors are used in place of pullup resistors.

³ The specified resistor value is the actual value internal to the device. The pullup value may measure higher when measured externally on the pin.

⁴ Power supply must maintain regulation within operating V_{DD} range during instantaneous and operating maximum current conditions. If positive injection current ($V_{in} > V_{DD}$) is greater than I_{DD} , the injection current may flow out of V_{DD} and could result in external power supply going out of regulation. Ensure external V_{DD} load will shunt current greater than maximum injection current. This will be the greatest risk when the MCU is not consuming power. Examples are: if no system clock is present, or if clock rate is very low (which would reduce overall power consumption).

⁵ All functional non-supply pins are internally clamped to V_{SS} and V_{DD} .

⁶ Input must be current limited to the value specified. To determine the value of the required current-limiting resistor, calculate resistance values for positive and negative clamp voltages, then use the larger of the two values.

⁷ The PTE1_{pin} does not have a clamp diode to V_{DD} . Do not drive this pin above V_{DD} .

⁸ Maximum is highest voltage that POR will occur.

⁹ Simulated, not tested

¹⁰ Factory trimmed at $V_{DD} = 5.0$ V, Temp = 25°C

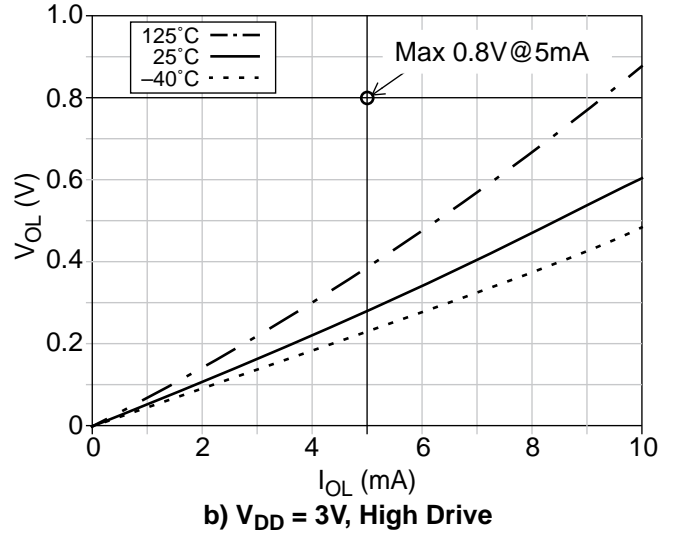
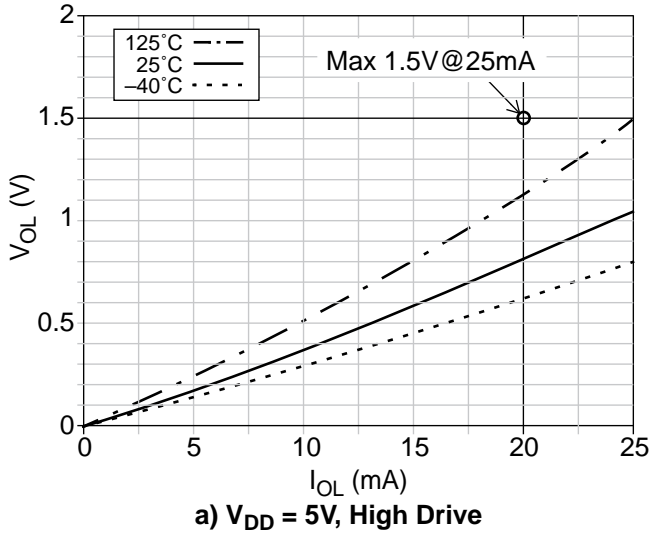

Figure A-1. Typical V_{OL} vs I_{OL} , High Drive Strength

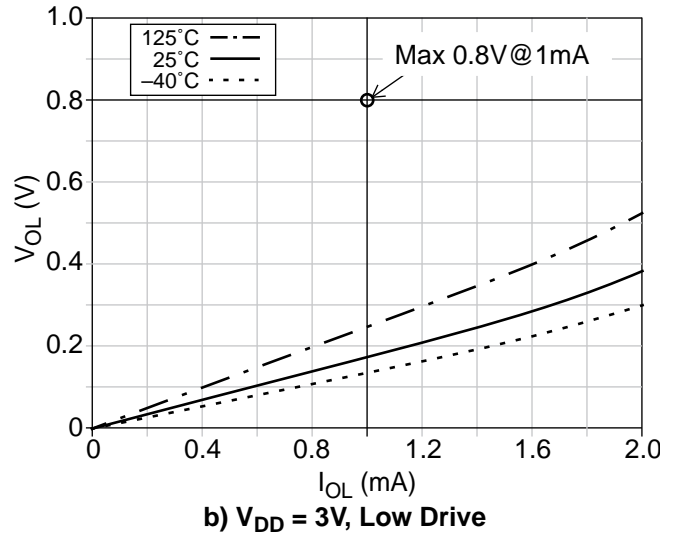
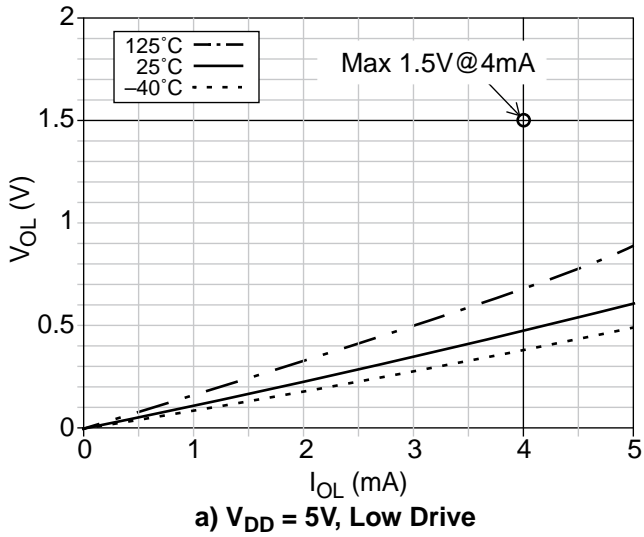

Figure A-2. Typical V_{OL} vs I_{OL} , Low Drive Strength

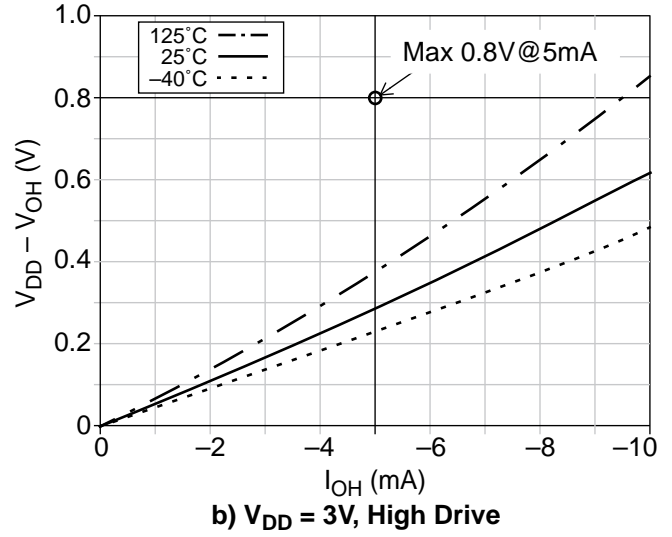
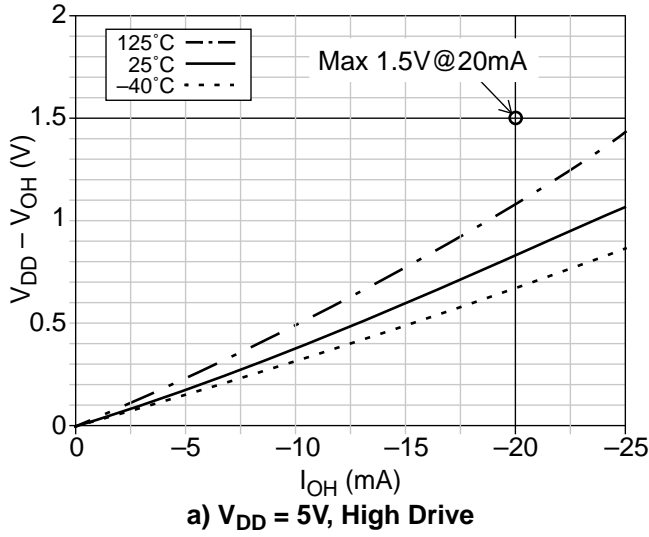

Figure A-3. Typical $V_{DD} - V_{OH}$ vs I_{OH} , High Drive Strength

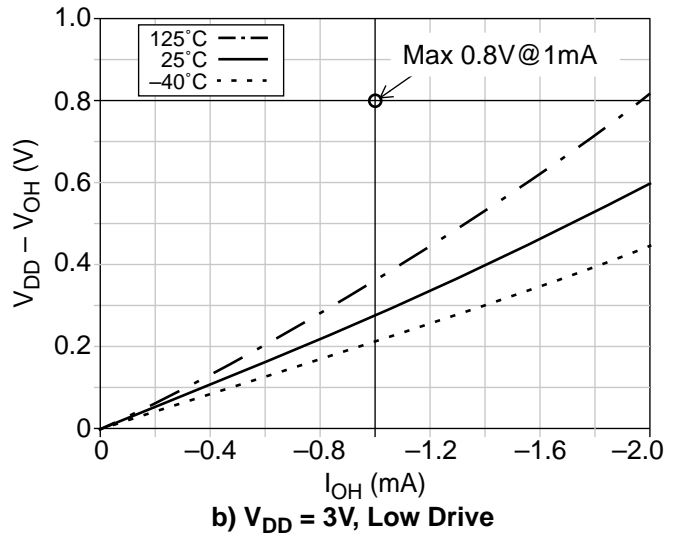
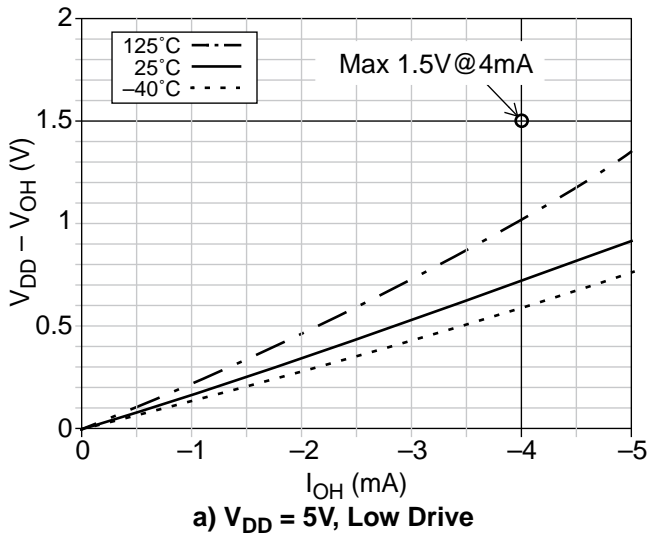

Figure A-4. Typical $V_{DD} - V_{OH}$ vs I_{OH} , Low Drive Strength

A.7 Supply Current Characteristics

This section includes information about power supply current in various operating modes.

Table A-7. Supply Current Characteristics

Num	C	Parameter	Symbol	V _{DD} (V)	Typ ¹	Max ²	Unit
1	C	Run supply current ³ measured at (CPU clock = 2 MHz, f _{Bus} = 1 MHz)	R _I DD	5	2.1	3 ⁴	mA
	C			3	2.0	2.5	
2	C	Run supply current ³ measured at (CPU clock = 16 MHz, f _{Bus} = 8 MHz)	R _I DD	5	8.4	9 ⁴	4.6
	C			3	8.3	8.7	
3	P	Run supply current ⁴ measured at (CPU clock = 40 MHz, f _{Bus} = 20MHz)	R _I DD	5	17.9	24	mA
	C			3	17.8	23	
Stop3 mode supply current							
4	C	-40°C (C,V, & M suffix) 25°C (All parts) 85°C (C suffix only) 105°C (V suffix only) 125°C (M suffix only)	S ₃ I _{DD}	5	0.7	—	μA
	P				1.1	—	
	p ⁵				14.8	18.5	
	p ⁵				38.8	49	
	p ⁵				172	257	
	C	-40°C (C,V, & M suffix) 25°C (All parts) 85°C (C suffix only) 105°C (V suffix only) 125°C (M suffix only)	S ₃ I _{DD}	3	0.34	—	μA
	P				0.79	—	
	p ⁵				12.7	15	
	p ⁵				33.6	42.4	
	p ⁵				159	208	
Stop2 mode supply current							
5	C	-40°C (C,M, & V suffix) 25°C (All parts) 85°C (C suffix only) 105°C (V suffix only) 125°C (M suffix only)	S ₂ I _{DD}	5	0.65	—	μA
	P				0.94	—	
	p ⁵				11.3	14	
	p ⁵				29.7	37.4	
	p ⁵				140	220	
	C	-40°C (C,M, & V suffix) 25°C (All parts) 85°C (C suffix only) 105°C (V suffix only) 125°C (M suffix only)	S ₂ I _{DD}	3	0.33	—	μA
	P				0.69	—	
	p ⁵				9.4	11.6	
	p ⁵				25	31.3	
	p ⁵				95	155	
6	P	RTC adder to stop2 or stop3 ⁶	S ₂₃ I _{DDRTI}	5	300	500	nA
	P			3	300	500	nA
7	P	LVD adder to stop3 (LVDE = LVDSE = 1)	S ₃ I _{DDLVD}	5	110	180	μA
	P			3	90	160	μA

Table A-7. Supply Current Characteristics (continued)

Num	C	Parameter	Symbol	V _{DD} (V)	Typ ¹	Max ²	Unit
8	P	Adder to stop3 for oscillator enabled ⁷ (EREFSTEN =1)	S3I _{DDOSC}	5	5	8	μA
	3			5	8		

- ¹ Typical are measured at 25°C. See [Figure A-8](#) through [Figure A-10](#) for typical curves across voltage/temperature.
- ² Max values in this column apply for the full operating temperature range of the device unless otherwise noted.
- ³ All modules except ADC active, ICS configured for FBE, and does not include any dc loads on port pins
- ⁴ All modules except ADC active, ICS configured for FEI, and does not include any dc loads on port pins
- ⁵ Stop currents are tested in production for 25°C on all parts. Tests at other temperatures depend upon the part number suffix and maturity of the product. Freescale may eliminate a test insertion at a particular temperature from the production test flow once sufficient data has been collected and approved.
- ⁶ Most customers are expected to find that auto-wakeup from stop2 or stop3 can be used instead of the higher current wait mode.
- ⁷ Values given under the following conditions: low range operation (RANGE = 0) with a 32.768kHz crystal and low power mode (HGO = 0).

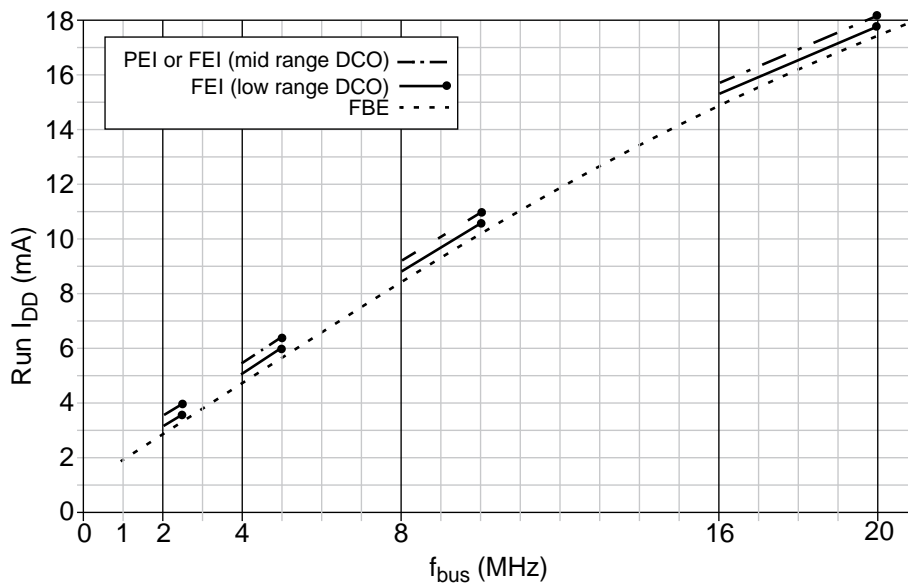
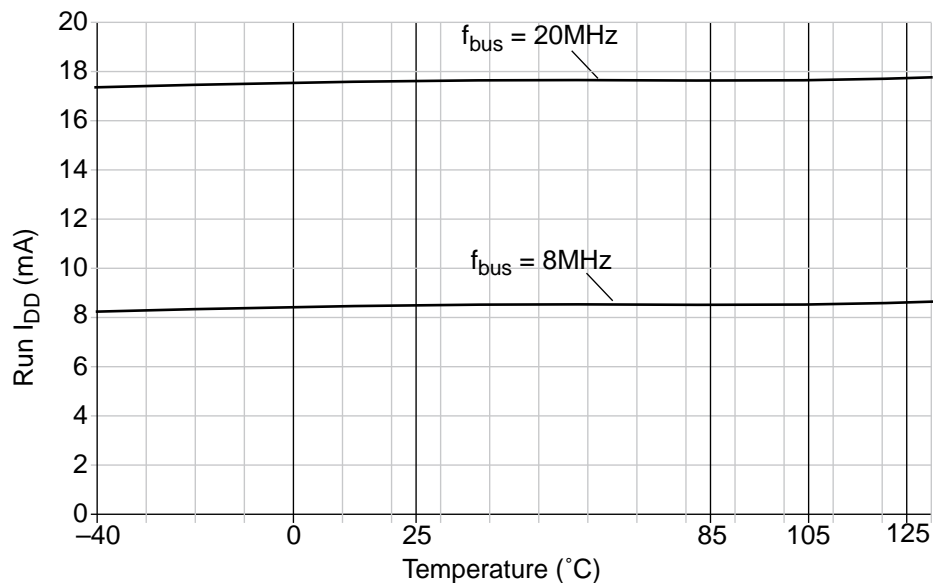
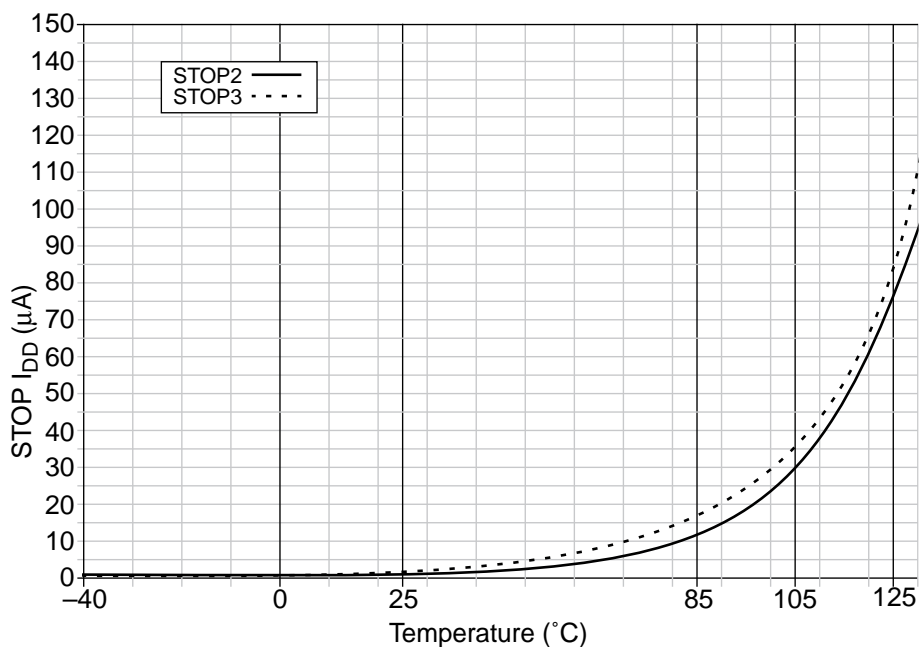

Figure A-5. Typical Run I_{DD} vs. Bus Frequency (V_{DD} = 5V)

 Figure A-6. Typical Run I_{DD} vs. Temperature ($V_{DD} = 5V$)

 Figure A-7. Typical Stop I_{DD} vs. Temperature ($V_{DD} = 5V$)

A.8 Analog Comparator (ACMP) Electricals

Table A-8. Analog Comparator Electrical Specifications

Num	C	Rating	Symbol	Min	Typical	Max	Unit
1	—	Supply voltage	V_{DD}	2.7	—	5.5	V

Table A-8. Analog Comparator Electrical Specifications

Num	C	Rating	Symbol	Min	Typical	Max	Unit
2	D	Supply current (active)	I_{DDAC}	—	20	35	μA
3	D	Analog input voltage	V_{AIN}	$V_{SS} - 0.3$	—	V_{DD}	V
4	D	Analog input offset voltage	V_{AIO}		20	40	mV
5	D	Analog Comparator hysteresis	V_H	3.0	6.0	20.0	mV
6	D	Analog input leakage current	I_{ALKG}	--	--	1.0	μA
7	D	Analog Comparator initialization delay	t_{AINIT}	—	—	1.0	μs

A.9 ADC Characteristics

Table A-9. 5 Volt 12-bit ADC Operating Conditions

Characteristic	Conditions	Symb	Min	Typ ¹	Max	Unit	Comment
Supply voltage	Absolute	V_{DDA}	2.7	—	5.5	V	
	Delta to V_{DD} ($V_{DD}-V_{DDA}$) ²	ΔV_{DDA}	-100	0	+100	mV	
Ground voltage	Delta to V_{SS} ($V_{SS}-V_{SSA}$) ²	ΔV_{SSA}	-100	0	+100	mV	
Ref Voltage High		V_{REFH}	2.7	V_{DDA}	V_{DDA}	V	• Applicable only in 100-pin and 64-pin packages.
Ref Voltage Low		V_{REFL}	V_{SSA}	V_{SSA}	V_{SSA}	V	• Applicable only in 100-pin and 64-pin packages.
Input Voltage		V_{ADIN}	V_{REFL}	—	V_{REFH}	V	
Input Capacitance		C_{ADIN}	—	4.5	5.5	pF	
Input Resistance		R_{ADIN}	—	3	5	k Ω	
Analog Source Resistance	12 bit mode $f_{ADCK} > 4\text{MHz}$ $f_{ADCK} < 4\text{MHz}$	R_{AS}	—	—	2	k Ω	External to MCU
	10 bit mode $f_{ADCK} > 4\text{MHz}$ $f_{ADCK} < 4\text{MHz}$		—	—	5		
	8 bit mode (all valid f_{ADCK})		—	—	10		
ADC Conversion Clock Freq.	High Speed (ADLPC=0)	f_{ADCK}	0.4	—	8.0	MHz	
	Low Power (ADLPC=1)		0.4	—	4.0		

¹ Typical values assume $V_{DDAD} = 5.0\text{V}$, $\text{Temp} = 25\text{C}$, $f_{ADCK} = 1.0\text{MHz}$ unless otherwise stated. Typical values are for reference only and are not tested in production.

² DC potential difference.

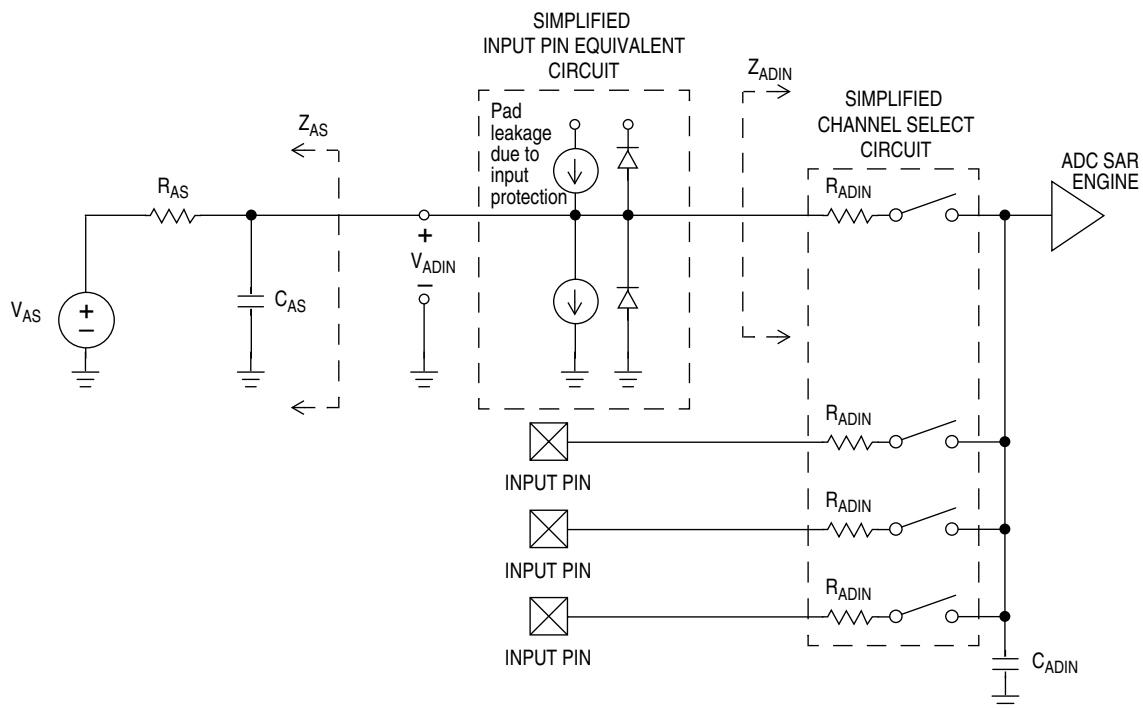

Figure A-8. ADC Input Impedance Equivalency Diagram

Table A-10. 5 Volt 12-bit ADC Characteristics ($V_{REFH} = V_{DDA}$, $V_{REFL} = V_{SSA}$)

Characteristic	Conditions	C	Symb	Min	Typ ¹	Max	Unit	Comment
Supply Current ADLPC=1 ADLSMP=1 ADCO=1		T	I_{DDAD}	—	133	—	μA	
Supply Current ADLPC=1 ADLSMP=0 ADCO=1		T	I_{DDAD}	—	218	—	μA	
Supply Current ADLPC=0 ADLSMP=1 ADCO=1		T	I_{DDAD}	—	327	—	μA	
Supply Current ADLPC=0 ADLSMP=0 ADCO=1		T	I_{DDAD}	—	0.582	1	mA	
Supply Current	Stop, Reset, Module Off	T	I_{DDAD}	—	0.011	1	μA	
ADC Asynchronous Clock Source	High Speed (ADLPC=0)	D	f_{ADACK}	2	3.3	5	MHz	$t_{ADACK} = 1/f_{ADACK}$
	Low Power (ADLPC=1)			1.25	2	3.3		
Conversion Time (Including sample time)	Short Sample (ADLSMP=0)	D	t_{ADC}	—	20	—	ADCK cycles	See the ADC Chapter for conversion time variances
	Long Sample (ADLSMP=1)			—	40	—		
Sample Time	Short Sample (ADLSMP=0)	D	t_{ADS}	—	3.5	—	ADCK cycles	
	Long Sample (ADLSMP=1)			—	23.5	—		
Total Unadjusted Error	12 bit mode	T	E_{TUE}	—	± 3.0	± 10	LSB ²	Includes quantization
	10 bit mode	P		—	± 1	± 2.5		
	8 bit mode	T		—	± 0.5	± 1.0		
Differential Non-Linearity	12 bit mode	T	DNL	—	± 1.75	± 4.0	LSB ²	
	10 bit mode ³	P		—	± 0.5	± 1.0		
	8 bit mode ³	T		—	± 0.3	± 0.5		
Integral Non-Linearity	12 bit mode	T	INL	—	± 1.5	± 4.0	LSB ²	
	10 bit mode	P		—	± 0.5	± 1.0		
	8 bit mode	T		—	± 0.3	± 0.5		
Zero-Scale Error	12 bit mode	C	E_{ZS}	—	± 1.5	± 6.0	LSB ²	$V_{ADIN} = V_{SSAD}$
	10 bit mode	P		—	± 0.5	± 1.5		
	8 bit mode	T		—	± 0.5	± 0.5		

Table A-10. 5 Volt 12-bit ADC Characteristics ($V_{REFH} = V_{DDA}$, $V_{REFL} = V_{SSA}$) (continued)

Characteristic	Conditions	C	Symb	Min	Typ ¹	Max	Unit	Comment
Full-Scale Error	12 bit mode	T	E_{FS}	—	± 1	± 4.0	LSB ²	$V_{ADIN} = V_{DDAD}$
	10 bit mode	T		—	± 0.5	± 1		
	8 bit mode	T		—	± 0.5	± 0.5		
Quantization Error	12 bit mode	D	E_Q	—	-1 to 0	-1 to 0	LSB ²	
	10 bit mode			—	—	± 0.5		
	8 bit mode			—	—	± 0.5		
Input Leakage Error	12 bit mode	D	E_{IL}	—	± 1	± 10.0	LSB ²	Pad leakage ^{4*} R_{AS}
	10 bit mode			—	± 0.2	± 2.5		
	8 bit mode			—	± 0.1	± 1		
Temp Sensor Slope	-40°C– 25°C	D	m	—	3.266	—	mV/°C	
	25°C– 125°C			—	3.638	—		
Temp Sensor Voltage	25°C	D	V_{TEMP25}	—	1.396	—	V	

¹ Typical values assume $V_{DDAD} = 5.0V$, Temp = 25C, $f_{ADCK} = 1.0MHz$ unless otherwise stated. Typical values are for reference only and are not tested in production.

² $1 \text{ LSB} = (V_{REFH} - V_{REFL})/2^N$

³ Monotonicity and No-Missing-Codes guaranteed in 10 bit and 8 bit modes

⁴ Based on input pad leakage current. Refer to pad electricals.

A.10 External Oscillator (XOSC) Characteristics

Table A-11. Oscillator Electrical Specifications (Temperature Range = -40 to 125°C Ambient)

Num	C	Rating	Symbol	Min	Typ ¹	Max	Unit
1	C	Oscillator crystal or resonator (EREFS = 1, ERCLKEN = 1)					
		Low range (RANGE = 0)	f_{lo}	32	—	38.4	kHz
		High range (RANGE = 1) FEE or FBE mode ²	f_{hi-ll}	1	—	5	MHz
		High range (RANGE = 1) PEE or PBE mode ³	f_{hi-pll}	1	—	16	MHz
		High range (RANGE = 1, HGO = 1) BLPE mode	f_{hi-hgo}	1	—	16	MHz
		High range (RANGE = 1, HGO = 0) BLPE mode	f_{hi-lp}	1	—	8	MHz
2	—	Load capacitors	C_1 C_2	See crystal or resonator manufacturer's recommendation.			
3	—	Feedback resistor	R_F				
		Low range (32 kHz to 38.4 kHz)		—	10	—	MΩ
		High range (1 MHz to 16 MHz)		—	1	—	MΩ
4	—	Series resistor	R_S				
		Low range, low gain (RANGE = 0, HGO = 0)		—	0	—	kΩ
		Low range, high gain (RANGE = 0, HGO = 1)		—	100	—	
		High range, low gain (RANGE = 1, HGO = 0)		—	0	—	
		High range, high gain (RANGE = 1, HGO = 1)					
≥ 8 MHz	—	0	0				
4 MHz	—	0	10				
1 MHz	—	0	20				
5	T	Crystal start-up time ⁴					
		Low range, low gain (RANGE = 0, HGO = 0)	$t_{CSTL-LP}$	—	200	—	ms
		Low range, high gain (RANGE = 0, HGO = 1)	$t_{CSTL-HGO}$	—	400	—	
		High range, low gain (RANGE = 1, HGO = 0) ⁵	$t_{CSTH-LP}$	—	5	—	
High range, high gain (RANGE = 1, HGO = 1) ⁵	$t_{CSTH-HGO}$	—	20	—			
6	T	Square wave input clock frequency (EREFS = 0, ERCLKEN = 1)					
		FEE or FBE mode ²	f_{extal}	0.03125	—	5	MHz
		PEE or PBE mode ³		1	—	16	
		BLPE mode		0	—	40	

¹ Data in Typical column was characterized at 3.0 V, 25°C or is typical recommended value.

² When MCG is configured for FEE or FBE mode, input clock source must be divisible using RDIV to within the range of 31.25 kHz to 39.0625 kHz.

³ When MCG is configured for PEE or PBE mode, input clock source must be divisible using RDIV to within the range of 1 MHz to 2 MHz.

⁴ This parameter is characterized and not tested on each device. Proper PC board layout procedures must be followed to achieve specifications. This data varies based on crystal manufacturer and board design. The crystal should be characterized by the crystal manufacturer.

⁵ 4 MHz crystal

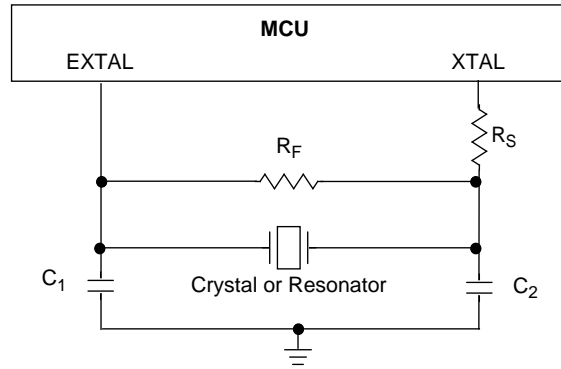

A.11 MCG Specifications

Table A-12. MCG Frequency Specifications (Temperature Range = -40 to 125°C Ambient)

Num	C	Rating	Symbol	Min	Typical	Max	Unit	
1	P	Internal reference frequency - factory trimmed at VDD=5.0V and temperature=25C	f_{int_ft}	—	31.25	—	kHz	
2	P	Internal reference frequency - untrimmed ¹	f_{int_ut}	25	36	41.66	kHz	
3	P	Internal reference frequency - user trimmed	f_{int_t}	31.25	—	39.0625	kHz	
4	D	Internal reference startup time	t_{irefst}	—	55	100	us	
5	—	DCO output frequency range - untrimmed ¹	f_{dco_ut}	Low range (DRS=0, DMX32=0) $f_{dco_ut} = 512X f_{int_ut}$	12.8	18.43	21.33	MHz
	—			Mid range (DRS=1, DMX32=0) $f_{dco_ut} = 1024 X f_{int_ut}$	25.6	36.86	42.66	
6	P	DCO output frequency range - trimmed ²	f_{dco_t}	Low range (DRS=0, DMX32=0) $f_{dco_ut} = 512X f_{int_ut}$	16	—	20	MHz
	P			Mid range (DRS=1, DMX32=0) $f_{dco_ut} = 1024 X f_{int_ut}$	32	—	40	
7	C	Resolution of trimmed DCO output frequency at fixed voltage and temperature (using FTRIM)	$\Delta f_{dco_res_t}$	—	± 0.1	± 0.2	% f_{dco}	
8	C	Resolution of trimmed DCO output frequency at fixed voltage and temperature (not using FTRIM)	$\Delta f_{dco_res_t}$	—	± 0.2	± 0.4	% f_{dco}	
9	P	Total deviation of trimmed DCO output frequency over voltage and temperature	Δf_{dco_t}	—	+ 0.5 -1.0	± 2	% f_{dco}	
10	C	Total deviation of trimmed DCO output frequency over fixed voltage and temperature range of 0 - 70 °C	Δf_{dco_t}	—	± 0.5	± 1	% f_{dco}	
11	C	FLL acquisition time ³	$t_{fill_acquire}$	—	—	1	ms	
12	D	PLL acquisition time ⁴	$t_{pll_acquire}$	—	—	1	ms	
13	C	Long term Jitter of DCO output clock (averaged over 2mS interval) ⁵	C_{jitter}	—	0.02	0.2	% f_{dco}	
14	D	VCO operating frequency	f_{vco}	7.0	—	55.0	MHz	

Table A-12. MCG Frequency Specifications (Temperature Range = -40 to 125°C Ambient) (continued)

Num	C	Rating	Symbol	Min	Typical	Max	Unit
15	D	PLL reference frequency range	$f_{\text{pll_ref}}$	1.0	—	2.0	MHz
16	T	RMS frequency variation of a single clock cycle measured 2 ms after reference edge. ⁶	$f_{\text{pll_cycjit_2ms}}$	—	0.590 ⁵	—	% f_{pll}
17	T	Maximum frequency variation averaged over 2 ms window.	$f_{\text{pll_maxjit_2ms}}$	—	0.001	—	% f_{pll}
18	T	RMS frequency variation of a single clock cycle measured 625 ns after reference edge. ⁷	$f_{\text{pll_cycjit_625ns}}$	—	0.566 ⁵	—	% f_{pll}
19	T	Maximum frequency variation averaged over 625 ns window.	$f_{\text{pll_maxjit_625ns}}$	—	0.113	—	% f_{pll}
20	D	Lock entry frequency tolerance ⁸	D_{lock}	± 1.49	—	± 2.98	%
21	D	Lock exit frequency tolerance ⁹	D_{unl}	± 4.47	—	± 5.97	%
22	D	Lock time - FLL	$t_{\text{fl_lock}}$	—	—	$t_{\text{fl_acquire}} + 1075(1/f_{\text{int_t}})$	s

¹ This applies when TRIM register at value (0x80) and FTRIM control bit at value (0x0). These values load when in BDM modes.

² The resulting bus clock frequency should not exceed the maximum specified bus clock frequency of the device.

³ This specification applies to any time the FLL reference source or reference divider is changed, trim value is changed, DMX32 bit is changed, DRS bit is changed, or changing from FLL disabled (BLPE, BLPI) to FLL enabled (FEI, FEE, FBE, FBI). If a crystal/resonator is being used as the reference, this specification assumes it is already running.

⁴ This specification applies to any time the PLL VCO divider or reference divider is changed, or changing from PLL disabled (BLPE, BLPI) to PLL enabled (PBE, PEE). If a crystal/resonator is being used as the reference, this specification assumes it is already running.

⁵ Jitter is the average deviation from the programmed frequency measured over the specified interval at maximum f_{BUS} . Measurements are made with the device powered by filtered supplies and clocked by a stable external clock signal. Noise injected into the FLL circuitry via V_{DD} and V_{SS} and variation in crystal oscillator frequency increase the C_{Jitter} percentage for a given interval. These jitter measurements are based upon a 40 MHz MCGOUT clock frequency.

⁶ In some specifications, this value is described as, "Long term accuracy of PLL output clock (averaged over 2 ms)" with symbol " $f_{\text{pll_jitter_2ms}}$." The parameter is unchanged, but the description has been changed for clarification purposes.

⁷ In some specifications, this value is described as "Jitter of PLL output clock measured over 625 ns" with symbol " $f_{\text{pll_jitter_625ns}}$." The parameter is unchanged, but the description has been changed for clarification purposes.

⁸ Below D_{lock} minimum, the MCG is guaranteed to enter lock. Above D_{lock} maximum, the MCG will not enter lock. But if the MCG is already in lock, then the MCG may stay in lock.

⁹ Below D_{unl} minimum, the MCG will not exit lock if already in lock. Above D_{unl} maximum, the MCG is guaranteed to exit lock.

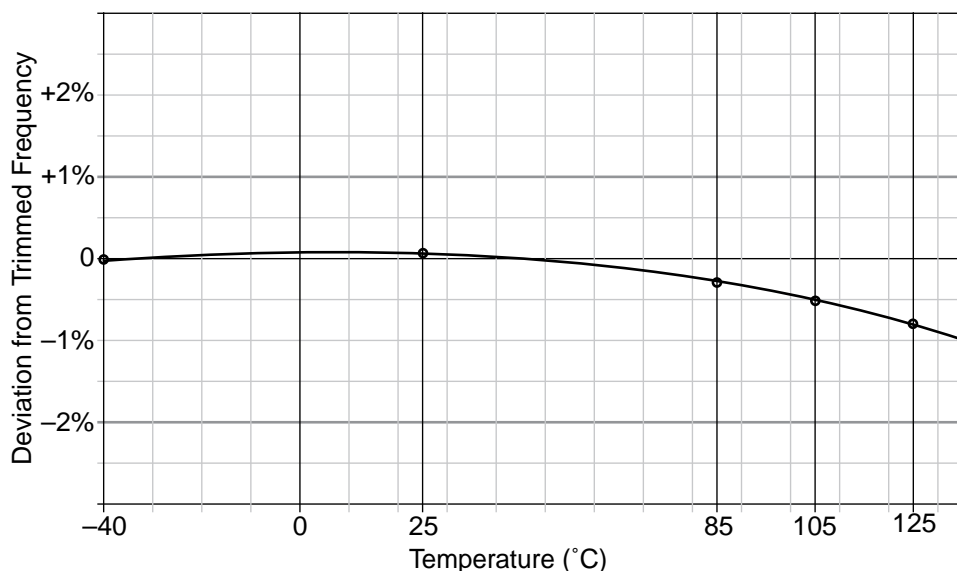
 Figure A-9. Typical Frequency Deviation vs Temperature (ICS Trimmed to 16MHz bus @ 25°C, 5V, FEI)¹

A.12 AC Characteristics

This section describes ac timing characteristics for each peripheral system.

A.12.1 Control Timing

Table A-13. Control Timing

Num	C	Rating	Symbol	Min	Typical ¹	Max	Unit
1	D	Bus frequency ($t_{cyc} = 1/f_{Bus}$)	f_{Bus}	dc	—	20	MHz
2	D	Internal low-power oscillator period	t_{LPO}	800		1500	μs
3	D	External reset pulse width ²	t_{extrst}	100		—	ns
4	D	Reset low drive ³	t_{rstdrv}	$34 \times t_{cyc}$		—	ns
5	D	Active background debug mode latch setup time	t_{MSSU}	500		—	ns
6	D	Active background debug mode latch hold time	t_{MSH}	100		—	ns
7	D	IRQ/PIAx/ PIBx/PIDx/PIJx pulse width Asynchronous path ² Synchronous path ³	t_{ILIH}, t_{IHIL}	100 $1.5 t_{cyc}$	—	—	ns
8	C	Port rise and fall time (load = 50 pF) ⁴ Slew rate control disabled Slew rate control enabled	t_{Rise}, t_{Fall}	— —	3 30		ns

¹ Typical data was characterized at 5.0 V, 25°C unless otherwise stated.

² This is the shortest pulse that is guaranteed to be recognized as a \overline{RESET} pin or pin interrupt request. Shorter pulses are not guaranteed to override reset requests from internal sources.

1. Based on the average of several hundred units from a typical characterization lot.

- 3 When any reset is initiated, internal circuitry drives the $\overline{\text{RESET}}$ pin low for about 34 cycles of f_{sys} . After POR reset, the bus clock frequency changes to the untrimmed DCO frequency ($f_{\text{reset}} = (f_{\text{dco_ut}})/4$) because TRIM is reset to 0x80, FTRIM is reset to 0, and there is an extra divide-by-two because BDIV is reset to 0:1. After other resets, trim stays at the pre-reset value.
- 4 Timing is shown with respect to 20% V_{DD} and 80% V_{DD} levels. Temperature range -40°C to 125°C .

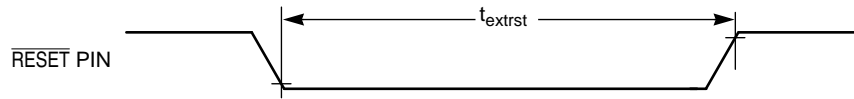

Figure A-10. Reset Timing

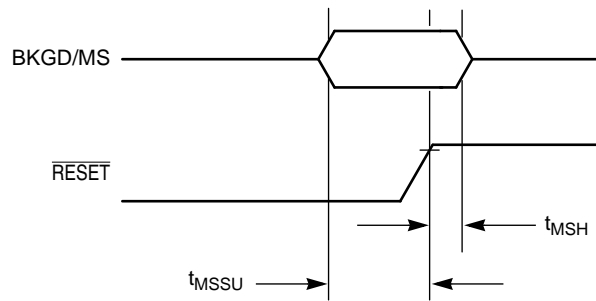

Figure A-11. Active Background Debug Mode Latch Timing

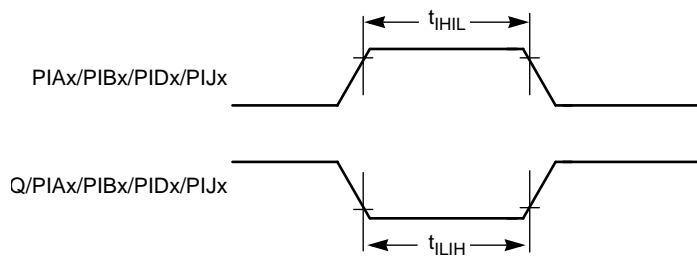

Figure A-12. Pin Interrupt Timing

A.12.2 Timer/PWM

Synchronizer circuits determine the shortest input pulses that can be recognized or the fastest clock that can be used as the optional external source to the timer counter. These synchronizers operate from the current bus rate clock.

Table A-14. TPM Input Timing

Num	C	Rating	Symbol	Min	Max	Unit
1	—	External clock frequency	f_{TPMext}	dc	$f_{BUS}/4$	MHz
2	—	External clock period	t_{TPMext}	4	—	t_{cyc}
3	D	External clock high time	t_{clkh}	1.5	—	t_{cyc}
4	D	External clock low time	t_{clkl}	1.5	—	t_{cyc}
5	D	Input capture pulse width	t_{ICPW}	1.5	—	t_{cyc}

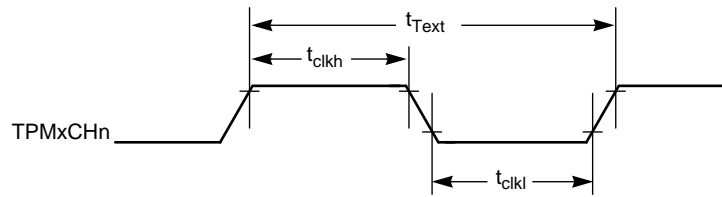

Figure A-13. Timer External Clock

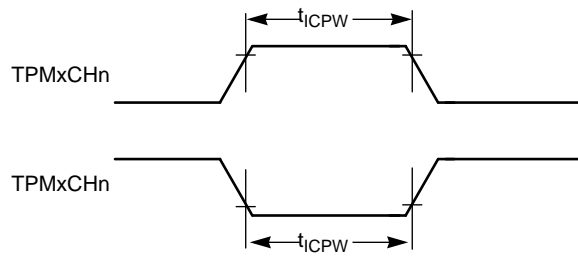

Figure A-14. Timer Input Capture Pulse

A.12.3 MSCAN

Table A-15. MSCAN Wake-up Pulse Characteristics

Num	C	Rating	Symbol	Min	Typ	Max	Unit
1	D	MSCAN Wake-up dominant pulse filtered	t_{WUP}	—	—	2	μs
2	D	MSCAN Wake-up dominant pulse pass	t_{WUP}	5	—	—	μs

A.12.4 SPI

Table A-16 and Figure A-15 through Figure A-18 describe the timing requirements for the SPI system.

Table A-16. SPI Electrical Characteristic

Num ¹	C	Rating ²	Symbol	Min	Max	Unit
1	D	Cycle time Master Slave	t_{SCK} t_{SCK}	2 2.5	2048 —	t_{cyc} t_{cyc}
2	D	Enable lead time Master Slave	t_{Lead} t_{Lead}	— 1/2	1/2 —	t_{SCK} t_{SCK}
3	D	Enable lag time Master Slave	t_{Lag} t_{Lag}	— 1/2	1/2 —	t_{SCK} t_{SCK}
4	D	Clock (SPSCK) high time Master and Slave	t_{SCKH}	$1/2 t_{SCK} - 25$	—	ns
5	D	Clock (SPSCK) low time Master and Slave	t_{SCKL}	$1/2 t_{SCK} - 25$	—	ns
6	D	Data setup time (inputs) Master Slave	$t_{SI(M)}$ $t_{SI(S)}$	30 30	— —	ns ns
7	D	Data hold time (inputs) Master Slave	$t_{HI(M)}$ $t_{HI(S)}$	30 30	— —	ns ns
8	D	Access time, slave ³	t_A	0	40	ns
9	D	Disable time, slave ⁴	t_{dis}	—	40	ns
10	D	Data setup time (outputs) Master Slave	t_{SO} t_{SO}	25 25	— —	ns ns
11	D	Data hold time (outputs) Master Slave	t_{HO} t_{HO}	-10 -10	— —	ns ns
12	D	Operating Frequency ⁵ Master Slave	f_{op} f_{op}	$f_{Bus}/2048$ DC	$f_{Bus}/2$ $f_{Bus}/4$	Hz

¹ Refer to Figure A-15 through Figure A-18.

² All timing is shown with respect to 20% V_{DD} and 70% V_{DD} , unless noted; 100 pF load on all SPI pins. All timing assumes slew rate control disabled and high drive strength enabled for SPI output pins.

³ Time to data active from high-impedance state.

⁴ Hold time to high-impedance state.

⁵ Maximum baud rate must be limited to 5 MHz due to input filter characteristics.

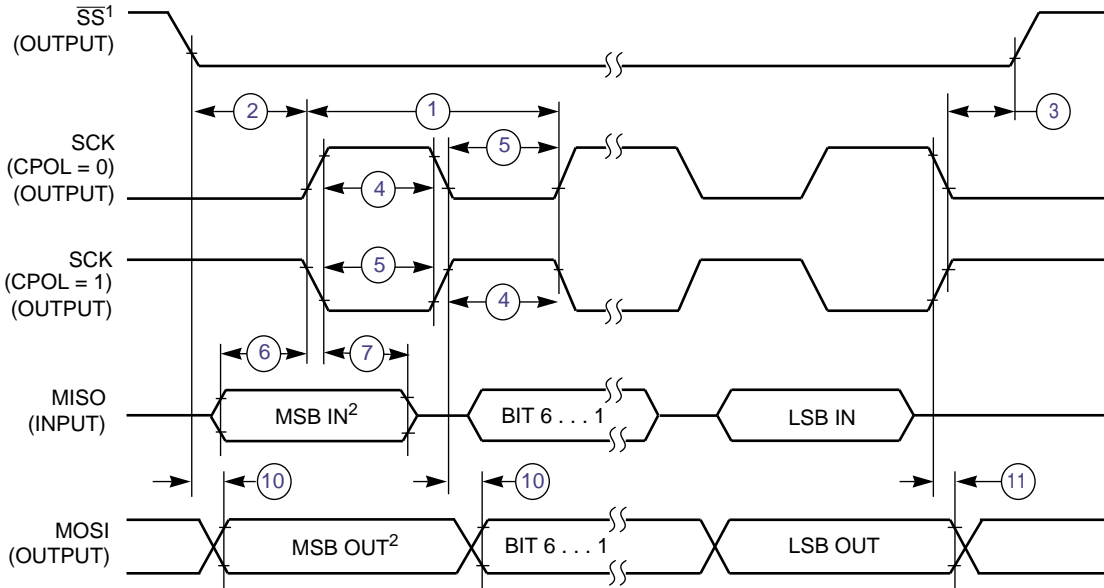

NOTES:

1. \overline{SS} output mode (MODFEN = 1, SSOE = 1).
2. LSBF = 0. For LSBF = 1, bit order is LSB, bit 1, ..., bit 6, MSB.

Figure A-15. SPI Master Timing (CPHA = 0)

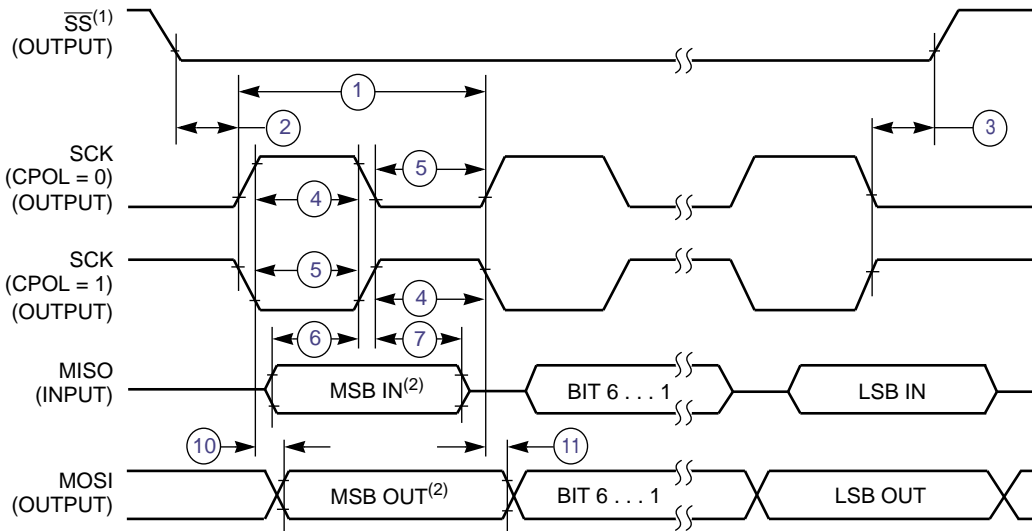

NOTES:

1. \overline{SS} output mode (MODFEN = 1, SSOE = 1).
2. LSBF = 0. For LSBF = 1, bit order is LSB, bit 1, ..., bit 6, MSB.

Figure A-16. SPI Master Timing (CPHA = 1)

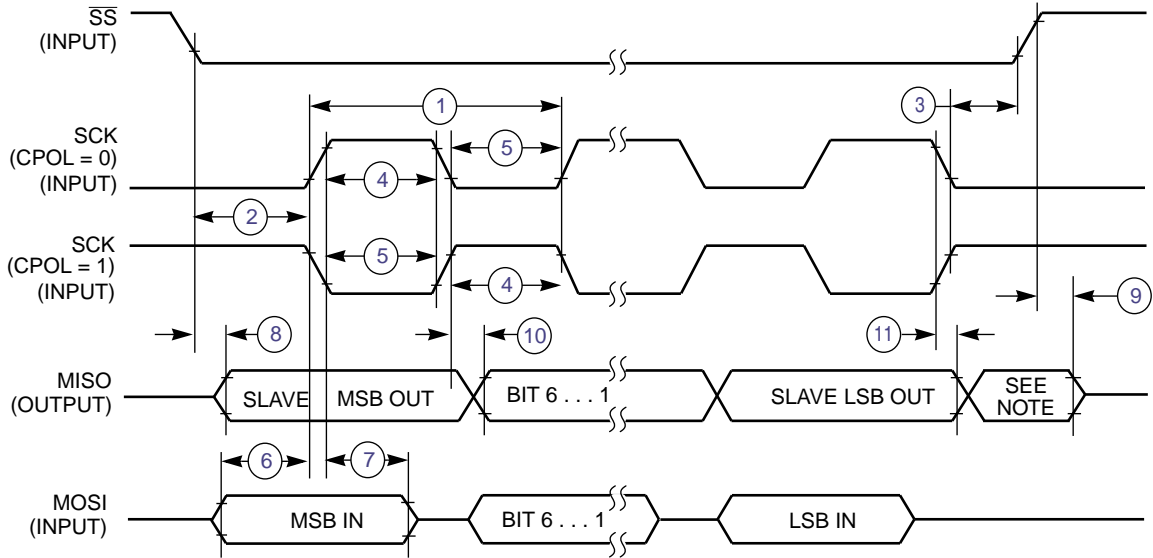

NOTE:

1. Not defined but normally MSB of character just received

Figure A-17. SPI Slave Timing (CPHA = 0)

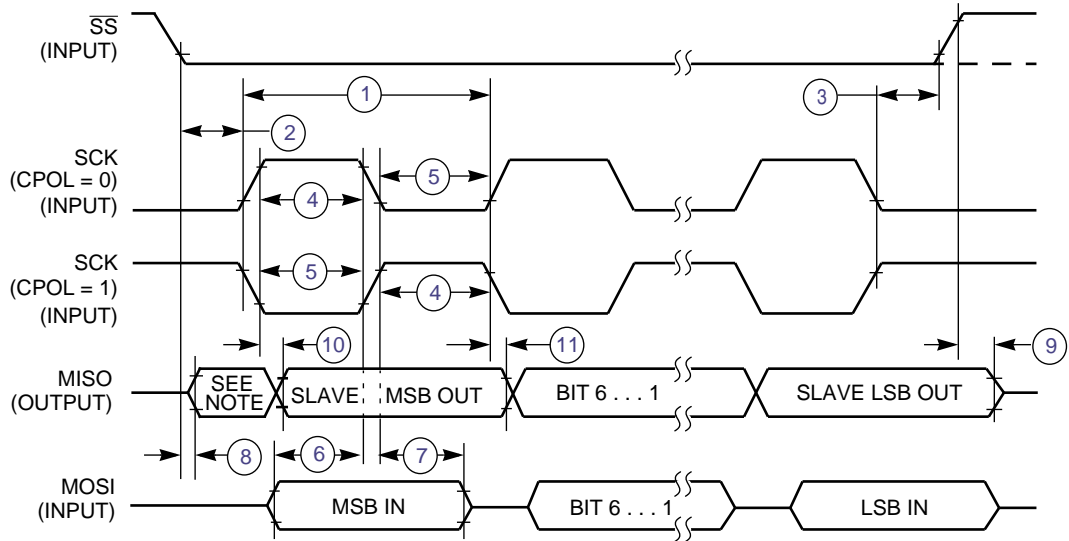

NOTE:

1. Not defined but normally LSB of character just received

Figure A-18. SPI Slave Timing (CPHA = 1)

A.13 FLASH and EEPROM

This section provides details about program/erase times and program-erase endurance for the FLASH and EEPROM memory.

Program and erase operations do not require any special power sources other than the normal V_{DD} supply. For more detailed information about program/erase operations, see [Chapter 4, “Memory.”](#)

NOTE

All values shown in [Table A-17](#) are preliminary and subject to further characterization.

Table A-17. FLASH and EEPROM Characteristics

Num	C	Rating	Symbol	Min	Typical	Max	Unit
1	—	Supply voltage for program/erase	$V_{\text{prog/erase}}$	2.7		5.5	V
2	—	Supply voltage for read operation	V_{Read}	2.7		5.5	V
3	—	Internal FCLK frequency ¹	f_{FCLK}	150		200	kHz
4	—	Internal FCLK period (1/FCLK)	t_{FcyC}	5		6.67	μs
5	—	Byte program time (random location) ⁽²⁾	t_{prog}	9			t_{FcyC}
6	—	Byte program time (burst mode) ⁽²⁾	t_{Burst}	4			t_{FcyC}
7	—	Page erase time ²	t_{Page}	4000			t_{FcyC}
8	—	Mass erase time ⁽²⁾	t_{Mass}	20,000			t_{FcyC}
9	C	FLASH Program/erase endurance ³ T_L to $T_H = -40^\circ\text{C}$ to $+125^\circ\text{C}$ $T = 25^\circ\text{C}$	n_{FLPE}	10,000	100,000	—	cycles
10	C	EEPROM Program/erase endurance ³ T_L to $T_H = -40^\circ\text{C}$ to $+0^\circ\text{C}$ T_L to $T_H = 0^\circ\text{C}$ to $+125^\circ\text{C}$ $T = 25^\circ\text{C}$	n_{EEPE}	10,000 50,000	300,000	—	cycles
11	C	Data retention ⁴	$t_{\text{D_ret}}$	15	100	—	years

¹ The frequency of this clock is controlled by a software setting.

² These values are hardware state machine controlled. User code does not need to count cycles. This information supplied for calculating approximate time to program and erase.

³ **Typical endurance** for FLASH and EEPROM is based on the intrinsic bitcell performance. For additional information on how Freescale Semiconductor defines typical endurance, please refer to Engineering Bulletin EB619, *Typical Endurance for Nonvolatile Memory*.

⁴ **Typical data retention** values are based on intrinsic capability of the technology measured at high temperature and de-rated to 25°C using the Arrhenius equation. For additional information on how Freescale Semiconductor defines typical data retention, please refer to Engineering Bulletin EB618, *Typical Data Retention for Nonvolatile Memory*.

A.14 EMC Performance

Electromagnetic compatibility (EMC) performance is highly dependant on the environment in which the MCU resides. Board design and layout, circuit topology choices, location and characteristics of external components as well as MCU software operation all play a significant role in EMC performance. The system designer should consult Freescale applications notes such as AN2321, AN1050, AN1263, AN2764, and AN1259 for advice and guidance specifically targeted at optimizing EMC performance.

A.14.1 Radiated Emissions

Microcontroller radiated RF emissions are measured from 150 kHz to 1 GHz using the TEM/GTEM Cell method in accordance with the IEC 61967-2 and SAE J1752/3 standards. The measurement is performed with the microcontroller installed on a custom EMC evaluation board while running specialized EMC test software. The radiated emissions from the microcontroller are measured in a TEM cell in two package orientations (North and East). For more detailed information concerning the evaluation results, conditions and setup, please refer to the EMC Evaluation Report for this device.

The maximum radiated RF emissions of the tested configuration in all orientations are less than or equal to the reported emissions levels.

Table A-18. Radiated Emissions

Parameter	Symbol	Conditions	Frequency	f_{osc}/f_{CPU}	Level ¹ (Max)	Unit	
Radiated emissions, electric field	V_{RE_TEM}	$V_{DD} = 5V$ $T_A = +25^{\circ}C$ 100 LQFP	0.15 – 50 MHz	16 MHz Crystal 20 MHz Bus	14	dB μ V	
			50 – 150 MHz		21		
			150 – 500 MHz		6		
			500 – 1000 MHz		-5		
			IEC Level		L		—
			SAE Level		3		—

¹ Data based on qualification test results.

Appendix B

Ordering Information and Mechanical Drawings

B.1 Ordering Information

This section contains ordering information for MC9S08DZ128 Series devices.

Example of the device numbering system:

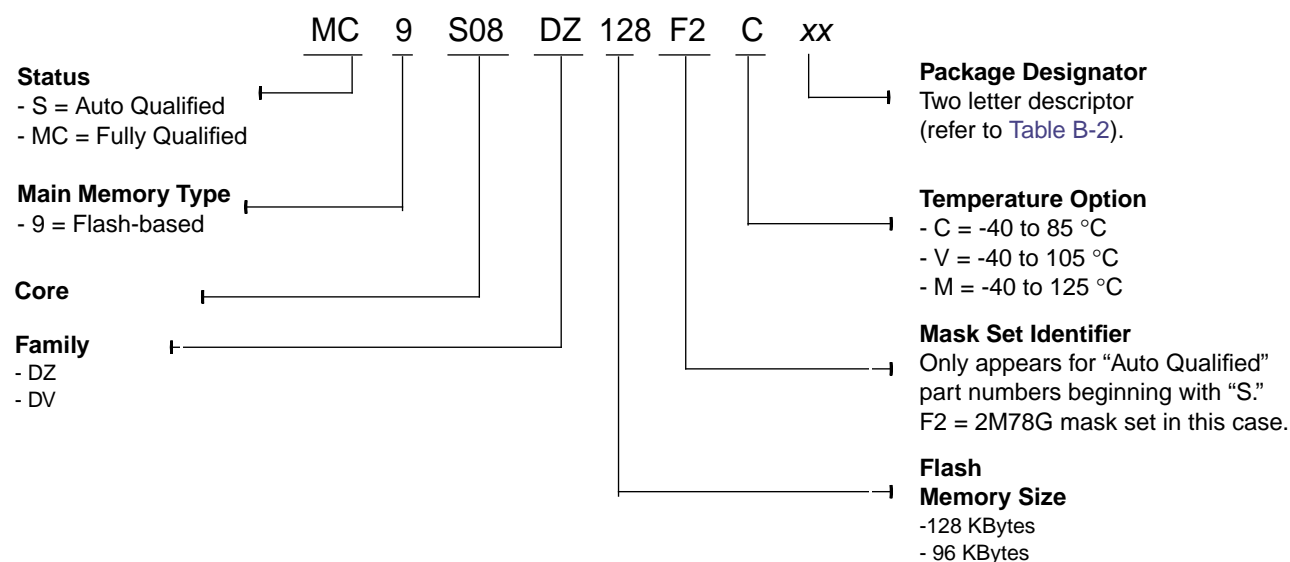

Figure 18-18. Device Numbering Scheme

B.1.1 MC9S08DZ128 Series Devices

Table B-1. Devices in the MC9S08DZ128 Series

Device Number	Memory			Available Packages ¹
	FLASH	RAM	EEPROM	
MC9S08DZ128	128K	8K	2K	100 LQFP 64 LQFP 48 LQFP
MC9S08DZ96	96K	6K	2K	
MC9S08DV128	128K	6K	—	
MC9S08DV96	96K	4K	—	

¹ See Table B-2 for package information.

B.2 Mechanical Drawings

The following pages are mechanical drawings for the packages described in the following table:

Table B-2. Package Descriptions

Pin Count	Type	Abbreviation	Designator	Document No.
100	Low-profile Quad Flat Package	LQFP	LL	98ASS23308W
64	Low-profile Quad Flat Package	LQFP	LH	98ASS23234W
48	Low-profile Quad Flat Package	LQFP	LF	98ASH00962A

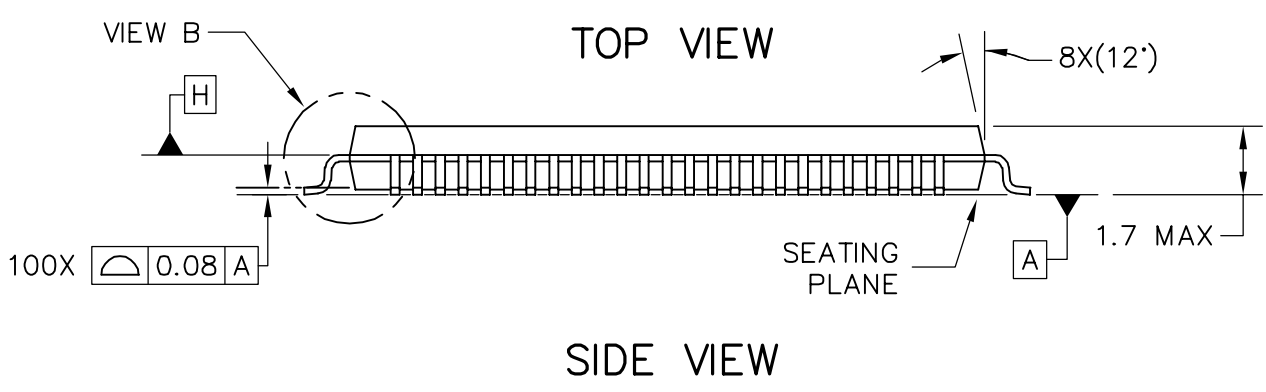
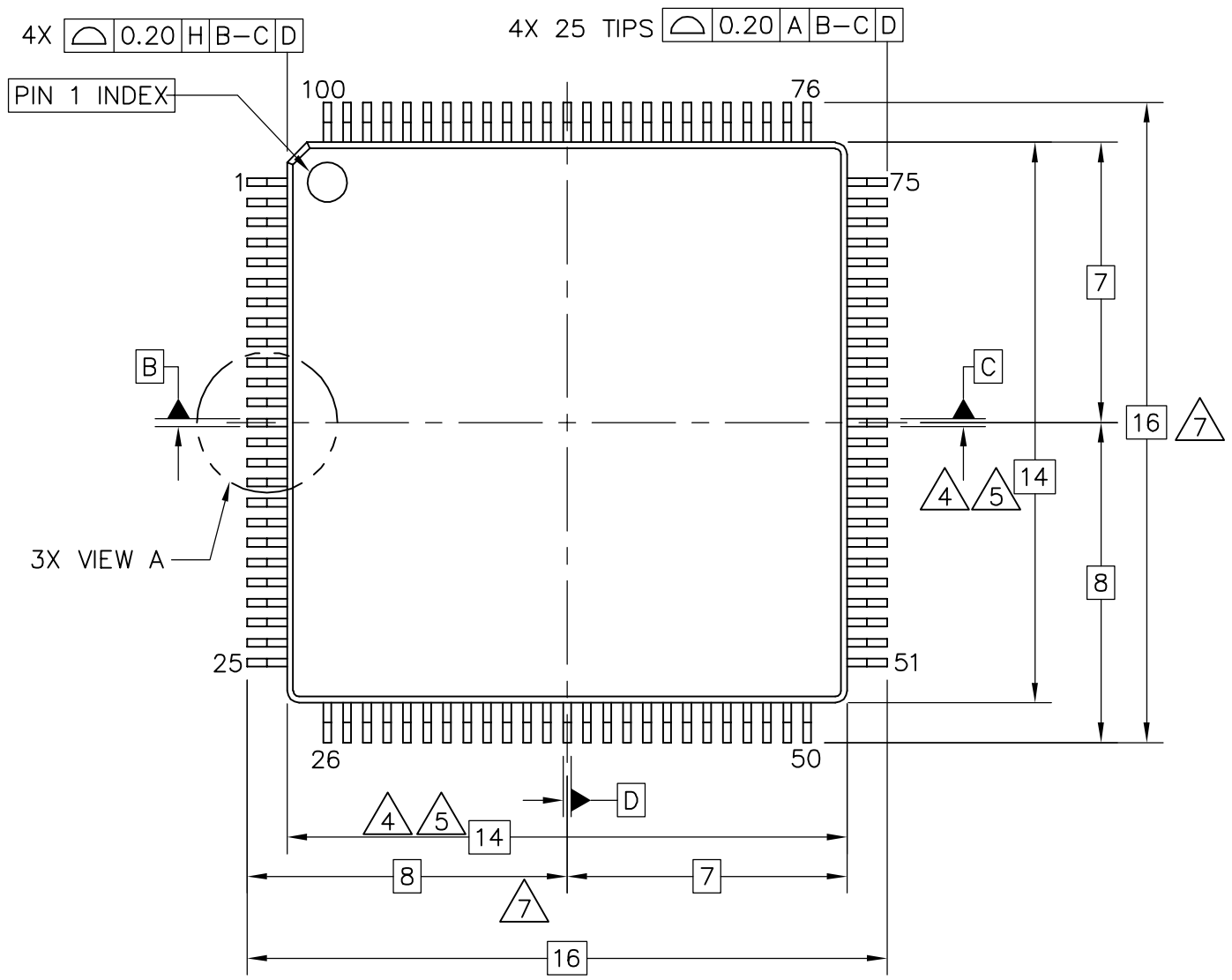

© FREESCALE SEMICONDUCTOR, INC. ALL RIGHTS RESERVED.	MECHANICAL OUTLINE	PRINT VERSION NOT TO SCALE	
TITLE: 100 LEAD LQFP 14 X 14, 0.5 PITCH, 1.4 THICK	DOCUMENT NO: 98ASS23308W	REV: H	
	CASE NUMBER: 983-02	25 MAY 2005	
	STANDARD: NON-JEDEC		

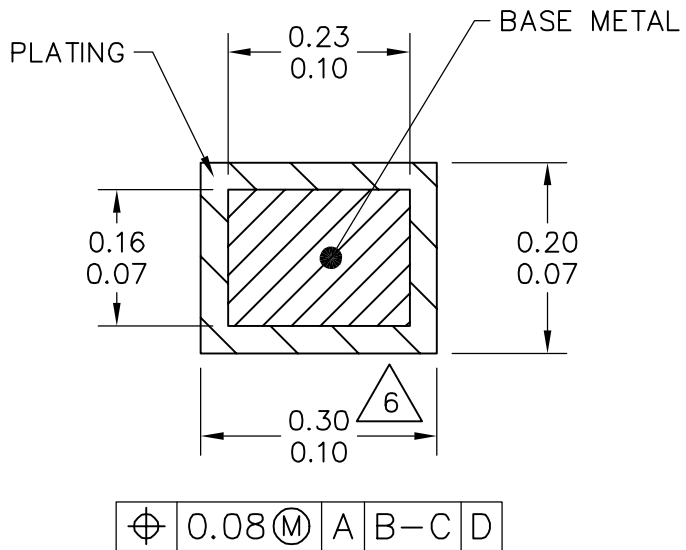
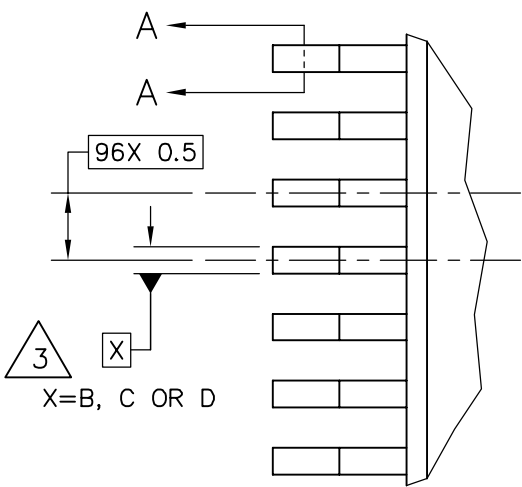

SECTION A-A
ROTATED 90° CW
100 PLACES

VIEW A

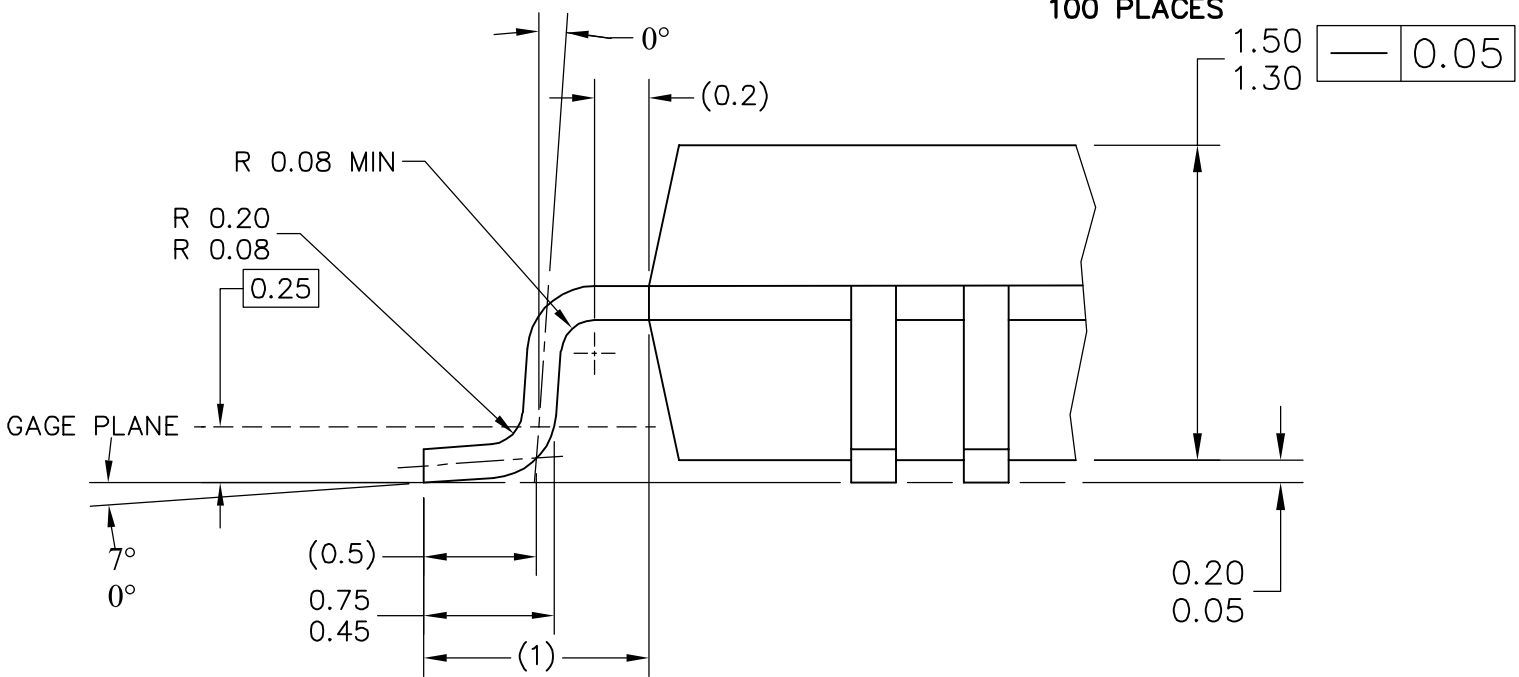

VIEW B

© FREESCALE SEMICONDUCTOR, INC. ALL RIGHTS RESERVED.	MECHANICAL OUTLINE	PRINT VERSION NOT TO SCALE	
TITLE: 100 LEAD LQFP 14 X 14, 0.5 PITCH, 1.4 THICK	DOCUMENT NO: 98ASS23308W	REV: H	
	CASE NUMBER: 983-02	25 MAY 2005	
	STANDARD: NON-JEDEC		



NOTES:

1. ALL DIMENSIONS ARE IN MILLIMETERS.

2. INTERPRET DIMENSIONS AND TOLERANCES PER ASME Y14.5M-1994.

3. DATUMS B, C AND D TO BE DETERMINED AT DATUM PLANE H.

4. THE TOP PACKAGE BODY SIZE MAY BE SMALLER THAN THE BOTTOM PACKAGE SIZE BY A MAXIMUM OF 0.1 mm.

5. DIMENSIONS D1 AND E1 DO NOT INCLUDE MOLD PROTRUSIONS. THE MAXIMUM ALLOWABLE PROTRUSION IS 0.25 mm PER SIDE. D1 AND E1 ARE MAXIMUM BODY SIZE DIMENSIONS INCLUDING MOLD MISMATCH.

6. DIMENSION b DOES NOT INCLUDE DAM BAR PROTRUSION. PROTRUSIONS SHALL NOT CAUSE THE LEAD WIDTH TO EXCEED 0.35. MINIMUM SPACE BETWEEN PROTRUSION AND AN ADJACENT LEAD SHALL BE 0.07 MM.

7. DIMENSIONS D AND E ARE DETERMINED AT THE SEATING PLANE, DATUM A.

© FREESCALE SEMICONDUCTOR, INC. ALL RIGHTS RESERVED.	MECHANICAL OUTLINE	PRINT VERSION NOT TO SCALE	
TITLE: 100 LEAD LQFP 14 X 14, 0.5 PITCH, 1.4 THICK	DOCUMENT NO: 98ASS23308W		REV: H
	CASE NUMBER: 983-02		25 MAY 2005
	STANDARD: NON-JEDEC		

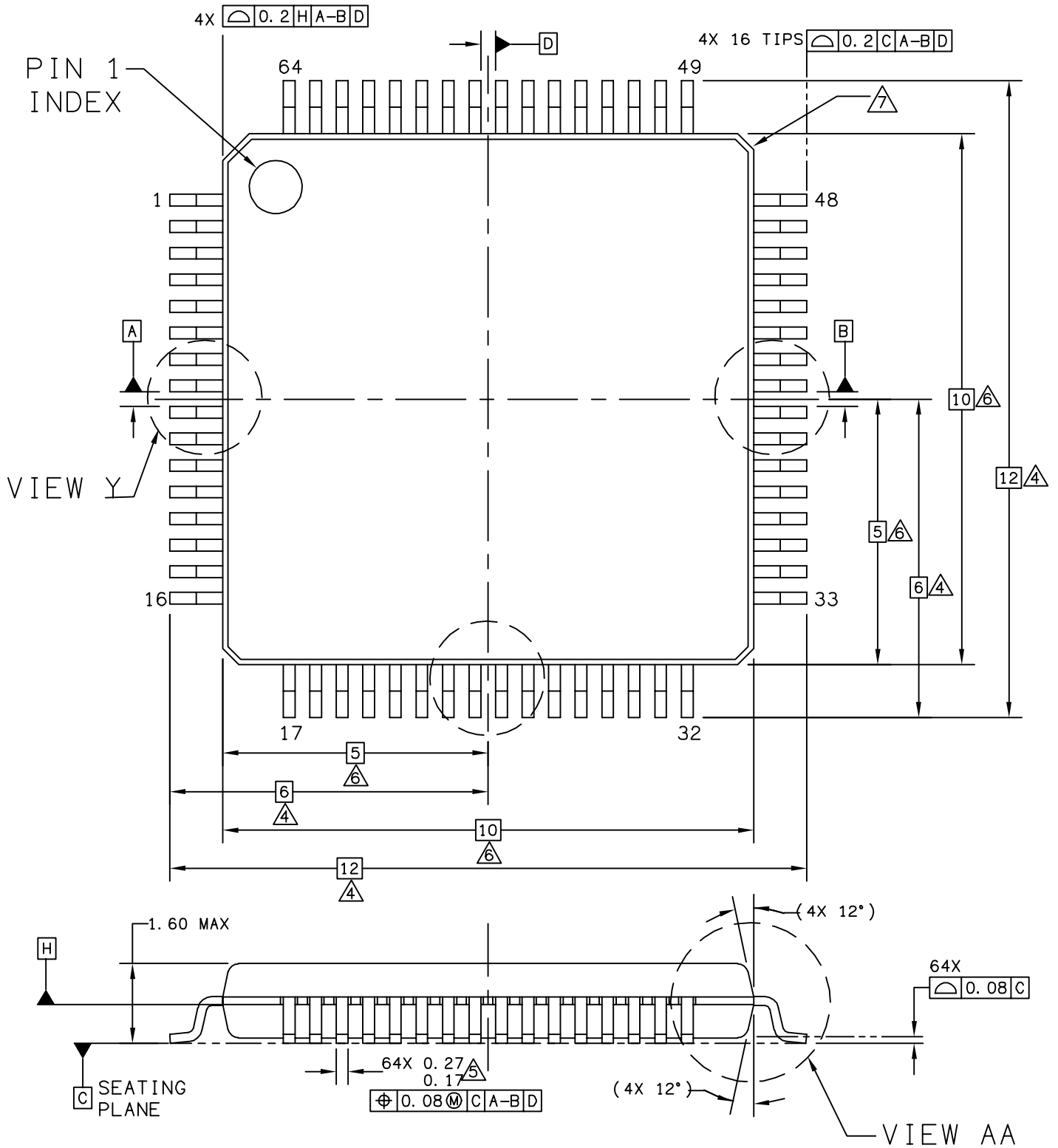

© FREESCALE SEMICONDUCTOR, INC. ALL RIGHTS RESERVED.	MECHANICAL OUTLINE	PRINT VERSION NOT TO SCALE	
TITLE: 64LD LQFP, 10 X 10 X 1.4 PKG, 0.5 PITCH, CASE OUTLINE	DOCUMENT NO: 98ASS23234W	REV: E	
	CASE NUMBER: 840F-02	11 AUG 2006	
	STANDARD: JEDEC MS-026 BCD		

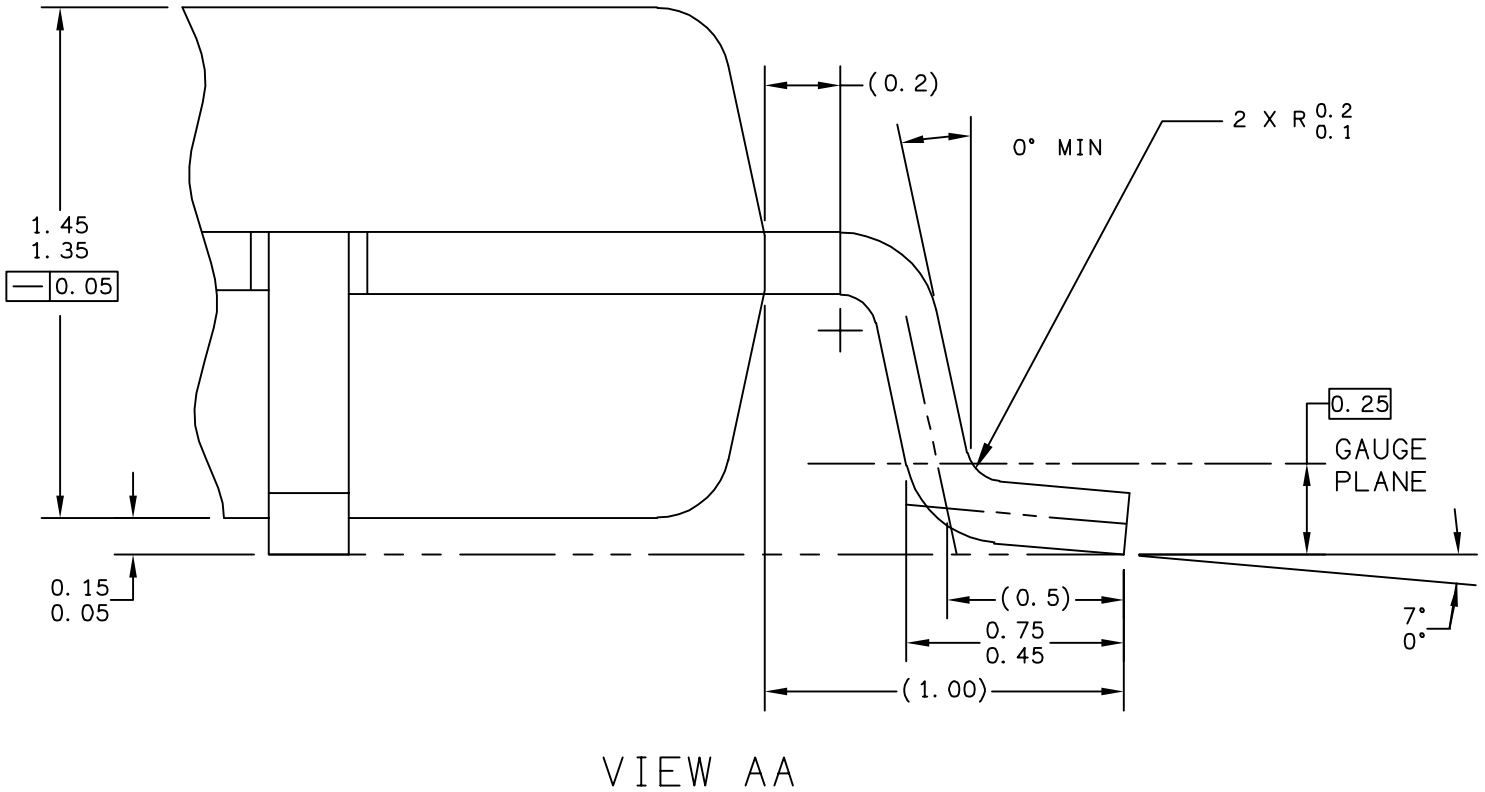
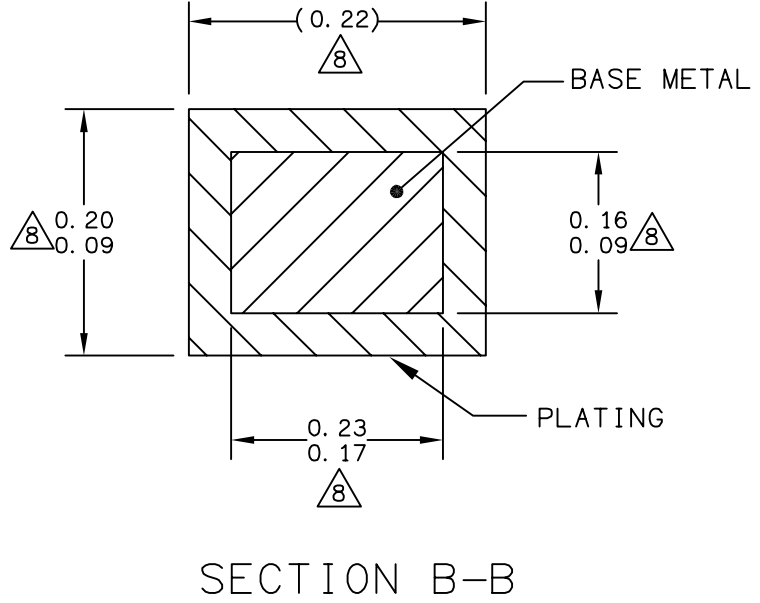
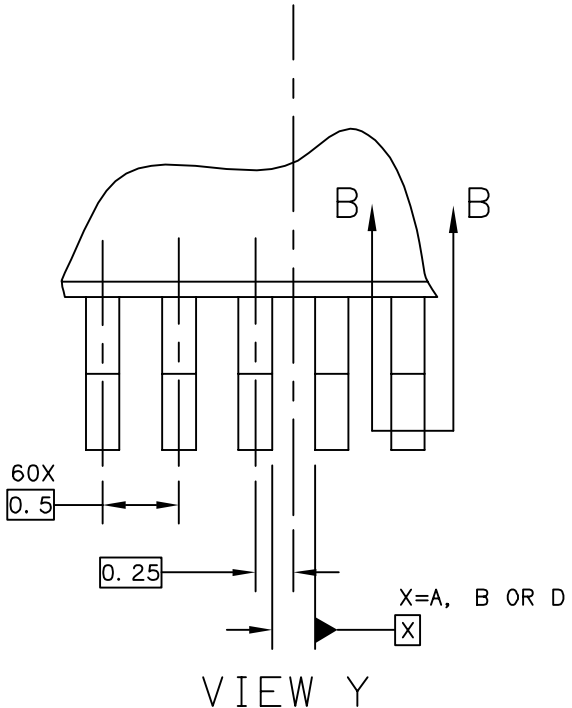

© FREESCALE SEMICONDUCTOR, INC. ALL RIGHTS RESERVED.	MECHANICAL OUTLINE	PRINT VERSION NOT TO SCALE	
TITLE: 64LD LQFP, 10 X 10 X 1.4 PKG, 0.5 PITCH, CASE OUTLINE	DOCUMENT NO: 98ASS23234W	REV: E	
	CASE NUMBER: 840F-02	11 AUG 2006	
	STANDARD: JEDEC MS-026 BCD		



NOTES:

- 1. DIMENSIONS ARE IN MILLIMETERS.
- 2. DIMENSIONING AND TOLERANCING PER ASME Y14.5M-1994.
- 3. DATUMS A, B AND D TO BE DETERMINED AT DATUM PLANE H.

△4. DIMENSIONS TO BE DETERMINED AT SEATING PLANE C.

△5. THIS DIMENSION DOES NOT INCLUDE DAMBAR PROTRUSION. ALLOWABLE DAMBAR PROTRUSION SHALL NOT CAUSE THE LEAD WIDTH TO EXCEED THE UPPER LIMIT BY MORE THAN 0.08 mm AT MAXIMUM MATERIAL CONDITION. DAMBAR CANNOT BE LOCATED ON THE LOWER RADIUS OR THE FOOT. MINIMUM SPACE BETWEEN PROTRUSION AND ADJACENT LEAD SHALL NOT BE LESS THAN 0.07 mm.

△6. THIS DIMENSION DOES NOT INCLUDE MOLD PROTRUSION. ALLOWABLE PROTRUSION IS 0.25 mm PER SIDE. THIS DIMENSION IS MAXIMUM PLASTIC BODY SIZE DIMENSION INCLUDING MOLD MISMATCH.

△7. EXACT SHAPE OF EACH CORNER IS OPTIONAL.

△8. THESE DIMENSIONS APPLY TO THE FLAT SECTION OF THE LEAD BETWEEN 0.1 mm AND 0.25 mm FROM THE LEAD TIP.

© FREESCALE SEMICONDUCTOR, INC. ALL RIGHTS RESERVED.	MECHANICAL OUTLINE	PRINT VERSION NOT TO SCALE	
TITLE: 64LD LQFP, 10 X 10 X 1.4 PKG, 0.5 PITCH, CASE OUTLINE	DOCUMENT NO: 98ASS23234W	REV: E	
	CASE NUMBER: 840F-02	11 AUG 2006	
	STANDARD: JEDEC MS-026 BCD		

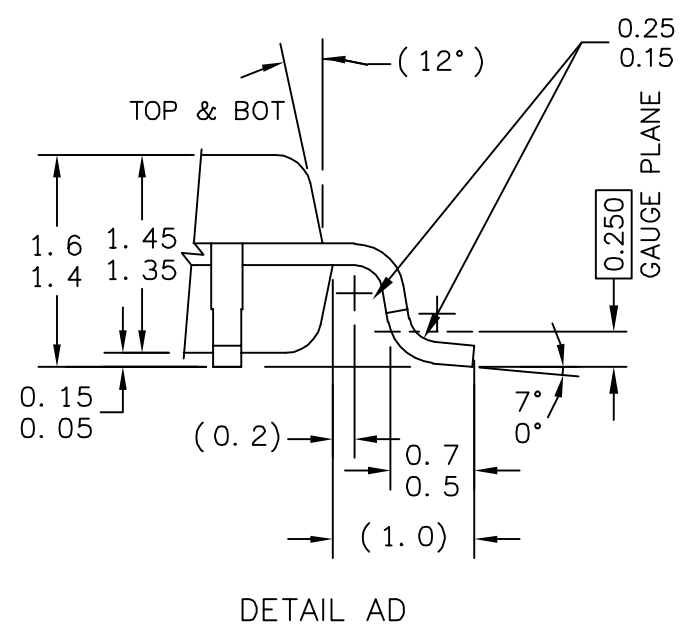
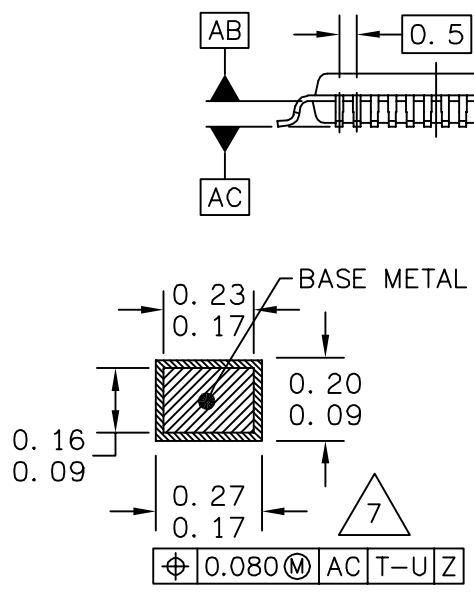
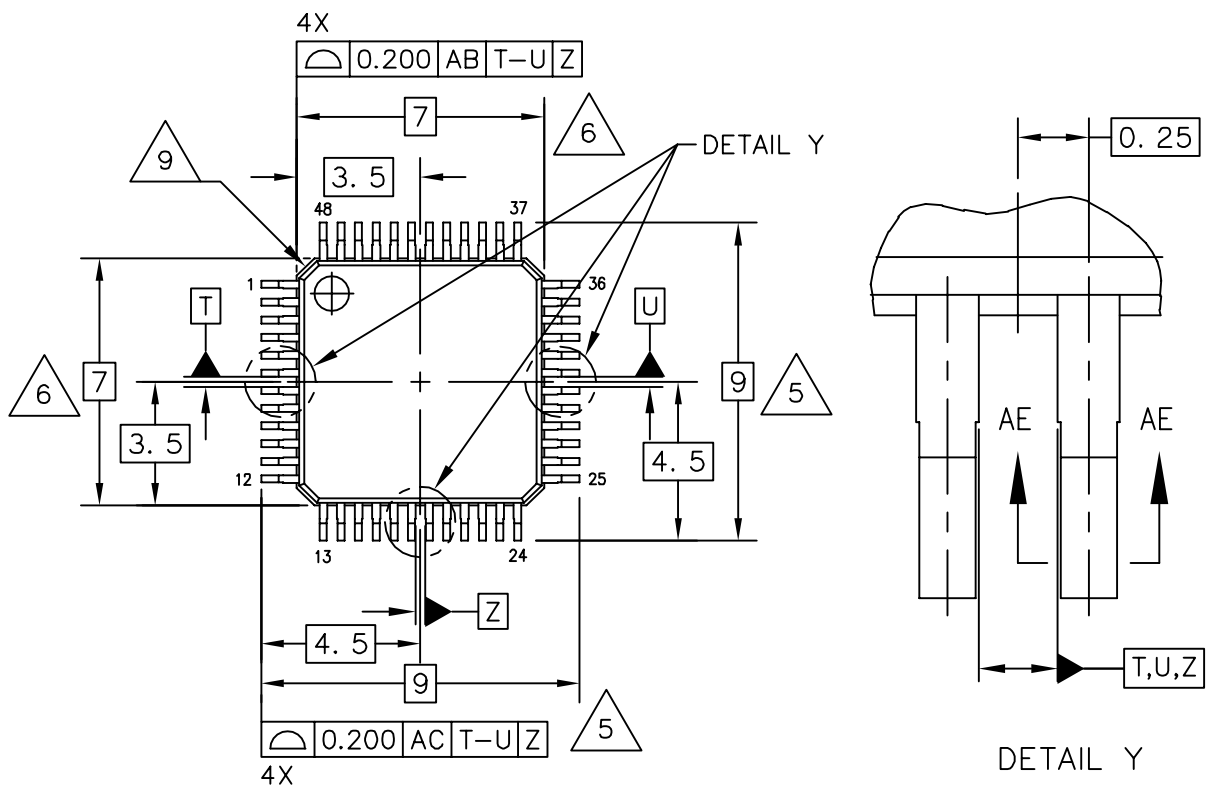

SECTION AE-AE

DETAIL AD

© FREESCALE SEMICONDUCTOR, INC. ALL RIGHTS RESERVED.	MECHANICAL OUTLINE	PRINT VERSION NOT TO SCALE	
TITLE: LQFP, 48 LEAD, 0.50 PITCH (7.0 X 7.0 X 1.4)	DOCUMENT NO: 98ASH00962A	REV: G	
	CASE NUMBER: 932-03	14 APR 2005	
	STANDARD: JEDEC MS-026-BBC		



NOTES:

1. DIMENSIONS AND TOLERANCING PER ASME Y14.5M-1994.
2. CONTROLLING DIMENSION: MILLIMETER.
3. DATUM PLANE AB IS LOCATED AT BOTTOM OF LEAD AND IS COINCIDENT WITH THE LEAD WHERE THE LEAD EXITS THE PLASTIC BODY AT THE BOTTOM OF THE PARTING LINE.
4. DATUMS T, U, AND Z TO BE DETERMINED AT DATUM PLANE AB.

5. DIMENSIONS TO BE DETERMINED AT SEATING PLANE AC.

6. DIMENSIONS DO NOT INCLUDE MOLD PROTRUSION. ALLOWABLE PROTRUSION IS 0.250 PER SIDE. DIMENSIONS DO INCLUDE MOLD MISMATCH AND ARE DETERMINED AT DATUM PLANE AB.

7. THIS DIMENSION DOES NOT INCLUDE DAMBAR PROTRUSION. DAMBAR PROTRUSION SHALL NOT CAUSE THE LEAD WIDTH TO EXCEED 0.350.

8. MINIMUM SOLDER PLATE THICKNESS SHALL BE 0.0076.

9. EXACT SHAPE OF EACH CORNER IS OPTIONAL.

© FREESCALE SEMICONDUCTOR, INC. ALL RIGHTS RESERVED.	MECHANICAL OUTLINE	PRINT VERSION NOT TO SCALE	
TITLE: LQFP, 48 LEAD, 0.50 PITCH (7.0 X 7.0 X 1.4)	DOCUMENT NO: 98ASH00962A	REV: G	
	CASE NUMBER: 932-03	14 APR 2005	
	STANDARD: JEDEC MS-026-BBC		

How to Reach Us:

Home Page:

www.freescale.com

E-mail:

support@freescale.com

USA/Europe or Locations Not Listed:

Freescale Semiconductor
Technical Information Center, CH370
1300 N. Alma School Road
Chandler, Arizona 85224
+1-800-521-6274 or +1-480-768-2130
support@freescale.com

Europe, Middle East, and Africa:

Freescale Halbleiter Deutschland GmbH
Technical Information Center
Schatzbogen 7
81829 Muenchen, Germany
+44 1296 380 456 (English)
+46 8 52200080 (English)
+49 89 92103 559 (German)
+33 1 69 35 48 48 (French)
support@freescale.com

Japan:

Freescale Semiconductor Japan Ltd.
Headquarters
ARCO Tower 15F
1-8-1, Shimo-Meguro, Meguro-ku,
Tokyo 153-0064
Japan
0120 191014 or +81 3 5437 9125
support.japan@freescale.com

Asia/Pacific:

Freescale Semiconductor Hong Kong Ltd.
Technical Information Center
2 Dai King Street
Tai Po Industrial Estate
Tai Po, N.T., Hong Kong
+800 2666 8080
support.asia@freescale.com

For Literature Requests Only:

Freescale Semiconductor Literature Distribution Center
P.O. Box 5405
Denver, Colorado 80217
1-800-441-2447 or 303-675-2140
Fax: 303-675-2150
LDCForFreescaleSemiconductor@hibbertgroup.com

Information in this document is provided solely to enable system and software implementers to use Freescale Semiconductor products. There are no express or implied copyright licenses granted hereunder to design or fabricate any integrated circuits or integrated circuits based on the information in this document.

Freescale Semiconductor reserves the right to make changes without further notice to any products herein. Freescale Semiconductor makes no warranty, representation or guarantee regarding the suitability of its products for any particular purpose, nor does Freescale Semiconductor assume any liability arising out of the application or use of any product or circuit, and specifically disclaims any and all liability, including without limitation consequential or incidental damages. "Typical" parameters that may be provided in Freescale Semiconductor data sheets and/or specifications can and do vary in different applications and actual performance may vary over time. All operating parameters, including "Typicals", must be validated for each customer application by customer's technical experts. Freescale Semiconductor does not convey any license under its patent rights nor the rights of others. Freescale Semiconductor products are not designed, intended, or authorized for use as components in systems intended for surgical implant into the body, or other applications intended to support or sustain life, or for any other application in which the failure of the Freescale Semiconductor product could create a situation where personal injury or death may occur. Should Buyer purchase or use Freescale Semiconductor products for any such unintended or unauthorized application, Buyer shall indemnify and hold Freescale Semiconductor and its officers, employees, subsidiaries, affiliates, and distributors harmless against all claims, costs, damages, and expenses, and reasonable attorney fees arising out of, directly or indirectly, any claim of personal injury or death associated with such unintended or unauthorized use, even if such claim alleges that Freescale Semiconductor was negligent regarding the design or manufacture of the part.

Freescale™ and the Freescale logo are trademarks of Freescale Semiconductor, Inc. All other product or service names are the property of their respective owners.

© Freescale Semiconductor, Inc. 2007, 2008. All rights reserved.

Mouser Electronics

Authorized Distributor

Click to View Pricing, Inventory, Delivery & Lifecycle Information:

NXP:

[S9S08DV128F2MLF](#) [S9S08DV128F2MLH](#) [S9S08DV128F2MLL](#) [S9S08DZ16F1CLC](#) [S9S08DZ16F1MLF](#)
[S9S08DZ16F1MLC](#) [S9S08DZ48F1MLF](#) [MC9S08DV128CLF](#) [MC9S08DV128MLF](#) [MC9S08DV96CLF](#)
[MC9S08DZ128CLF](#) [MC9S08DZ128CLH](#) [MC9S08DZ128CLL](#) [MC9S08DZ128MLF](#) [MC9S08DZ128MLH](#)
[MC9S08DZ128MLL](#) [MC9S08DZ96CLF](#) [MC9S08DZ96CLH](#) [MC9S08DZ96CLL](#) [MC9S08DZ96MLF](#) [MC9S08DZ96MLH](#)
[MC9S08DZ96MLL](#) [S9S08DZ128F2CLH](#) [S9S08DZ128F2MLF](#) [S9S08DZ128F2MLH](#) [S9S08DZ128F2MLL](#)
[S9S08DZ128F2VLL](#) [S9S08DZ32F1CLH](#) [S9S08DZ32F1MLC](#) [S9S08DZ32F1MLF](#) [S9S08DZ32F1MLH](#)
[S9S08DZ60F1CLC](#) [S9S08DZ60F1CLF](#) [S9S08DZ60F1CLH](#) [S9S08DZ60F1MLC](#) [S9S08DZ60F1MLF](#)
[S9S08DZ60F1MLH](#) [S9S08DZ60F1VLH](#) [S9S08DZ96F2CLH](#) [S9S08DZ96F2MLF](#) [S9S08DZ96F2MLH](#)
[S9S08DZ96F2MLL](#) [S9S08DZ96F2VLL](#) [S9S08DZ48F1CLH](#) [S9S08DZ16F2MLC](#) [S9S08DZ96F2VLH](#)
[MC9S08DV128MLH](#) [MC9S08DV128CLH](#) [MC9S08DV128MLL](#) [MC9S08DV128CLL](#) [S9S08DZ16F2VLF](#)
[S9S08DZ96F2VLF](#) [S9S08DV96F2CLF](#) [S9S08DZ128F2CLF](#) [MC9S08DZ128CLLR](#) [S9S08DV128F2CLFR](#)
[S9S08DV96F2CLFR](#) [S9S08DZ128F2MLLR](#) [S9S08DZ128F2MLHR](#) [S9S08DV128F2CLF](#) [S9S08DZ60F2CLCR](#)