

200W isolated DC-DC converter
Wide input and regulated single output

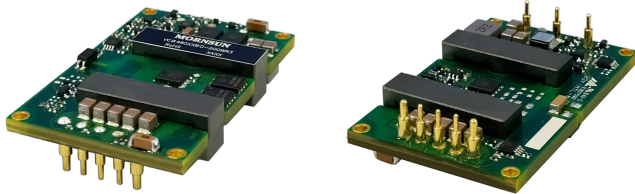

FEATURES

- Wide 2:1 input voltage range
- High efficiency up to 93%
- I/O isolation test voltage 1.5k VDC
- Operating ambient temperature range: -40°C to +100°C
- Input under-voltage protection, output short circuit, over-current, over-voltage, over-temperature protection
- Industry standard package: 1/4 brick
- Meet IEC/UL/EN62368 standards



Patent Protection RoHS



UL62368-1 EN62368-1 BS EN62368-1

VCB48_QBO-200WR3(-N) series of isolated 200W DC-DC converter products with a wide 2:1 input voltage range. They feature efficiencies of up to 93%, input to output isolation is tested with 1500VDC and the converters safely operate ambient temperature of -40°C to +100°C, input under-voltage protection, output short circuit, over-current, over-voltage, over-temperature protection. They are ideally and widely used in applications such as industrial control, electric power, instruments and communication fields.

Selection Guide

Certification	Part No.	Input Voltage (VDC)		Output		Full Load Efficiency ^② (%) Min./Typ.	Max. Capacitive Load(μF)
		Nominal (Range)	Max. ^①	Voltage (VDC)	Current (A) Max./Min.		
EN/BS EN	VCB4805QBO-200WR3	48 (36-75)	75	5	36.00/0	89/91	6000
	VCB4812QBO-200WR3			12	16.67/0	91/93	2000
	VCB4815QBO-200WR3			15	13.33/0	91/93	2000
	VCB4824QBO-200WR3			24	8.33/0	90/92	1000
UL/EN/BS EN	VCB4805QBO-200WR3-N	48 (36-75)	75	5	36.00/0	89/91	6000
	VCB4812QBO-200WR3-N			12	16.67/0	91/93	2000
	VCB4815QBO-200WR3-N			15	13.33/0	91/93	2000
	VCB4824QBO-200WR3-N			24	8.33/0	90/92	1000

Notes:

- ① Exceeding the maximum input voltage may cause permanent damage;
② Efficiency is measured in nominal input voltage and rated output load;
③ "N" means negative logic.

Input Specifications

Item	Operating Conditions	Min.	Typ.	Max.	Unit
Input Current (full load / no-load)	Nominal input voltage	--	4579/20	4682/35	mA
Reflected Ripple Current		--	30	120	
Surge Voltage (1sec. max.)		-0.7	--	80	VDC
Start-up Voltage		--	--	36	VDC
Start-up Current		--	--	8.8	A
Input Under-voltage Protection		26	29	--	VDC
Start-up Time	Nominal input voltage & constant resistance load	--	--	100	ms
Input Filter		Pi filter			
Hot Plug		Unavailable			
Ctrl ^①	Module on	VCB48_QBO-200WR3	Ctrl pin open or pulled high (TTL 3.5-12VDC)		
		VCB48_QBO-200WR3-N	Ctrl pin pulled low to GND (0-1.2VDC)		
	Module off	VCB48_QBO-200WR3	Ctrl pin pulled low to GND (0-1.2VDC)		
		VCB48_QBO-200WR3-N	Ctrl pin open or pulled high (TTL 3.5-12VDC)		

	Input current when off	--	3	10	mA
--	------------------------	----	---	----	----

Note: ①The Ctrl pin voltage is referenced to input -Vin.

Output Specifications

Item	Operating Conditions	Min.	Typ.	Max.	Unit
Voltage Accuracy	0%-100% load	--	±1	±3	%Vo
Linear Regulation	Input voltage variation from low to high at full load	--	±0.2	±0.5	
Load Regulation	5%-100% load	--	±0.5	±0.75	
Transient Recovery Time	25% load step change	--	200	500	μs
Transient Response Deviation	25% load step change	5V output	±3	±8	%Vo
		Others	±3	±7	
Temperature Coefficient	Full load	--	--	±0.03	%/°C
Ripple & Noise ^①	20MHz bandwidth, nominal input voltage, 5%-100% load	--	100	150	mV p-p
Trim		90	--	110	%Vo
Sense		--	--	105	
Over Temperature	Product surface max. temperature	--	130	--	°C
Over-voltage Protection	Input voltage range	110	125	160	%Vo
Over-current Protection		110	140	190	%Io
Short-circuit Protection		Continuous, self-recovery, time ≤ 3 seconds			

Note: ①The "Tip and barrel" method is used for ripple and noise test, please refer to *DC-DC Converter Application Notes* for specific information. Ripple & Noise at <5% load is 5%Vo max.

General Specifications

Item	Operating Conditions	Min.	Typ.	Max.	Unit
Isolation	Input-output Electric Strength test for 1 minute with a leakage current of 1mA max.	1500	--	--	VDC
Insulation Resistance	Input-output resistance at 500VDC	1000	--	--	MΩ
Isolation Capacitance	Input-output capacitance at 100KHz/0.1V	--	1000	--	pF
Operating Temperature	See typical characteristic curves	-40	--	+100	°C
Storage Temperature		-55	--	+125	
Storage Humidity	Non-condensing	5	--	95	%RH
Pin Soldering Resistance Temperature	Wave soldering, 10 seconds	--	--	+260	°C
	Soldering spot is 1.5mm away from case for 10 seconds	--	--	+300	
Shock and Vibration Test		10-150Hz, 10G, 30Min. along X, Y and Z			
Switching Frequency ^①	PWM Mode	--	200	--	KHz
Altitude		Altitude: ≤2000m, Atmospheric pressure: 80~110KPa			
MTBF	MIL-HDBK-217F@25°C	500	--	--	K hours

Note: ①Switching frequency is measured at full load. The module reduces the switching frequency for light load (below 50%) efficiency improvement.

Mechanical Specifications

Dimensions	57.9 x 36.80 x 10.05mm
Weight	43.6g(Typ.)
Cooling Method	Natural convection or forced air convection

Electromagnetic Compatibility (EMC)

Emissions	CE	CISPR32/EN55032 CLASS A (see Fig.3 for recommended circuit)/CLASS B (see Fig.4 for recommended circuit)
	RE	CISPR32/EN55032 CLASS A (see Fig.3 for recommended circuit)/CLASS B (see Fig.4 for recommended circuit)
Immunity	ESD	IEC/EN61000-4-2 Contact ±6KV perf. Criteria B
	RS	IEC/EN61000-4-3 10V/m perf. Criteria A

EFT	IEC/EN61000-4-4	±2KV (see Fig.3 for recommended circuit)	perf. Criteria B
Surge	IEC/EN61000-4-5	line to line ±2KV(see Fig.3 for recommended circuit)	perf. Criteria B
CS	IEC/EN61000-4-6	3 Vr.m.s	perf. Criteria A

Typical Characteristic Curves

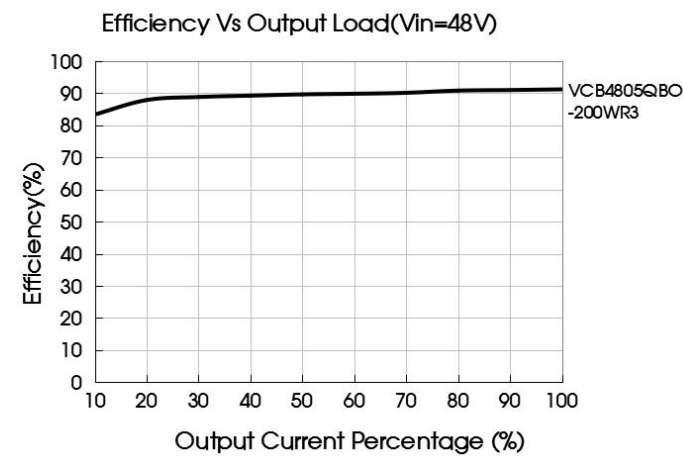
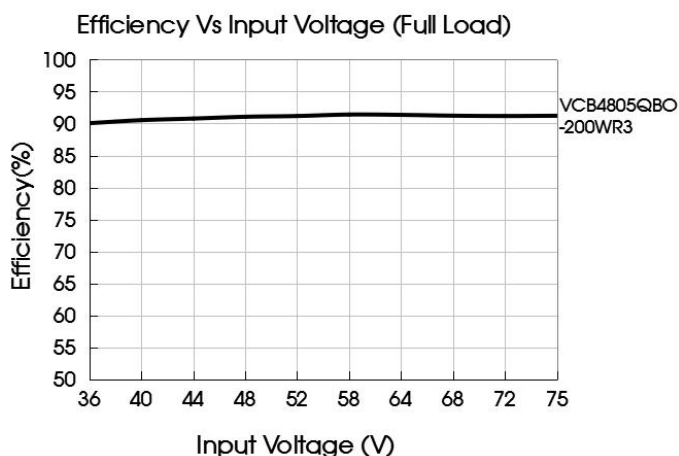
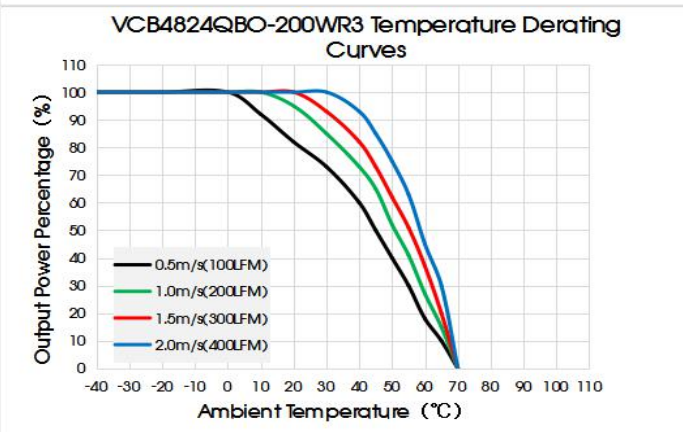
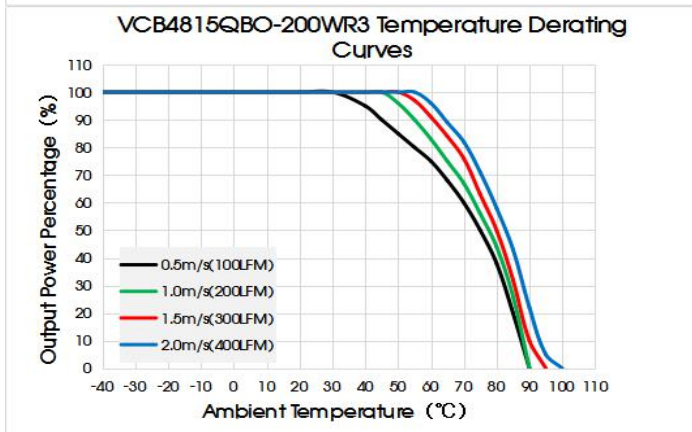
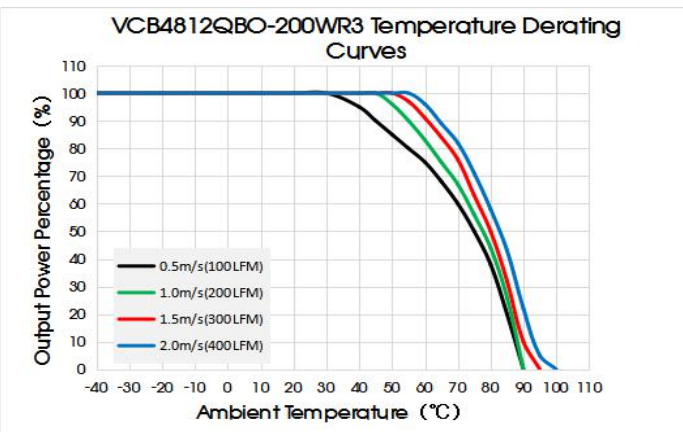
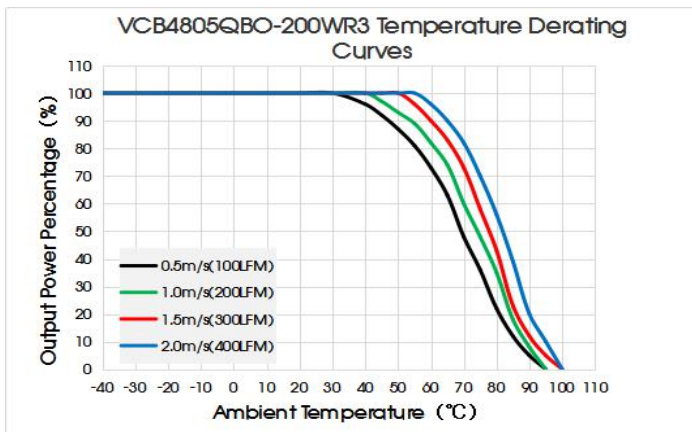

Remote Sense Application

1. Remote Sense Connection if not used

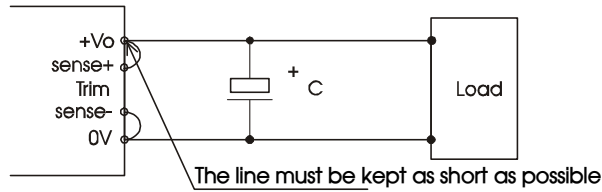

Notes:

- (1) If the sense function is not used for remote regulation the user must connect the +Sense to + Vo and -Sense to 0V at the DC-DC converter pins and will compensate for voltage drop across pins only.
- (2) The connections between Sense lines and their respective power lines must be kept as short as possible, otherwise they may be picking up noise, interference and/or causing unstable operation of the power module.

2. Remote Sense Connection used for Compensation

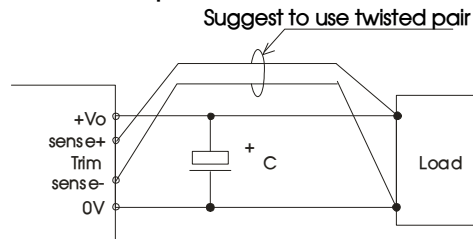

Notes:

- (1) Using remote sense with long wires may cause unstable output, please contact technical support if long wires must be used.
- (2) PCB-tracks or cables/wires for Remote Sense must be kept as short as possible. Twisted pair or shielded wires are suggested for remote compensation and must be kept as short as possible.
- (3) We recommend using adequate cross section for PCB-track layout and/or cables to connect the power supply module to the load in order to keep the voltage drop below 0.3V and to make sure the power supply's output voltage remains within the specified range.
- (4) Note that large wire impedance may cause oscillation of the output voltage and/or increased ripple. Consult technical support or factory for further advice of sense operation.

Design Reference

1. Ripple&Noise

All the DC-DC converters of this series are tested before delivery using the recommended circuit shown in Fig. 1.

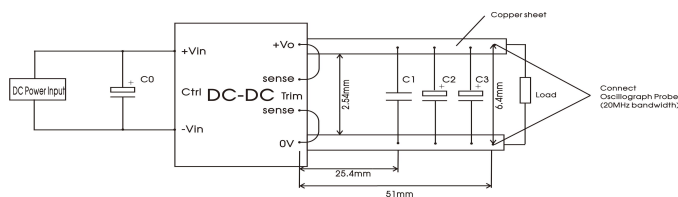

Fig. 1

Capacitors Value	C0	C1	C2	C3
Output Voltage				
5VDC	100uF/ 100V	1uF/50V	10uF/50V	220uF/63V
12VDC				
15VDC				
24VDC				

2. Typical application

We recommended using Mornsun's EMC circuit, otherwise please ensure that at least a 100µF electrolytic capacitors is connected at the input in order to ensure adequate voltage surge suppression and protection.

Input and/or output ripple can be further reduced by appropriately increasing the input & output capacitor values Cin and Cout and/or by selecting capacitors with a low ESR (equivalent series resistance). Also make sure that the capacitance is not exceeding the specified max. capacitive load value of the product.

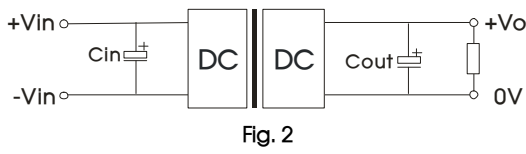

Capacitors value	Cin	Cout
Output voltage		
5VDC	100uF/100V	220uF/63V
12VDC		
15VDC		
24VDC		

3. EMC compliance recommended circuit

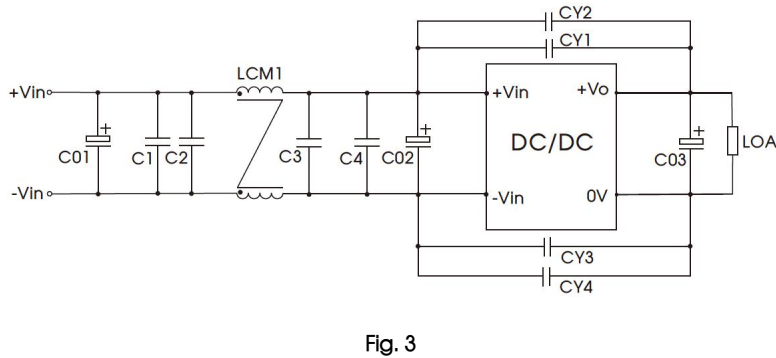

C01	470uF/100V (electrolytic capacitor)
C02	100uF/100V (electrolytic capacitor)
C03	330uF/63V (electrolytic capacitor)
C1, C2, C3, C4	4.7uF/100V
CY1, CY2, CY3, CY4	2.2nF/2KV
LCM1	2mH, recommended to use MORNSUN P/N: FL2D-A2-202(C)

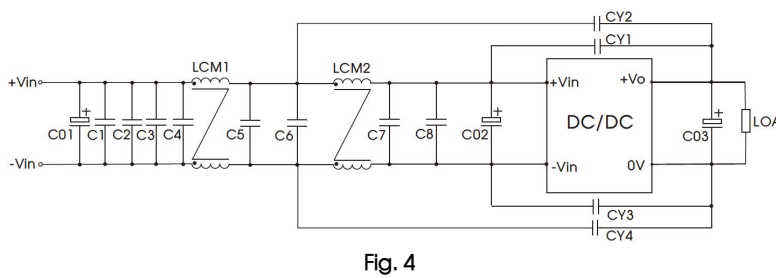

C01	470uF/100V(electrolytic capacitor)
C02	100uF/100V(electrolytic capacitor)
C03	330uF/63V(electrolytic capacitor)
C1, C2, C3, C4, C5, C6, C7, C8	4.7uF/100V
CY1, CY2, CY3, CY4	4.7nF/1.5KV
LCM1, LCM2	2.0mH, recommended to use MORNSUN P/N: FL2D-A2-202(C)

4. Trim Function for Output Voltage Adjustment (open if unused)

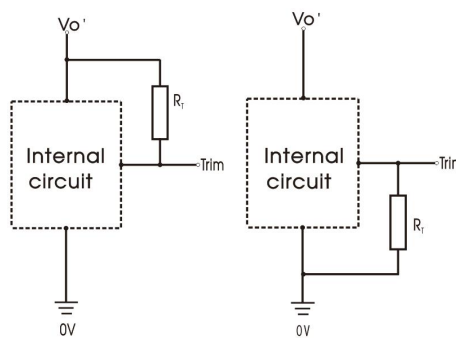

Trim up
Trim down
TRIM resistor connection (dashed line shows internal resistor network)

Note:

RT = Trim Resistor value

$$\Delta\% = \left| \frac{V_{nom} - V_{out}}{V_{nom}} \right| \times 100$$

V_{nom} = nominal output voltage

V_{out} = desired output voltage

Calculating Trim resistor values:

Trim up

$$R_T = \left(\frac{5.11V_{nom}(100 + \Delta\%)}{1.225\Delta\%} - \frac{511}{\Delta\%} - 10.22 \right) (k\Omega)$$

Trim down

$$R_T = \left(\frac{511}{\Delta\%} \right) - 10.22(k\Omega)$$

When the output voltage is 12V, the up-regulated voltage is +10%, that is, the output voltage set to 13.2V:

$$\Delta\% = \left| \frac{12-13.2}{12} \right| * 100 = 10 \quad R_T = \frac{5.11 * 12 * (100+10)}{1.225 * 10} - \frac{511}{10} - 10.22 = 489K\Omega$$

When the output voltage is 12V, the down-regulated voltage is -10%, that is, the output voltage set to 10.8V:

$$\Delta\% = \left| \frac{12-10.8}{12} \right| * 100 = 10 \quad R_T = \frac{511}{10} - 10.22 = 40.88K\Omega$$

5. Hot Test Point

The thermal element is installed on the top surface of the product and dissipates heat to the surrounding environment through conduction, convection and radiation. Sufficient heat dissipation conditions should be provided to ensure the reliable operation of the product.

By measuring the temperature of the thermal test point ① in Fig. 5, it can be verified whether the heat dissipation conditions are met.

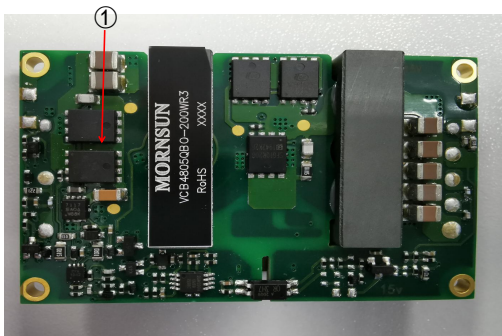

Note:

The temperature of the hot test point ① cannot exceed 130°C, otherwise the product will trigger protection due to excessive temperature and cannot work normally.

6. The products do not support parallel connection of their output

7. For additional information please refer to DC-DC converter application notes on www.mornsun-power.com

VCB48_QBO-200WR3(-N) Dimensions and Recommended Layout

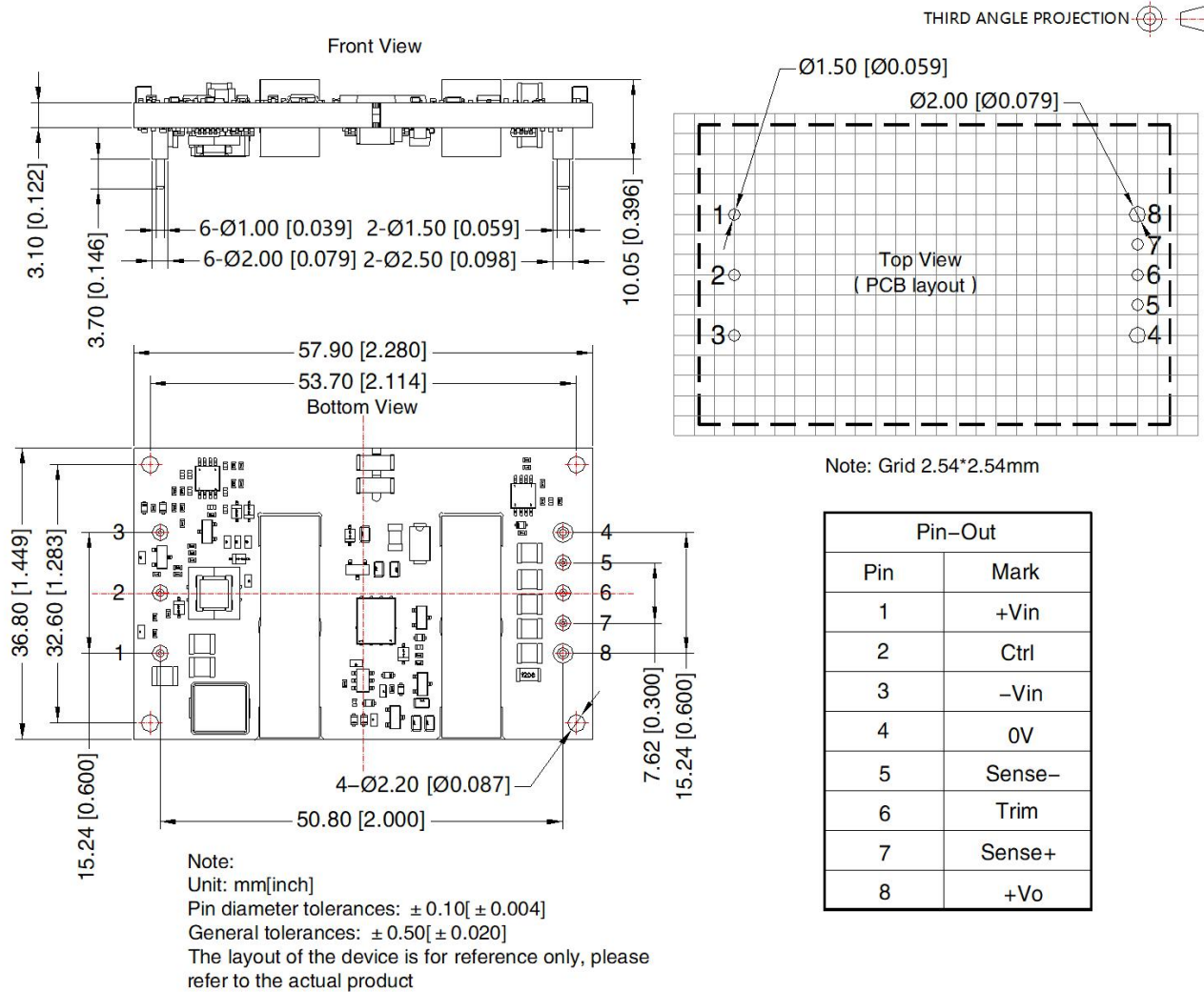

Notes:

- For additional information on Product Packaging please refer to www.mornsun-power.com. Packaging Bag Number : 58010113;
- The maximum capacitive load offered were tested at input voltage range and full load;
- Unless otherwise specified, parameters in this datasheet were measured under the conditions of $T_a=25^\circ\text{C}$, humidity<75%RH with nominal input voltage and rated output load;
- All index testing methods in this datasheet are based on company corporate standards;
- We can provide product customization service, please contact our technicians directly for specific information;
- Products are related to laws and regulations: see "Features" and "EMC";
- Our products shall be classified according to ISO14001 and related environmental laws and regulations, and shall be handled by qualified units.

Mornsun Guangzhou Science & Technology Co., Ltd.

Address: No. 5, Kehui St. 1, Kehui Development Center, Science Ave., Guangzhou Science City, Huangpu District, Guangzhou, P. R. China
Tel: 86-20-38601850 Fax: 86-20-38601272 E-mail: info@mornsun.cn www.mornsun-power.com