

400W isolated DC-DC converter
Wide input and regulated single output



Patent Protection RoHS



EN62368-1 BS EN62368-1

FEATURES

- Wide input voltage range: 36-75VDC
- High efficiency up to 95%
- Basic insulation, I/O isolation test voltage 2250VDC
- Operating ambient temperature range -40°C to +85°C
- Input under-voltage protection, output over-voltage, over-current, short-circuit, over-temperature protection
- Industry standard 1/4-Brick package and pin-out
- Meet EN62368 standards

VCF48_QBO-400W(F/H)R3(-N) series is a high-performance product designed for the field of communication power supply. The DC-DC converters feature 400W output power with no requirement for minimum load, wide input voltage from 36-75VDC, and allowing operating temperature as high as 85°C. Additional product features include input under-voltage protection, output over-voltage, over-current, short-circuit and over-temperature protection, remote On/Off control, remote sense compensation, output voltage trim adjustment. The products meet CLASS B of CISPR32/EN55032 standards by adding the recommended external components, and they are widely used in applications such as battery power supplies, industrial control, electricity, instruments, communication and intelligent robotic.

Selection Guide

Certification	Part No. ^①	Ctrl Logic ^②	Input Voltage (VDC)		Output		Full Load Efficiency(%) Min./Typ.	Max. Capacitive Load(μF)	Min. Capacitive Load ^④ (μF)
			Nominal (Range)	Max. ^③	Voltage (VDC)	Current (mA) (Max./Min.)			
EN/BS EN	VCF4812QBO-400W(F/H)R3	P	48 (36-75)	80	12	33000/0	93/95	10000	470
	VCF4815QBO-400W(F/H)R3				15	26500/0		6800	
	VCF4824QBO-400W(F/H)R3				24	16500/0		3300	
	VCF4828QBO-400W(F/H)R3				28	14200/0		3300	
	VCF4812QBO-400W(F/H)R3-N	N			12	33000/0		10000	
	VCF4815QBO-400W(F/H)R3-N				15	26500/0		6800	
	VCF4824QBO-400W(F/H)R3-N				24	16500/0		3300	
	VCF4828QBO-400W(F/H)R3-N				28	14200/0		3300	

Note:
 ① Use "F" suffix is for added aluminum baseplate and "H" suffix for heat sink mounting. We recommend to choose modules with a heat sink for enhanced heat dissipation and applications with extreme temperature requirements;
 ② "P" means positive logic, "N" means negative logic;
 ③ Exceeding the maximum input voltage may cause permanent damage;
 ④ In order to ensure the output stability, a minimum capacitive load must be connected to the output side of the product.

Input Specifications

Item	Operating Conditions	Min.	Typ.	Max.	Unit	
Input Current(Full load/no load)	Nominal input voltage	VCF4812QBO-400W(F/H)R3(-N)	--	--	8961/120	mA
		VCF4815QBO-400W(F/H)R3(-N)	--	--	8961/150	
		VCF4824QBO-400W(F/H)R3(-N)	--	--	8961/120	
		VCF4828QBO-400W(F/H)R3(-N)	--	--	8961/150	
Reflected Ripple Current	Nominal input voltage	--	200	--	VDC	
Surge Voltage (1sec. max.)		-0.7	--	90		
Start-up Voltage		--	--	36		

Input Under-voltage Protection			30	32	--	
Start-up Time	Nominal input voltage, constant resistance load		--	--	100	ms
Input Filter			LC filter			
Hot Plug			Unavailable			
Ctrl ^①	VCF48_QBO-400W(F/H)R3	Module on	Ctrl open circuit or connected to TTL high level (3.3-12VDC)			
		Module off	Ctrl pin connected to -Vin or low level (0-1.2VDC)			
		Input current when off	--	13	--	mA
		Respond Time	--	--	50	ms
	VCF48_QBO-400W(F/H)R3-N	Module on	Ctrl pin pulled low to GND (0-1.2VDC)			
		Module off	Ctrl pin open or pulled high (TTL 4.5-12VDC)			
		Input current when off	--	13	--	mA
		Respond Time	--	--	50	ms

Note: ①The Ctrl pin voltage is referenced to input -Vin.

Output Specifications

Item	Operating Conditions		Min.	Typ.	Max.	Unit
Voltage Accuracy			--	±1	±3	
Linear Regulation	Input voltage variation from low to high at full load		--	±0.2	±0.5	%
Load Regulation	5%-100% load		--	±0.5	±0.75	
Transient Recovery Time	25% load step change, nominal input voltage		--	300	500	μs
Transient Response Deviation			--	±3	±5	%
Temperature Coefficient	Full load		--	--	±0.03	%/°C
Ripple & Noise ^①	Nominal input voltage, 100%Io	VCF4812QBO-400W(F/H)R3(-N)	--	--	150	mVp-p
		VCF4815QBO-400W(F/H)R3(-N)	--	--	150	
		VCF4824QBO-400W(F/H)R3(-N)	--	--	220	
		VCF4828QBO-400W(F/H)R3(-N)	--	--	220	
Trim			90	--	110	%Vo
Sense			--	--	105	
Over-temperature Protection	Max. Case Temperature		--	110	120	°C
Over-voltage Protection	Input voltage range		110	130	160	%Vo
Over-current Protection			110	140	170	%Io
Short-circuit Protection			Hiccup, continuous, self-recovery			

Notes: ①The "Tip and barrel" method is used for ripple and noise test, please refer to DC-DC Converter Application Notes for specific information.

General Specifications

Item	Operating Conditions		Min.	Typ.	Max.	Unit
Isolation	Electric Strength Test for 1 minute with a leakage current of 1mA max	Input-output	2250	--	--	VDC
		Input-case	1500	--	--	
		Output-case	500	--	--	
Insulation Resistance	Input-output resistance at 500VDC		100	--	--	MΩ
Isolation Capacitance	Input-output capacitance at 100KHz/0.1V		--	2200	--	pF
Operating Temperature	See temperature derating curves		-40	--	+85	°C
Storage Temperature			-55	--	+125	
Storage Humidity	Non-condensing		5	--	95	%RH
Pin Soldering Resistance Temperature	Wave-soldering, 10 seconds		--	--	260	°C
	Soldering spot is 1.5mm away from case for 10 seconds		--	--	300	

Shock And Vibration		10-150Hz, 5G, 0.75mm. along X, Y and Z			
Switching Frequency	PWM mode	--	280	--	KHz
MTBF	MIL-HDBK-217F@25°C	1000	--	--	K hours

Mechanical Specifications

Case Material	Aluminum alloy case				
Dimension	VCF48_QBO-400WR3(-N)	57.9 x 36.8 x 12.9 mm			
	VCF48_QBO-400WHR3(-N)	57.9 x 36.8 x 25.6 mm			
	VCF48_QBO-400WFR3(-N)	62.0 x 56.0 x 14.7 mm			
Weight	VCF48_QBO-400WR3(-N)	71.4g(Typ.)			
	VCF48_QBO-400WHR3(-N)	102.8g(Typ.)			
	VCF48_QBO-400WFR3(-N)	91.4g(Typ.)			
Cooling Method	Free air convection or forced air convection				

Electromagnetic Compatibility (EMC)

Emissions	CE	CISPR32/EN55032 CLASS A (see Fig.6-1 for recommended circuit)			
		CISPR32/EN55032 CLASS B (see Fig.6-2 for recommended circuit)			
	RE	CISPR32/EN55032 CLASS A (see Fig.6-1 for recommended circuit)			
		CISPR32/EN55032 CLASS B (see Fig.6-2 for recommended circuit)			
Immunity	ESD	IEC61000-4-2	Contact ±6KV, Air ±8KV	perf.Criteria B	
	RS	IEC61000-4-3	10V/m (see Fig.6-2 for recommended circuit)	perf.Criteria A	
	EFT	IEC61000-4-4	±2KV (see Fig.6-1 or Fig.6-2 for recommended circuit)	perf.Criteria A	
	Surge	IEC/EN61000-4-5	line to line ±2KV (see Fig.6-1 or Fig.6-2 for recommended circuit)	perf.Criteria B	
	CS	IEC61000-4-6	10Vr.m.s (see Fig.6-2 for recommended circuit)	perf.Criteria A	

Typical Performance Curves

VCF4812QBO-400W(F/H)R3(-N)
Efficiency VS Output Load

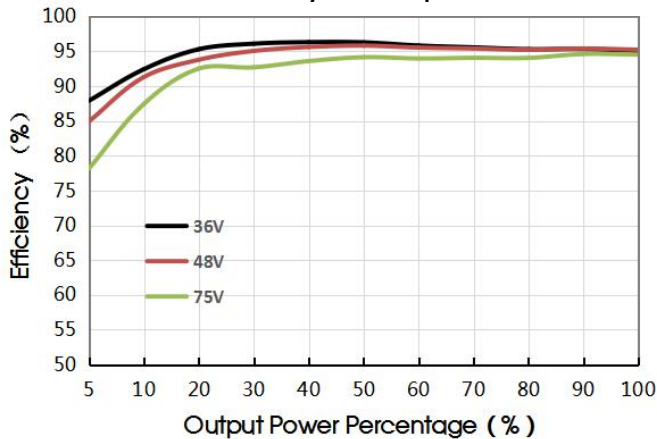

VCF4812QBO-400W(F/H)R3(-N)
Efficiency VS Input Voltage

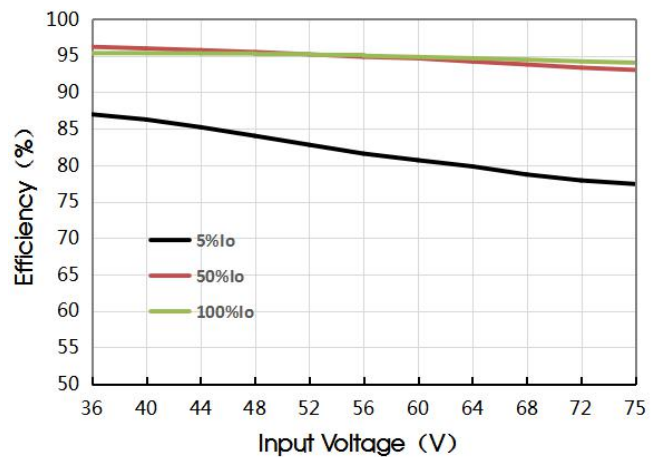

VCF4815QBO-400W(F/H)R3(-N)
Efficiency VS Output Load

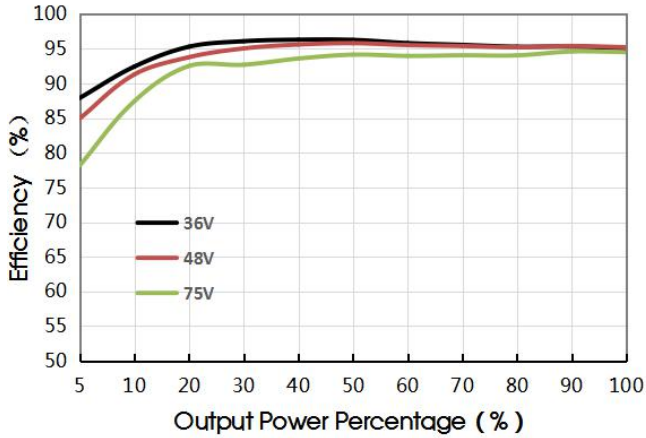

VCF4815QBO-400W(F/H)R3(-N)
Efficiency VS Input Voltage

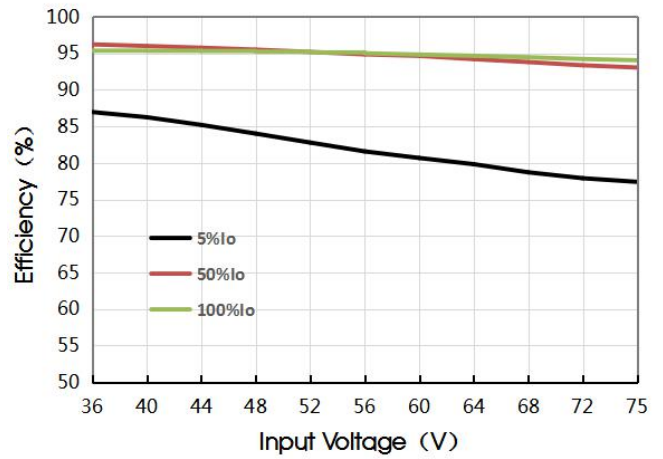

VCF4824QBO-400W(F/H)R3(-N)
Efficiency VS Output Load

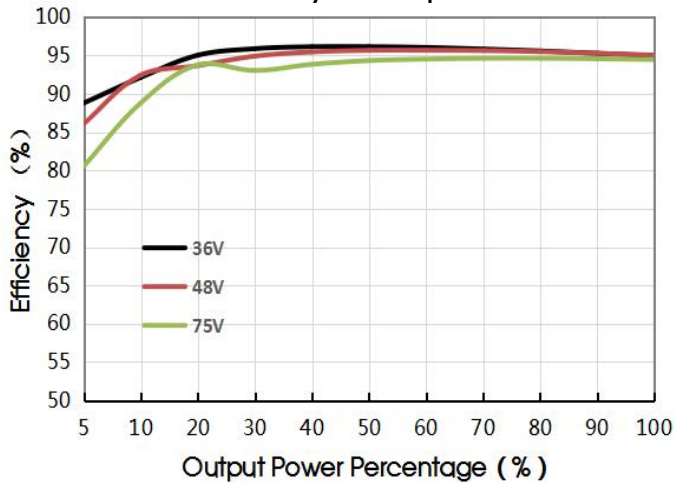

VCF4824QBO-400W(F/H)R3(-N)
Efficiency VS Input Voltage

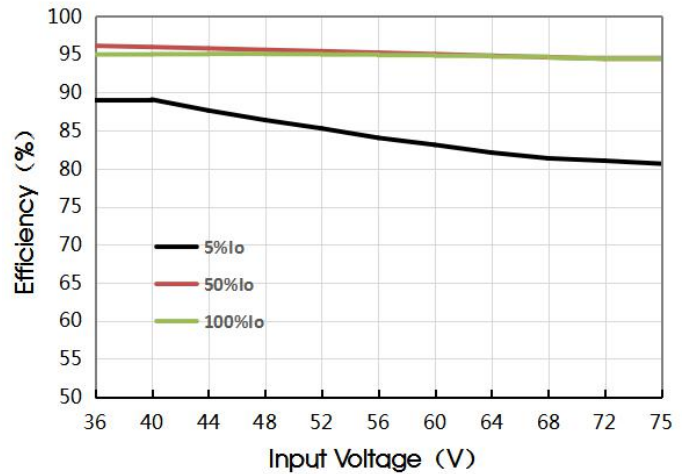

VCF4828QBO-400W(F/H)R3(-N)
Efficiency VS Output Load

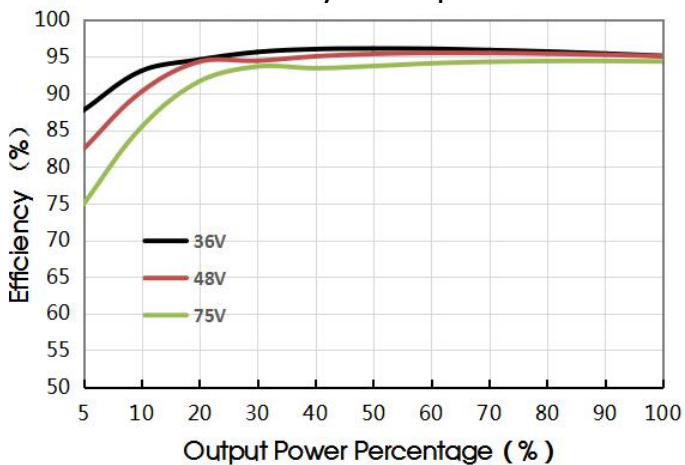

VCF4828QBO-400W(F/H)R3(-N)
Efficiency VS Input Voltage

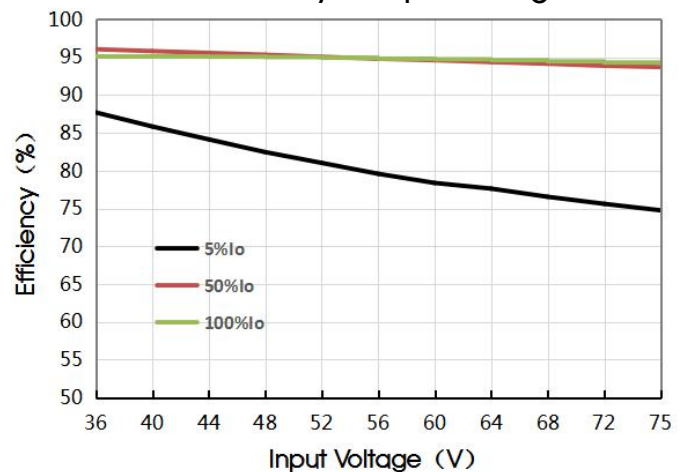

VCF4812QBO-400WR3(-N)
Temperature Derating Curves(Vin=48V)

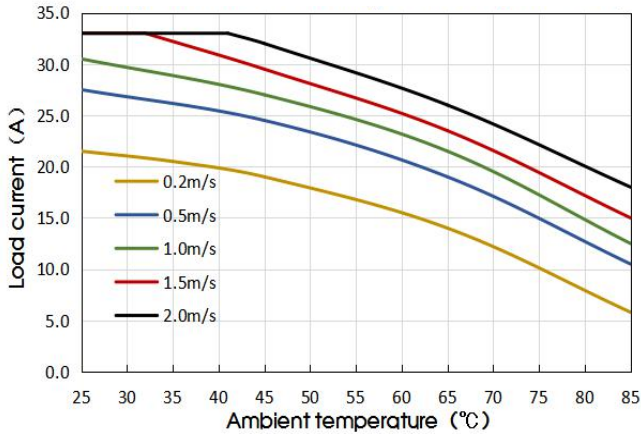

VCF4815QBO-400WR3(-N)
Temperature Derating Curves(Vin=48V)

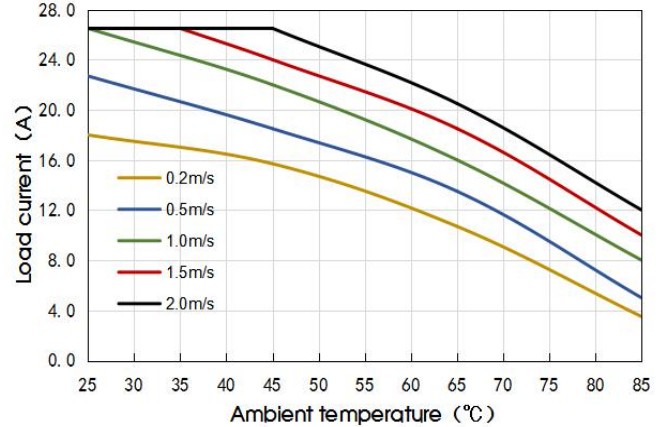

VCF4824QBO-400WR3(-N)
Temperature Derating Curves(Vin=48V)

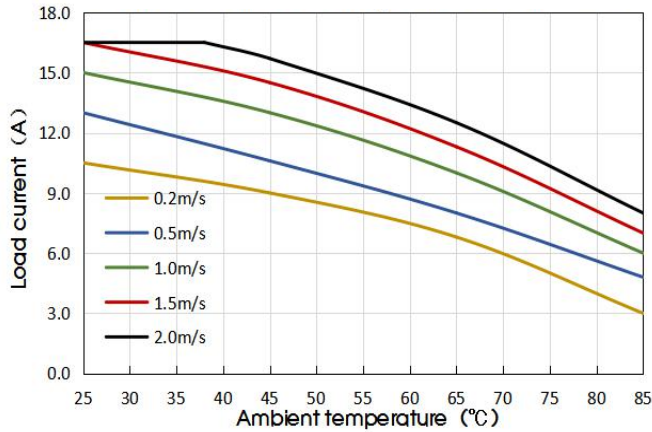

VCF4828QBO-400WR3(-N)
Temperature Derating Curves(Vin=48V)

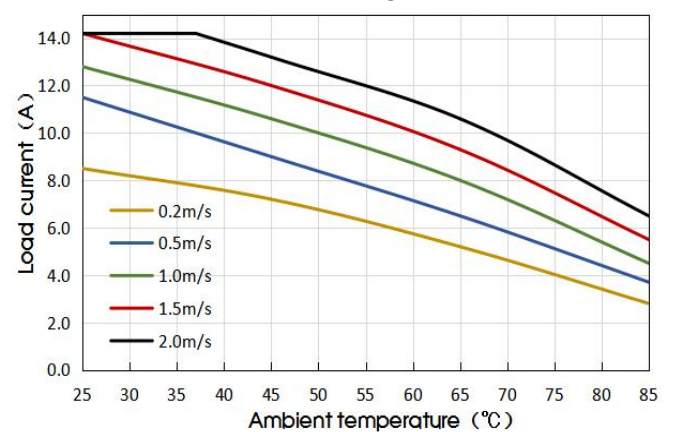

VCF4812QBO-400WHR3(-N)
Temperature Derating Curves(Vin=48V)

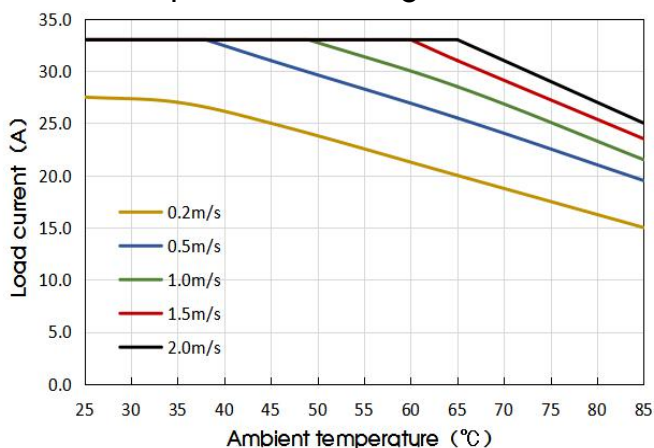

VCF4815QBO-400WHR3(-N)
Temperature Derating Curves(Vin=48V)

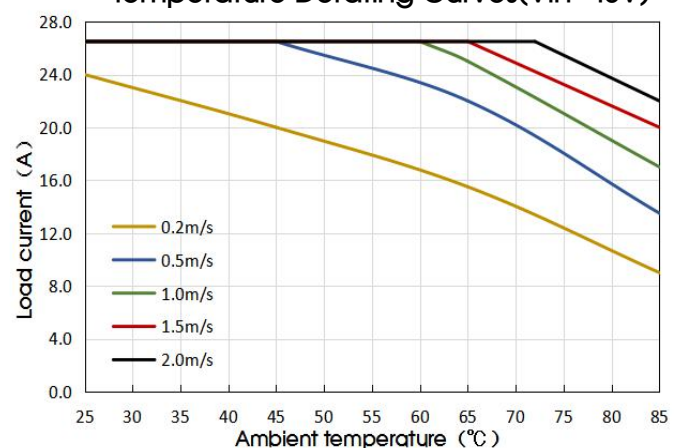

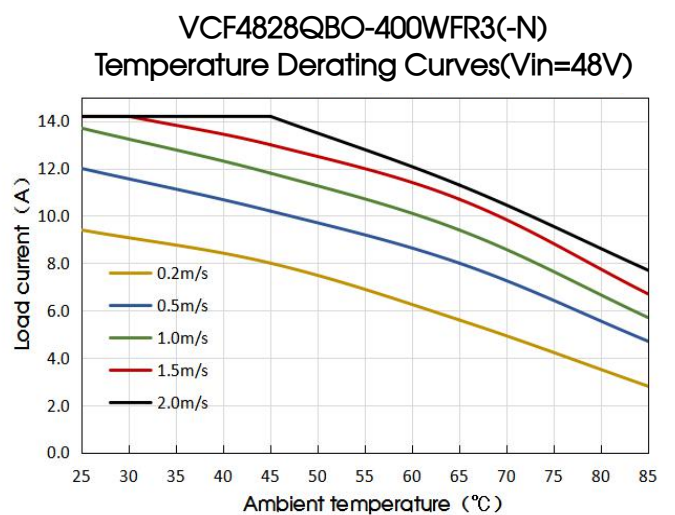
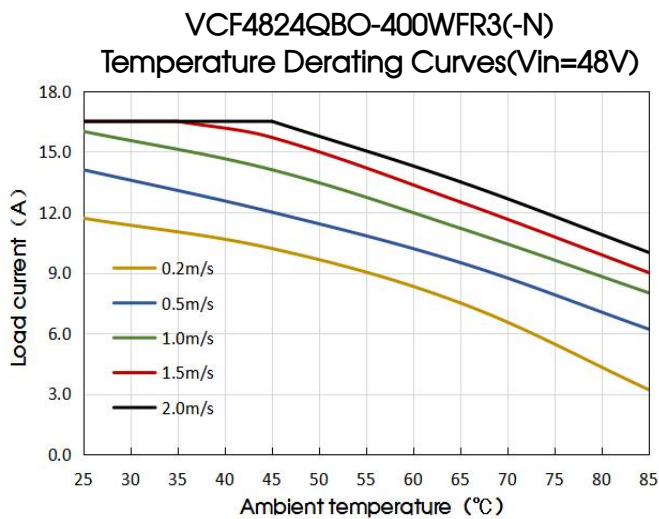
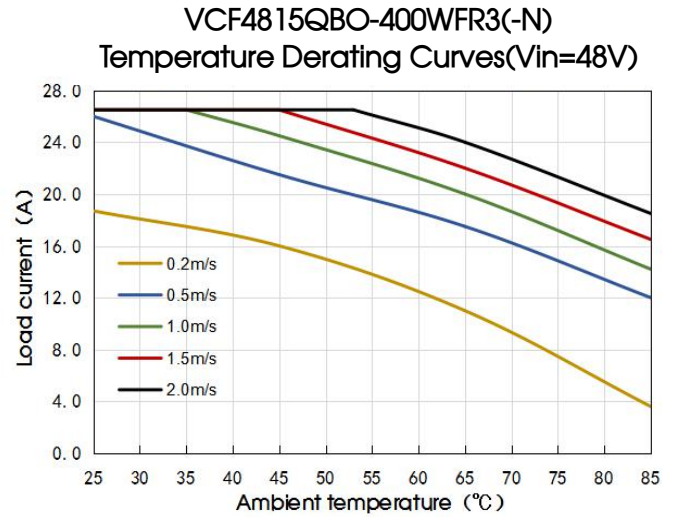
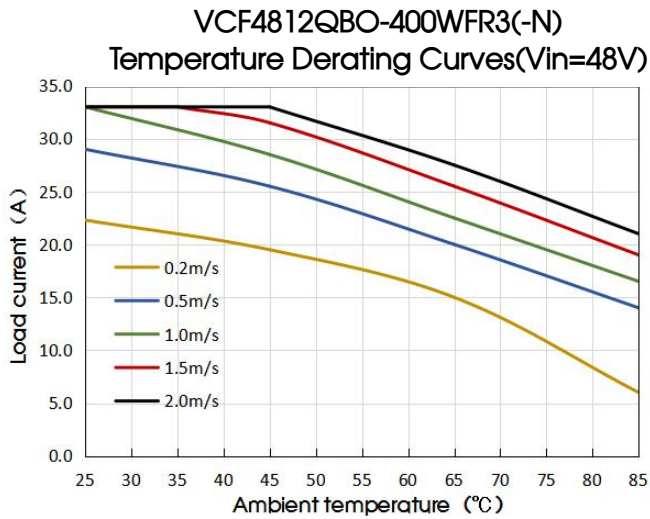
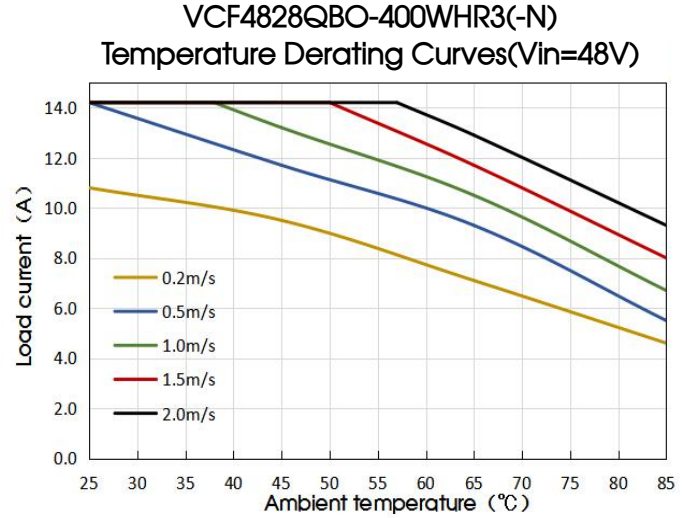
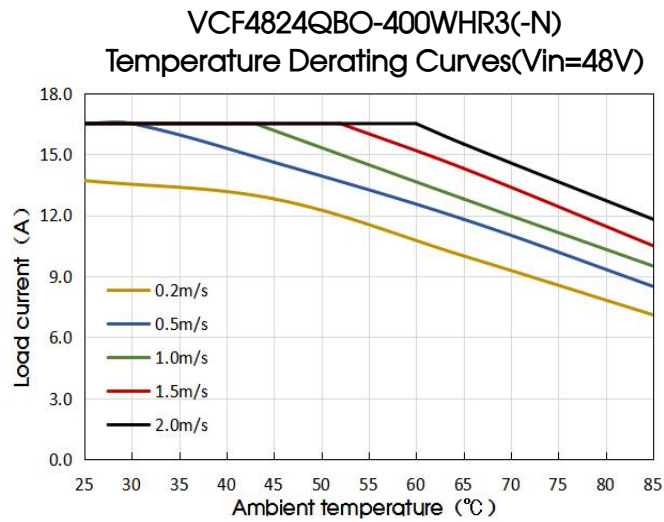

Fig.1

Remote Sense Application

1. Remote Sense Connection if not used

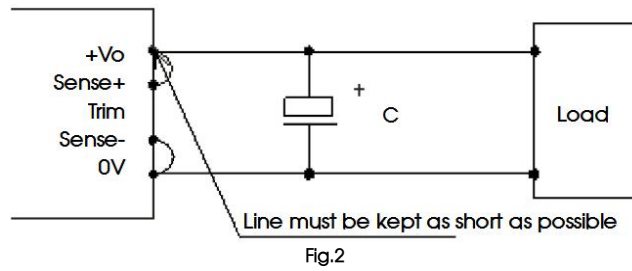

Fig.2

Notes:

- (1) If the sense function is not used for remote regulation the user must connect the +Sense to +Vo and -Sense to 0V at the DC-DC converter pins and will compensate for voltage drop across pins only.
- (2) The connections between sense lines and their respective power lines must be kept as short as possible, otherwise they may be picking up noise, interference and/or causing unstable operation of the power module.

2. Remote Sense Connection used for Compensation

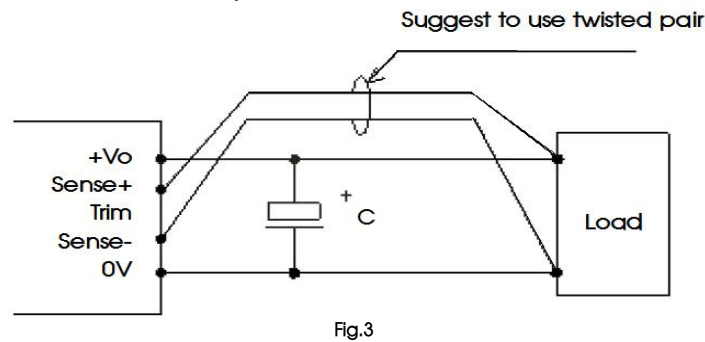

Fig.3

Notes:

- (1) Using remote sense with long wires may cause unstable output, please contact technical support if long wires must be used.
- (2) PCB-tracks or cables/wires for Remote Sense must be kept as short as possible. Twisted pair or shielded wires are suggested for remote compensation and must be kept as short as possible.
- (3) We recommend using adequate cross section for PCB-track layout and/or cables to connect the power supply module to the load in order to keep the voltage drop below 0.3V and to make sure the power supply's output voltage remains within the specified range.
- (4) Note that large wire impedance may cause oscillation of the output voltage and/or increased ripple. Consult technical support or factory for further advice of sense operation.

Design Reference

1. Typical application

We recommended using the recommended circuit shown in Fig.6-1 or Fig.6-2 during product testing and application, otherwise please ensure that at least a 220 μ F electrolytic capacitor is connected at the input in order to ensure adequate voltage surge suppression, and a minimum capacitive load must be connected at the output in order to ensure the output stability. Input and/or output ripple can be further reduced by appropriately increasing the input & output capacitor values C_{in} and C_{out} and/or by selecting capacitors with a low ESR (equivalent series resistance). Also make sure that the capacitance is not exceeding the specified max. capacitive load value of the product.



Fig.5

Capacitor Value	C_{out}	C_{in}
Output Voltage		
12V/15V/24V/28V	470 μ F	220 μ F

2. EMC compliance circuit

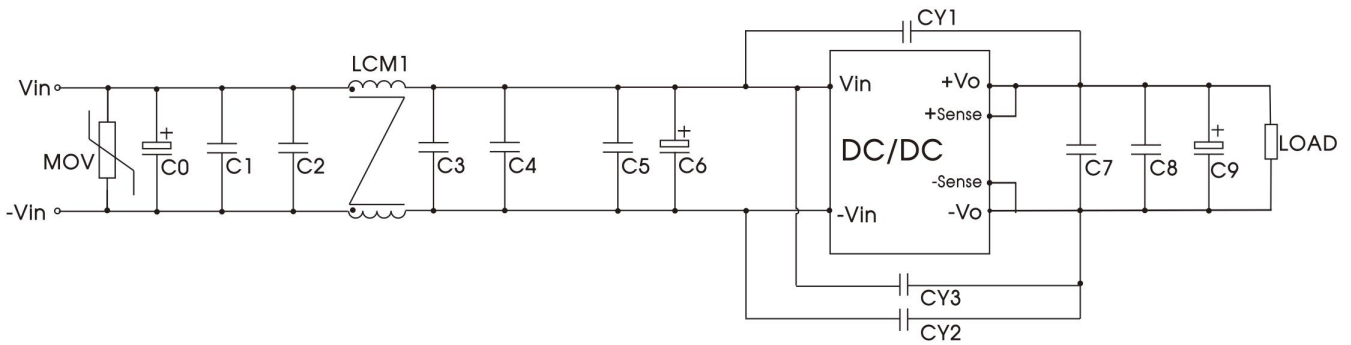

Fig. 6-1

Components	Recommended Component Value
MOV	S14K60 Varistor
C0	680 μ F/100V electrolytic capacitor
C6	470 μ F/100V electrolytic capacitor
C9	470 μ F/63V electrolytic capacitor
C1, C2, C3, C4, C5, C7, C8	4.7 μ F/100V ceramic capacitor
LCM1	T24 x 23.5 x 19/4mH/35m Ω max
CY1, CY2, CY3	1nF/400VAC Y1 safety capacitor

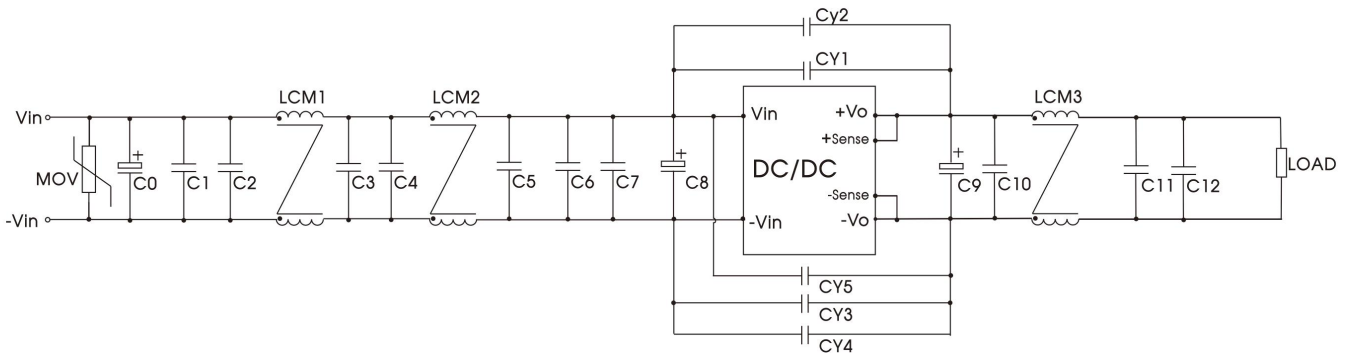

Fig. 6-2

Components	Recommended Component Value
MOV	S14K60 Varistor
C0	680 μ F/100V electrolytic capacitor
C8	470 μ F/100V electrolytic capacitor
C9	470 μ F/63V electrolytic capacitor
C1, C2, C3, C4, C5, C6, C7, C10, C11, C12	4.7 μ F/100V ceramic capacitor
LCM1, LCM2	T24 x 23.5 x 19/4mH/35m Ω max
LCM3	T28 x 27.5 x 12/100uH/5m Ω max
CY1, CY2, CY3, CY4, CY5	1nF/400VAC Y1 safety capacitor

3. Trim function for output voltage adjustment (open if unused)

Calculation formula of Trim resistance:

Trim up

$$R_T = \left(\frac{5.11V_{nom}(100 + \Delta\%)}{1.225\Delta\%} - \frac{511}{\Delta\%} - 10.22 \right) (k\Omega)$$

Trim down

$$R_T = \left(\frac{511}{\Delta\%} \right) - 10.22 (k\Omega)$$

Note:

R_T: Resistance of Trim.

$$\Delta\% = \left| \frac{V_{nom} - V_{out}}{V_{nom}} \right| \times 100$$

V_{nom}: Nominal Input Voltage.

V_{out}: The trim up/down voltage.

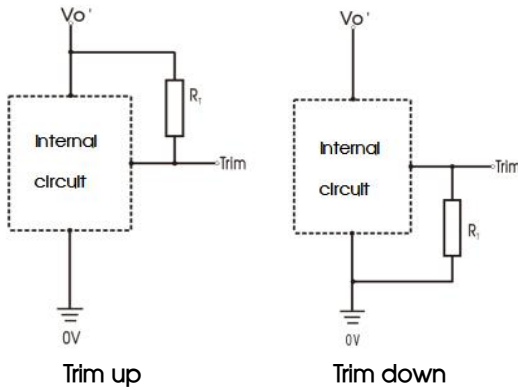

TRIM resistor connection (dashed line shows internal resistor network)
Fig. 7

4. Recommended solution for thermal testing

During the application process, the thermal design of the product can be evaluated in combination with the temperature derating curve of the product, or it can be determined by testing the temperature at point A, it is a safe operating area if the temperature lower than 125°C.

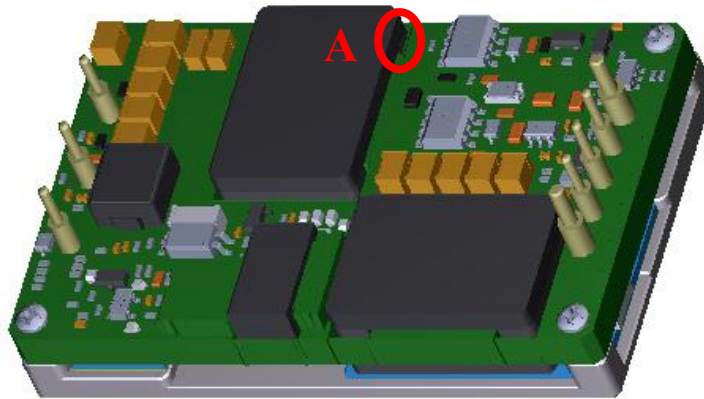

Fig. 8

5. Reflected ripple current test circuit

All DC-DC converters of this series are tested using the recommended circuit shown in Fig. 9.

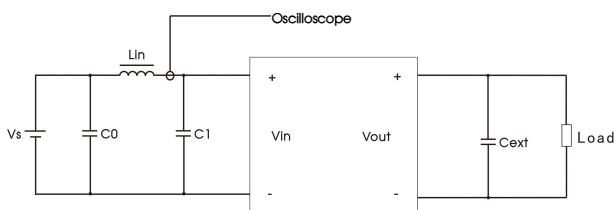

Fig. 9

Components	Recommended Component Value
C0	220µF/100V
Lin	10uH/15A
C1	470µF/100V
Cext	470µF/63V

6. The products do not support parallel connection of their output

7. For additional information please refer to DC-DC converter application notes on

www.mornsun-power.com

VCF48_QBO-400WR3 Dimensions and Recommended Layout

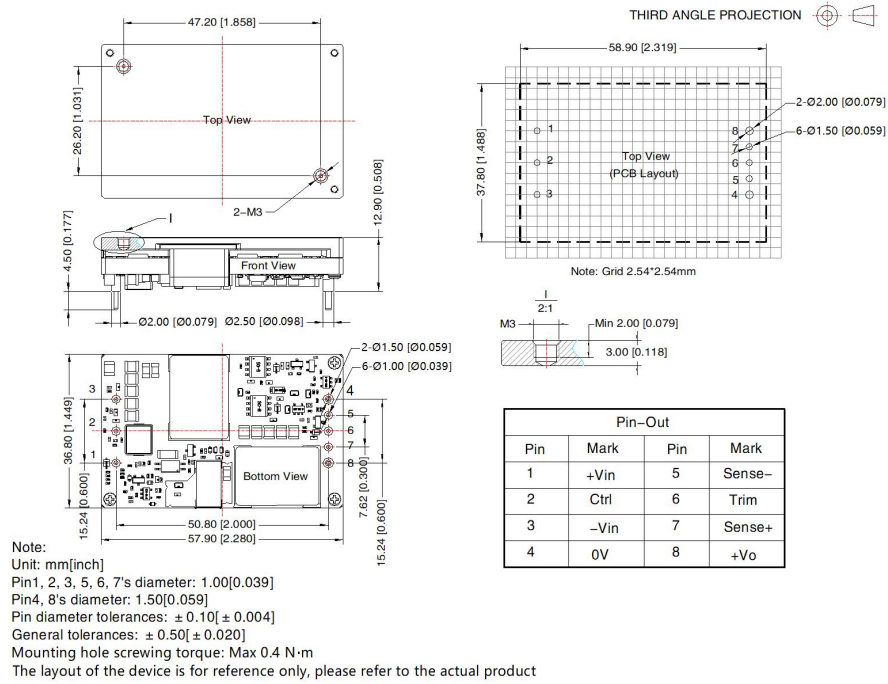

VCF48_QBO-400WR3-N Dimensions and Recommended Layout

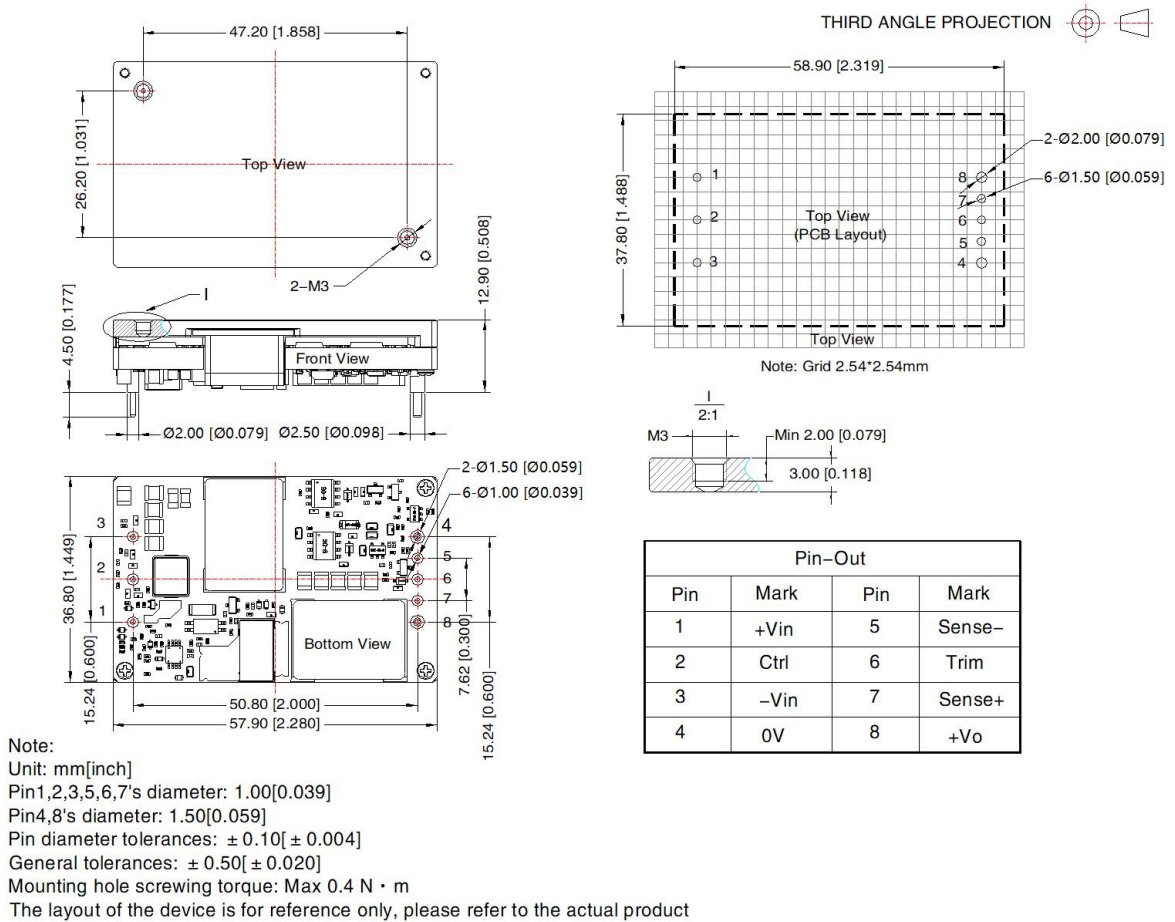

VCF48_QBO-400WHR3 Dimensions and Recommended Layout

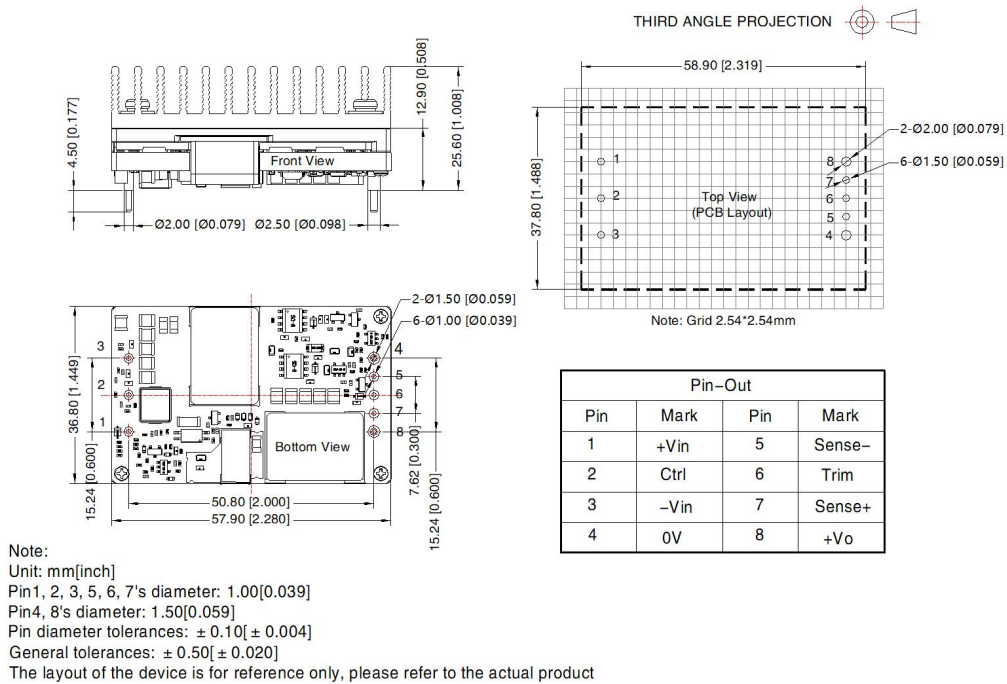

VCF48_QBO-400WHR3-N Dimensions and Recommended Layout

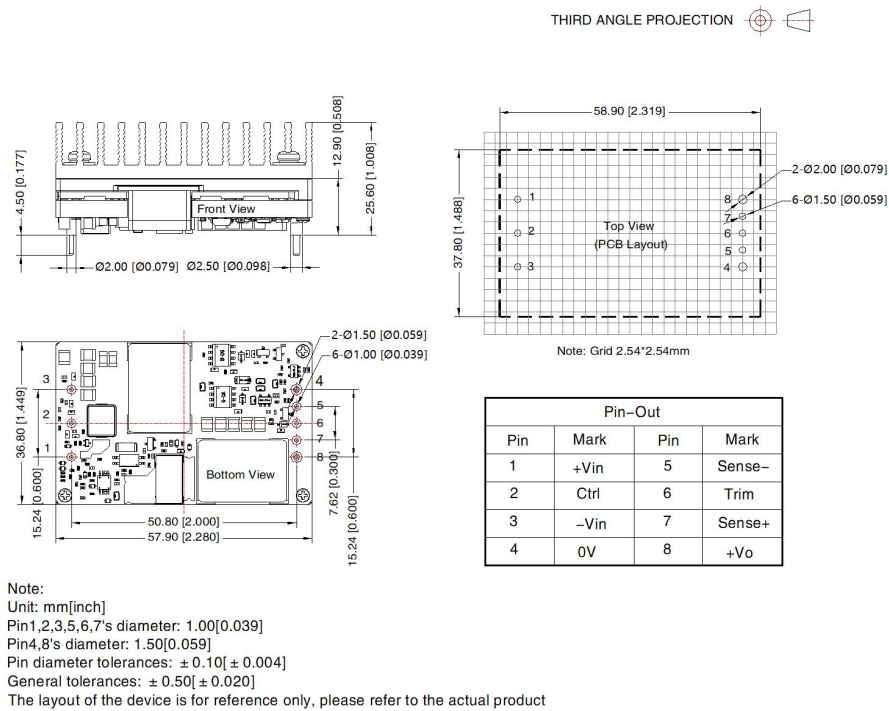

VCF48_QBO-400WFR3 Dimensions and Recommended Layout

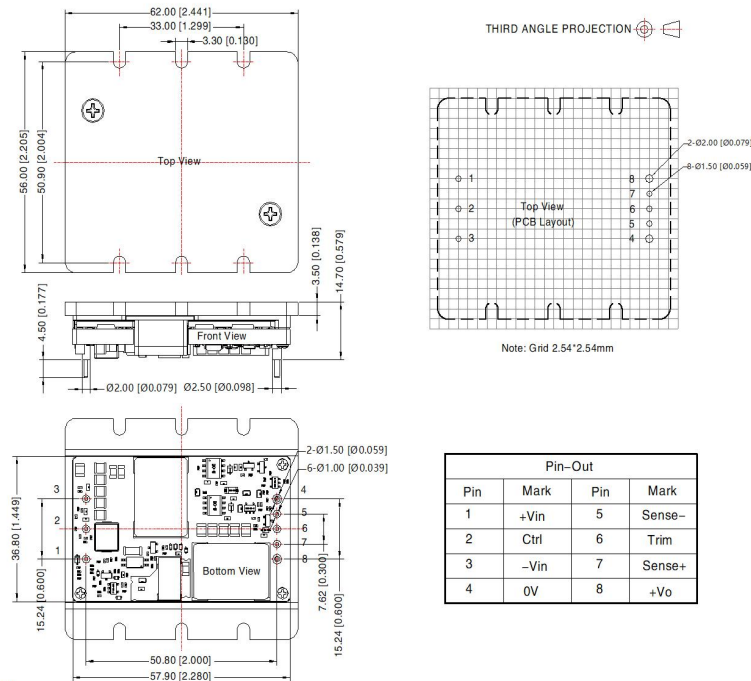

Note:
Unit: mm[inch]
Pin1, 2, 3, 5, 6, 7's diameter: 1.00[0.039]
Pin4, 8's diameter: 1.50[0.059]
Pin diameter tolerances: $\pm 0.10[\pm 0.004]$
General tolerances: $\pm 0.50[\pm 0.020]$
The layout of the device is for reference only, please refer to the actual product

VCF48_QBO-400WFR3-N Dimensions and Recommended Layout

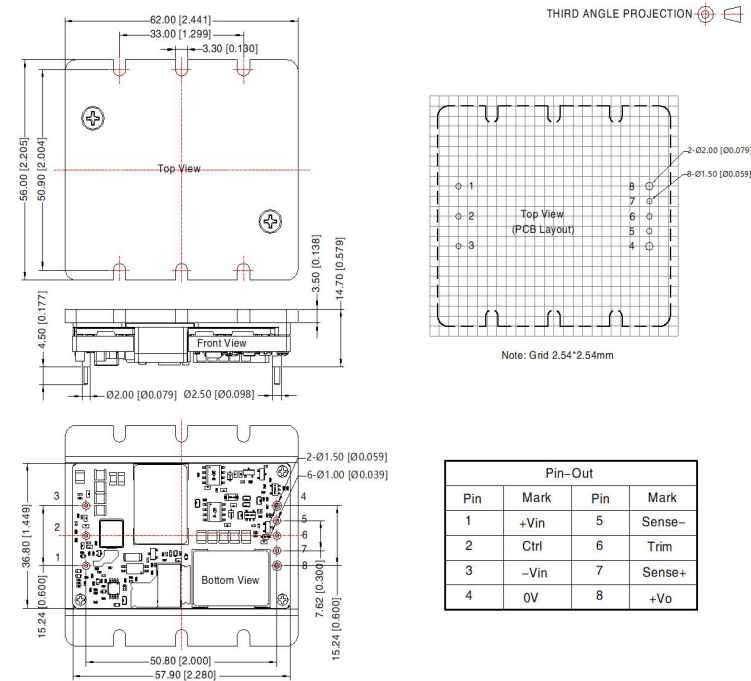

Note:
Unit: mm[inch]
Pin1, 2, 3, 5, 6, 7's diameter: 1.00[0.039]
Pin4, 8's diameter: 1.50[0.059]
Pin diameter tolerances: $\pm 0.10[\pm 0.004]$
General tolerances: $\pm 0.50[\pm 0.020]$
The layout of the device is for reference only, please refer to the actual product

Notes:

1. For additional information on Product Packaging please refer to www.mornsun-power.com. Packing bag number: 58010113(VCF48xxQBO-400WR3(-N)), 58220017(VCF48xxQBO-400WHR3(-N)), 58200069(VCF48xxQBO-400WFR3(-N));
2. The maximum capacitive load offered were tested at input voltage range and full load;
3. Unless otherwise specified, parameters in this datasheet were measured under the conditions of Ta=25°C, humidity<75%RH with nominal input voltage and rated output load;
4. All index testing methods in this datasheet are based on company corporate standards;
5. We can provide product customization service, please contact our technicians directly for specific information;
6. Products are related to laws and regulations: see "Features" and "EMC";
7. Our products shall be classified according to ISO14001 and related environmental laws and regulations, and shall be handled by qualified units.

Mornsun Guangzhou Science & Technology Co., Ltd.

Address: No. 5, Kehui St. 1, Kehui Development Center, Science Ave., Guangzhou Science City, Huangpu District, Guangzhou, P. R. China
Tel: 86-20-38601850 Fax: 86-20-38601272 E-mail: info@mornsun.cn www.mornsun-power.com