

## 20V N-Channel Enhancement Mode MOSFET

### Description

The NP2302C uses advanced trench technology to provide excellent  $R_{DS(ON)}$ , low gate charge and high density cell Design for ultra low on-resistance. This device is suitable for use as a load switch or in PWM applications.

### General Features

- ◆  $V_{DS} = 20V$ ,  $I_D = 3A$   
 $R_{DS(ON)}(Typ.) = 41m\Omega$  @  $V_{GS} = 2.5V$   
 $R_{DS(ON)}(Typ.) = 31m\Omega$  @  $V_{GS} = 4.5V$
- ◆ High power and current handling capability
- ◆ Lead free product is acquired
- ◆ Surface mount package

### Application

- ◆ PWM applications
- ◆ Load switch

### Package

- ◆ SOT-23



### Schematic diagram

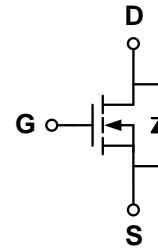

### Marking and pin assignment

SOT-23  
(TOP VIEW)

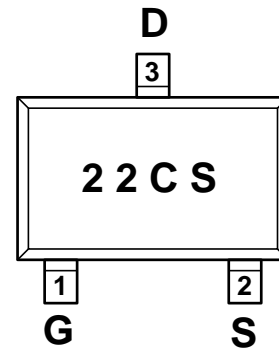

### Ordering Information

Part Number	Storage Temperature	Package	Devices Per Reel
NP2302CVR-G	-55°C to +150°C	SOT-23	3000

### Absolute Maximum Ratings (TA=25°C unless otherwise noted)

parameter	symbol	limit	unit
Drain-source voltage	$V_{DS}$	20	V
Gate-source voltage	$V_{GS}$	±12	V
Drain current-continuous <sup>a</sup> @ $T_j = 125^\circ C$ -pulse <sup>b</sup>	$I_D$	3	A
	$I_{DM}$	12	A
Drain-source Diode forward current	$I_S$	1.6	A
Maximum power dissipation	$P_D$	1.25	W
Operating junction Temperature range	$T_j$	-55—150	°C

**Electrical Characteristics** (TA=25°C unless otherwise noted)

Parameter	Symbol	Condition	Min	Typ	Max	Unit
<b>OFF Characteristics</b>						
Drain-source breakdown voltage	$BV_{DSS}$	$V_{GS}=0V, I_D=250\mu A$	20	-	-	V
Zero gate voltage drain current	$I_{DSS}$	$V_{DS}=20V, V_{GS}=0V$	-	-	1	$\mu A$
Gate-body leakage	$I_{GSS}$	$V_{DS}=0V, V_{GS}=\pm 12V$	-	-	$\pm 100$	nA
<b>ON Characteristics</b>						
Gate threshold voltage	$V_{GS(th)}$	$V_{DS}=V_{GS}, I_D=250\mu A$	0.5	0.75	1.2	V
Drain-source on-state resistance	$R_{DS(on)}$	$V_{GS}=4.5V, I_D=3A$	-	31	50	m $\Omega$
		$V_{GS}=2.5V, I_D=2.8A$		41	80	
Forward transconductance	gfs	$V_{GS}=5V, I_D=3A$	-	5	-	S
<b>Dynamic Characteristics</b>						
Input capacitance	$C_{ISS}$	$V_{DS}=10V, V_{GS}=0V$ $f=1.0MHz$	-	240	-	pF
Output capacitance	$C_{OSS}$		-	45	-	
Reverse transfer capacitance	$C_{RSS}$		-	23	-	
<b>Switching Characteristics</b>						
Turn-on delay time	$t_{D(ON)}$	$V_{DD}=10V$ $R_L=3.3\ ohm$ $V_{GEN}=4.5V$ $R_{GEN}=6ohm$	-	2.3	-	ns
Rise time	$t_r$		-	3.1	-	
Turn-off delay time	$t_{D(OFF)}$		-	21	-	
Fall time	$t_f$		-	2.6	-	
Total gate charge	Qg	$V_{DS}=10V$ $I_D=3A$ $V_{GS}=4.5V$	-	2.7	-	nC
Gate-source charge	Qgs		-	0.4	-	
Gate-drain charge	Qgd		-	0.5	-	
<b>DRAIN-SOURCE DIODE CHARACTERISTICS</b>						
Diode forward voltage	$V_{SD}$	$V_{GS}=0V, I_s=3A$	-	0.76	1.16	V

**Notes:**

- surface mounted on FR4 board,  $t \leq 10sec$
- pulse test: pulse width  $\leq 300\mu s$ , duty  $\leq 2\%$
- guaranteed by design, not subject to production testing

**Thermal Characteristics**

Thermal Resistance junction-to ambient	Rth JA	100	$^{\circ}C/W$
--	--------	-----	---------------

## Typical Performance Characteristics

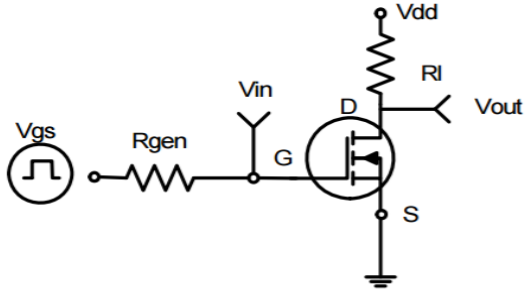

Figure 1: Switching Test Circuit

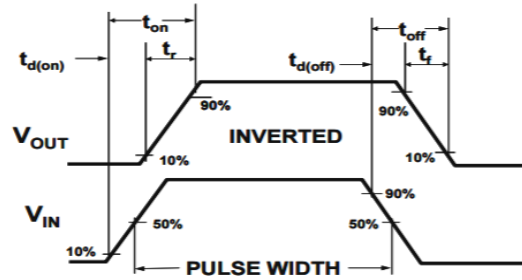

Figure 2: Switching Waveforms

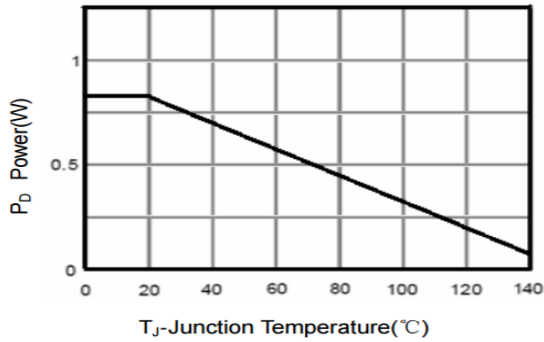

Figure 3 Power Dissipation

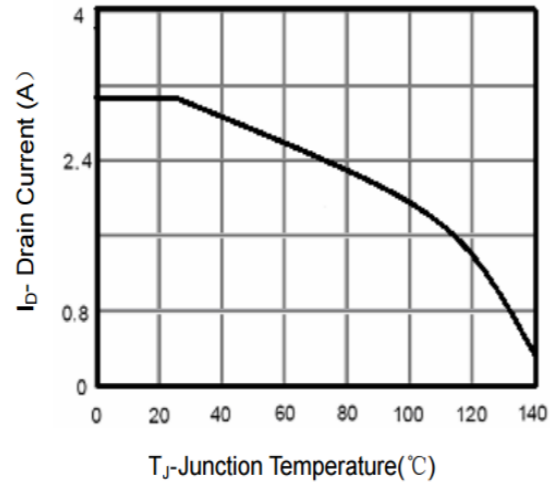

Figure 4 Drain Current

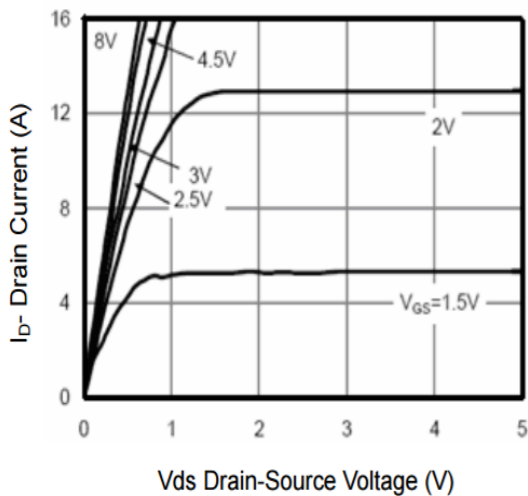

Figure 5 Output Characteristics

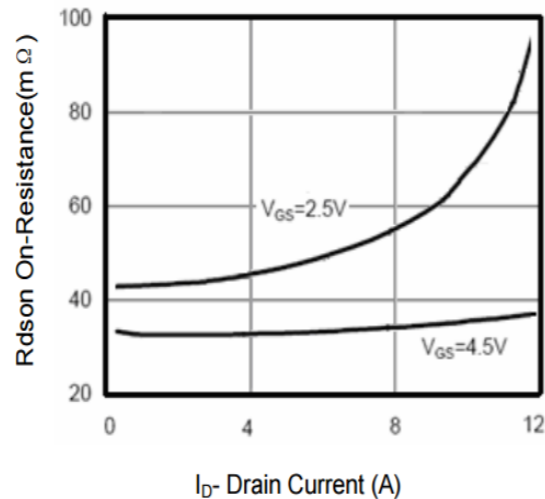

Figure 6 Drain-Source On-Resistance

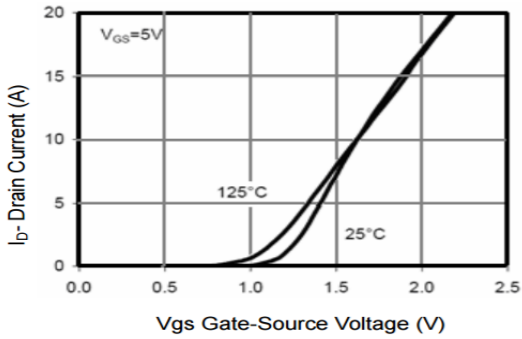

Figure 7 Transfer Characteristics

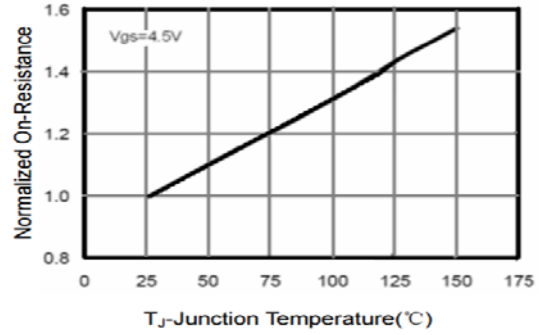

Figure 8 Drain-Source On-Resistance

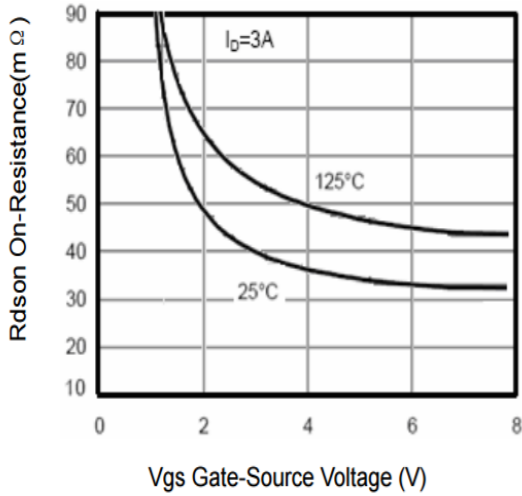

Figure 9 Rdson vs Vgs

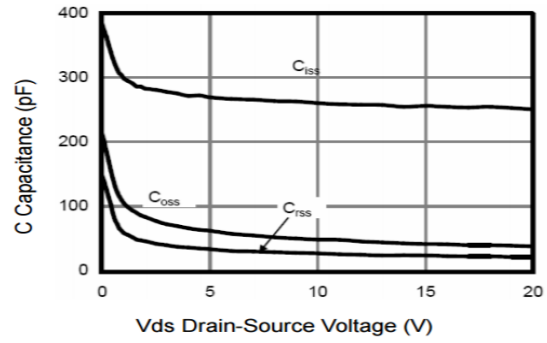

Figure 10 Capacitance vs Vds

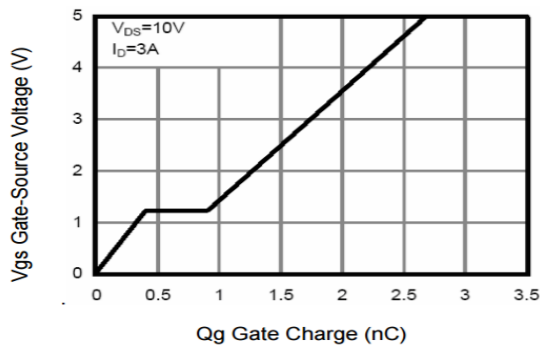

Figure 11 Gate Charge

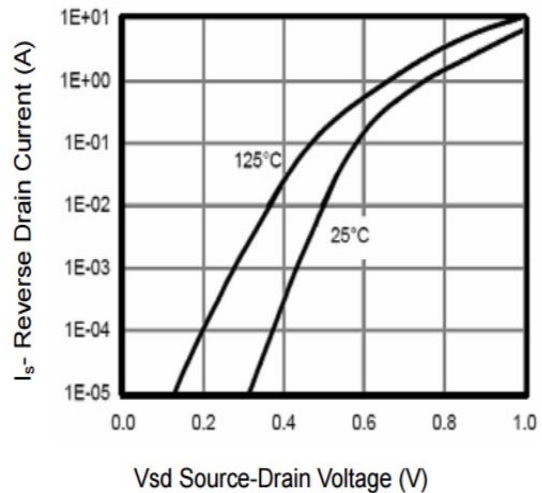

Figure 12 Source- Drain Diode Forward

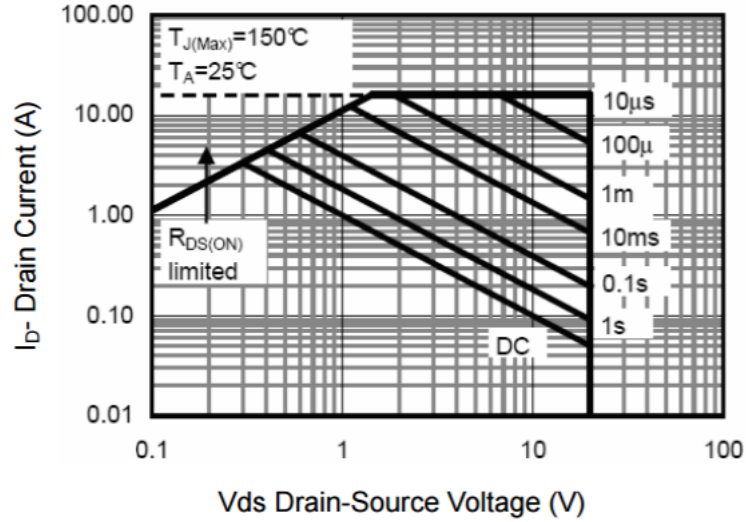

Figure 13 Safe Operation Area

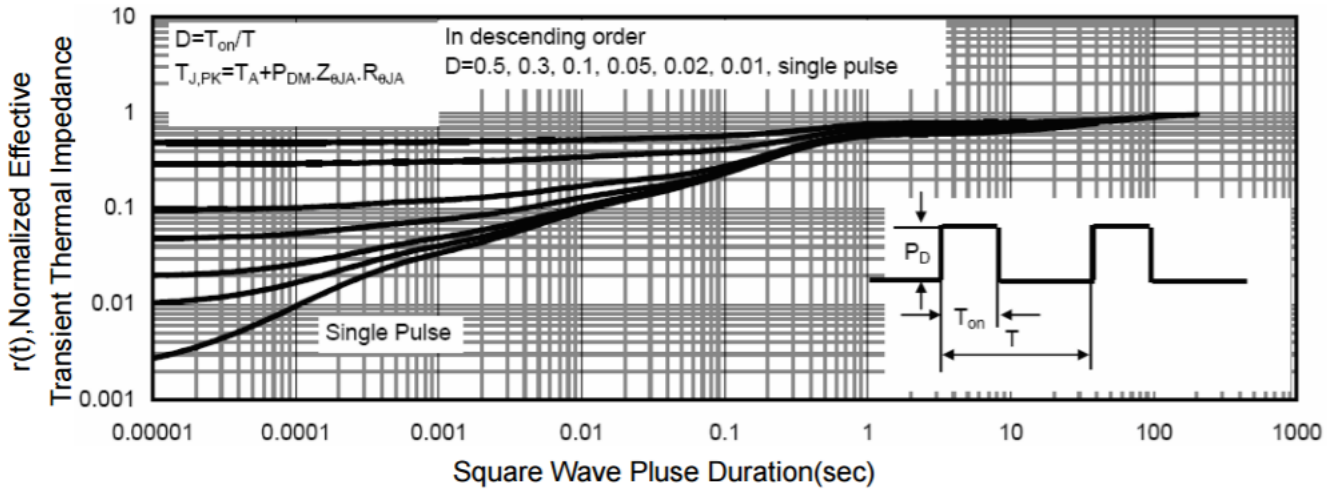
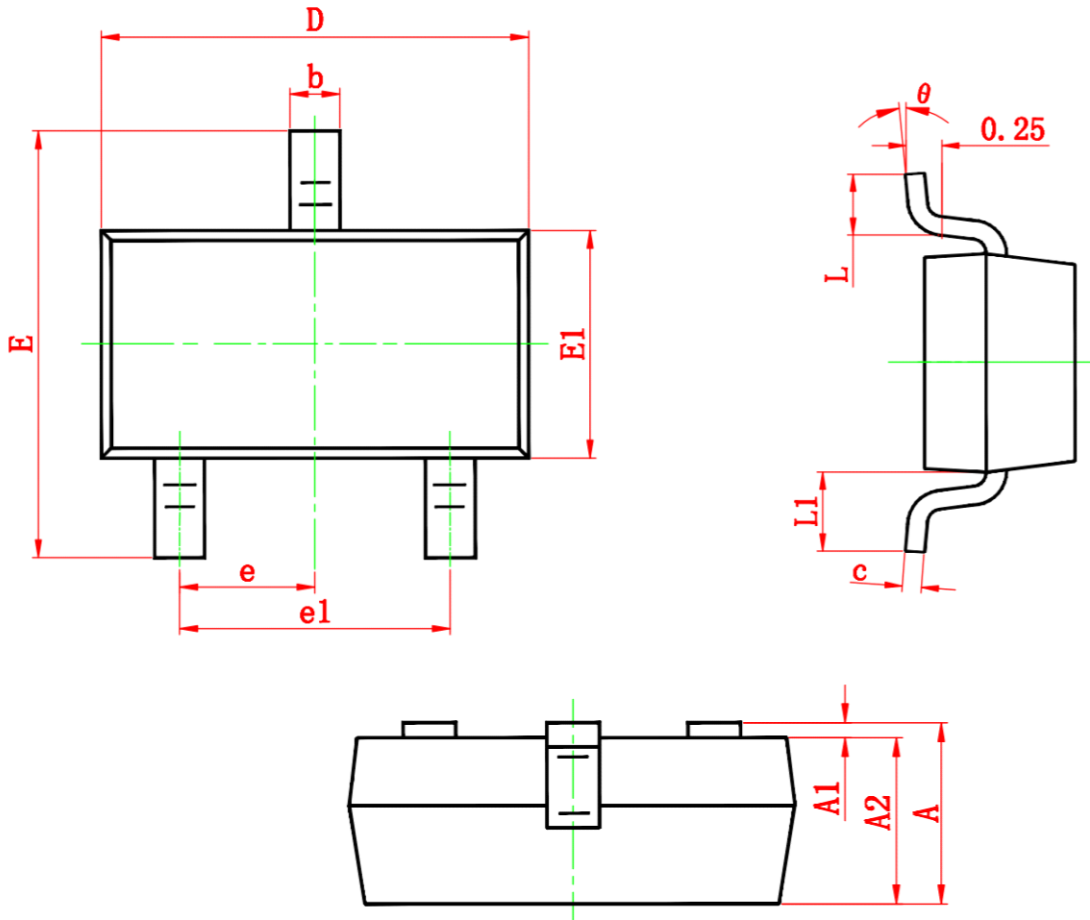

Figure 14 Normalized Maximum Transient Thermal Impedance

## Package Information

- SOT-23



Symbol	Dimensions In Millimeters		Dimensions In Inches	
	Min.	Max.	Min.	Max.
A	0.900	1.150	0.035	0.045
A1	0.000	0.100	0.000	0.004
A2	0.900	1.050	0.035	0.041
b	0.300	0.500	0.012	0.020
c	0.080	0.150	0.003	0.006
D	2.800	3.000	0.110	0.118
E	2.250	2.550	0.089	0.100
E1	1.200	1.400	0.047	0.055
e	0.950 TYP.		0.037 TYP.	
e1	1.800	2.000	0.071	0.079
L	0.300	0.500	0.012	0.020
L1	0.550 REF.		0.022 REF.	
θ	0°	8°	0°	8°