

# MGA-30989

## 2 - 6GHz, High Linearity Gain Block



### Data Sheet

#### Description

Avago Technologies' MGA-30989 is a broadband, high linearity gain block MMIC amplifier achieved through the use of Avago Technologies' proprietary 0.25um GaAs Enhancement-mode pHEMT process.

The device required simple dc biasing components to achieve wide bandwidth performance. The temperature compensated internal bias circuit provides stable current over temperature and process threshold voltage variation.

The MGA-30989 is housed inside a low cost RoHS compliant SOT89 industry standard SMT package (4.5 x 4.1 x 1.5 mm).

#### Component Image

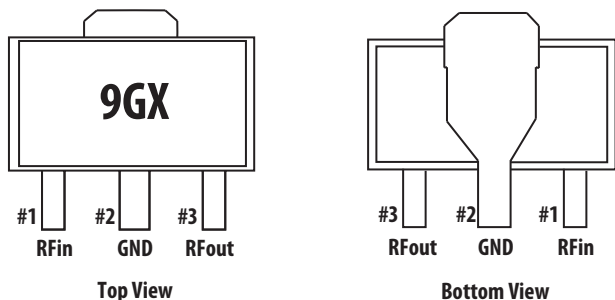

Notes:  
 Package marking provides orientation and identification  
 "9G" = Device Code  
 "X" = Month of Manufacture



**Attention: Observe precautions for handling electrostatic sensitive devices.**  
 ESD Machine Model = 50 V  
 ESD Human Body Model = 1000 V  
 Refer to Avago Application Note A004R: Electrostatic Discharge, Damage and Control.

#### Features

- High linearity
- Built in temperature compensated internal bias circuitry
- No RF matching components required
- GaAs E-pHEMT Technology<sup>[1]</sup>
- Standard SOT89 package
- Single, Fixed 5V supply
- Excellent uniformity in product specifications
- MSL-1 and Lead-free halogen free
- High MTTF for base station application

#### Specifications

##### 3.5GHz, 5V, 51mA (typical)

- 12 dB Gain
- 36.8 dBm Output IP3
- 2 dB Noise Figure
- 23.6 dBm Output Power at 1dB gain compression

##### 5GHz, 5V, 51mA (typical)

- 9.6 dB Gain
- 38.4 dBm Output IP3
- 1.65 dB Noise Figure
- 23.8 dBm Output Power at 1dB gain compression

#### Applications

- IF amplifier, RF driver amplifier
- General purpose gain block

Note:

1. Enhancement mode technology employs positive gate voltage, thereby eliminating the need of negative gate voltage associated with conventional depletion mode devices.

## Absolute Maximum Rating<sup>[1]</sup> T<sub>A</sub>=25°C

Symbol	Parameter	Units	Absolute Max.
V <sub>dd,max</sub>	Device Voltage, RF output to ground	V	5.5
P <sub>in,max</sub>	CW RF Input Power	dBm	24
P <sub>diss</sub>	Total Power Dissipation <sup>[3]</sup>	W	0.47
T <sub>j,MAX</sub>	Junction Temperature	°C	150
T <sub>STG</sub>	Storage Temperature	°C	-65 to 150

## Thermal Resistance

Thermal Resistance<sup>[2]</sup>  $\theta_{JC} = 81.2^{\circ}\text{C}/\text{W}$   
(V<sub>dd</sub> = 5 V, I<sub>ds</sub> = 48 mA, T<sub>c</sub> = 85°C)

Notes:

1. Operation of this device in excess of any of these limits may cause permanent damage.
2. Thermal resistance measured using Infrared measurement technique.
3. This is limited by maximum V<sub>dd</sub> and I<sub>ds</sub>. Derate 12.3 mW/°C for T<sub>c</sub> > 112°C.

## Product Consistency Distribution Charts<sup>[1, 2]</sup>

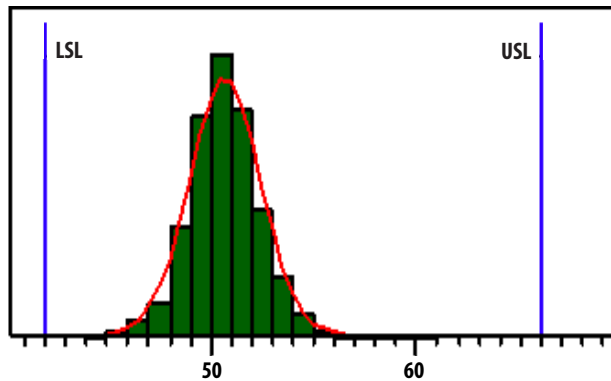

Figure 1. I<sub>ds</sub>, LSL=42mA, nominal=51mA, USL=66mA

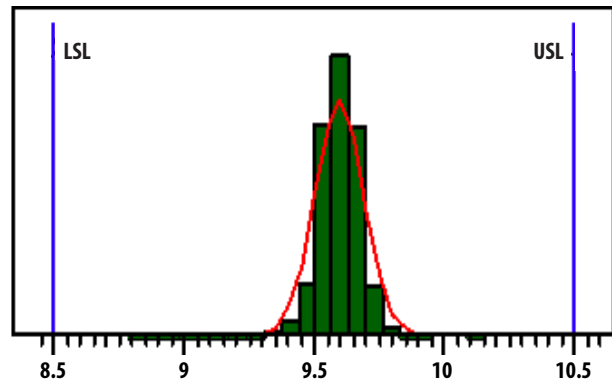

Figure 2. Gain, LSL=8.5dB, nominal=9.6dB, USL=10.5dB

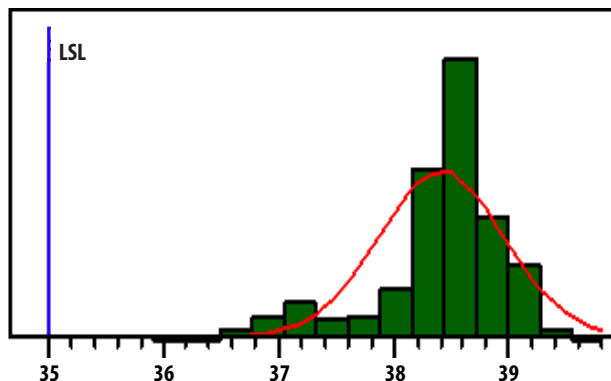

Figure 3. OIP3, LSL=35dBm, nominal=38.4dBm

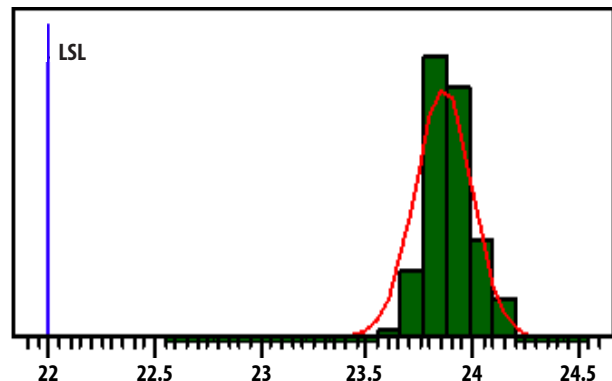

Figure 4. P1dB, LSL=22dBm, nominal=23.8dBm

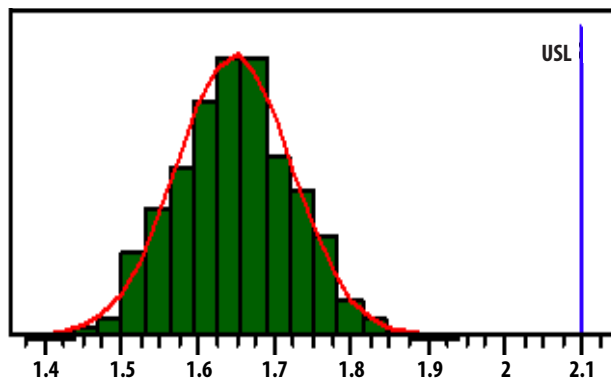

Figure 5. NF, nominal=1.65dB, USL=2.1dB

Notes:

1. Distribution data sample size is 3000 samples taken from 3 different wafer lots. Future wafers allocated to this product may have nominal values anywhere between the upper and lower limits.
2. Measurements were made on a characterization test board, which represents a trade-off between optimal OIP3, gain and P1dB. Circuit trace losses have not been de-embedded from measurements above.

## Electrical Specifications <sup>[1]</sup>

T<sub>A</sub> = 25°C, V<sub>dd</sub> = 5V

Symbol	Parameter and Test Condition	Frequency	Units	Min.	Typ.	Max.
I <sub>ds</sub>	Quiescent current	N/A	mA	42	51	66
Gain	Gain	3.5 GHz 5 GHz	dB	8.5	12 9.6	10.5
OIP3 <sup>[2]</sup>	Output Third Order Intercept Point	3.5 GHz 5 GHz	dBm	35	36.8 38.4	–
NF	Noise Figure	3.5 GHz 5 GHz	dB	–	2 1.65	2.1
S11	Input Return Loss, 50Ω source	3.5 GHz 5 GHz	dB		-18 -16	
S22	Output Return Loss, 50Ω load	3.5 GHz 5 GHz	dB		-16 -15	
S12	Reverse Isolation	3.5 GHz 5 GHz	dB		-21 -18	
OP1dB	Output Power at 1dB Gain Compression	3.5 GHz 5 GHz	dBm	22	22 23.8	–

### Notes:

1. Measurements obtained using demo board described in Figure 22 and 23. Both 3.5GHz and 5GHz data were taken with 3GHz - 6GHz Application Test Circuits.
2. OIP3 test condition: F<sub>RF1</sub> - F<sub>RF2</sub> = 10MHz with input power of -10dBm per tone measured at worse side band.
3. Use proper bias, heat sink and de-rating to ensure maximum channel temperature is not exceeded. See absolute maximum ratings and application note (if applicable) for more details.

## Typical Performance (2GHz - 4GHz)

$T_A = 25^\circ\text{C}$ ,  $V_{dd} = 5\text{V}$ , Input Signal = CW. Application Test Circuit is shown in Figure 22 and Table 1.

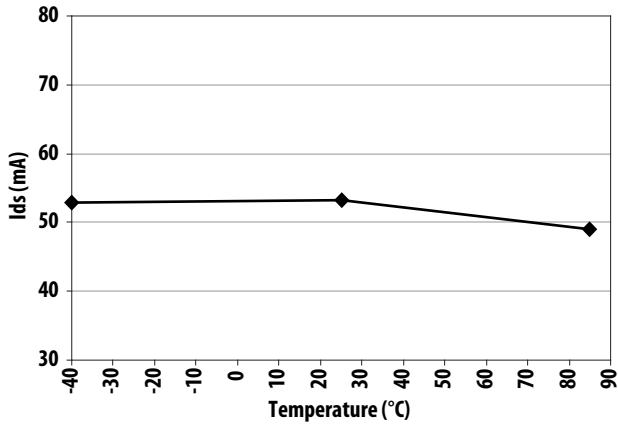

Figure 6. Ids over Temperature

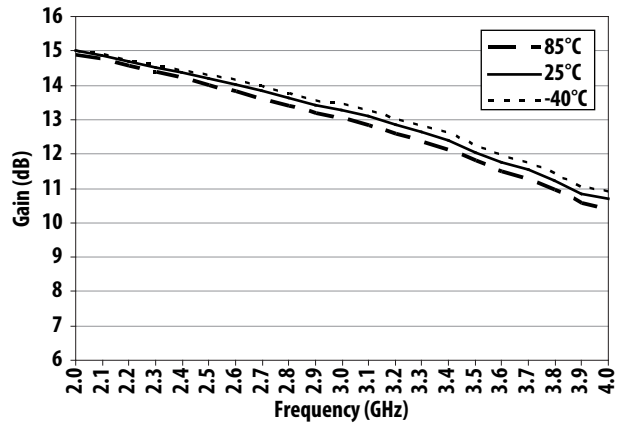

Figure 7. Gain over Frequency and Temperature

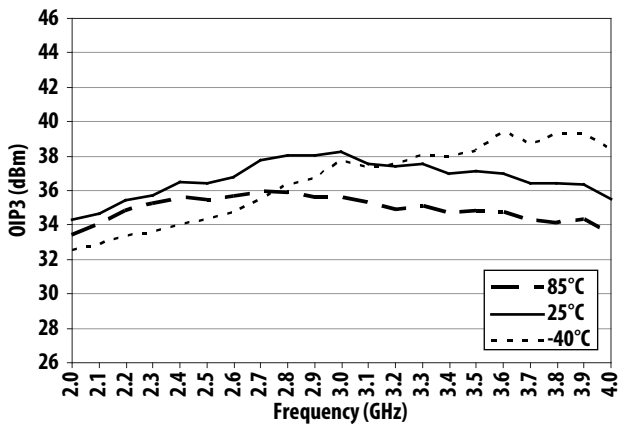

Figure 8. OIP3 over Frequency and Temperature

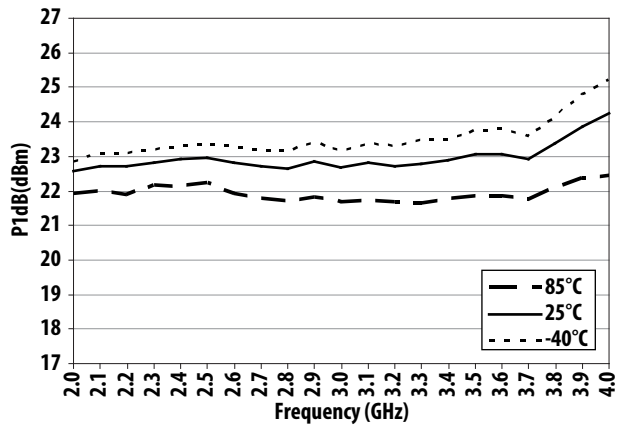

Figure 9. P1dB over Frequency and Temperature

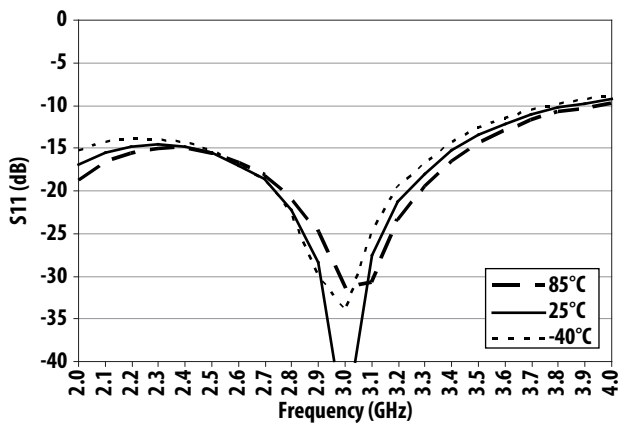

Figure 10. S11 over Frequency and Temperature

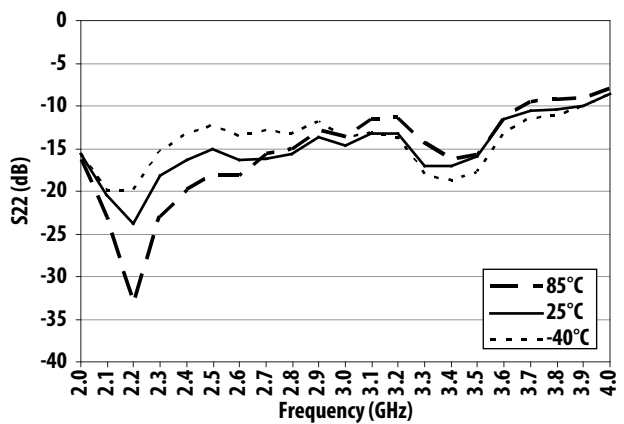

Figure 11. S22 over Frequency and Temperature

### Typical Performance (2GHz - 4GHz)

T<sub>A</sub> = 25°C, V<sub>dd</sub> = 5V, Input Signal = CW. Application Test Circuit is shown in Figure 22 and Table 1.

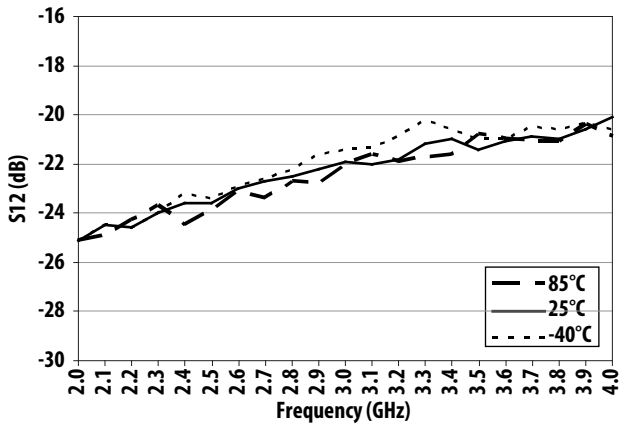

Figure 12. S12 over Frequency and Temperature

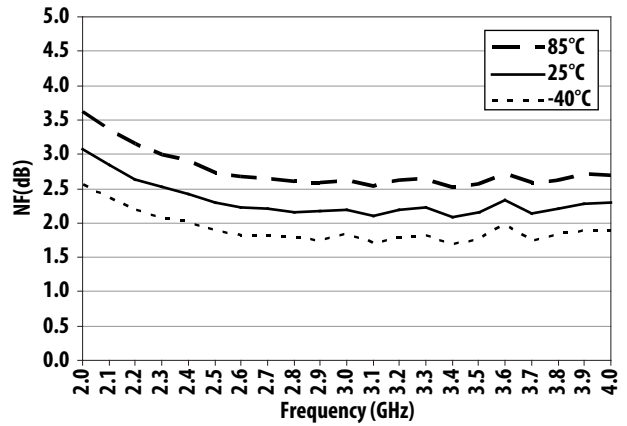

Figure 13. Noise Figure over Frequency and Temperature

### Typical Performance (3GHz - 6GHz)

T<sub>A</sub> = 25°C, V<sub>dd</sub> = 5V, Input Signal = CW. Application Test Circuit is shown in Figure 22 and Table 2.

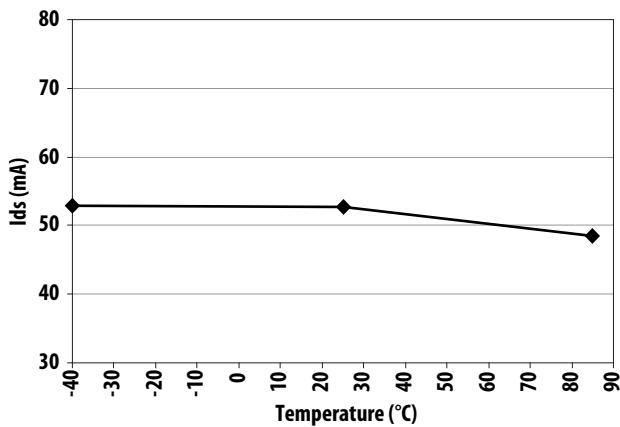

Figure 14. Ids over Temperature

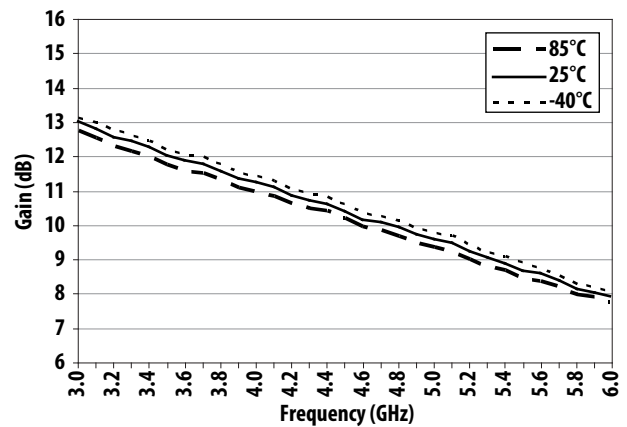

Figure 15. Gain over Frequency and Temperature

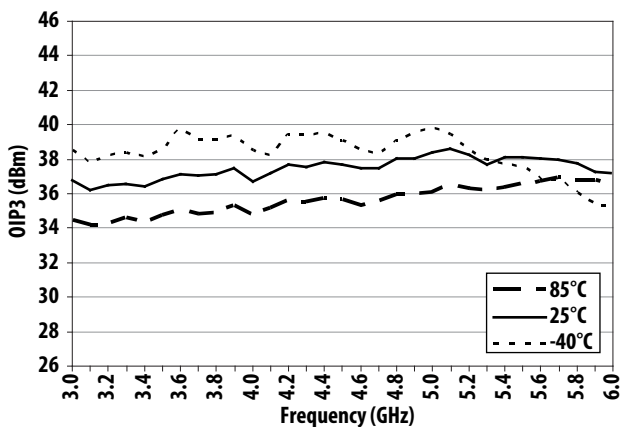

Figure 16. OIP3 over Frequency and Temperature

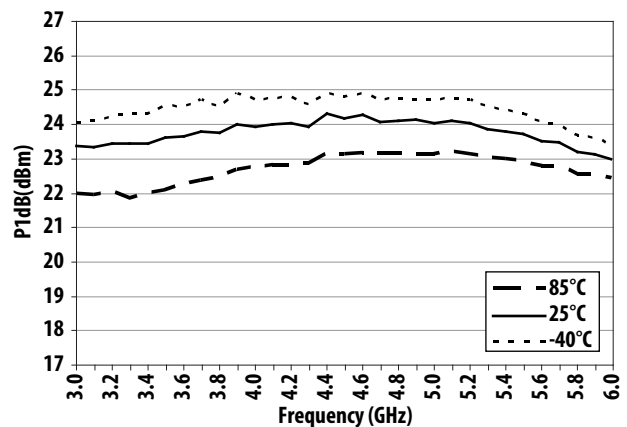

Figure 17. P1dB over Frequency and Temperature

## Typical Performance (3GHz - 6GHz)

$T_A = 25^\circ\text{C}$ ,  $V_{dd} = 5\text{V}$ , Input Signal = CW. Application Test Circuit is shown in Figure 22 and Table 2.

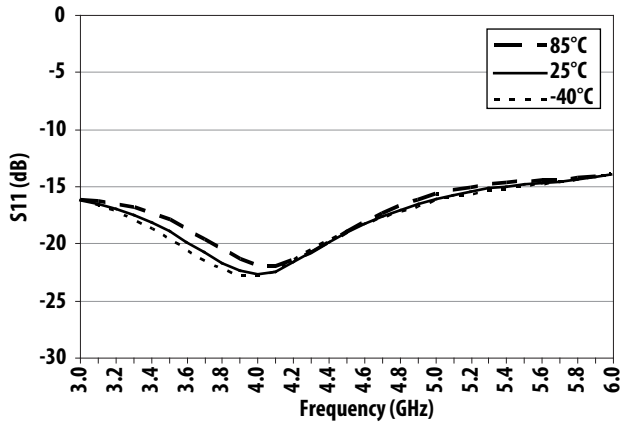

Figure 18. S11 over Frequency and Temperature

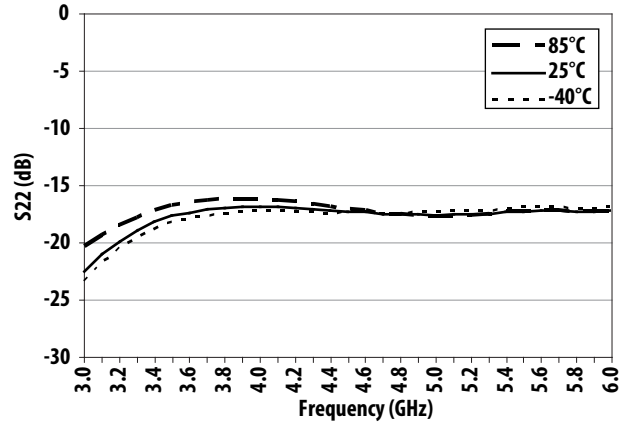

Figure 19. S22 over Frequency and Temperature

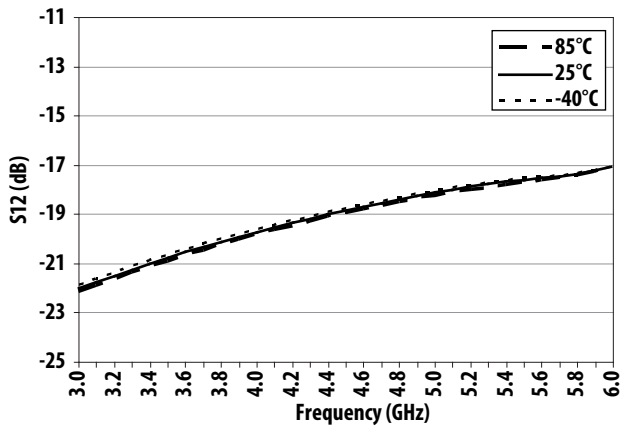

Figure 20. S12 over Frequency and Temperature

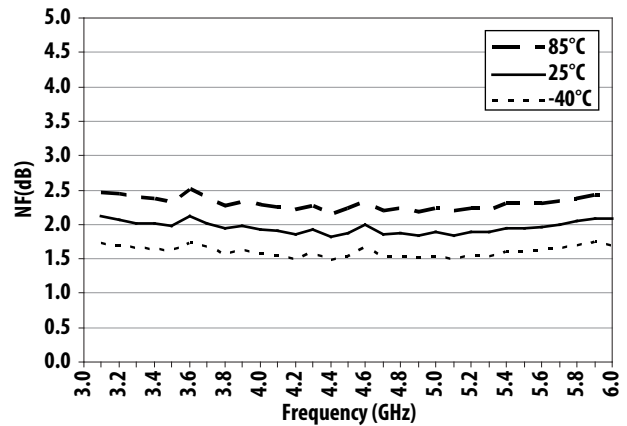

Figure 21. Noise Figure over Frequency and Temperature

## Application Schematic Components Table and Demo Board

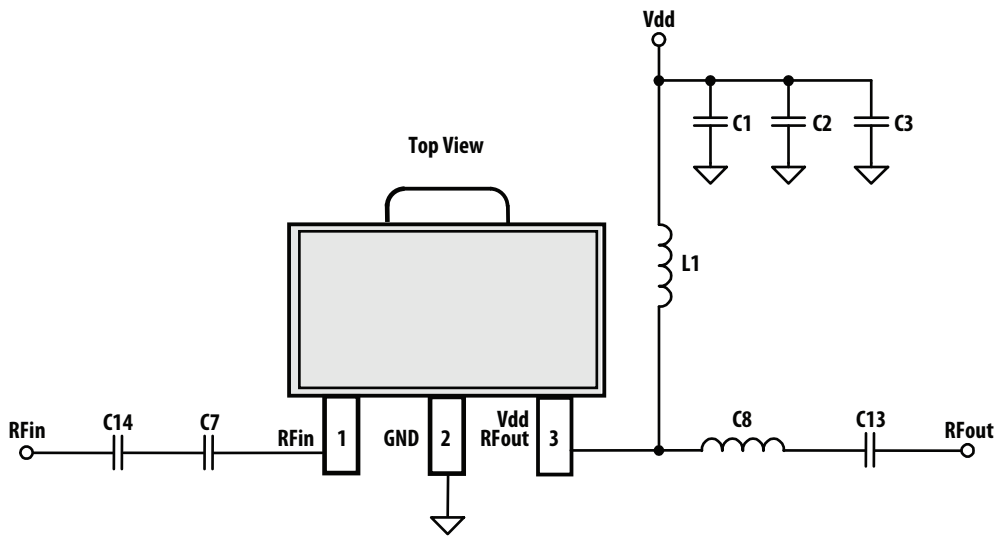

Figure 22. Application Schematic

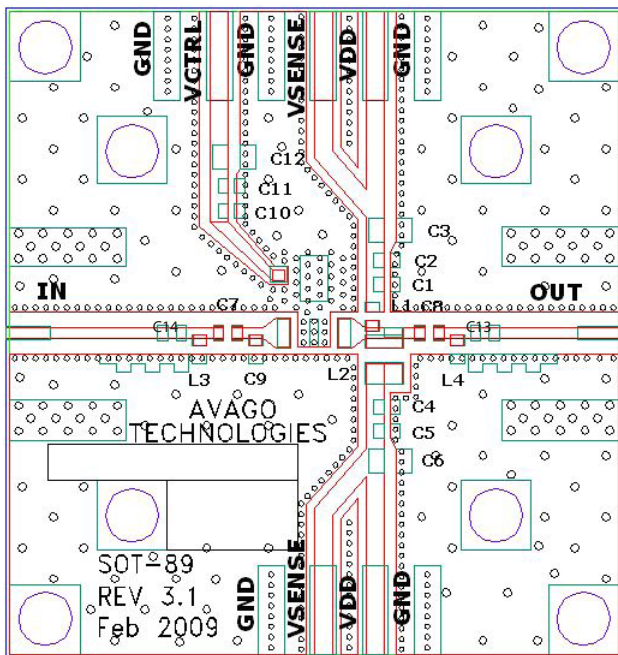

Figure 23. Demo board Layout

- Recommended PCB material is 10 mils Rogers RO4350, with FR4 backing for mechanical strength.
- Suggested component values may vary according to layout and PCB material.

## Demo board Part List

**Table 1. 2GHz - 4GHz Application Schematic Components**

Circuit Symbol	Size	Value	Part Number	Description
L1	0603	8.2nH	LLQ1608-F8N2 (Toko)	Wire Wound Chip Inductor
C1	0402	100pF	GRM1555C1H101JZ01 (Murata)	Ceramic Chip Capacitor
C2	0402	0.1uF	GRM155R71C104KA88D (Murata)	Ceramic Chip Capacitor
C3	0805	2.2uF	GRM21BR61E225KA12L (Murata)	Ceramic Chip Capacitor
C7	0402	1nH	LL1005-FHL1N0 (Toko)	MLC Inductor
C8	0402	1nH	LL1005-FHL1N0 (Toko)	MLC Inductor
C13	0402	39pF	CM05CH390J50AH (Kyocera)	Ceramic Chip Capacitor
C14	0402	39pF	CM05CH390J50AH (Kyocera)	Ceramic Chip Capacitor

**Table 2. 3GHz - 6GHz Application Schematic Components**

Circuit Symbol	Size	Value	Part Number	Description
L1	0603	8.2nH	LLQ1608-F8N2 (Toko)	Wire Wound Chip Inductor
C1	0402	100pF	GRM1555C1H101JZ01 (Murata)	Ceramic Chip Capacitor
C2	0402	0.1uF	GRM155R71C104KA88D (Murata)	Ceramic Chip Capacitor
C3	0805	2.2uF	GRM21BR61E225KA12L (Murata)	Ceramic Chip Capacitor
C7	0402	39pF	CM05CH390J50AH (Kyocera)	Ceramic Chip Capacitor
C8	0402	39pF	CM05CH390J50AH (Kyocera)	Ceramic Chip Capacitor
C13			NA	
C14			NA	

## Test Circuit for S-Parameter and Noise Parameter

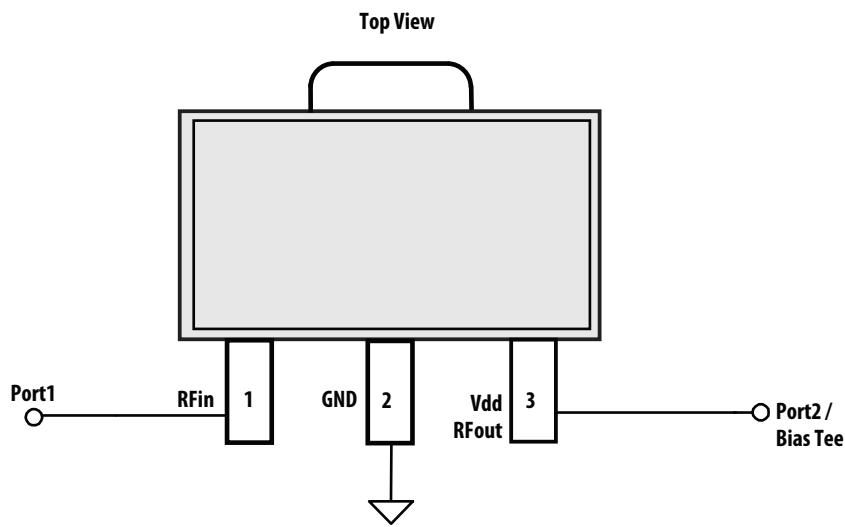

**Figure 24. S-parameter and Noise parameter test circuit**



**Typical S-Parameter (Vdd = 5V, TA = 25°C, 50 ohm)**

Freq (GHz)	S11 (dB)	S11 (ang)	S21 (dB)	S21 (ang)	S12 (dB)	S12 (ang)	S22 (dB)	S22 (ang)
0.1	-0.83	171.33	-49.08	107.91	-70.09	11.18	-11.42	156.15
0.5	-0.85	133.94	-29.47	73.45	-72.22	8.53	-9.79	54.38
1	-1.73	69.70	-7.88	124.85	-51.74	42.20	-7.59	-28.70
1.5	-18.64	13.90	14.19	-16.36	-28.40	-110.19	-13.30	-84.47
2	-16.77	21.81	15.26	-118.45	-24.68	162.38	-16.46	-119.30
2.2	-17.69	26.98	15.08	-146.17	-23.80	140.85	-20.71	-136.97
2.4	-17.47	27.84	14.78	-169.72	-23.09	123.10	-27.25	-147.15
2.6	-17.54	21.54	14.41	169.77	-22.45	107.84	-36.62	-119.61
2.8	-18.71	9.75	14.06	151.46	-21.86	94.47	-33.44	-73.79
3	-21.50	-7.64	13.71	134.78	-21.30	82.34	-29.50	-90.05
3.2	-26.62	-45.95	13.35	119.28	-20.77	71.05	-26.66	-116.49
3.4	-25.94	-124.50	12.98	104.86	-20.30	60.36	-23.92	-140.25
3.6	-20.44	-160.65	12.60	91.24	-19.87	50.23	-21.74	-159.02
3.8	-16.93	-177.59	12.21	78.46	-19.49	40.73	-20.32	-173.92
4	-14.77	170.22	11.82	66.38	-19.14	31.67	-19.31	175.19
4.2	-13.39	160.76	11.45	54.96	-18.81	23.05	-19.03	166.34
4.4	-12.66	151.96	11.09	43.99	-18.49	14.81	-19.23	160.06
4.6	-12.37	142.32	10.78	33.45	-18.16	6.72	-19.80	154.58
4.8	-12.28	131.95	10.50	23.16	-17.82	-1.24	-20.57	150.45
5	-12.32	119.49	10.23	12.97	-17.50	-9.24	-21.46	145.29
5.2	-11.90	102.53	9.97	2.27	-17.18	-17.80	-24.67	123.26
5.4	-11.51	86.82	9.69	-7.74	-16.90	-25.83	-23.37	106.21
5.6	-10.94	70.38	9.40	-17.72	-16.65	-33.97	-21.51	91.68
5.8	-10.14	53.71	9.10	-27.77	-16.45	-42.22	-19.44	79.92
6	-9.13	38.09	8.75	-37.67	-16.30	-50.47	-17.49	69.67
6.2	-8.04	24.75	8.37	-47.47	-16.21	-58.70	-15.67	59.26
6.4	-6.95	13.52	7.95	-57.15	-16.17	-66.81	-13.97	48.91
6.6	-5.97	4.20	7.50	-66.64	-16.19	-74.66	-12.52	38.89
6.8	-5.14	-2.97	7.00	-75.60	-16.24	-82.14	-11.26	28.93
7	-4.46	-8.67	6.51	-83.99	-16.31	-89.21	-10.27	19.35
8	-2.90	-25.68	4.58	-121.23	-16.31	-120.23	-7.84	-28.28
9	-2.46	-52.31	2.99	-158.46	-16.20	-152.20	-6.19	-69.12
10	-1.73	-90.52	0.67	164.95	-16.99	175.54	-4.64	-97.97
11	-0.89	-118.15	-2.55	136.43	-18.81	150.58	-3.14	-118.40
12	-0.61	-129.25	-5.00	117.68	-19.97	134.70	-2.55	-131.60
13	-0.76	-143.32	-6.00	96.90	-19.81	116.35	-2.38	-146.90
14	-1.01	-166.19	-6.20	70.58	-18.85	92.19	-2.68	-168.13
15	-0.88	168.37	-7.47	41.66	-19.03	65.52	-2.36	162.57
16	-0.85	157.29	-8.58	25.78	-18.91	51.09	-2.07	153.40
17	-1.18	147.97	-8.14	9.21	-17.33	35.32	-2.29	140.45
18	-1.83	133.03	-7.18	-10.20	-15.36	16.25	-2.52	133.73
19	-3.05	112.54	-5.32	-38.11	-12.58	-11.48	-4.28	116.79
20	-4.26	92.05	-4.57	-70.41	-10.96	-43.88	-5.03	93.24

**Typical Noise Parameters (Vdd = 5V, T<sub>A</sub> = 25°C, 50 ohm)**

Freq (GHz)	F <sub>min</sub> (dB)	Γ <sub>opt</sub> Mag	Γ <sub>opt</sub> Ang	R <sub>n</sub> /Z <sub>0</sub>
2.0	2.95	0.086	49	0.52
2.5	2.32	0.12	90	0.29
3.0	1.83	0.15	122	0.19
3.5	1.54	0.18	174	0.18
4.0	1.53	0.22	-145	0.17
4.5	1.61	0.24	-103	0.21
5.0	1.78	0.27	-62	0.22
5.5	2.05	0.30	-35	0.32
6.0	2.22	0.33	-7.8	0.37

**Part Number Ordering Information**

Part Number	No. of Devices	Container
MGA-30989-BLKG	100	Antistatic Bag
MGA-30989-TR1G	3000	13" Tape/Reel

# SOT89 Package Dimensions

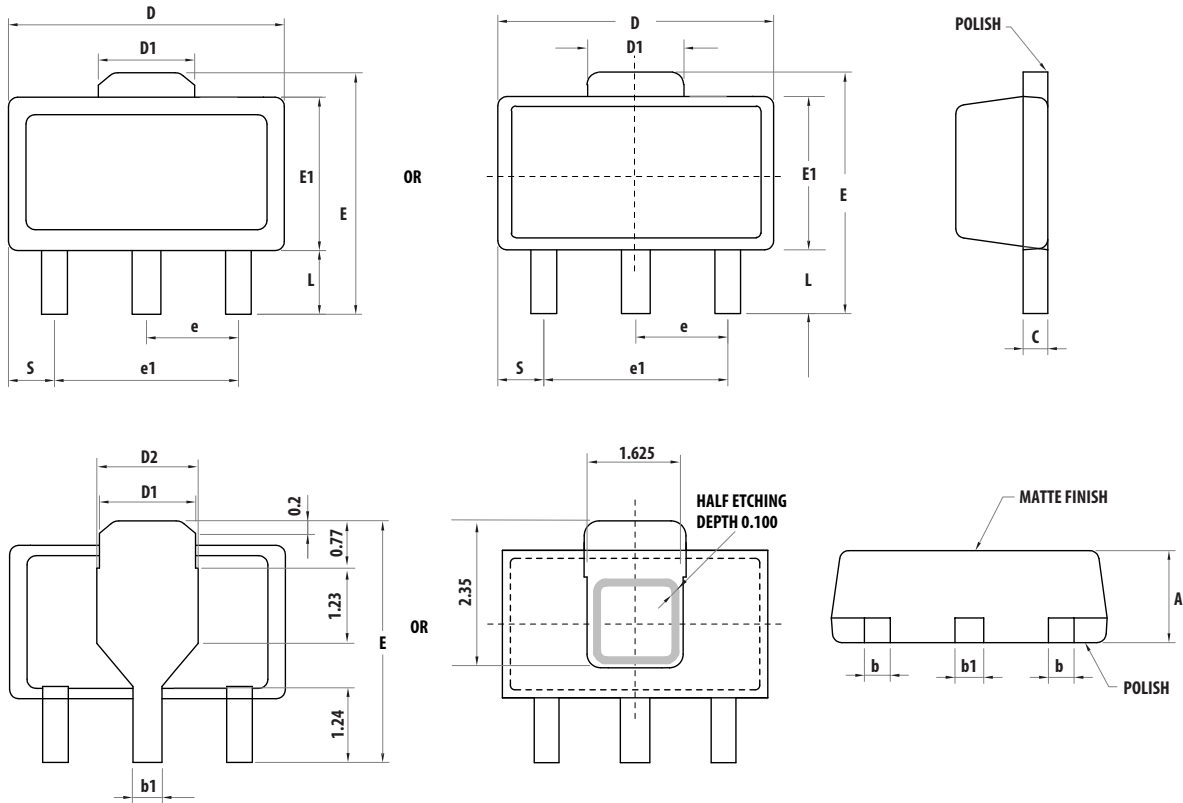

Symbols	Dimensions in mm			Dimensions in inches		
	Minimum	Nominal	Maximum	Minimum	Nominal	Maximum
A	1.40	1.50	1.60	0.055	0.059	0.063
L	0.89	1.04	1.20	0.0350	0.041	0.047
b	0.36	0.42	0.48	0.014	0.016	0.018
b1	0.41	0.47	0.53	0.016	0.018	0.030
C	0.38	0.40	0.43	0.014	0.015	0.017
D	4.40	4.50	4.60	0.173	0.177	0.181
D1	1.40	1.60	1.75	0.055	0.062	0.069
D2	1.45	1.65	1.80	0.055	0.062	0.069
E	3.94	-	4.25	0.155	-	0.167
E1	2.40	2.50	2.60	0.094	0.098	0.102
e1	2.90	3.00	3.10	0.114	0.118	0.122
S	0.65	0.75	0.85	0.026	0.030	0.034
e	1.40	1.50	1.60	0.054	0.059	0.063

## Device Orientation

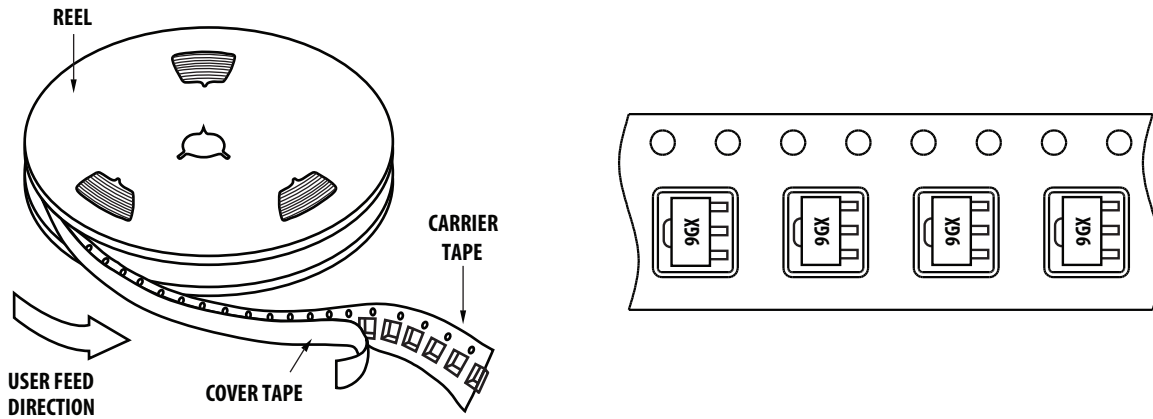

## Tape Dimensions

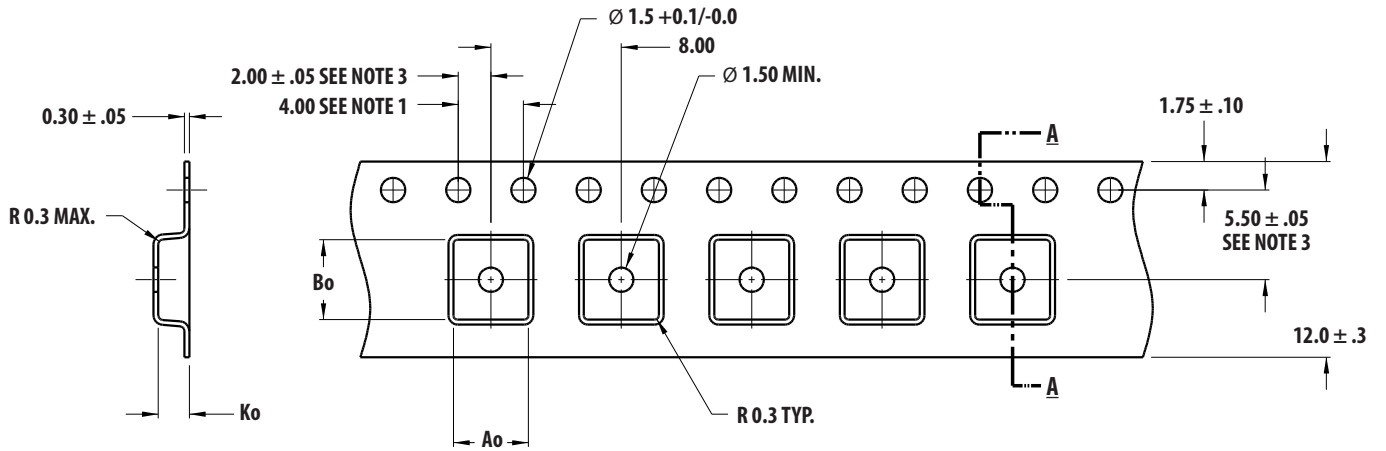

### SECTION A - A

Ao = 4.60  
Bo = 4.90  
Ko = 1.90

### DIMENSIONS IN MM

#### NOTES:

1. 10 SPROCKET HOLE PITCH CUMULATIVE TOLERANCE  $\pm 0.2$
2. CAMBER IN COMPLIANCE WITH EIA 481
3. POCKET POSITION RELATIVE TO SPROCKET HOLE MEASURED AS TRUE POSITION OF POCKET, NOT POCKET HOLE

# Reel Dimensions – 13" Reel

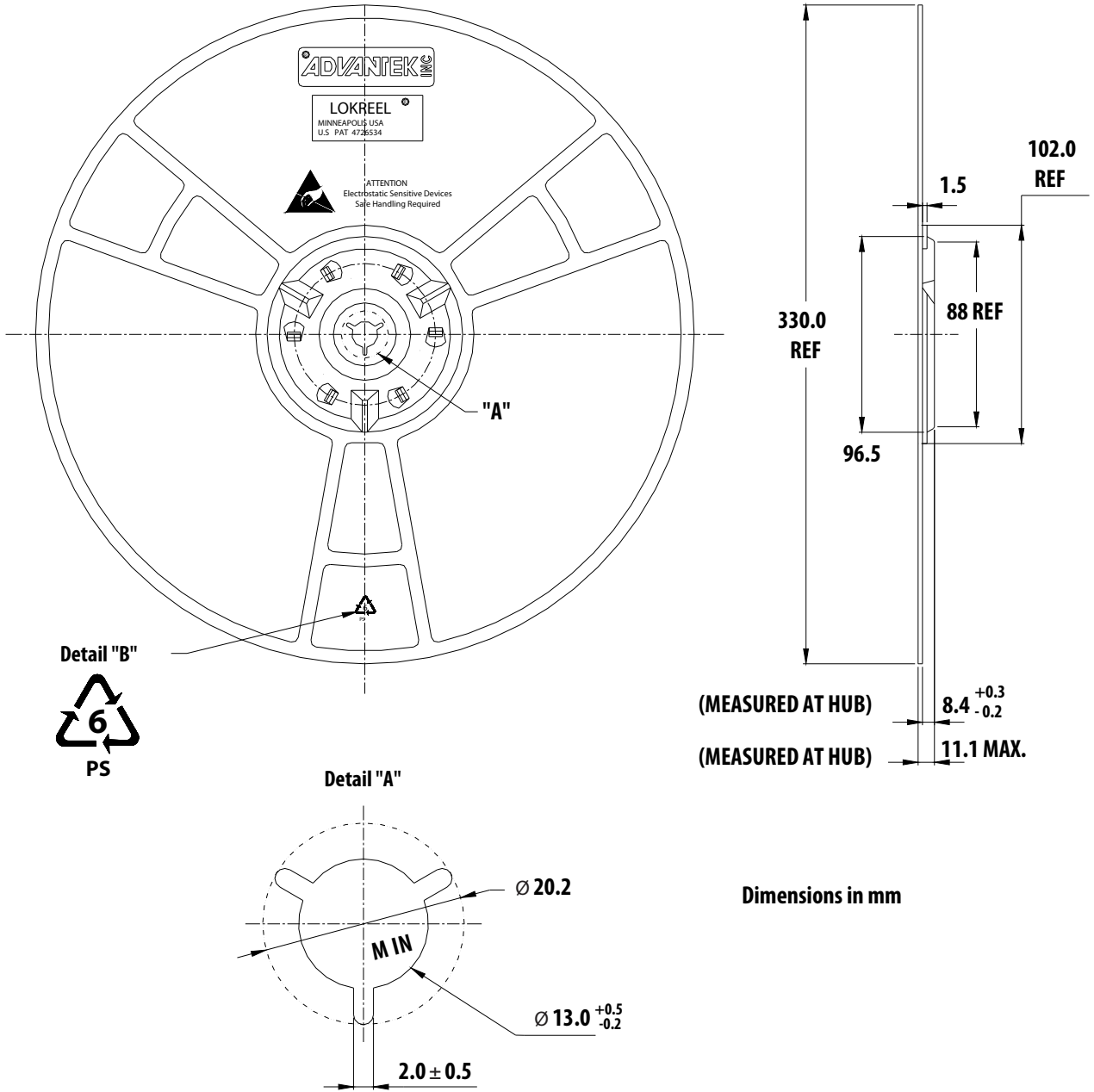

Dimensions in mm

For product information and a complete list of distributors, please go to our web site: [www.avagotech.com](http://www.avagotech.com)

Avago, Avago Technologies, and the A logo are trademarks of Avago Technologies in the United States and other countries. Data subject to change. Copyright © 2005-2013 Avago Technologies. All rights reserved. AV02-2251EN - May 23, 2013

