

YM2N/24D5P(Z)22模块—— 5A 700V SSR module

概述 Features

- 调相型 Non zero-cross
- 负载电流至5A Load current up to 5A
- 阻断电压700V Repetitive peak off-state voltage 700V
- 介质耐压2500V Dielectric strength 2500V
- 带工作状态显示 Operating display
- 带导轨快连接安装 Rail fast mount
- 快连接接线端子 Quick-connect terminal

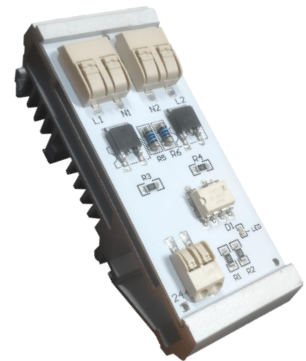

应用 Applications

- 工业控制 Industrial control

打印标志 Marking information

Part number	Package	Marking
YM2N/24D5P22	导轨快速安装	24D5P22
YM2N/24D5Z22	导轨快速安装	24D5Z22

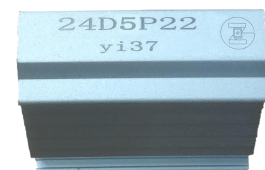
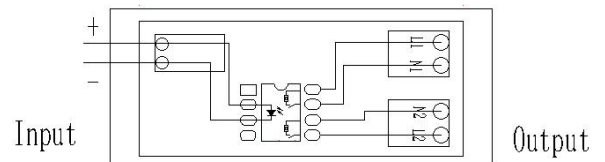

极限值 Absolute maximum ratings (单个SSR)

(Ta=25°C)

特性参数/Parameter		符号/Symbol	测试条件/Test condition	最小值/Min.	典型值/Typ.	最大值/Max.	单位/Unit
输入端/Input	工作电压/Operating voltage	V_{in}		19	24	28.8	V
输出端/Output	阻断电压/Repetitive peak off-state voltage	V_{DRM}/V_{RRM}		700			V
	额定电流/On-state RMS current	$I_{T(RMS)}$	$V_{in}=24V$			5	A
	浪涌电流/Surge current	I_{TSM}	50Hz, 1 cycle		25		A
介质耐压/I/O Dielectric strength *		V_{ISO}	$I_{ISO} \leq 0.3mA$	2500			V_{rms}
工作温度/Operating temperature		T_{opr}		-30		85	°C
储存温度/Storage temperature		T_{stg}		-40		125	°C

“*”：RH=40 to 60%, T=20~30°C, AC for 1minute.

电参数 Electrical parameters (单个SSR)

(Ta=25°C)

特性参数/Parameter		符号/Symbol	测试条件/Test condition	最小值/Min.	典型值/Typ.	最大值/Max.	单位/Unit
输入端/Input	输入电流/Input current	I_{in}	$V_{in}=V_{in}+20\%$		14	18	mA
输出端/Output	断态泄漏电流/Output off-state leakage current	I_{DRM}	$V_{DRM}=700V$			10	μA
	断态泄漏电流/Output off-state leakage current	I_{RRM}	$V_{RRM}=700V$			10	μA
耦合特性/Transfer characteristics	接通电压/Turn on voltage	V_{on}			8	18	V
	关断电压/Must release voltage	V_{off}		1.2			V
	导通电压降/Output on-state voltage drop	V_T	$V_{in}=24V, I_1=2A$		1.2	1.4	V
	过零电压/Zero-cross voltage (仅对过零型)	V_{zc}			15	30	V
	导通时间/Turn on time	T_{on}	$V_{in}=24V, I_1=600mA$			1	ms
	关断时间/Turn off time	T_{off}	$V_{in}=24V, I_1=600mA$			1+1/2cycle	ms

外形尺寸 Outline dimension :mm

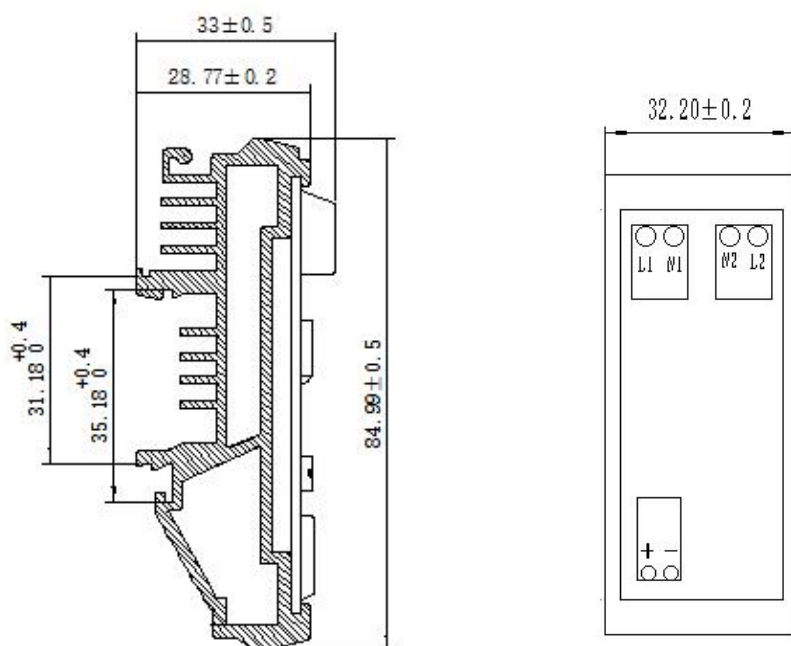

订货信息 Ordering information

订货信息/Ordering information							
	Y	M	2N	24D	5	P	22
公司商标代号 Company symbol							
交流输出型 SSR 模组 AC SSR Output module							
控制电路数 Number of control circuits 2: 2 组							
输入电压 Input voltage: 24Vdc							
负载电流 Load current: 5-5A							
P: 调相型 Non zero-cross Z: 过零型 Zero-cross							
负载电压 Load voltage: 22-220Vac							

特性曲线 Characteristic data

1. 负载电流与环境温度关系曲线

Load current VS. ambient temperature

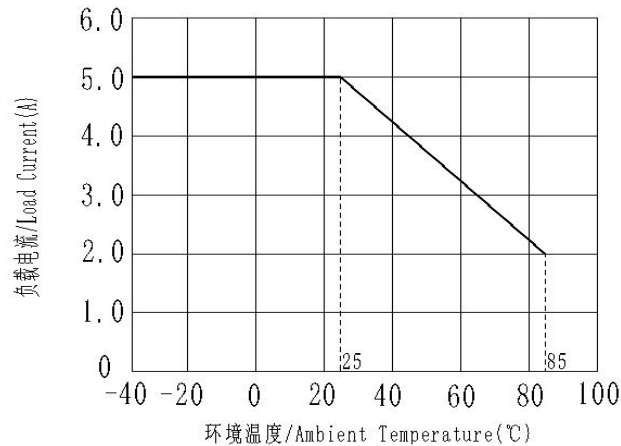

接通和关断时间关系 Turn on and turn off time

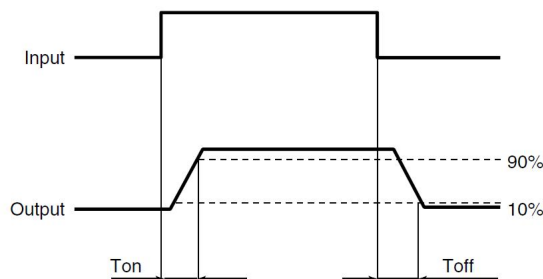

接线图 Wiring diagram

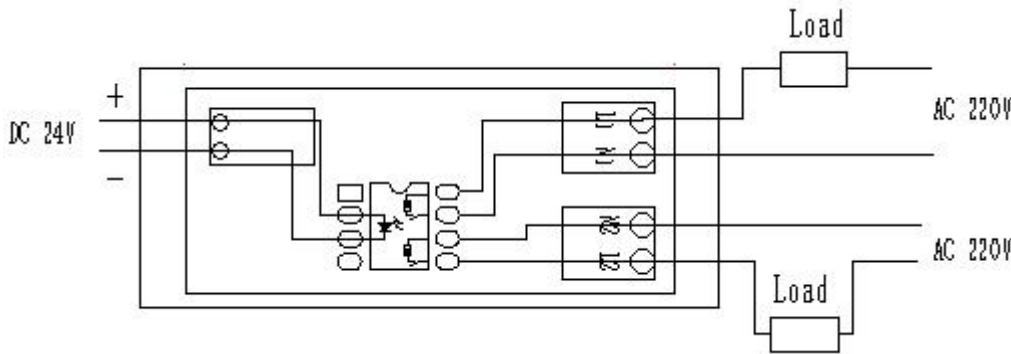

注意事项 Notes

a) 工作环境温度超过 25℃时请降额使用。参见特性曲线。

When ambient temperature is above 25℃, the load current must be reduced. (see characteristic data)

b) 继电器接线时，务必保证输入端极性的正确，以免损坏继电器。

Ensuring the polarity is correct when connecting the input lines, otherwise the wrong connection will damage the relay.

关于防静电对策 Cautions for static electricity

a. 操作 MOS 输出继电器的作业人员，请穿戴防静电工作服，通过 500kΩ~1MΩ 左右的保护电阻，实施人体接地。

a. Employees handling relays should wear anti-static clothes and should be grounded through protective resistance of 500kΩ to 1MΩ.

b. 请在作业台上装有带导电性的金属板或具有防静电的专用板，并对测量仪器和治具等实施接地。

b. A conductive metal sheet should be placed over the work table. Measuring instruments and jigs should be grounded.

c. 组装时使用的设备等也应正确地接地。

c. Devices and equipment used in assembly should also be grounded.

d. 对印刷电路板和机器进行包装时，请避免使用发泡苯乙烯、聚乙烯等带电性的高分子材料。

d. When packing printed circuit boards and equipment, avoid using high-polymer materials such as foam styrene, plastic, and other materials which carry an electrostatic charge.

e. 对 MOS 输出继电器进行储存和搬运时，请在不易产生静电的环境(例如湿度 45~60%)中通过导电性包装材料进行保护。

e. When storing or transporting relays, the environment should not be conducive to generating static electricity (for instance, the humidity should be between 45 and 60%), and relays should be protected using conductive packing materials.