

DUAL OPERATIONAL AMPLIFIER

DESCRIPTION

The LM358 consists of two independent high gain, internally frequency compensated operational amplifier. It can be operated from a single power supply and also split power supplies.

FEATURES

- *Internally frequency compensated for unity gain.
- *Wide power supply range 3V - 32V.
- *Input common-mode voltage range include ground.
- *Large DC voltage gain.

APPLICATIONS

- *General purpose amplifier.
- *Transducer amplifier.

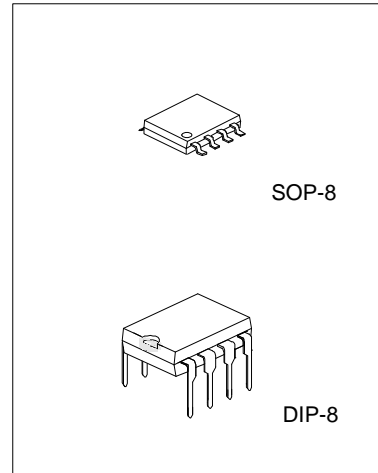

PIN CONFIGURATIONS

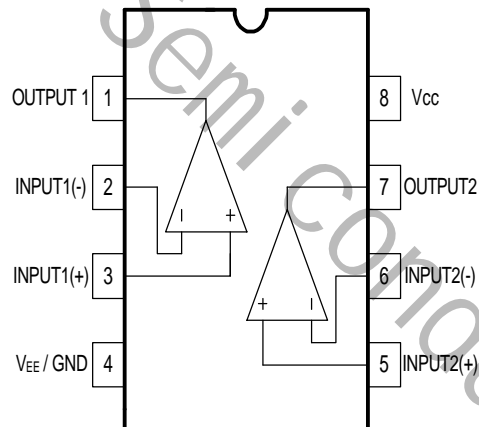

BLOCK DIAGRAM

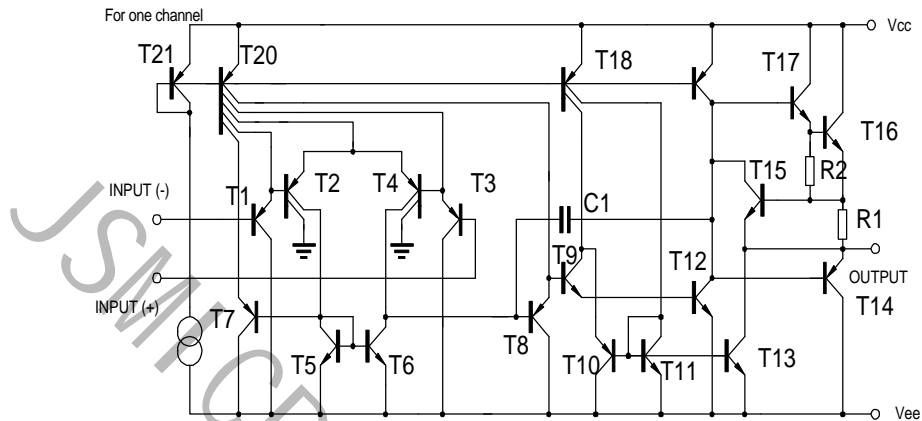

ABSOLUTE MAXIMUM RATINGS

PARAMETER	SYMBOL	VALUE	UNIT
Supply Voltage	V_{cc}	+16 or 32	V
Differential Input Voltage	$V_I(\text{DIFF})$	32	V
Input Voltage	V_I	-0.3 ~ +32	V
Output Short to Ground		Continuous	
Operating Temperature Range	TOPR	0 ~ +70	°C
Storage Temperature Range	TSTG	-65 ~ +150	°C

ELECTRICAL CHARACTERISTICS ($V_{CC}=5.0V, V_{EE}=GND, T_A=25^{\circ}C$, unless otherwise specified) ©

PARAMETER	SYMBOL	TEST CONDITION	MIN	TYP	MAX	UNIT
Input Offset Voltage	VIO	$V_{CM}=0V$ to $V_{CC}-1.5V$ $V_{O(P)}=1.4V, R_S=0\Omega$		2.9	7.0	mV
Input Offset Current	IIO			5	50	nA
Input Bias Current	IBIAS			45	250	nA
Input Common Mode Voltage	VI(R)	$V_{CC}=30V$	0		$V_{CC}-1.5$	V
Power Supply Current	ICC	$R_L=\infty, V_{CC}=30V$		0.8	2.0	mA
		$R_L=\infty$, Full Temperature Range		0.5	1.2	mA
Large Signal Voltage Gain	GV	$V_{CC}=15V, R_L \geq 2K\Omega$ $V_{O(P)}=1V$ to $11V$	25	100		V/mV
Output Voltage Swing	VO(H)	$V_{CC}=30V, R_L=2K\Omega$	26			V
		$V_{CC}=30V, R_L=10K\Omega$	27	28		V
	VO(L)	$V_{CC}=5V, R_L \geq 10K\Omega$		5	20	mV
Common Mode Rejection Ratio	CMRR		65	80		dB
Power Supply Rejection Ratio	PSRR		65	100		dB
Channel Separation	CS	$f=1KHZ$ to $20KHZ$		120		dB
Short Circuit Current to Ground	ISC			40	60	mA
Output Current	ISOURCE	$V_I(+)=1V, V_I(-)=0V$ $V_{CC}=15V, V_{O(P)}=2V$	20	30		mA
	ISINK	$V_I(+)=0V, V_I(-)=1V$ $V_{CC}=15V, V_{O(P)}=2V$	10	15		mA
		$V_I(+)=0V, V_I(-)=1V$ $V_{CC}=15V, V_{O(P)}=200mV$	12	100		mA
Differential Input Voltage	VI(DIFF)				V_{CC}	V

TYPICAL PERFORMANCE CHARACTERISTICS

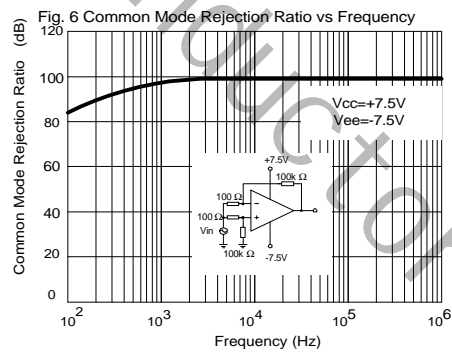
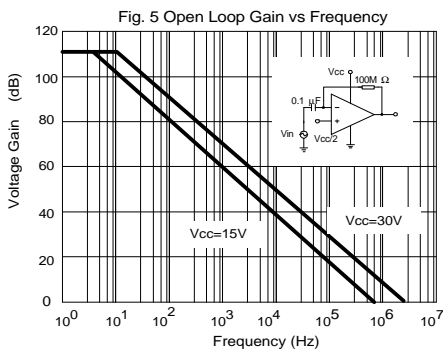
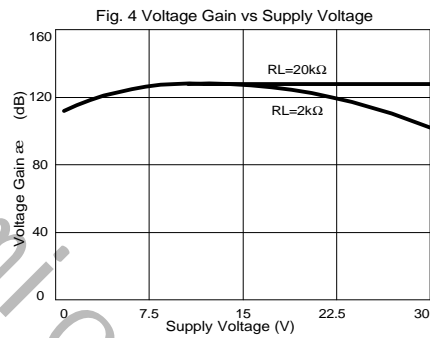
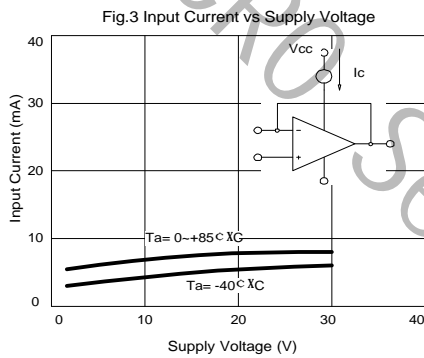
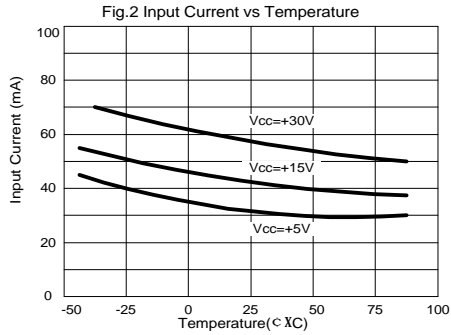
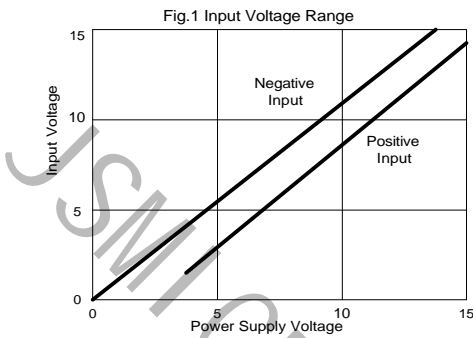

Fig. 7 Voltage Follower Pulse Response

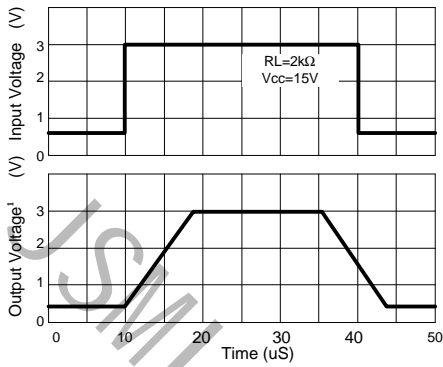

Fig. 8 Voltage Follower Response (Small Signal)

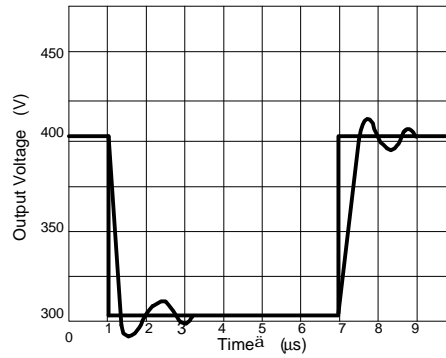

Fig. 9 Gain vs Large Signal Frequency

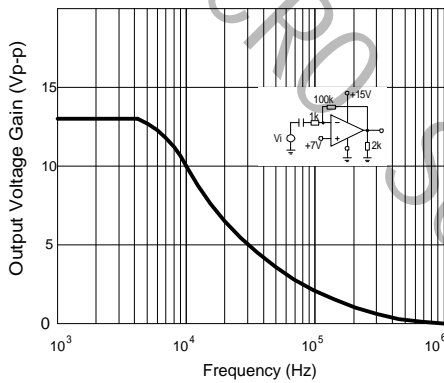

Fig. 10 Output Current Sinking vs Output Voltage

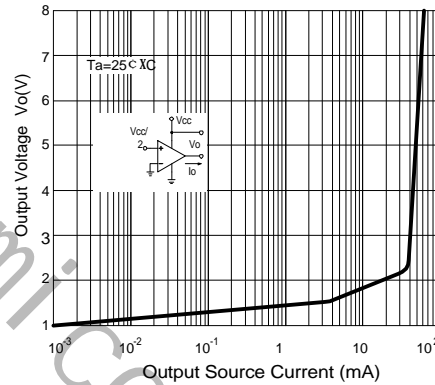

Fig. 11 Output Sink Current vs Output Voltage

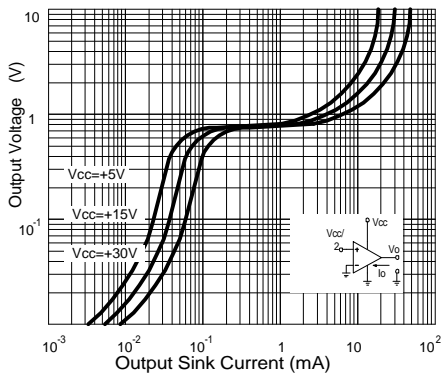

Fig. 12 Current Limiting vs Temperature

