

描述 / Descriptions

SOT-23 塑封封装 N 沟道 MOS 场效应管。
 N- CHANNEL MOSFET in a SOT-23 Plastic Package.

特征 / Features

芯片采用超高密度圆胞设计技术， $R_{DS(ON)}$ 导通电阻小，SOT-23 封装。
 Super high dense cell design for low $R_{DS(ON)}$, SOT-23 package.

用途 / Applications

电池管理，高速开关，低功率 DC-DC 转换。
 Battery management, High speed switch, low power DC to DC converter.

印章代码 / Marking

Marking	A2SHB
---------	-------

极限参数 / Absolute Maximum Ratings(Ta=25°C)

参数 Parameter	符号 Symbol	数值 Rating	单位 Unit
Drain-Source Voltage	V_{DSS}	20	V
Gate-Source Voltage	V_{GSS}	±8	V
Drain Current – Continuous	I_D	3.0	A
Pulsed Drain Current	I_{DM}	10	A
Continuous Source Current	I_S	0.95	A
Power Dissipation	P_D	0.9	W
Storage Temperature Range	T_{stg}	-55~150	°C



PIN1 : G

PIN 2 : S

PIN 3 : D



电性能参数 / Electrical Characteristics(Ta=25°C)

参数 Parameter	符号 Symbol	测试条件 Test Conditions		最小值 Min	典型值 Typ	最大值 Max	单位 Unit
Drain-Source Breakdown Voltage	$V_{(BR)DSS}$	$V_{GS}=0$	$I_D=10\mu A$	20			V
Zero Gate Voltage Drain Current	I_{DSS}	$V_{GS}=0$	$V_{DS}=20V$			1.0	μA
Gate-Body Leakage.	I_{GSS}	$V_{GS}=\pm 8V$	$V_{DS}=0V$			± 100	nA
Static Drain-Source On-Resistance	$R_{DS(on)1}$	$V_{GS}=4.5V$	$I_D=3.6A$			60	m Ω
	$R_{DS(on)2}$	$V_{GS}=2.5V$	$I_D=3.1A$			115	m Ω
Forward Transconductance	g_{FS}	$V_{DS}=5V$	$I_D=3.6A$		8		S
Drain-Source Diode Forward Voltage	V_{SD}	$V_{GS}=0V$	$I_D=1.25A$		0.75	1.2	V
Gate Threshold Voltage	$V_{GS(th)}$	$V_{DS}=V_{GS}$	$I_D=50\mu A$	0.50		1.0	V
State Drain Current	$I_{D(on)}$	$V_{DS}=5V$	$V_{GS}=2.5V$	4			A
Turn-On Delay Time	$t_{d(on)}$	$V_{DD}=10V$ $V_{GEN}=4.5V$ $R_{GEN}=6\Omega$ $R_L=2.8\Omega$	$I_D=3.6A$		7		ns
Turn-On Rise Time	t_r				55		
Turn-Off Delay Time	$t_{d(off)}$				15		
Turn-Off Fall Time	t_f				10		

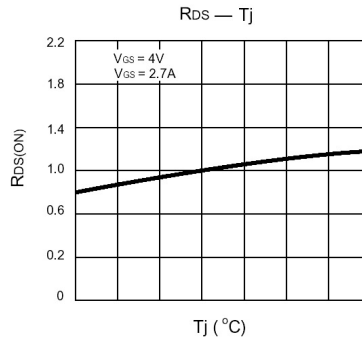
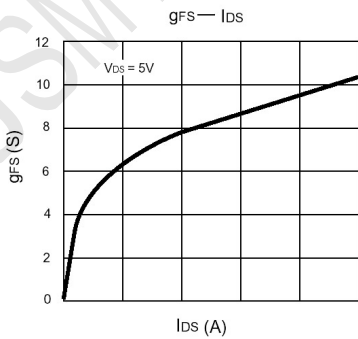
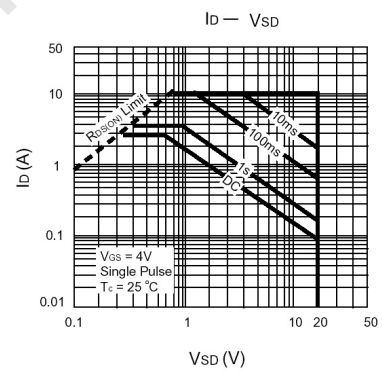
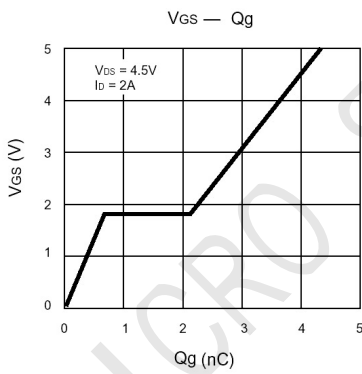
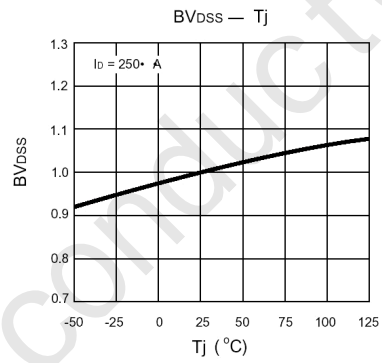
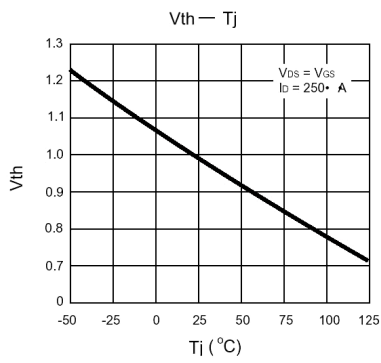
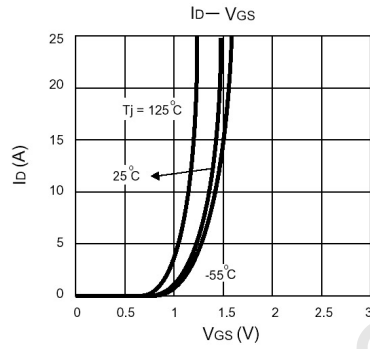
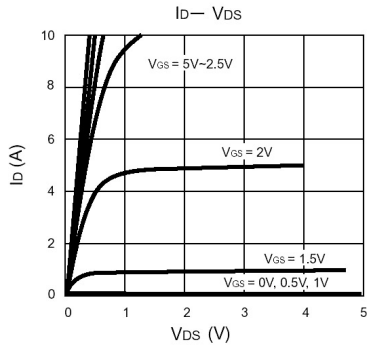
电参数曲线图 / Electrical Characteristic Curve

外形尺寸图 / Package Dimensions
SOT-23

单位; mm

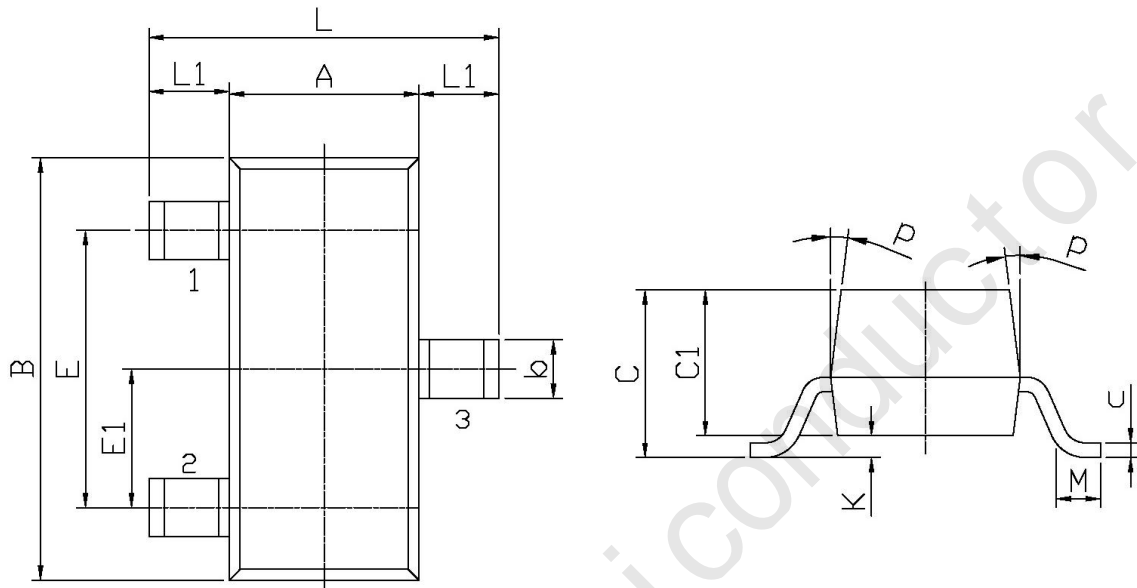

Symbol	Dimensions In Millimeters		Symbol	Dimensions In Millimeters	
	Min	Max		Min	Max
L	2.2	2.7	C	1.30Max	
L1	0.45	0.65	C1	0.90	1.20
A	1.15	1.50	c	0.05	0.20
B	2.70	3.10	K	0	0.10
E	1.70	2.10	M	0.20MIN	
E1	0.85	1.05	P	7°	
b	0.35	0.55			