

## 产品概观

WZ系列为全新世代高性价比的语音芯片,具有 9bits 高性能 PWM/DAC 语音引擎。并且具备有 5~80 秒(6K/4bits)多样化的型号选择,并内置有高精度起振器,毋需外部起振组件,外接组件少,让应用开发整体成本具有市场领先的优势。

## 功能概观

.语音引擎: 9bits PWM. / 9bits DAC(部分型号无 DAC 功能)

可编辑阶数: 3800 阶

可编辑群组数: 63 组(最大)

开机执行群组: 1 组

可放声音长度: 5(WZ005)/ 10(WZ010)/ 20(WZ020) / 40(WZ040)/ 80(WZ080)/  
4bits@6K-Playrate

四组可设定接口

- TG1 带序列模式一般输入接口。
- TG2 可设定为低准位触发复位接口。
- TG2 带序列模式一般输入接口。
- TG3 一般接口,可程序化为音量调整接口(部分型号)
- TG4 一般接口(部分型号)

.可程序化接口触发型态

- Re-triggered / Irre-triggered.
- Level / Edge.
- Hold / Un-hold.
- Voice Repeat / One-time voice.
- On/Off function.

.选表式声音压缩编码引擎

- 4bits / 5bits / 8bits / 9bits

内置单片机触发模式 SPI 接口

内置 RC 震荡起振回路,无须外部电路

宽工作电压: 2.0~5.0V

工作温度: -20°C ~ 60°C (不计工作频率飘移)

---

#### .简易编程功能

- 工作寄存器写入
- 工作寄存器进位
- 工作寄存器比较分支

#### .可程序化输出状态

- 待机准位
- 工作高准位
- 工作低准位
- 输出频闪

#### .多样化播放速率选择

- 3.1K / 3.2K / 3.3K / 3.5K / 3.7K / 3.8K
- 4.0K / 4.2K / 4.4K / 4.6K / 4.8K
- 5.0K / 5.3K / 5.6K
- 6.0K / 6.4K / 6.8K
- 7.4K / 8.0K / 8.7K / 9.6K / 10.6K / 12.0K
- 13.7K / 16.0K / 19.2K / 24.0K / 32.0K

## Body overview 母体比较表

Body / 母体	Duration/预估秒数	IO counts / 接口数
WZ005	5" @6K/4bits	2
WZ010	10" @6K/4bits	2
WZ020	20" @6K/4bits	2
WZ040	40" @6K/4bits	4
WZ080	80" @6K/4bits	4

## 封装脚位图

WZ020 / WZ010 / WZ005 SOP8

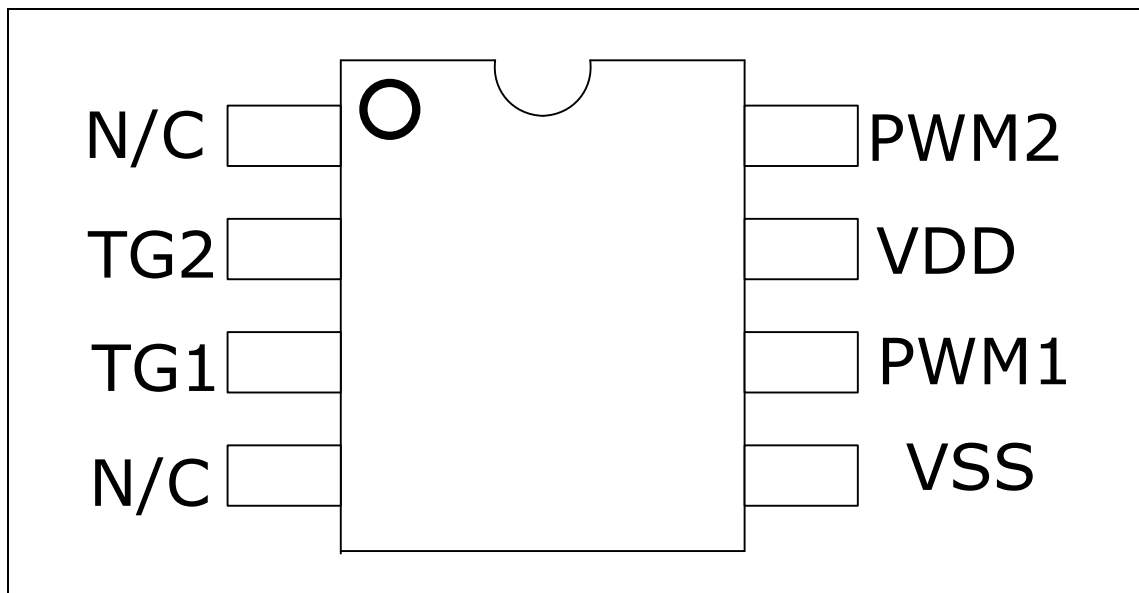

封装脚位图

WZ040 SOP8

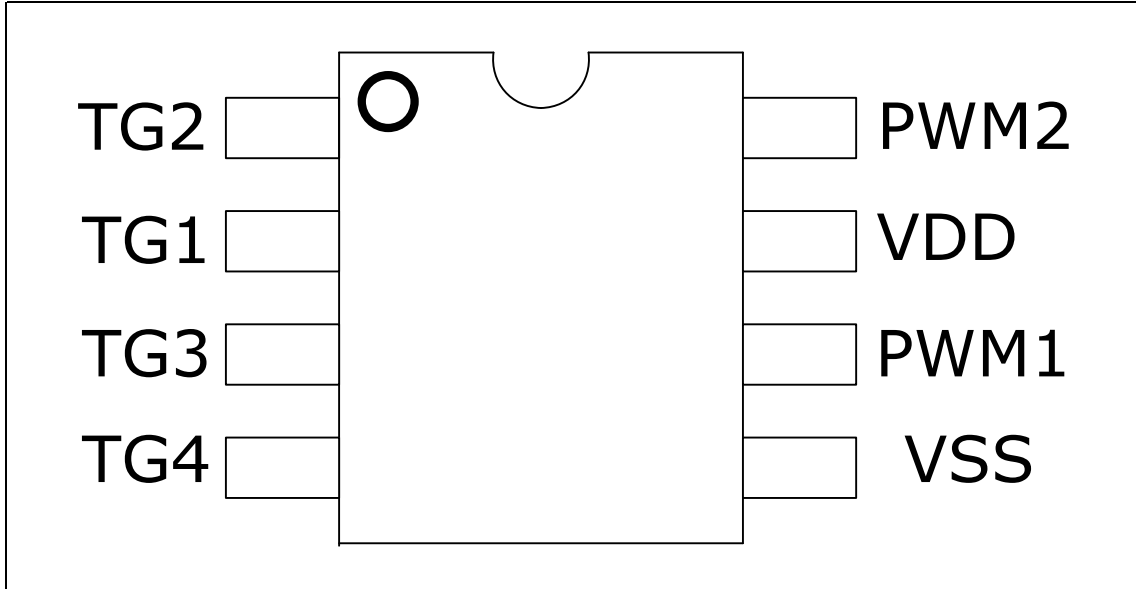

WZ040 SOP8

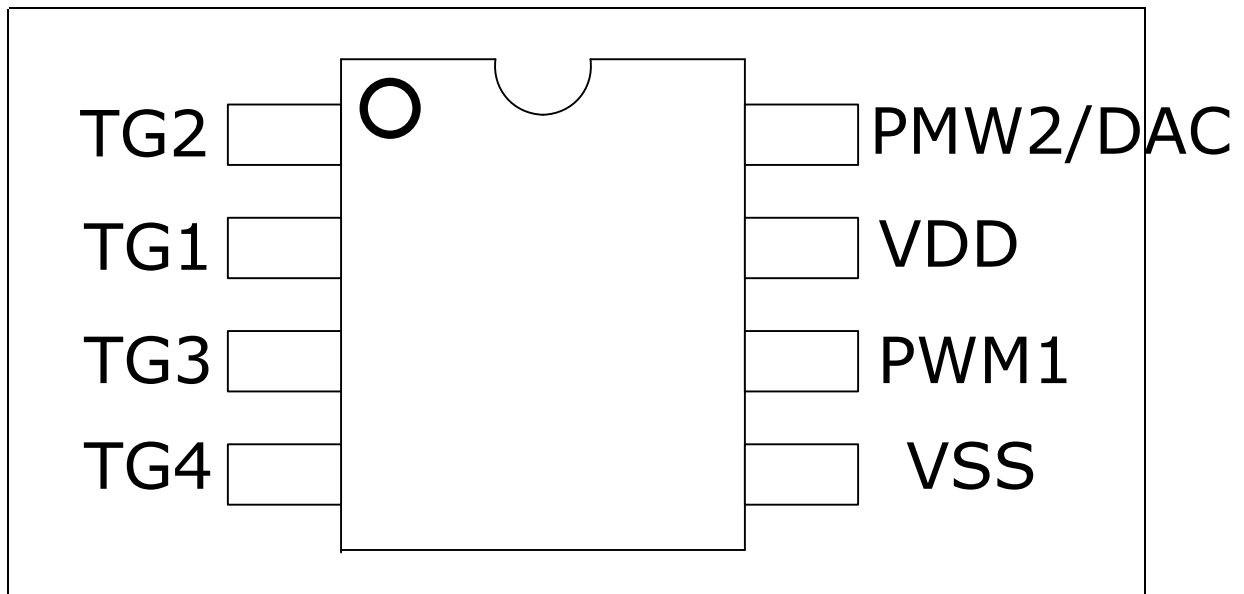

## 应用线路图

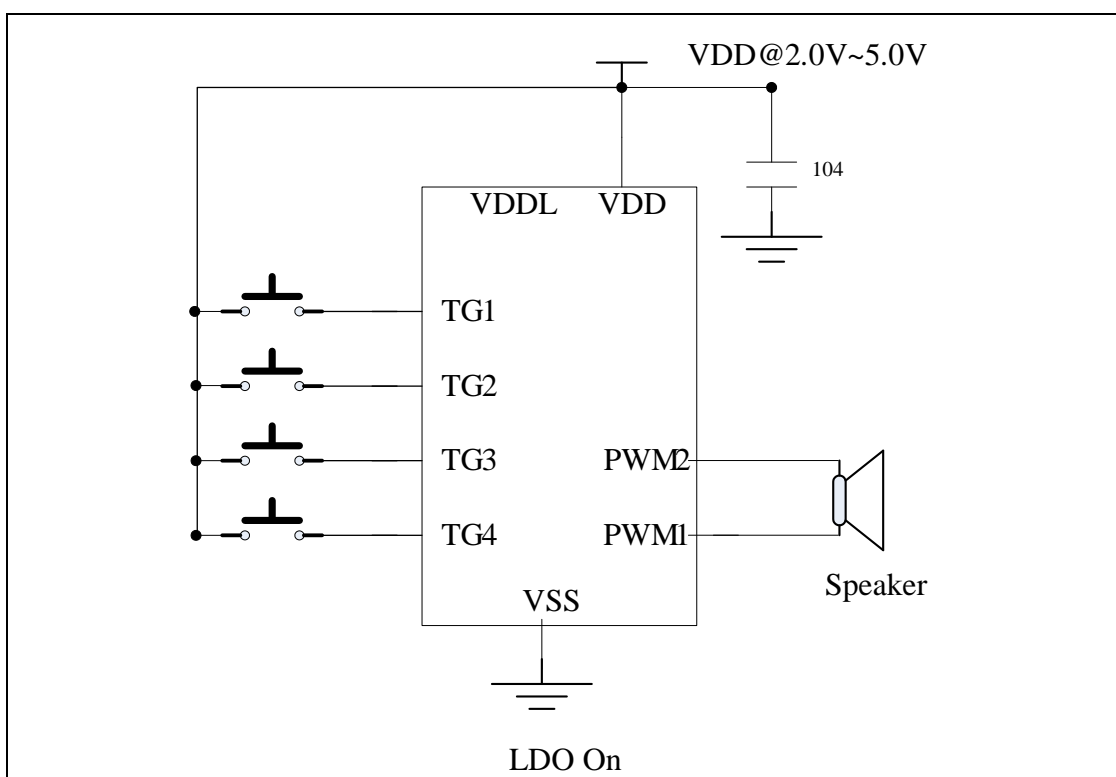
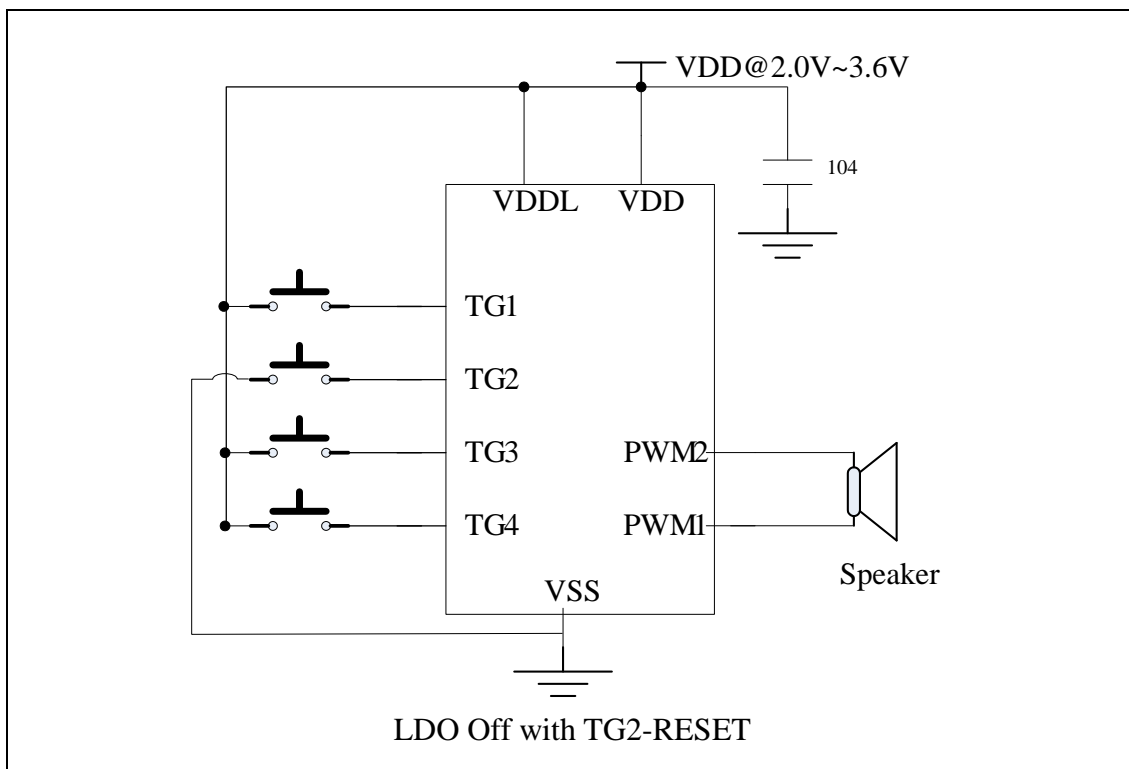

## ◆ Trigger Timing

(a) Trigger Pulse Width < Group Length

Option Setting = Edge / Unhold

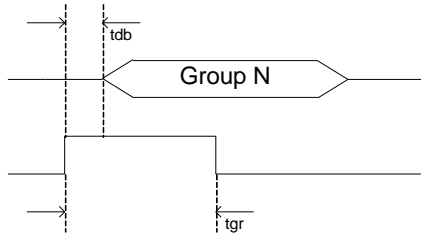

(b) Trigger Pulse Width < Group Length

Option Setting = Edge / Hold

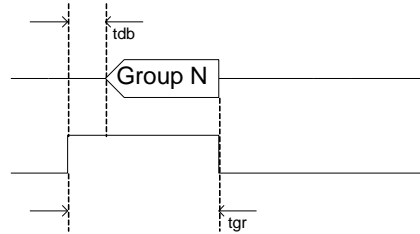

(c) Trigger Pulse Width < Group Length

Option Setting = Level / Unhold

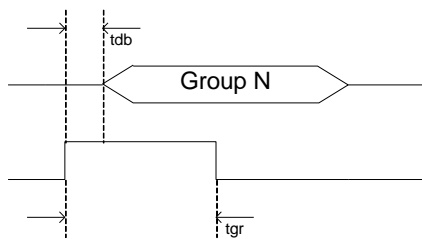

(d) Trigger Pulse Width < Group Length

Option Setting = Level / Hold

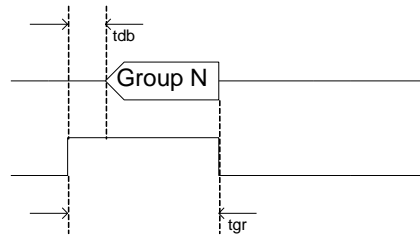

(e) Trigger Pulse Width > Group Length

Option Setting = Edge / Unhold

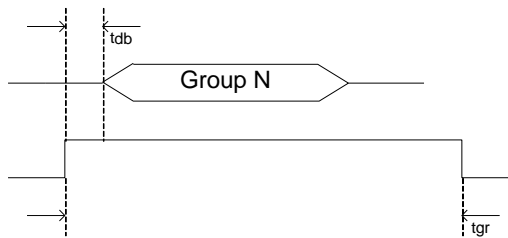

(f) Trigger Pulse Width > Group Length

Option Setting = Edge / Hold

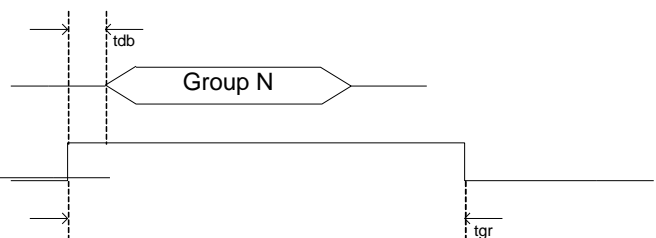

(g) Trigger Pulse Width > Group Length

Option Setting = Level / Unhold

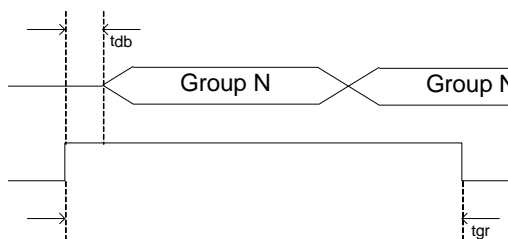

(h) Trigger Pulse Width > Group Length

Option Setting = Level / Hold

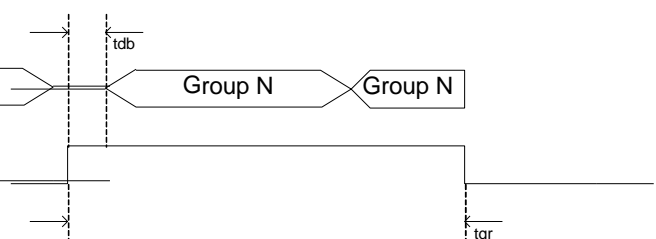

(i) Option Setting = Retrigger

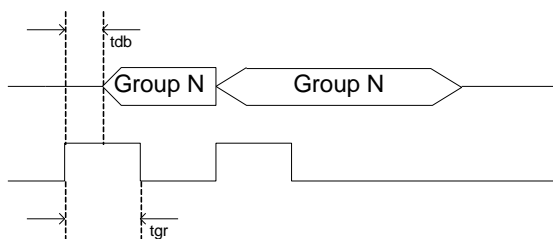

(j) Option Setting = Irretrigger

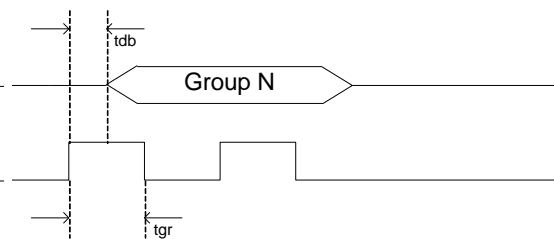

(k) TG1 = Sequential Trigger & From Group1~Group5

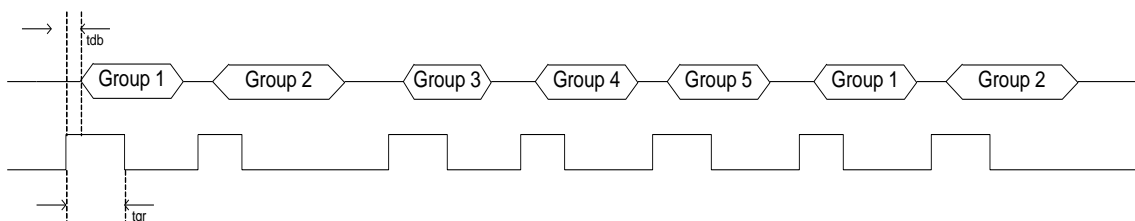

## ◆ Trigger Voice Combination Example

Voice File	Description
Voice File A	Hello ( 1.5" )
Voice File B	Good Morning (3" )
Voice File C	John (1" )
Voice File D	Tom (1" )
Voice File E	Mary (1.5" )

Group1 = Step1 + Step 2

Group 2 = Step3 + Step 4 + Step 5

Group 3 = Step 6 + Step 7

Group1 = Hello John

Group 2= Hello Tom Good Morning

Group 3 = Good Morning Mary

Step1 = Voice File A

Step 2 = Voice File C

Step 3 = Voice File A

Step 4 = Voice File D

Step 5 = Voice File B

Step 6 = Voice File B

Step 7 = Voice File E

Total use 3 Group , 7 Steps

Voice duration= Hello + Good Morning + John + Tom + Mary

$$= 1.5'' + 3'' + 1'' + 1'' + 1.5''$$

$$= 8''$$

Total duration = 8'' ( 40''-8'' = 32'' space are free , can add more Voice File, If body=V53040 )



## ◆ Serial Mode Timing

TG1=Edge/Unhold/Retrigger

TG2=Reset PIN

※Tool: Controller Trigger

### ● PWM

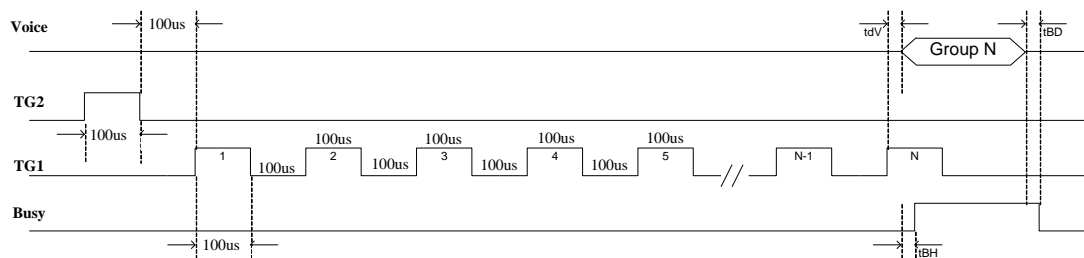

## ◆ MCU Mode Timing

### Play Voice Timing

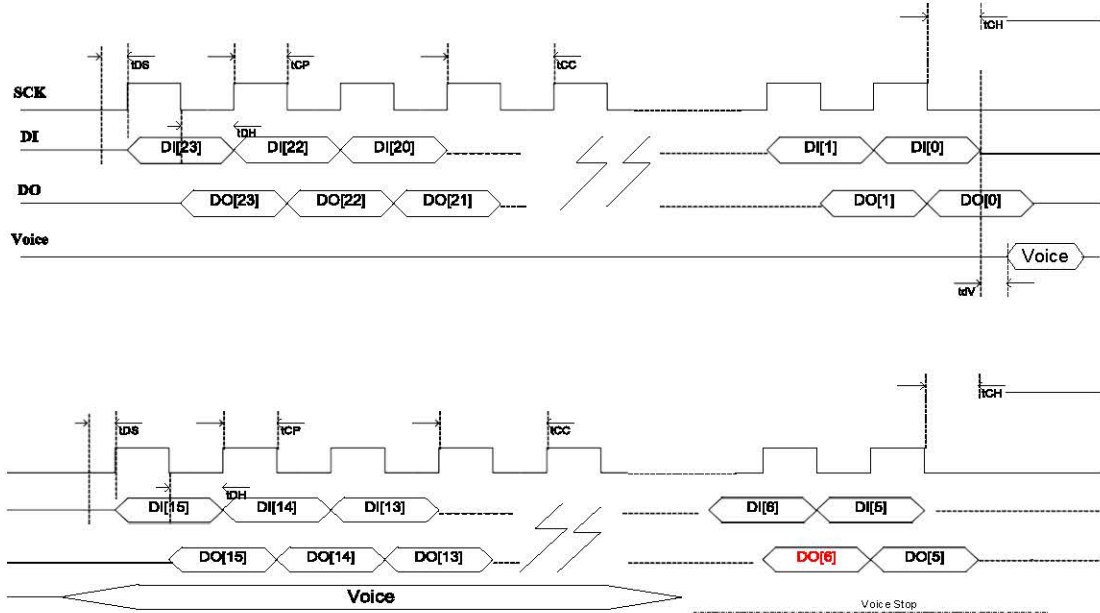

\* DO[6] =1 is Busy , =0 Voice Stop

### Check Voice Stop Timing

Command	PIN	Command Data	Clock Count	Description
Initial	DI	0x1E525B	24 clk	Wake up the chip
	DO			
START	DI	0x0A0140	24 clk	Wake up the chip
	DO			
STOP	DI	0x0A0100	24 clk	Stop up the chip
	DO			
PLAY	DI	0x18+ <b>Group Address</b> Ex:0x00C8	24 clk	Play Voice Step Address
	DO			
PAUSE	DI	0x0A0148	24 clk	Pause the Playback and hold at the Voice data
	DO			
RESUME	DI	0x0A0140	24 clk	Resume Playback from the previous Voice data
	DO			
Read Busy	DI	0x2200	16 clk	Check Voice is Stop or Not
	DO	Check <b>DO[6]</b>		

Play Address Command is generated by the Tool.

## DC Characteristics

Symbol	Parameter	Condition	Min	Typ	Max	Unit
V <sub>OP</sub>	Operating Voltage		2.0		5.0	V
I <sub>sb</sub>	Standby current	LDO On				μA
		LDO OFF				μA
I <sub>OP</sub>	Operating Current	VDD=3V / No Load				μA
I <sub>OD</sub>	Output drive Current					mA
I <sub>OS</sub>	Output sink Current					mA
I <sub>ODPWM</sub>	PWM output drive Current					mA
I <sub>OSPWM</sub>	PWM output sink Current					mA