

-60V P-CHANNEL ENHANCEMENT MODE MOSFET

MAIN CHARACTERISTICS

I_D	-8A
V_{DSS}	-60V
R_{DS(on)-typ}(@V_{GS}=10V)	< 70mΩ (Type:55 mΩ)

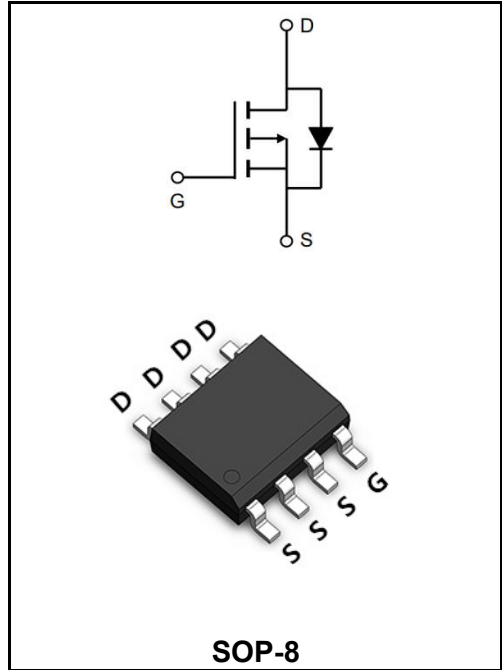

Application

- ◆ Battery protection
- ◆ Load switch
- ◆ Uninterruptible power supply

Product Specification Classification

Part Number	Package	Marking	Pack
YFW8P06S	SOP-8	YFW 8P06S XXXXX	3000PCS/Tape

Maximum Ratings at Tc=25°C unless otherwise specified

Characteristics	Symbols	Value	Units
Drain-Source Voltage	V_{DS}	-60	V
Gate - Source Voltage	V_{GS}	±20	V
Continuous Drain Current, V _{GS} @ -10V ¹ @T _A =25°C	I_D	-8.0	A
Continuous Drain Current, V _{GS} @ -10V ¹ @T _A =70°C	I_D	-3	A
Pulsed Drain Current ²	I_{DM}	-7.5	A
Single Pulse Avalanche Energy ³	E_{AS}	35.3	mJ
Avalanche Current	I_{AS}	-26.6	A
Total Power Dissipation ⁴ @T _A =25°C	P_D	1.5	W
Storage Temperature Range	T_{STG}	-55 to +150	°C
Operating Junction Temperature Range	T_J	-55 to +150	°C
Thermal Resistance Junction-Ambient ¹	R_{θJA}	85	°C/W
Thermal Resistance Junction to Case ¹	R_{θJC}	36	°C/W

Maximum Ratings at Tc=25°C unless otherwise specified

Characteristics	Test Condition	Symbols	Min	Typ	Max	Units
Drain-Source Breakdown Voltage	$V_{GS}=0V, I_D=-250\mu A$	BV_{DSS}	-60	-	-	V
BVDSS Temperature Coefficient	Reference to 25°C, $I_D=-1mA$	$\Delta BV_{DSS}/\Delta T_J$	-	-0.03	-	V/°C
Static Drain-Source On-Resistance ²	$V_{GS}=-10V, I_D=-12A$	$R_{DS(ON)}$	-	55	70	mΩ
	$V_{GS}=-4.5V, I_D=-8A$		-	64	105	
Gate -Threshold Voltage	$V_{DS}=V_{GS}, I_D=-250\mu A$	$V_{GS(th)}$	-1.2	-1.5	-2.5	V
$V_{GS(th)}$ Temperature Coefficient		$\Delta V_{GS(th)}$	-	4.56	-	mV/°C
Drain-Source Leakage Current	$V_{DS}=-48V, V_{GS}=0V, T_J=25^\circ C$	I_{DSS}	-	-	-1	μA
	$V_{DS}=-48V, V_{GS}=0V, T_J=55^\circ C$		-	-	-5	
Gate -Source Leakage Current	$V_{GS}=\pm 20V, V_{DS}=0V$	I_{GSS}	-	-	±100	nA
Forward Transconductance	$V_{DS}=-5V, I_D=-12A$	g_{fs}	-	15.4	-	S
Gate Resistance	$V_{DS}=0V, V_{GS}=0V, f=1MHz$	R_g	-	13.5	-	Ω
Total Gate Charge(-4.5V)	$V_{DS}=-48V$ $V_{GS}=-4.5V$ $I_D=-10A$	Q_g	-	9.86	-	nC
Gate-Source Charge		Q_{gs}	-	3.08	-	
Gate-Drain Charge		Q_{gd}	-	2.95	-	
Turn-on delay time	$V_{DD}=-15V$ $V_{GS}=-10V$ $I_D=-1A$ $R_G=3.3$	$t_{d(on)}$	-	28.8	-	ns
Rise Time		T_r	-	19.8	-	
Turn-Off Delay Time		$t_{d(OFF)}$	-	60.8	-	
Fall Time		t_f	-	7.2	-	
Input Capacitance	$V_{DS}=-15V$ $V_{GS}=0V$ $f=1MHz$	C_{iss}	-	1447	-	pF
Output Capacitance		C_{oss}	-	97.3	-	
Reverse Transfer Capacitance		C_{rss}	-	70	-	
Continuous Source Current ^{1,5}	$V_G=V_D=0V, \text{Force Current}$	I_S	-	-	-18	A
Pulsed Source Current ^{2,5}		I_{SM}	-	-	-36	A
Diode Forward Voltage ²	$V_{GS}=0V, I_S=-1A, T_J=25^\circ C$	V_{SD}	-	-	-1.2	V

Note :

- 1、 The data tested by surface mounted on a 1 inch2 FR-4 board with 2OZ copper.
- 2、 The data tested by pulsed , pulse width $\leq 300\mu s$, duty cycle $\leq 2\%$
- 3、 The EAS data shows Max. rating . The test condition is $V_{DD}=-25V, V_{GS}=-10V, L=0.1mH, I_{AS}=-26.6A$
- 4、 The power dissipation is limited by 150°C junction temperature
- 5、 The data is theoretically the same as ID and IDM , in real applications , should be limited by total power dissipation.

Ratings and Characteristic Curves

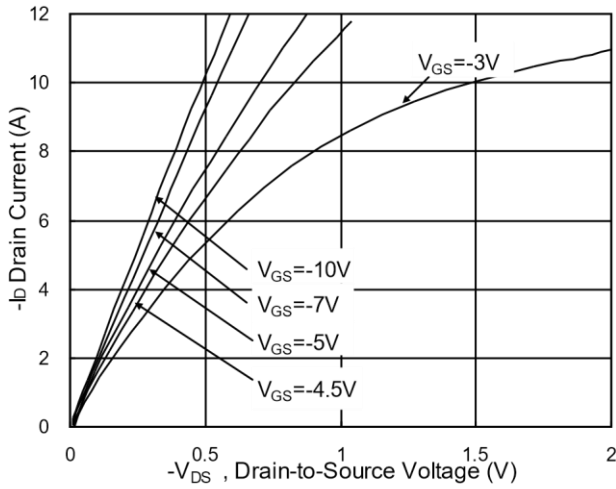

Fig.1 Typical Output Characteristics

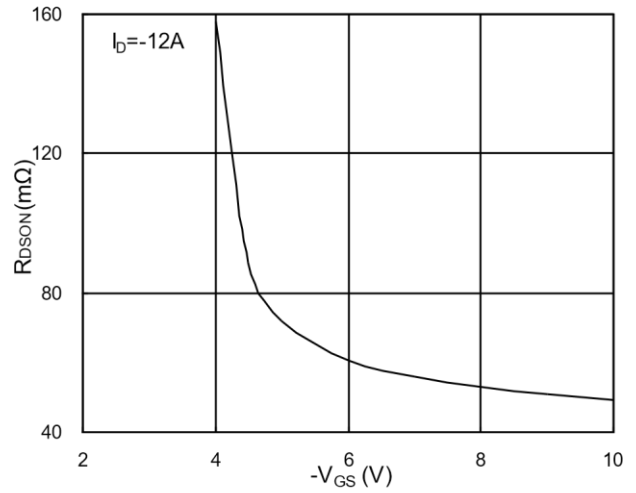

Fig.2 On-Resistance v.s Gate-Source

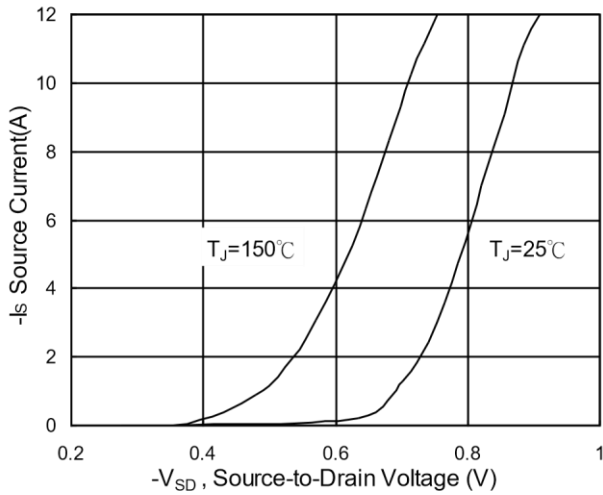

Fig.3 Forward Characteristics of Reverse

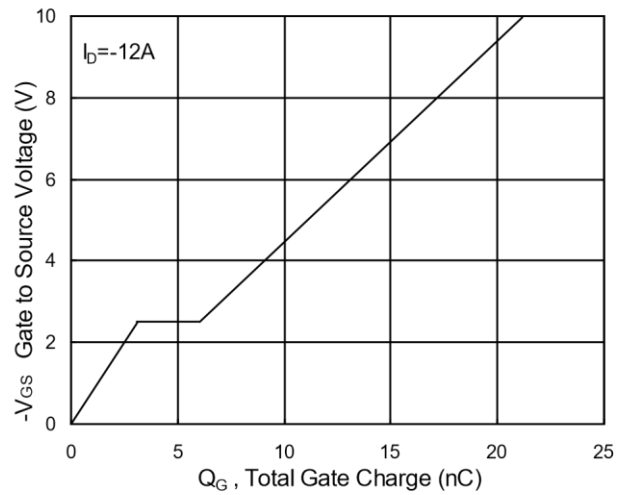

Fig.4 Gate-Charge Characteristics

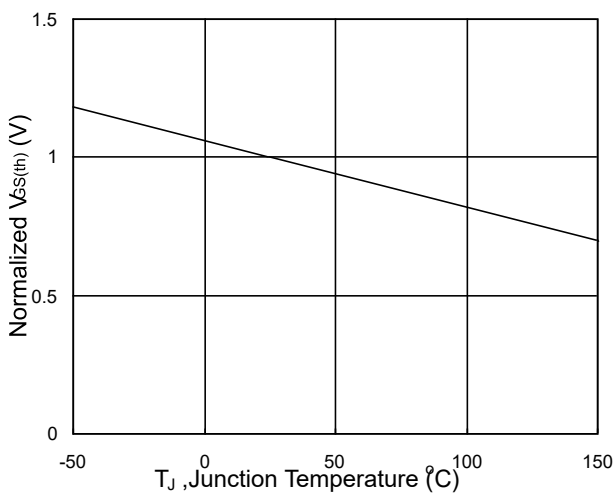

Fig.5 Normalized $V_{GS(th)}$ v.s T_J

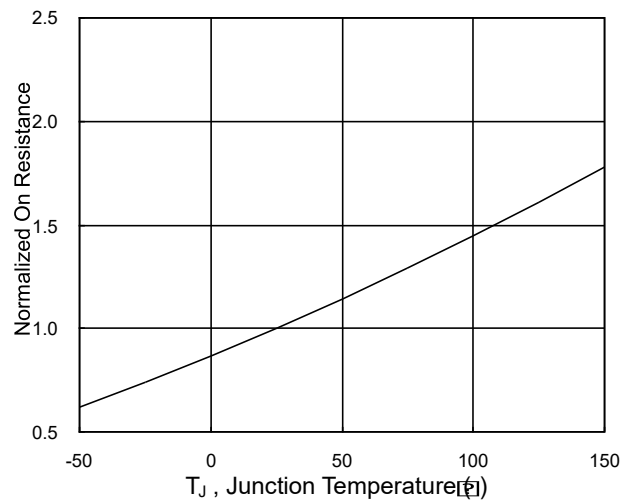

Fig.6 Normalized $R_{DS(on)}$ v.s T_J

Ratings and Characteristic Curves

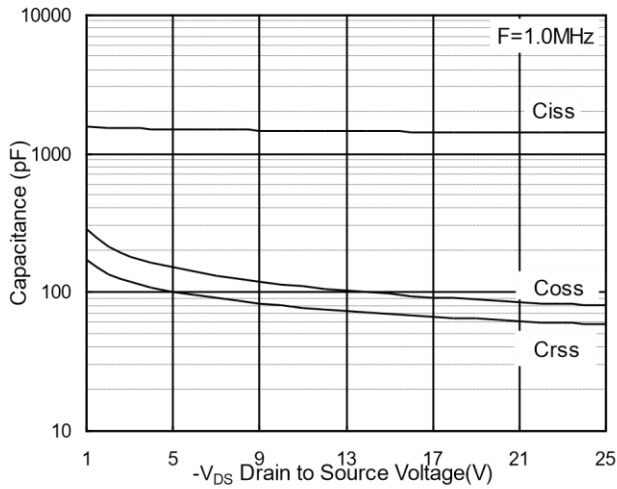

Fig.7 Capacitance

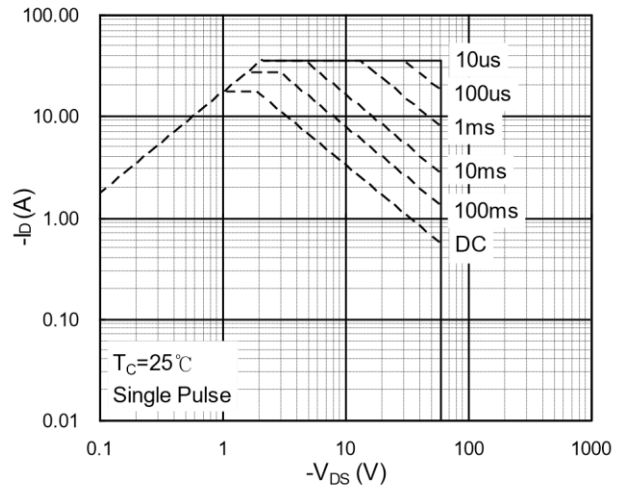

Fig.8 Safe Operating Area

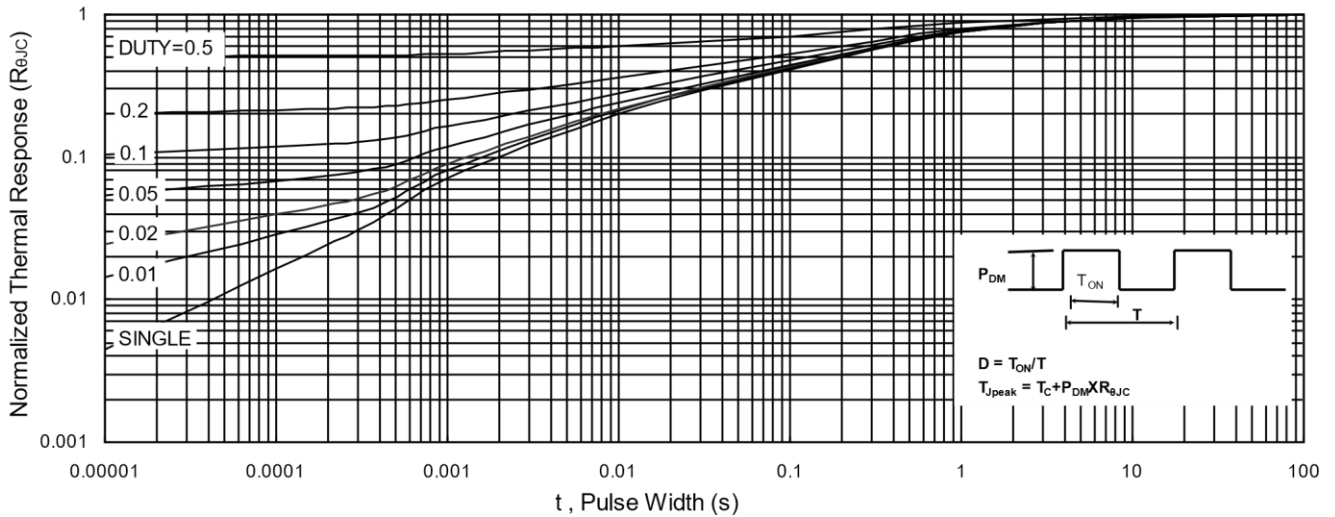

Fig.9 Normalized Maximum Transient Thermal Impedance

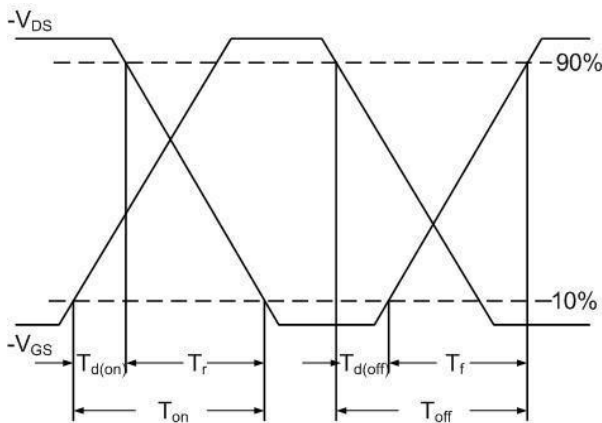

Fig.10 Switching Time Waveform

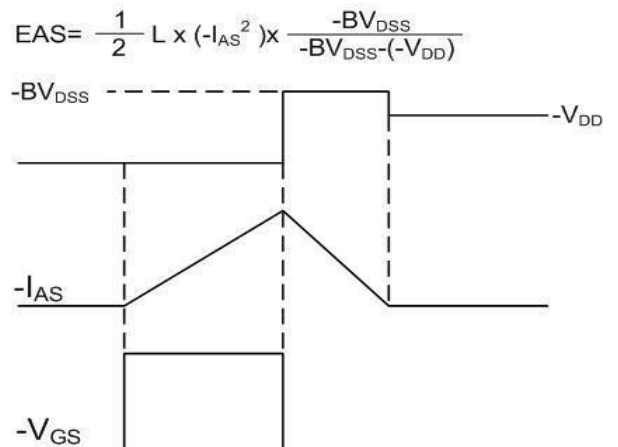
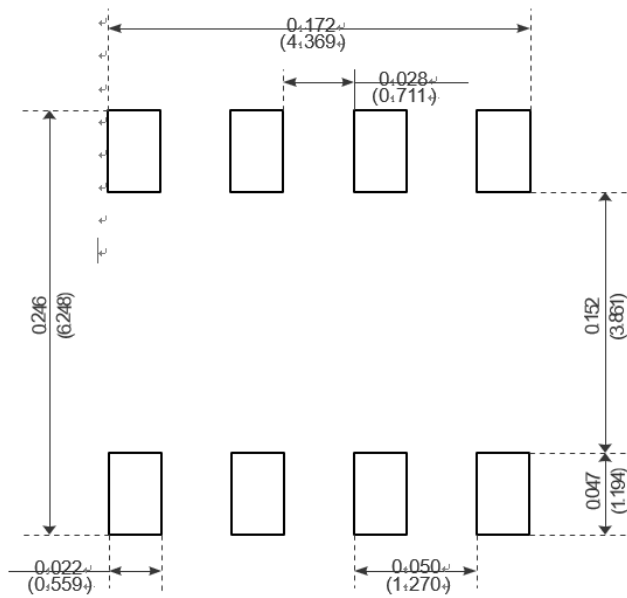
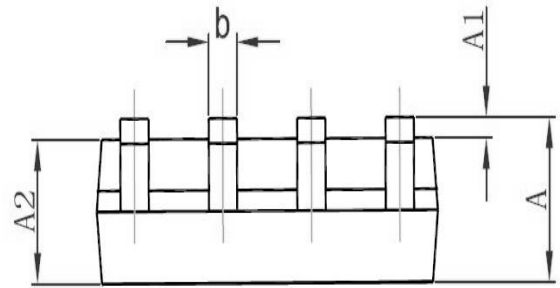
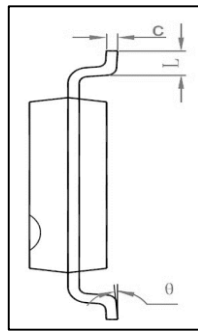
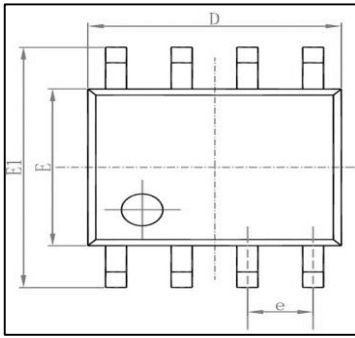

Fig.11 Unclamped Inductive Waveform

Package Outline Dimensions Millimeters

SOP-8



Recommended Minimum Pads

Symbol	Dimensions In Millimeters		Dimensions In Inches	
	Min	Max	Min	Max
A	1.350	1.750	0.053	0.069
A1	0.100	0.250	0.004	0.010
A2	1.350	1.550	0.053	0.061
b	0.330	0.510	0.013	0.020
c	0.170	0.250	0.006	0.010
D	4.700	5.100	0.185	0.200
E	3.800	4.000	0.150	0.157
E1	5.800	6.200	0.228	0.244
e	1.270 (BSC)		0.050 (BSC)	
L	0.400	1.270	0.016	0.050
θ	0°	8°	0°	8°