

40V N-CHANNEL ENHANCEMENT MODE MOSFET

MAIN CHARACTERISTICS

I_D	25A
V_{DSS}	40V
R_{DS(on)-typ(@V_{GS}=10V)}	< 7mΩ (Type: 5.5 mΩ)

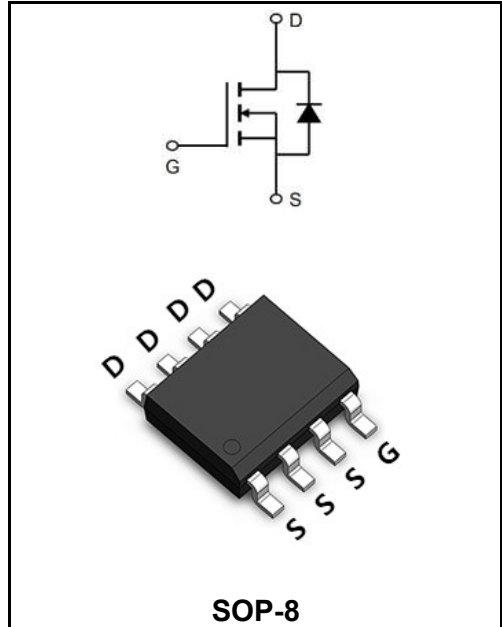

Application

- ◆ Battery protection
- ◆ Load switch
- ◆ Uninterruptible power supply

Product Specification Classification

Part Number	Package	Marking	Pack
YFW25N04S	SOP-8	YFW 25N04S XXXXX	3000PCS/Tape

Maximum Ratings at Tc=25°C unless otherwise specified

Characteristics	Symbols	Value	Units
Drain-Source Voltage	V_{DS}	40	V
Gate - Source Voltage	V_{GS}	±20	V
Continuous Drain Current, V _{GS} @ 10V ¹ @T _A =25°C	I_D	25.5	A
Continuous Drain Current, V _{GS} @ 10V ¹ @T _A =70°C	I_D	18.4	A
Pulsed Drain Current ²	I_{DM}	75	A
Single Pulse Avalanche Energy ³	E_{AS}	176	mJ
Avalanche Current	I_{AS}	39	A
Total Power Dissipation ⁴ @TA=25°C	P_D	1.5	W
Storage Temperature Range	T_{STG}	-55 to +150	°C
Operating Junction Temperature Range	T_J	-55 to +150	°C
Thermal Resistance, Junction-to-Ambient	R_{θJA}	85	°C/W
Thermal Resistance Junction-Case ¹	R_{θJC}	28	°C/W

Maximum Ratings at Tc=25°C unless otherwise specified

Characteristics	Test Condition	Symbols	Min	Typ	Max	Units
Drain-Source Breakdown Voltage	$V_{GS}=0V, I_D=250\mu A$	BV_{DSS}	40	44	-	V
BVDSS Temperature Coefficient	Reference to 25°C , $I_D=1mA$	$\Delta BV_{DSS}/\Delta T_J$	-	0.034	-	V/°C
Static Drain-Source On-Resistance ²	$V_{GS}=10V, I_D=10A$	$R_{DS(ON)}$	-	5.5	7.5	mΩ
	$V_{GS}=4.5V, I_D=8A$		-	6.5	10	
Gate -Threshold Voltage	$V_{DS}=V_{GS}, I_D=250\mu A$	$V_{GS(th)}$	1.0	1.6	2.5	V
$V_{GS(th)}$ Temperature Coefficient		$\Delta V_{GS(th)}$	-	-4.96	-	mV/°C
Drain -Source Leakage Current	$V_{DS}=32V, V_{GS}=0V, T_J=25^\circ C$	I_{DSS}	-	-	1	μA
	$V_{DS}=32V, V_{GS}=0V, T_J=55^\circ C$		-	-	5	
Gate-Source Leakage Current	$V_{GS}=\pm 20V, V_{DS}=0V$	I_{GSS}	-	-	±100	nA
Forward Transconductance	$V_{DS}=5V, I_D=10A$	g_{FS}	-	40	-	S
Gate Resistance	$V_{DS}=0V, V_{GS}=0V, f=1MHz$	R_g	-	1.6	-	
Total Gate Charge(4.5V)	$V_{DS}=20V$ $V_{GS}=4.5V$ $I_D=10A$	Q_g	-	18.8	-	nC
Gate-Source Charge		Q_{gs}	-	4.7	-	
Gate-Drain Charge		Q_{gd}	-	8.2	-	
Turn-on delay time	$V_{DD}=15V$ $V_{GS}=10V$ $R_G=3.3\Omega$ $I_D=1A$	$t_{d(on)}$	-	14.3	-	ns
Rise Time		T_r	-	2.6	-	
Turn-Off Delay Time		$t_{d(OFF)}$	-	77	-	
Fall Time		t_f	-	4.8	-	
Input Capacitance	$V_{DS}=15V$ $V_{GS}=0V$ $f=1.0MHz$	C_{iss}	-	2332	-	pF
Output Capacitance		C_{oss}	-	193	-	
Reverse Transfer Capacitance		C_{rss}	-	138	-	
Continuous Source Current ^{1,5}	$V_G=V_D=0V, \text{Force Current}$	I_S	-	-	10.5	A
Pulsed Source Current ^{2,5}		I_{SM}	-	-	42	A
Diode Forward Voltage ²	$V_{GS}=0V, I_S=1A, T_J=25^\circ C$	V_{SD}	-	-	1	V

Note :

- 1、 The data tested by surface mounted on a 1 inch² FR-4 board with 2OZ copper.
- 2、 The data tested by pulsed , pulse width $\leq 300\mu s$, duty cycle $\leq 2\%$
- 3、 The power dissipation is limited by 175°C junction temperature
- 4、 The data is theoretically the same as ID and IDM , in real applications , should be limited by total power dissipation.

Ratings and Characteristic Curves

Typical Characteristics

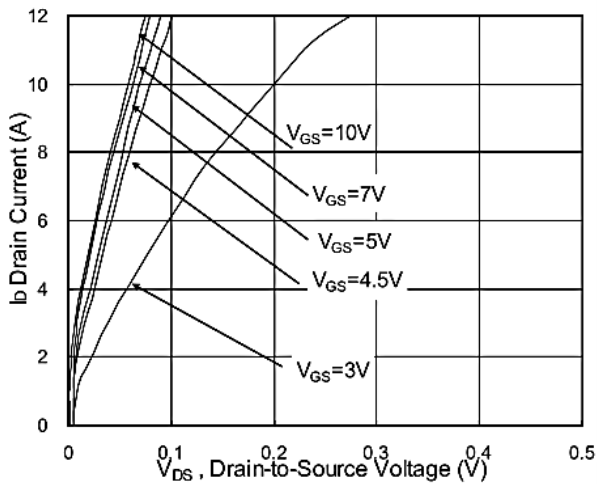

Fig.1 Typical Output Characteristics

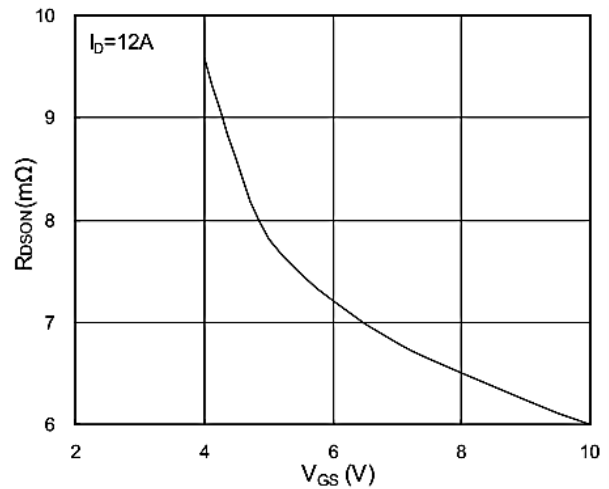

Fig.2 On-Resistance vs. G-S Voltage

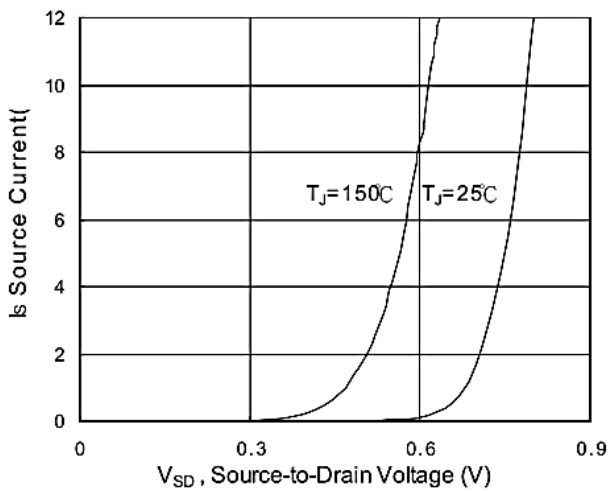

Fig.3 Forward Characteristics of Reverse

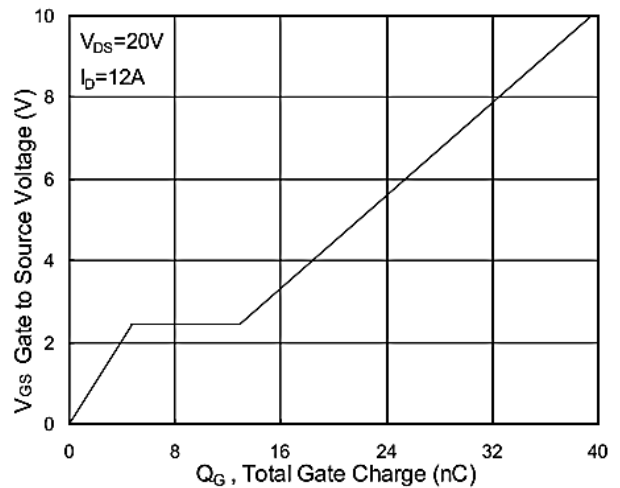

Fig.4 Gate-Charge Characteristics

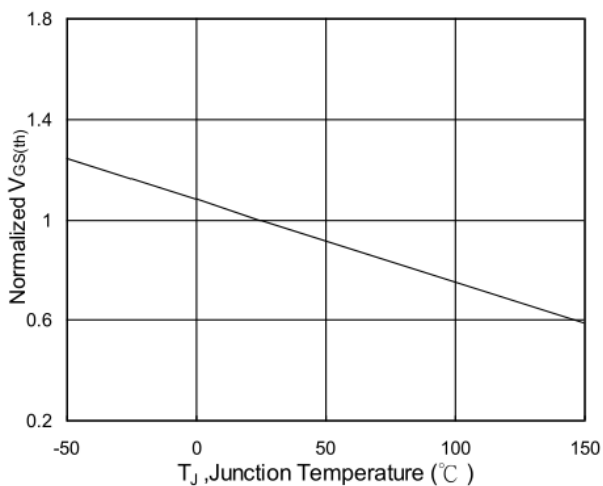

Fig.5 Normalized $V_{GS(th)}$ vs. T_J

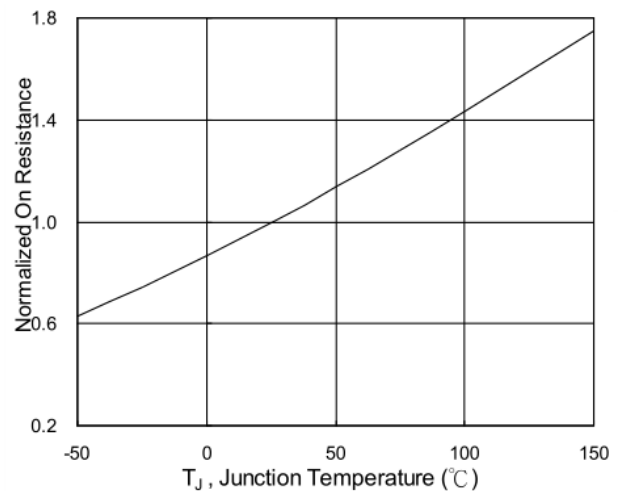

Fig.6 Normalized $R_{DS(on)}$ vs. T_J

Ratings and Characteristic Curves

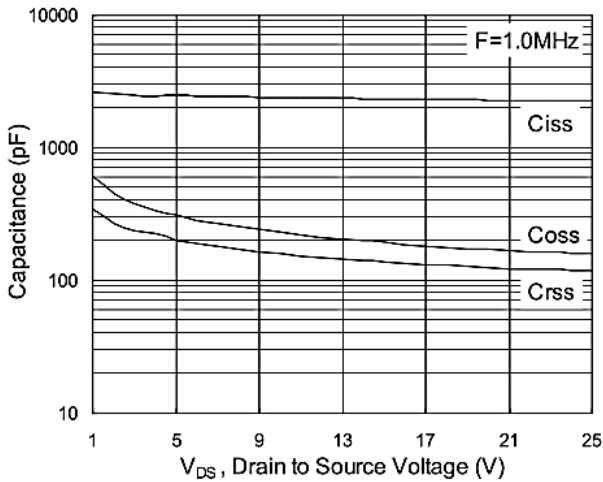

Fig.7 Capacitance

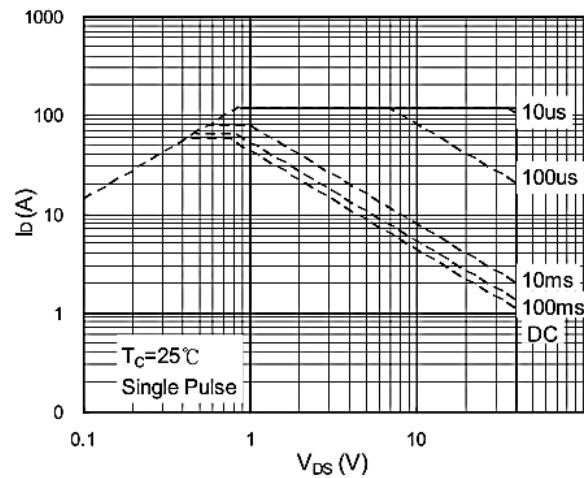

Fig.8 Safe Operating Area

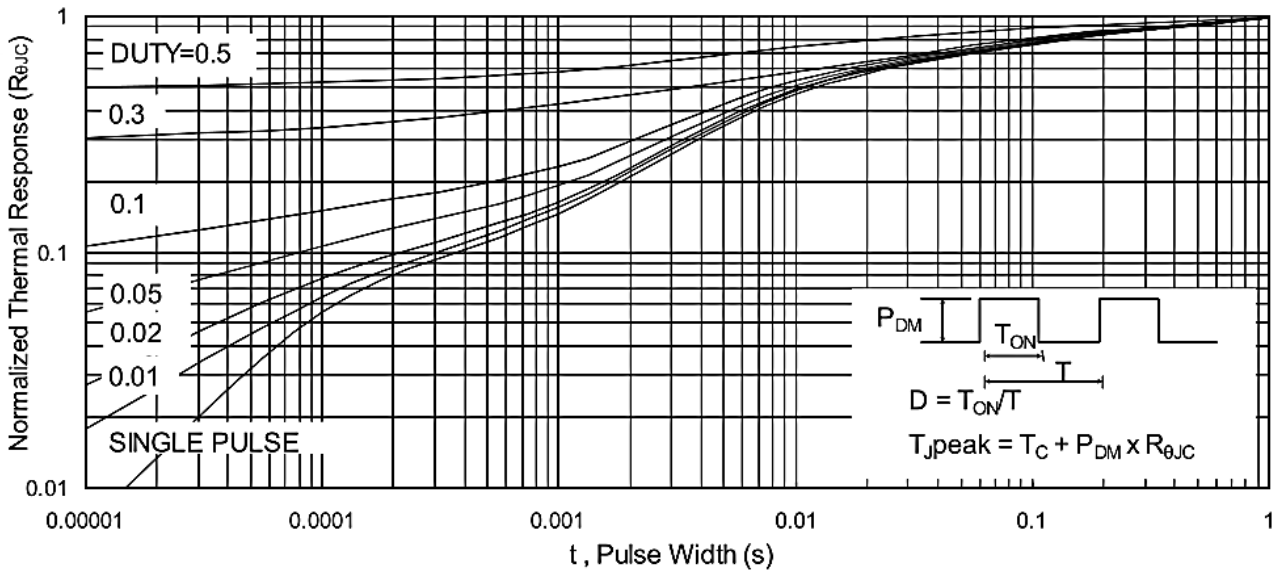

Fig.9 Normalized Maximum Transient Thermal Impedance

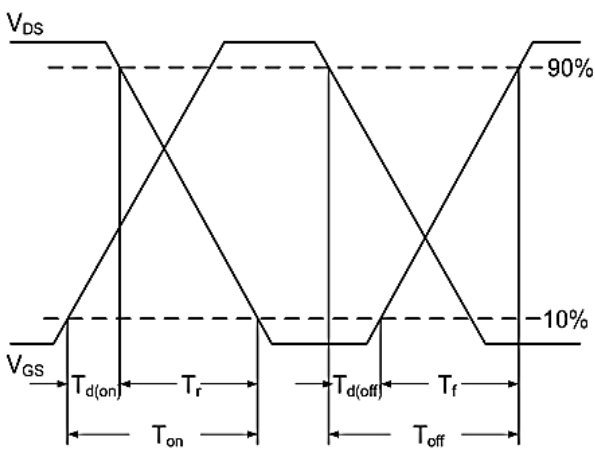

Fig.10 Switching Time Waveform

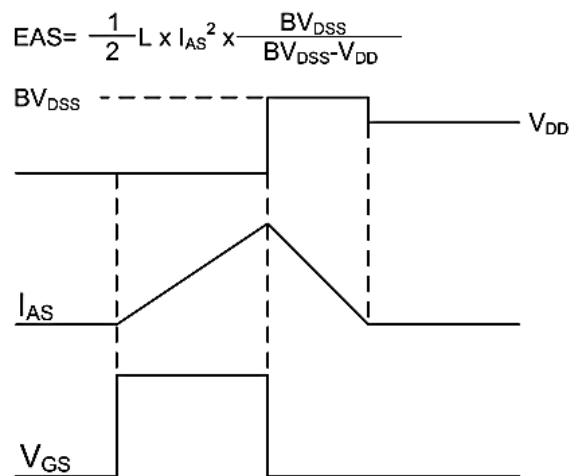
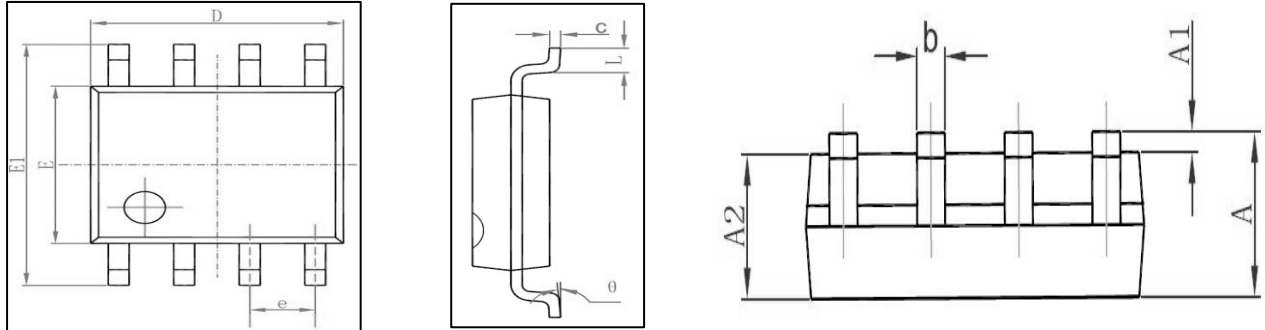
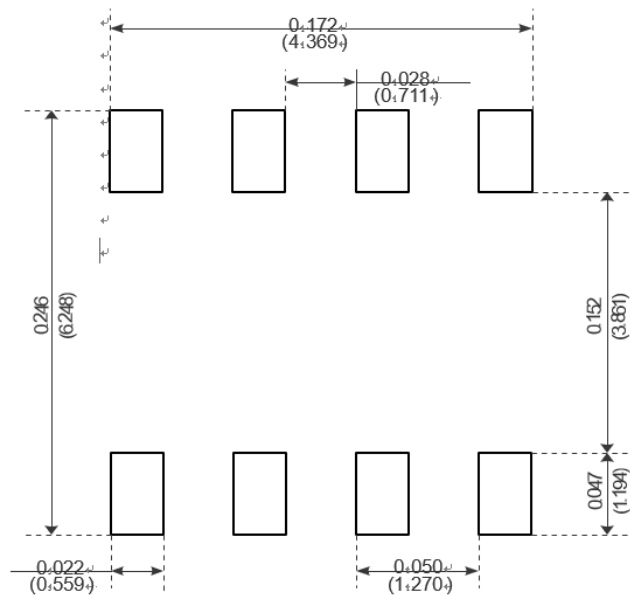

Fig.11 Unclamped Inductive Waveform

SOP-8



Symbol	Dimensions In Millimeters		Dimensions In Inches	
	Min	Max	Min	Max
A	1.350	1.750	0.053	0.069
A1	0.100	0.250	0.004	0.010
A2	1.350	1.550	0.053	0.061
b	0.330	0.510	0.013	0.020
c	0.170	0.250	0.006	0.010
D	4.700	5.100	0.185	0.200
E	3.800	4.000	0.150	0.157
E1	5.800	6.200	0.228	0.244
e	1.270 (BSC)		0.050 (BSC)	
L	0.400	1.270	0.016	0.050
θ	0°	8°	0°	8°



Recommended Minimum Pads