

60V N-CHANNEL ENHANCEMENT MODE MOSFET

MAIN CHARACTERISTICS

I_D	8A
V_{DSS}	60V
R_{DS(on)-typ(@V_{GS}=10V)}	< 40mΩ (Type:35 mΩ)

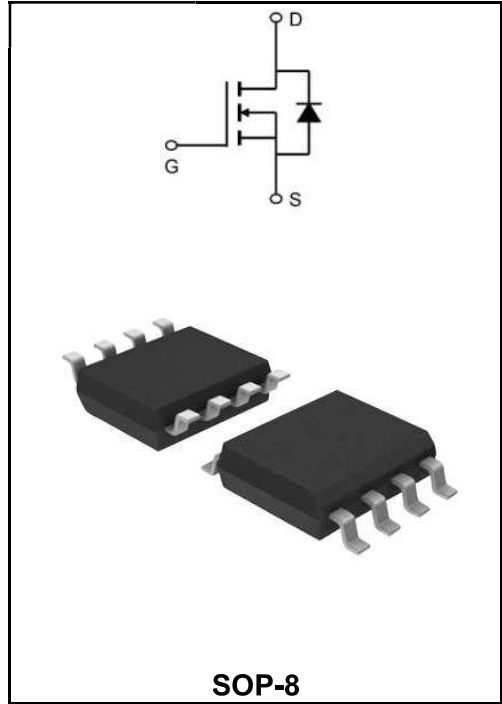

Application

- ◆ Battery protection
- ◆ Load switch
- ◆ Uninterruptible power supply

Product Specification Classification

Part Number	Package	Marking	Pack
YFW8N06S	SOP-8	YFW 8N06S XXXXX	3000PCS/Tape

Maximum Ratings at Tc=25°C unless otherwise specified

Characteristics	Symbols	Value	Units
Drain-Source Voltage	V_{DS}	60	V
Gate - Source Voltage	V_{GS}	±20	V
Continuous Drain Current, V _{GS} @ 10V ¹ @T _A =25°C	I_D	4.5	A
Continuous Drain Current, V _{GS} @ 10V ¹ @T _A =70°C	I_D	3.5	A
Pulsed Drain Current ²	I_{DM}	18	A
Single Pulse Avalanche Energy ³	E_{AS}	22	mJ
Avalanche Current	I_{AS}	21	A
Total Power Dissipation ⁴ @T _A =25°C	P_D	1.5	W
Storage Temperature Range	T_{STG}	-55 to +150	°C
Operating Junction Temperature Range	T_J	-55 to +150	°C
Thermal Resistance Junction-Ambient ¹	R_{θJA}	85	°C/W
Thermal Resistance Junction-Case ¹	R_{θJC}	25	°C/W

Maximum Ratings at Tc=25°C unless otherwise specified

Characteristics	Test Condition	Symbols	Min	Typ	Max	Units
Drain-Source Breakdown Voltage	$V_{GS}=0V, I_D=250\mu A$	BV_{DSS}	60	-	-	V
BVDSS Temperature Coefficient	Reference to 25°C , $I_D=1mA$	$\Delta BV_{DSS}/\Delta T_J$	-	0.044	-	V/°C
Static Drain-Source On-Resistance ²	$V_{GS}=10V, I_D=4A$	$R_{DS(ON)}$	-	35	40	mΩ
	$V_{GS}=4.5V, I_D=2A$		-	45	50	
Gate -Threshold Voltage	$V_{DS}=V_{GS}, I_D=250\mu A$	$V_{GS(th)}$	1.0	-	2.5	V
$V_{GS(th)}$ Temperature Coefficient		$\Delta V_{GS(th)}$	-	-4.8	-	mV/°C
Drain -Source Leakage Current	$V_{DS}=48V, V_{GS}=0V, T_J=25^\circ C$	I_{DSS}	-	-	1	μA
	$V_{DS}=48V, V_{GS}=0V, T_J=55^\circ C$		-	-	5	
Gate-Source Leakage Current	$V_{GS}=\pm 20V, V_{DS}=0V$	I_{GSS}	-	-	±100	nA
Forward Transconductance	$V_{DS}=5V, I_D=4A$	g_{FS}	-	28.3	-	S
Gate Resistance	$V_{DS}=0V, V_{GS}=0V, f=1MHz$	R_g	-	2.5	-	
Total Gate Charge(10V)	$V_{DS}=48V$ $V_{GS}=10V$ $I_D=4A$	Q_g	-	19	-	nC
Gate-Source Charge		Q_{gs}	-	2.6	-	
Gate-Drain Charge		Q_{gd}	-	4.1	-	
Turn-on delay time	$V_{DD}=30V$ $V_{GS}=10V$ $R_G=3.3$ $I_D=4A$	$t_{d(on)}$	-	3	-	ns
Rise Time		T_r	-	34	-	
Turn-Off Delay Time		$t_{d(OFF)}$	-	23	-	
Fall Time		t_f	-	6	-	
Input Capacitance	$V_{DS}=15V$ $V_{GS}=0V$ $f=1.0MHz$	C_{iss}	-	1027	-	pF
Output Capacitance		C_{oss}	-	65	-	
Reverse Transfer Capacitance		C_{rss}	-	46	-	
Continuous Source Current ^{1,5}	$V_G=V_D=0V, \text{Force Current}$	I_S	-	-	4.5	A
Pulsed Source Current ^{2,5}		I_{SM}	-	-	18	A
Diode Forward Voltage ²	$V_{GS}=0V, I_S=1A, T_J=25^\circ C$	V_{SD}	-	-	1.2	V
Reverse Recovery Time	$I_F=4A, dI/dt=100A/\mu s,$ $T_J=25^\circ C$	t_{rr}	-	12.1	-	ns
Reverse Recovery Charge		Q_{rr}	-	6.7	-	nC

Note :

- 1 .The data tested by surface mounted on a 1 inch² FR-4 board with 2OZ copper.
- 2.The data tested by pulsed , pulse width $\leq 300\mu s$, duty cycle $\leq 2\%$
- 3 .The EAS data shows Max. rating . The test condition is $V_{DD}=25V, V_{GS}=10V, L=0.1mH, I_{AS}=21A$
- 4.The power dissipation is limited by 150°C junction temperature
- 5 .The data is theoretically the same as I_D and I_{DM} , in real applications , should be limited by total power dissipation.

Ratings and Characteristic Curves

Typical Characteristics

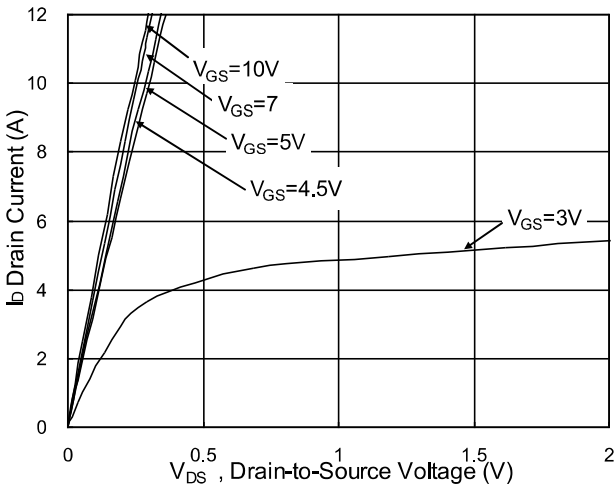

Fig.1 Typical Output Characteristics

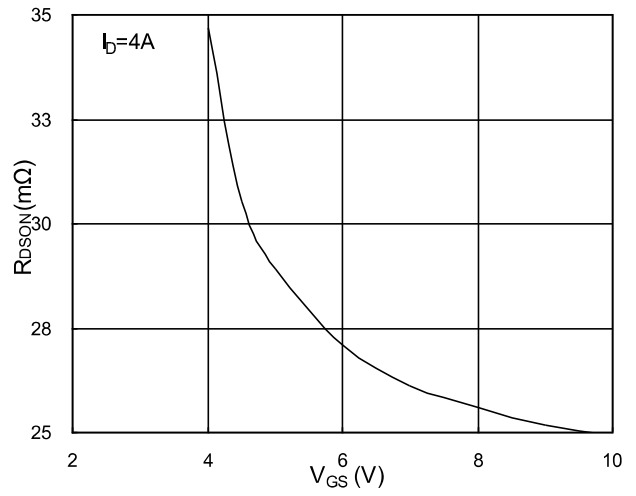

Fig.2 On-Resistance v.s Gate-Source

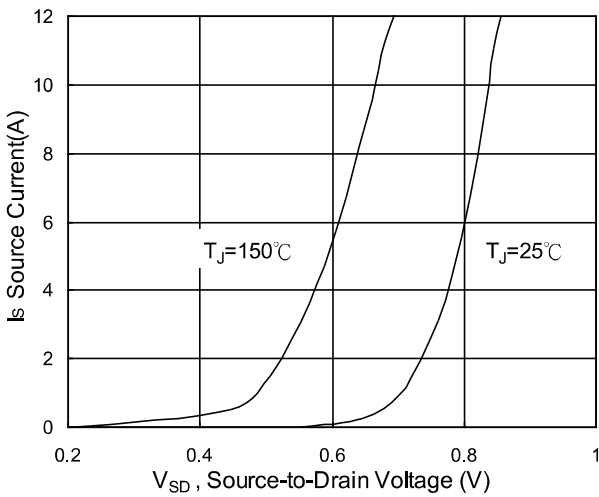

Fig.3 Forward Characteristics of Reverse

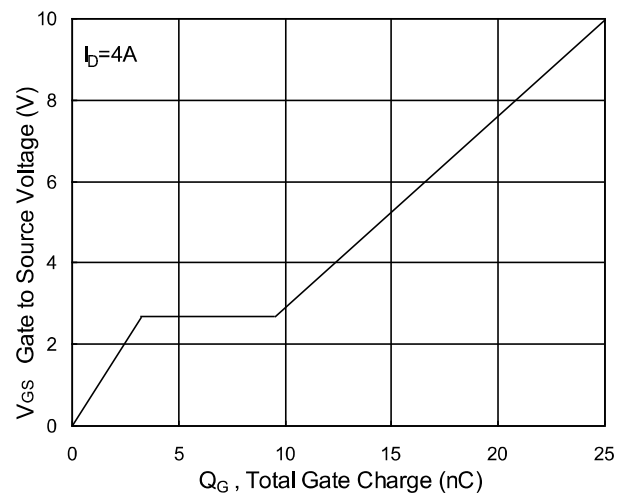

Fig.4 Gate-Charge Characteristics

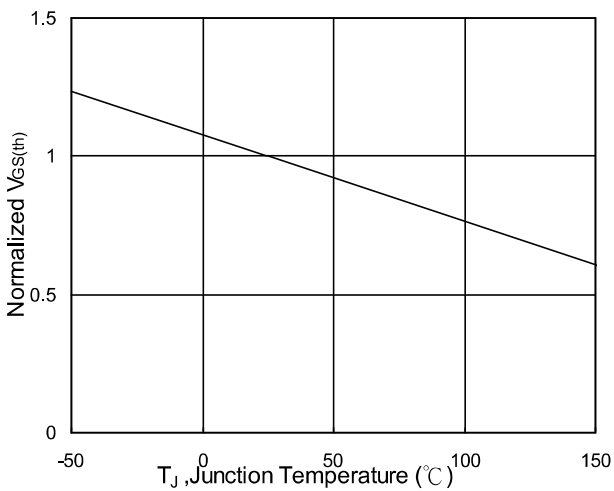

Fig.5 Normalized V_{GS(th)} v.s T_J

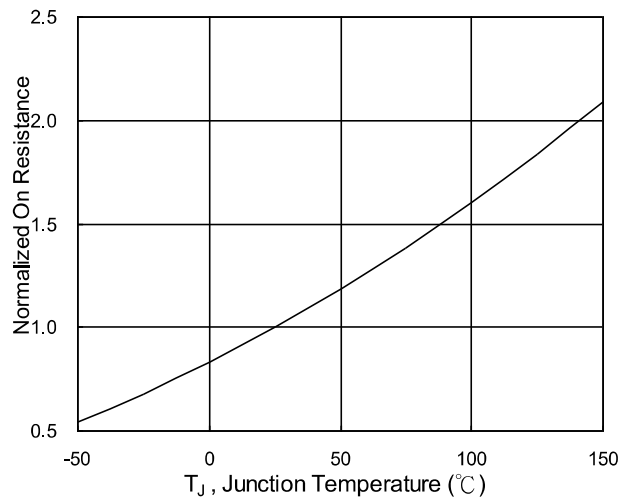

Fig.6 Normalized R_{DS(on)} v.s T_J

Ratings and Characteristic Curves

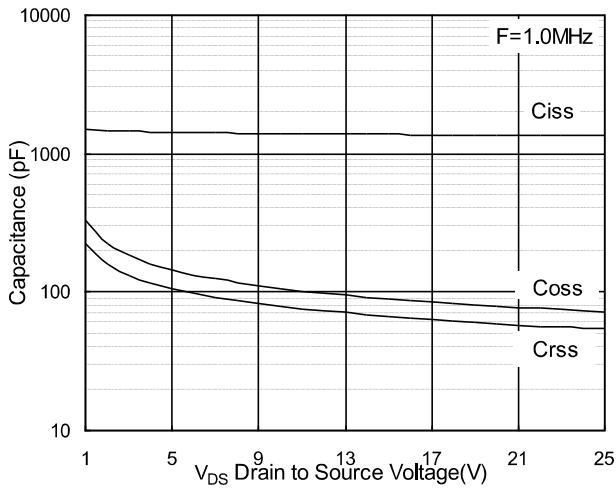

Fig.7 Capacitance

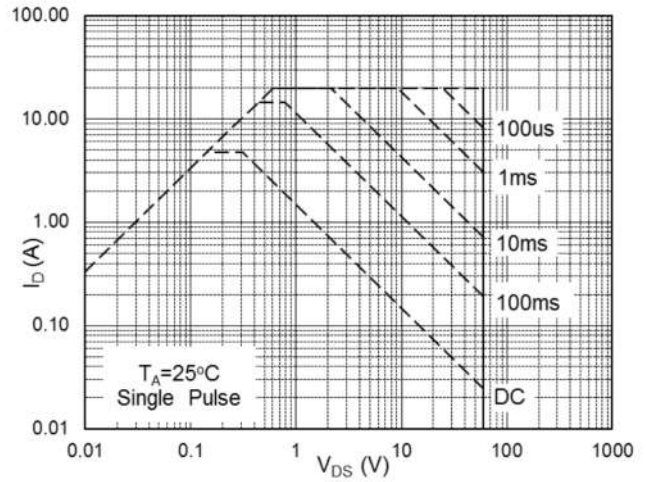

Fig.8 Safe Operating Area

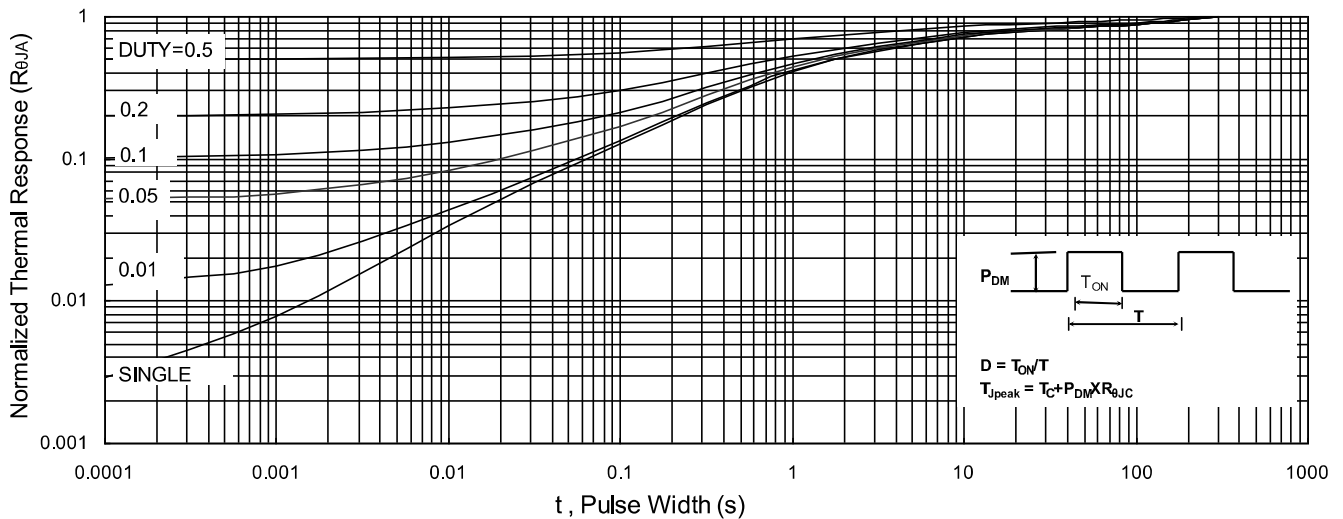

Fig.9 Normalized Maximum Transient Thermal Impedance

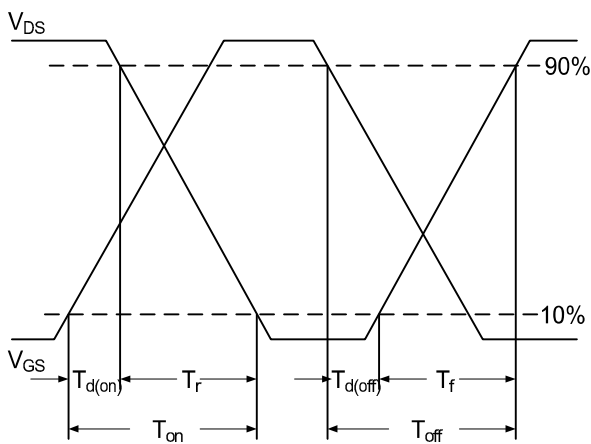

Fig.10 Switching Time Waveform

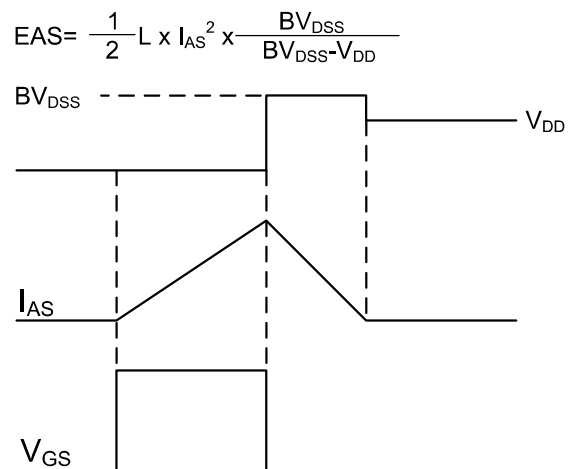
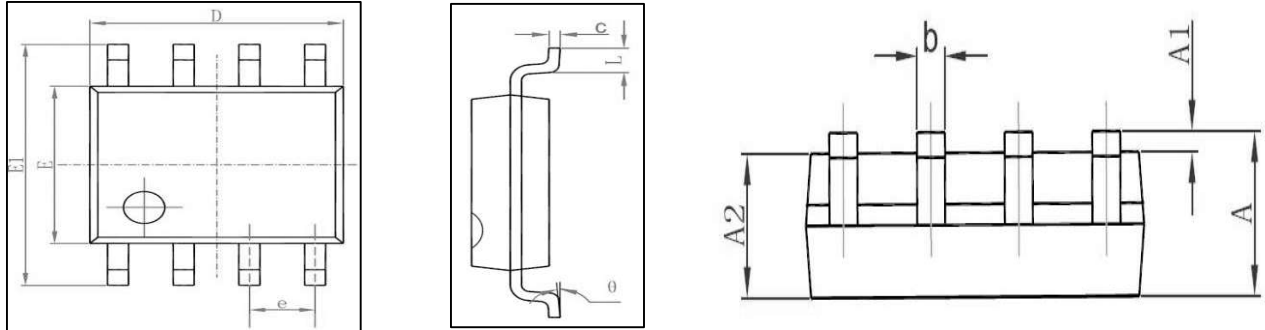
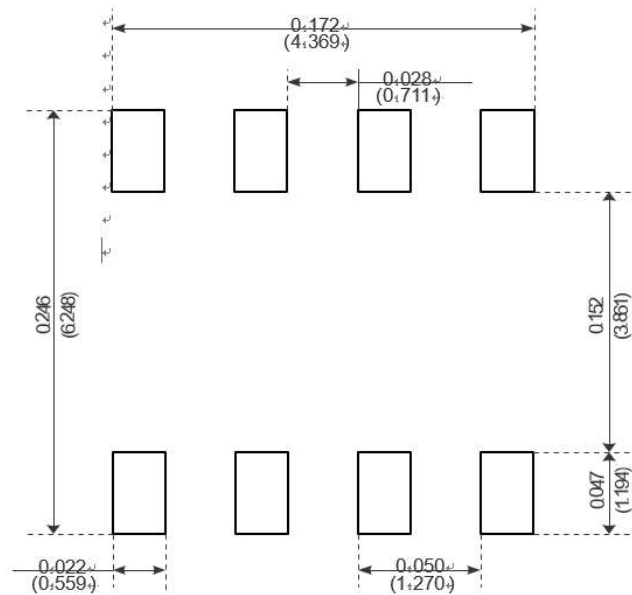

Fig.11 Unclamped Inductive Waveform

SOP-8



Symbol	Dimensions In Millimeters		Dimensions In Inches	
	Min	Max	Min	Max
A	1.350	1.750	0.053	0.069
A1	0.100	0.250	0.004	0.010
A2	1.350	1.550	0.053	0.061
b	0.330	0.510	0.013	0.020
c	0.170	0.250	0.006	0.010
D	4.700	5.100	0.185	0.200
E	3.800	4.000	0.150	0.157
E1	5.800	6.200	0.228	0.244
e	1.270 (BSC)		0.050 (BSC)	
L	0.400	1.270	0.016	0.050
θ	0°	8°	0°	8°



Recommended Minimum Pads