

100V N-CHANNEL ENHANCEMENT MODE MOSFET

MAIN CHARACTERISTICS

I_D	170A
V_{DSS}	100V
R_{DS(on)-typ(@V_{GS}=10V)}	< 3.0mΩ (Type:2.5 mΩ)

Features

- ◆ Low RDS(on) & FOM
- ◆ Extremely low switching loss
- ◆ Excellent stability and uniformity or Invertors
- ◆ **YFW-SGT technology**

Application

- ◆ Consumer electronic power supply Motor control
- ◆ Synchronous-rectification Isolated DC
- ◆ Synchronous-rectification applications

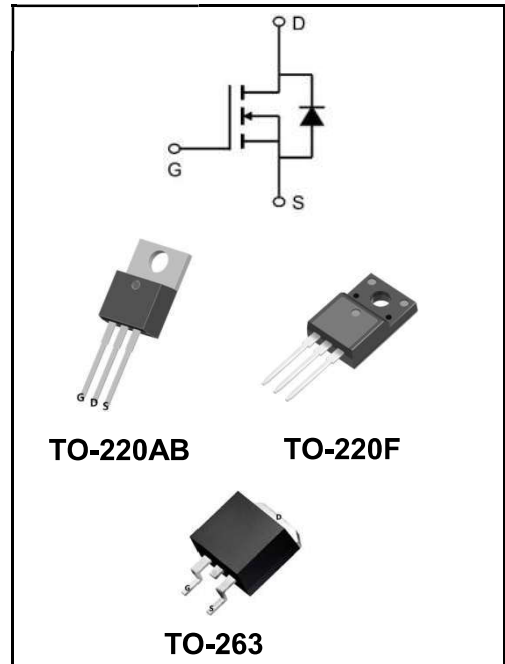

Product Specification Classification

Part Number	Package	Marking	Pack
YFWG170N10AT	TO-220AB	YFW 170N10AT XXXXX	1000PCS/Box
YFWG170N10AF	TO-220F	YFW 170N10AF XXXXX	1000PCS/Box
YFWG170N10AS	TO-263	YFW 170N10AS XXXXX	800PCS/Reel

Maximum Ratings at Tc=25°C unless otherwise specified

Characteristics	Symbols	Value	Units
Drain-Source Voltage	V_{DS}	100	V
Gate - Source Voltage	V_{GS}	±20	V
Continuous drain current ¹⁾	I_D	170	A
Pulsed drain current ²⁾	I_{D, pulse}	540	A
Power dissipation ³⁾	P_D	375	W
Single Pulse Avalanche Energy ⁵⁾	E_{AS}	1000	mJ
Operation and storage temperature	T_{STG}, T_J	-55 to +150	°C
Thermal Resistance, Junction-case	R_{θJC}	0.33	°C/W
Thermal Resistance, Junction-ambient ⁴⁾	R_{θJA}	62.5	°C/W

Maximum Ratings at Tc=25°C unless otherwise specified

Characteristics	Test Condition	Symbols	Min	Typ	Max	Units
Drain-Source Breakdown Voltage	$V_{GS}=0V, I_D=250\mu A$	BV_{DSS}	100	-	-	V
Gate -Threshold Voltage	$V_{DS}=V_{GS}, I_D=250\mu A$	$V_{GS(th)}$	2.0	-	4	V
Drain-source on-state resistance	$V_{GS}=10V, I_D=20A$	$R_{DS(ON)}$	-	2.5	3	mΩ
Gate-Source Leakage Current	$V_{GS}=\pm 20V$	I_{GSS}	-	-	± 100	nA
Drain-Source Leakage Current	$V_{DS}=100V, V_{GS}=0V$	I_{DSS}	-	-	1	μA
Input Capacitance	$V_{GS}=0V$ $V_{DS}=50V$ $f=100KHz$	C_{iss}	-	10952.7	-	pF
Output Capacitance		C_{oss}	-	1402.2	-	
Reverse Transfer Capacitance		C_{rss}	-	33.3	-	
Turn-on delay time	$V_{GS}=10V$ $V_{DS}=50V$ $R_G=2.2\Omega$ $I_D=25A$	$t_{d(on)}$	-	40.7	-	ns
Rise Time		T_r	-	31.4	-	
Turn-Off Delay Time		$t_{d(OFF)}$	-	75.4	-	
Fall Time		t_f	-	16.2	-	
Total Gate Charge	$I_D=25A$ $V_{DS}=50V$ $V_{GS}=10V$	Q_g	-	158.8	-	nC
Gate-Source Charge		Q_{gs}	-	38.4	-	
Gate-Drain Charge		Q_{gd}	-	41.6	-	
Gate plateau voltage		$V_{plateau}$	-	4.6	-	
Diode forward current	$V_{GS}<V_{th}$	I_S	-	-	180	A
Pulsed Source Current		I_{SP}	-	-	540	
Diode Forward Voltage	$I_S=20A, V_{GS}=0V$	V_{SD}	-	-	1.3	V
Reverse Recovery Time	$I_S=25A, dI/dt=100A/\mu s$	t_{rr}	-	99.2	-	ns
Reverse Recovery Charge		Q_{rr}	-	401.9	-	nC
Peak reverse recovery current		I_{rrm}	-	6.7	-	A

- Note
- 1) Calculated continuous current based on maximum allowable junction temperature.
 - 2) Repetitive rating; pulse width limited by max. junction temperature.
 - 3) P_d is based on max. junction temperature, using junction-case thermal resistance.
 - 4) The value of $R_{\theta JA}$ is measured with the device mounted on 1 in 2 FR-4 board with 2oz. Copper, in a still air environment with $T_a=25^\circ C$.
 - 5) $V_{DD}=50V, R_G=25\Omega, L=0.3mH$, starting $T_j=25^\circ C$.

Ratings and Characteristic Curves

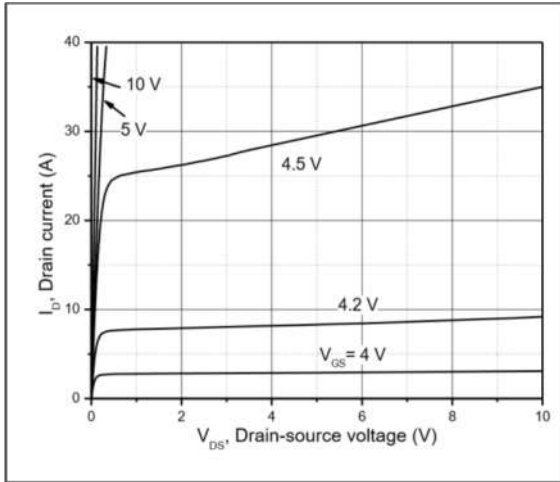

Figure 1, Typ. output characteristics

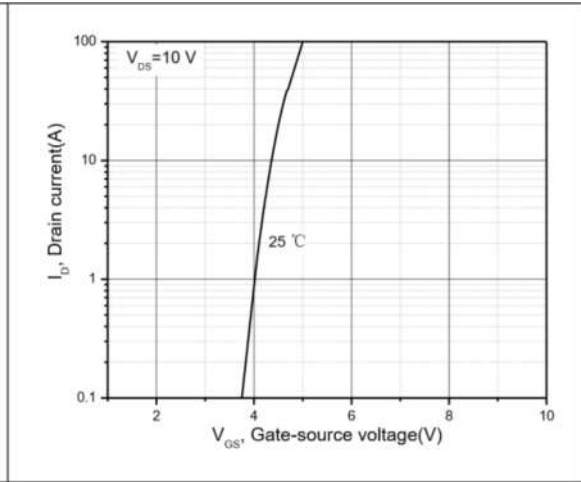

Figure 2, Typ. transfer characteristics

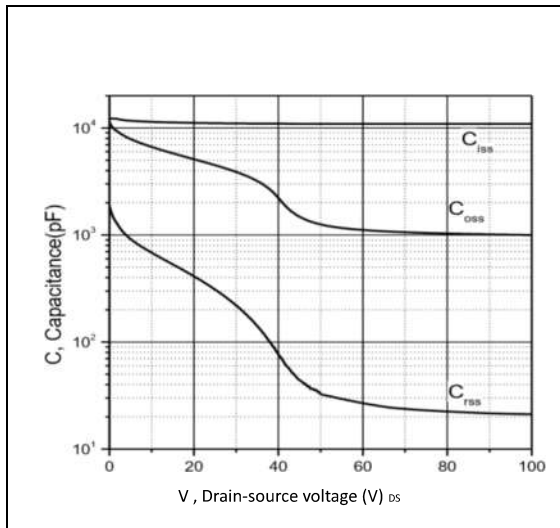

Figure 3, Typ. capacitances

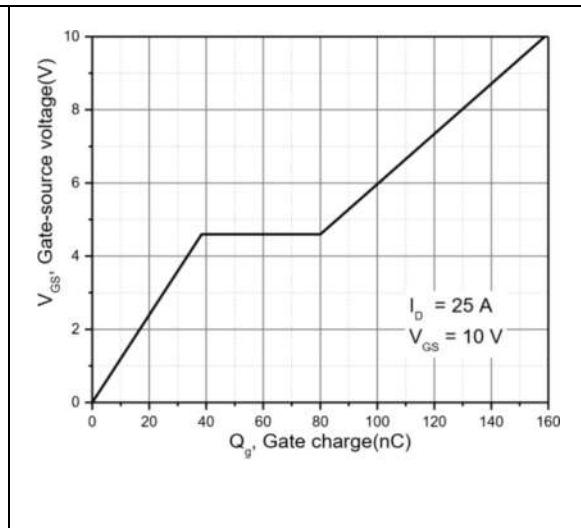

Figure 4, Typ. gate charge

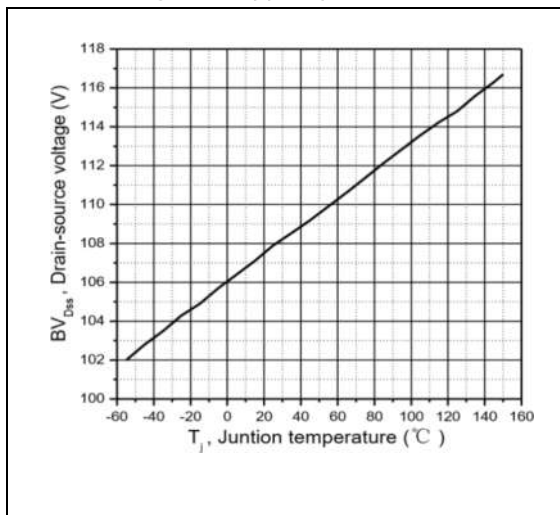

Figure 5, Drain-source breakdown voltage

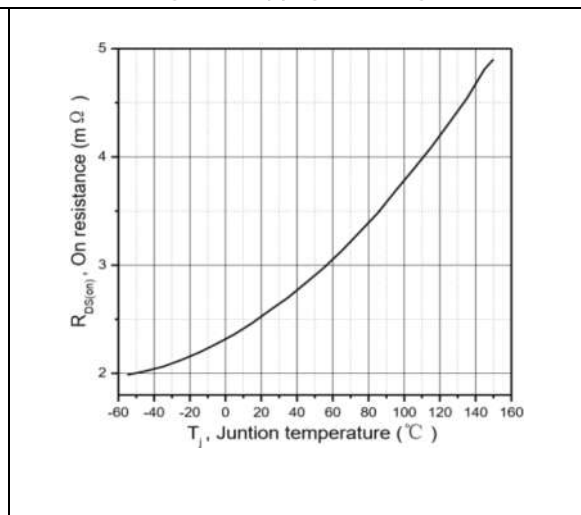

Figure 6, Drain-source on-state resistance

Ratings and Characteristic Curves

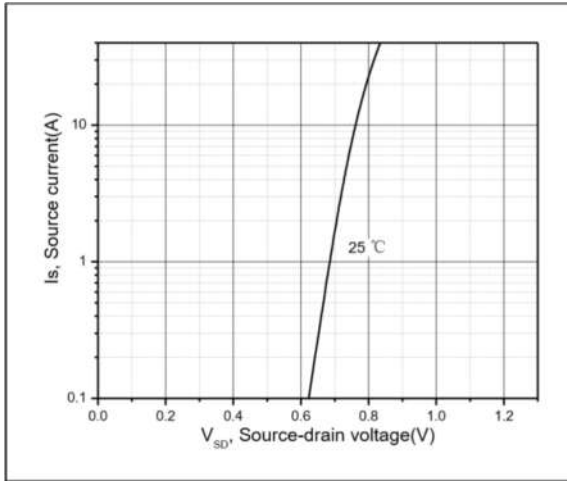

Figure 7, Forward characteristic of body diode

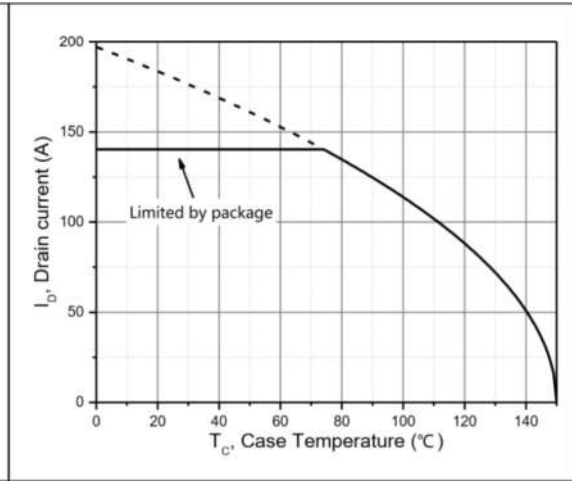

Figure 8, Drain current

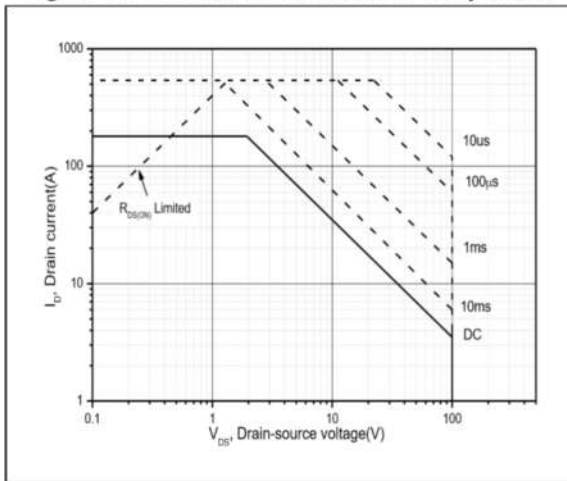

Figure 9, Safe operation area $T_C=25\text{ }^{\circ}\text{C}$

Test circuits and waveforms

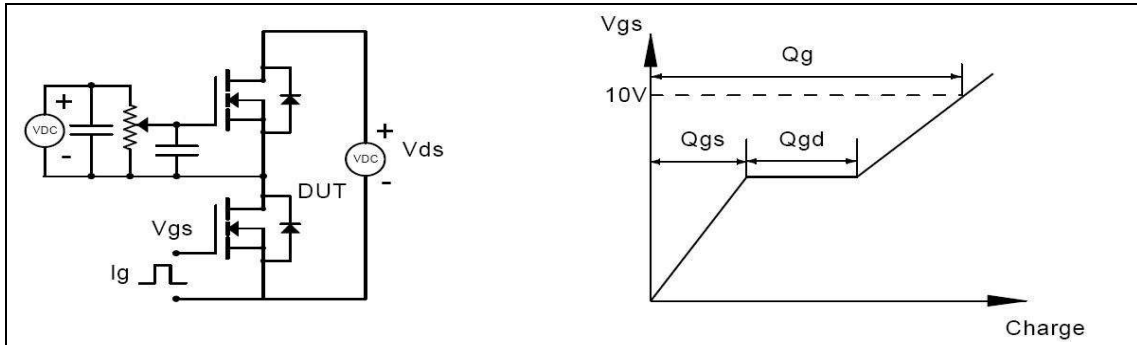

Figure 1, Gate charge test circuit & waveform

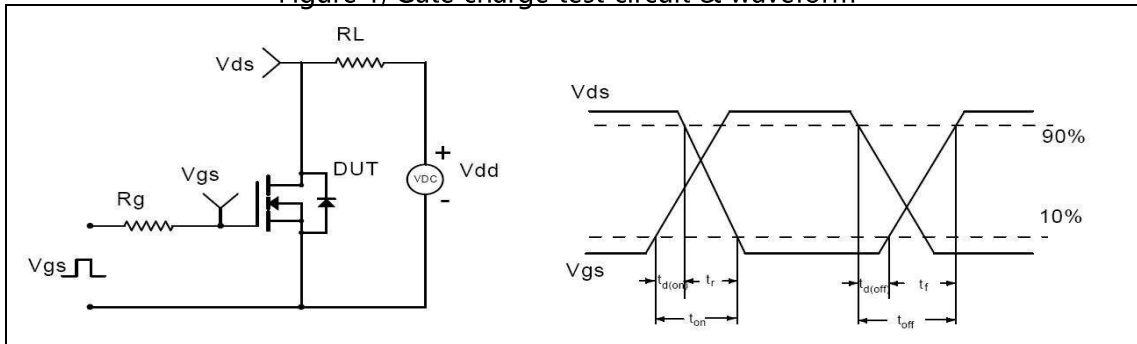

Figure 2, Switching time test circuit & waveforms

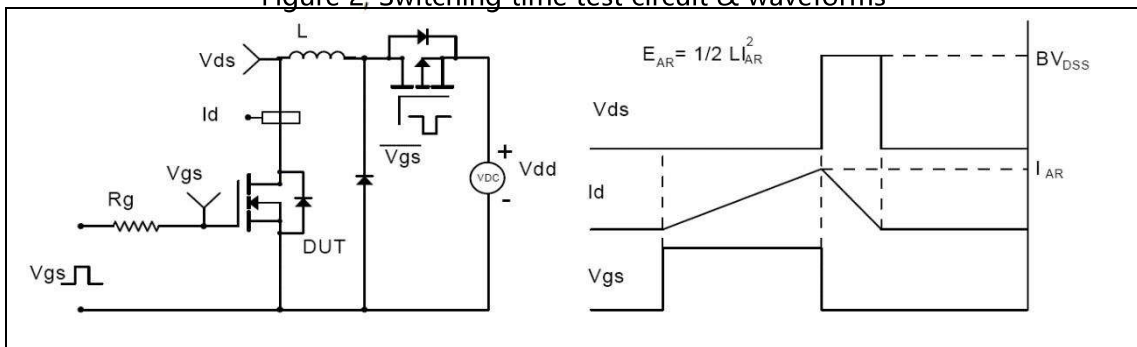

Figure 3, Unclamped inductive switching (UIS) test circuit & waveforms

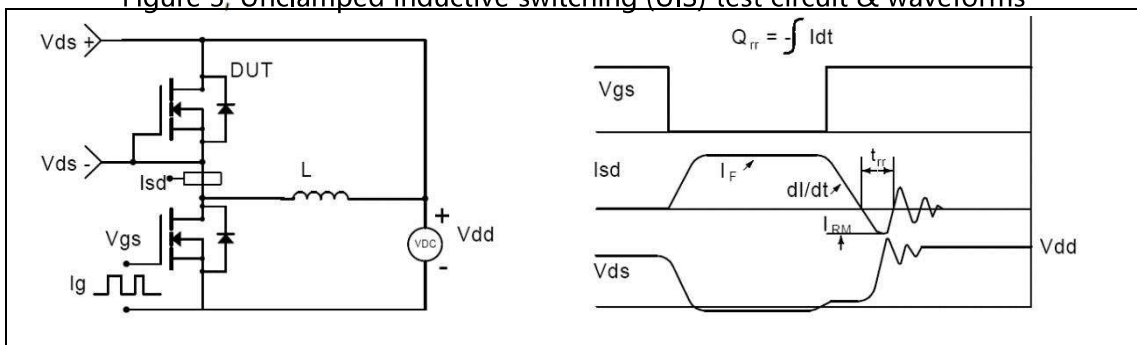

Figure 4, Diode reverse recovery test circuit & waveforms

Package Outline Dimensions Millimeters

TO-220AB

	Dim.	Min.	Max.
	A	10.15	10.35
	B	2.65	2.95
	C	3.70	3.90
	D	28.5	29.5
	E	1.30	1.45
	F	6.35	6.55
	G	2.9	3.3
	H	15.0	16.0
	I	0.38	0.42
	J	4.45	4.55
	K	1.25	1.35
	L	Typ 5.08	
	M	Typ 2.54	
N	3.1	3.3	
O	0.76	0.84	
All Dimensions in millimeter			

TO-220F

	Dim.	Min.	Max.
	A	9.95	10.25
	B	2.95	3.25
	C	1.25	1.45
	D	12.95	13.25
	E	0.50	0.65
	F	3.1	3.3
	G	1.30	1.45
	H	Typ 2.54	
	I	Typ 5.08	
	J	4.60	4.75
	K	2.50	2.65
	L	6.35	6.55
	M	15.4	16.0
	N	2.75	3.05
	O	0.48	0.52
P	0.76	0.84	
All Dimensions in millimeter			

Package Outline Dimensions Millimeters

TO-263

Dim.	Min.	Max.
A	10.1	10.2
B	7.4	7.6
C	1.3	1.5
D	0.55	0.75
E	5.0	6.0
F	1.4	1.6
G	0.78	0.86
H	1.2	1.3
I	Typ2.54	
J	8.4	8.6
K	4.45	4.55
L	1.25	1.35
M	0.02	0.1
N	2.4	2.8
O	0.36	0.40
All Dimensions in millimeter		