

Automotive dual-line TVS in SOT323-3L for CAN bus

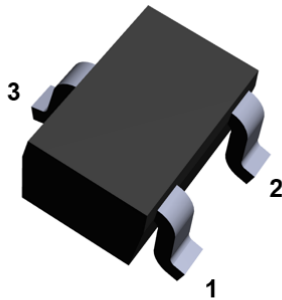

SOT323-3L
(Jedec SC-70)

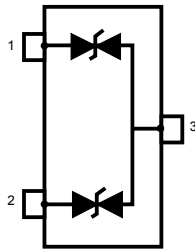

Product status link

ESDCANxx-2BWY	ESDCAN02-2BWY , ESDCAN03-2BWY , ESDCAN04-2BWY , ESDCAN05-2BWY , ESDCAN06-2BWY
---------------	---

Features

- AEC-Q101 qualified 
- Dual-line ESD and EOS protection
- Breakdown voltage, V_{BR} :
 - ESDCAN02-2BWY: 28.5 V
 - ESDCAN03-2BWY: 26.5 V
 - ESDCAN04-2BWY: 27.5 V
 - ESDCAN05-2BWY: 39 V
 - ESDCAN06-2BWY: 38 V
- Bidirectional device
- Max pulse power up to 170 W (8/20 μ s)
- Low clamping factor V_{CL} / V_{BR}
- Low leakage current
- ECOPACK[®]2 ROHS compliant component

Complies with the following standards

- UL94, V0
- J-STD-020 MSL level 1
- IPC7531 footprint and JEDEC registered package
- ISO 16750-2 (Jump start and reversed battery tests)
- ISO 10605 - C = 150 pF, R = 330 Ω , exceeds level 4:
 - ± 30 kV (air discharge)
 - ± 30 kV (contact discharge)
- ISO 10605 - C = 330 pF, R = 330 Ω exceeds level 4:
 - ± 30 kV (air discharge)
 - ± 30 kV (contact discharge)
- ISO 7637-3:
 - Pulse 3a: -150 V
 - Pulse 3b: +150 V
 - Pulse 2a: +/- 85 V

Applications

Automotive controller area network (CAN) bus lines where electrostatic discharges and other transients must be suppressed. These product are compliant with most of automotive interfaces.

Description

These devices are dual-line transient voltage suppressor (TVS) specifically designed for the protection of automotive CAN bus lines against electrostatic discharge (ESD).

Their improved parameters make them compliant with all key drivers in automotive: CAN-FD, LIN, FlexRay, MOST, SENT, USB, etc.

1 Characteristics

Table 1. Absolute ratings ($T_{amb} = 25\text{ °C}$)

Symbol	Parameter		Value	Unit	
V_{PP}	Peak pulse voltage	ISO 10605 - C = 150 pF, R = 330 Ω : Contact discharge	30	kV	
		Air discharge	30		
		ISO 10605 - C = 330 pF, R = 330 Ω : Contact discharge	ESDCAN02-2BWY ESDCAN03-2BWY		30
		Air discharge	ESDCAN04-2BWY		30
		ISO 10605 - C = 330 pF, R = 330 Ω : Contact discharge	ESDCAN05-2BWY ESDCAN06-2BWY		22
		Air discharge			22
I_{PP}	Peak pulse current (8/20 μ s)	ESDCAN02-2BWY ESDCAN03-2BWY ESDCAN04-2BWY	3.7	A	
		ESDCAN05-2BWY ESDCAN06-2BWY	3		
T_j	Operating junction temperature range		-55 to +175	$^{\circ}\text{C}$	
T_{stg}	Storage temperature range		-55 to +175	$^{\circ}\text{C}$	

Figure 1. Electrical characteristics (definitions)

Symbol	Parameter
V_{BR} =	Breakdown voltage
V_{RM} =	Stand-off voltage
V_{CL} =	Clamping voltage
I_{RM} =	Leakage current at V_{RM}
I_{PP} =	Peak pulse current
R_d =	Dynamic impedance
C_{LINE} =	Input capacitance per line

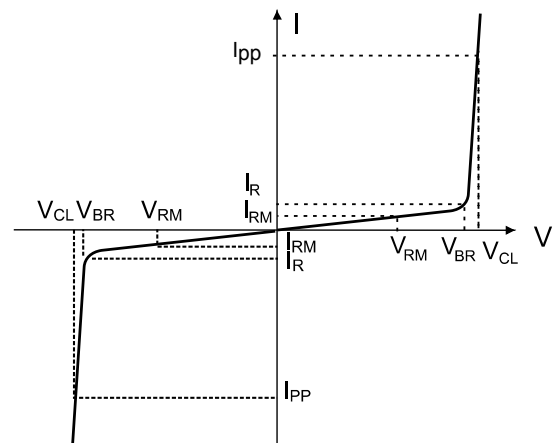

Table 2. Electrical characteristics (values, $T_{amb} = 25\text{ °C}$)

Order code	I_{RM} max. at V_{RM}		V_{BR} at I_R			V_{CL} Pulse ISO7637-3		V_{CL} at I_{PP} (8/20 μ s)		C		$\Delta C^{(1)}$	$\alpha T^{(2)}$
	μ A	V	Min.	Max.	mA	3a at -150 V min.	3b at +150 V max.	Max.	A	Typ.	Max.	Typ.	Typ.
			V			V		V		pF		pF	$10^{-4}/\text{°C}$
ESDCAN02-2BWY	0.01	26.5	28.5	31.7	1	-36	36	44	3	3	3.5	0.01	9
ESDCAN03-2BWY	0.01	24	26.5	29.7	1	-34	34	41	3	3	3.5	0.01	9
ESDCAN04-2BWY	0.05	25.5	27.5	30.7	1	-35	35	43	3	17	19	0.1	9
ESDCAN05-2BWY	0.1	36	39	43.3	1	-45	45	61	3	3	3.5	0.01	9
ESDCAN06-2BWY	0.1	35	38	42.2	1	-44	44	59	3	13	15	0.1	9

1. ΔC : capacitance variation between IO1 and IO2 versus GND

2. to calculate V_{BR} versus T_j : V_{BR} at $T_j = V_{BR}$ at $25\text{ °C} \times (1 + \alpha T \times (T_j - 25))$

1.1 Characteristics (curves)

Figure 2. Maximum peak current versus initial junction temperature

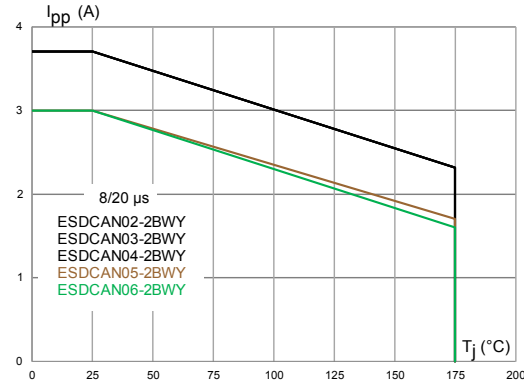

Figure 3. Maximum peak pulse current versus exponential pulse duration

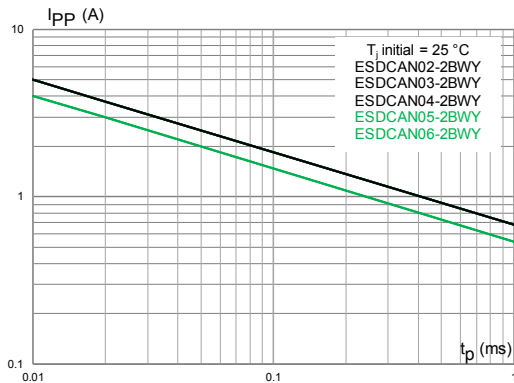

Figure 4. Peak pulse current versus clamping voltage

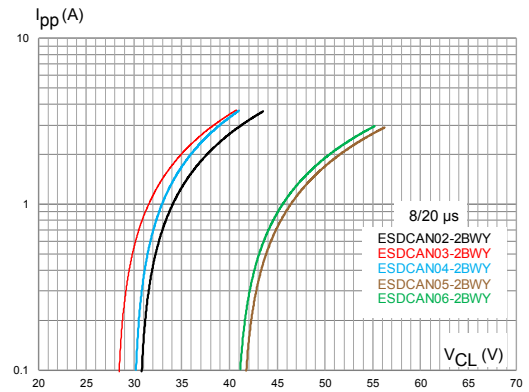

Figure 5. Junction capacitance versus reverse applied voltage

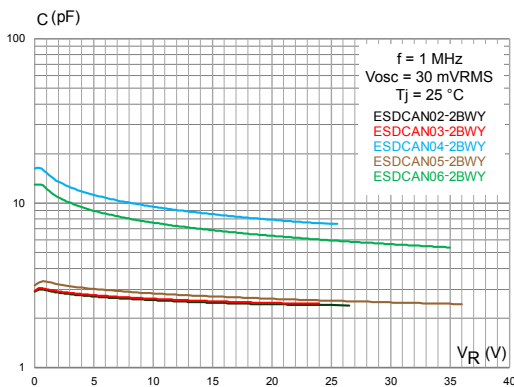

Figure 6. Leakage current versus junction temperature

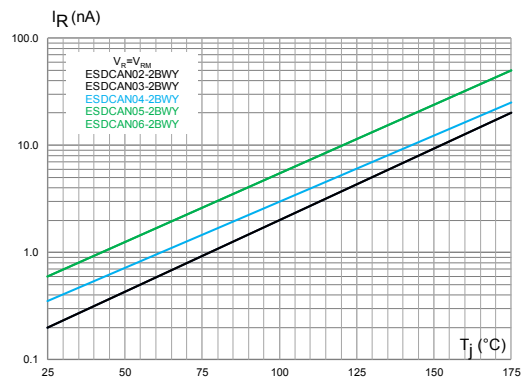

Figure 7. Response to ISO 10605 -C = 150 pF, R = 330 Ω (-8 kV contact)

Figure 8. Response to ISO 10605 - C = 150 pF, R = 330 Ω (+8 kV contact)

Figure 9. Response to ISO 7637-3 Pulse 3a: -150 V

Figure 10. Response to ISO 7637-3 Pulse 3b : +150 V

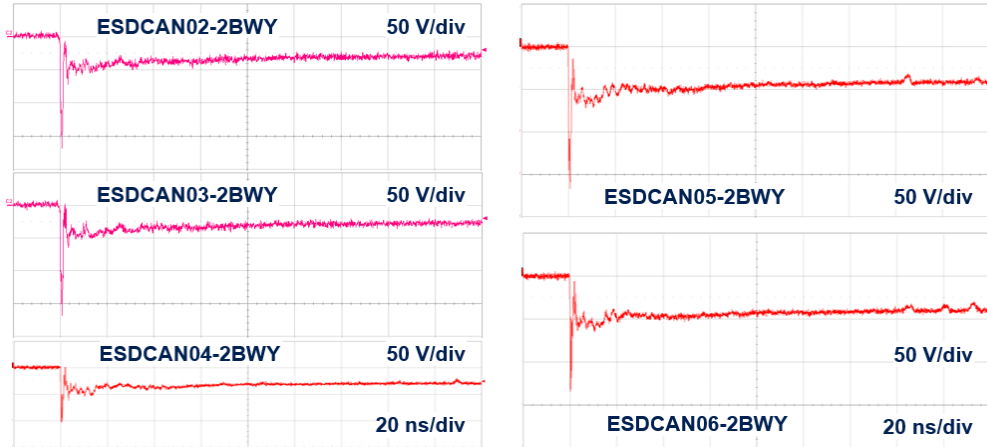
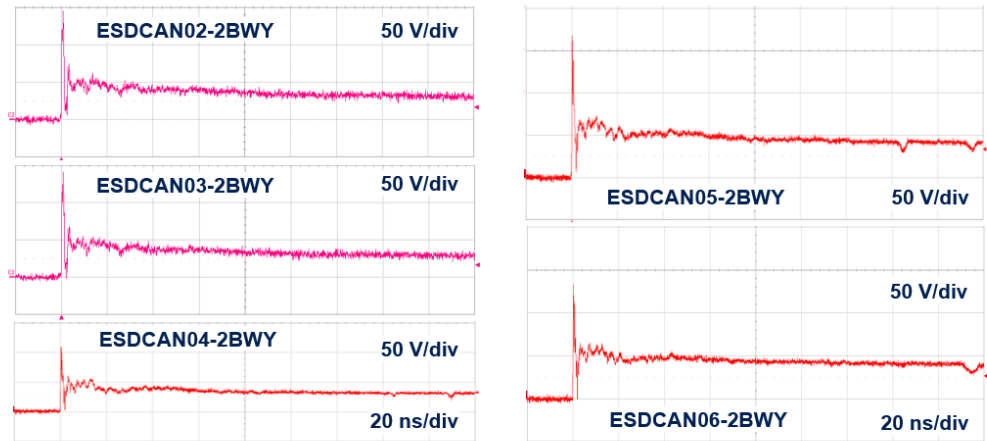
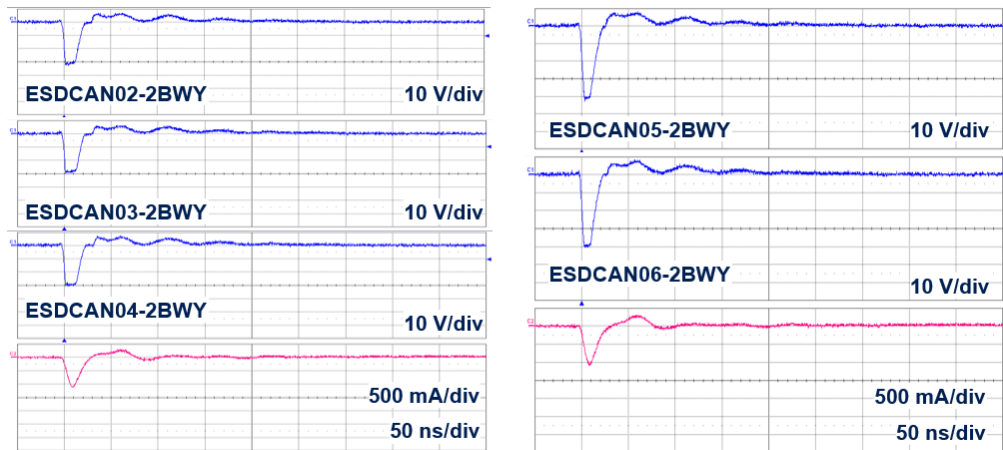
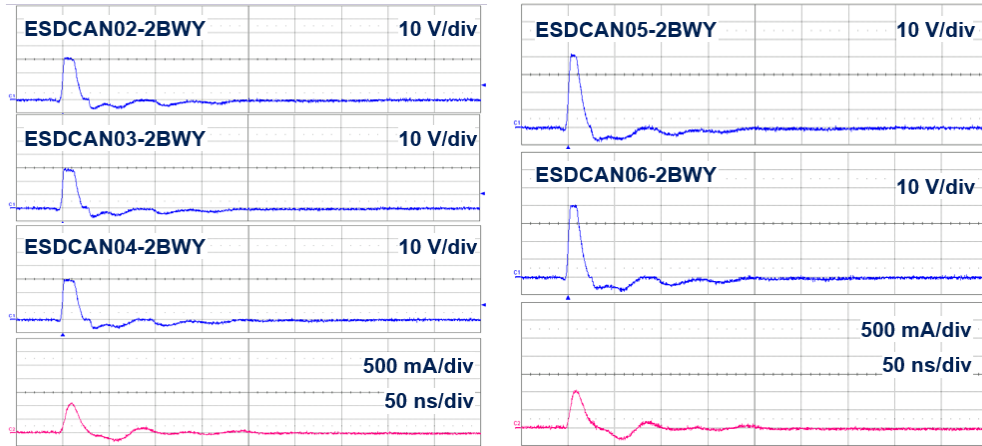

Figure 11. Response to ISO 7637-3 pulse 2a: -85 V

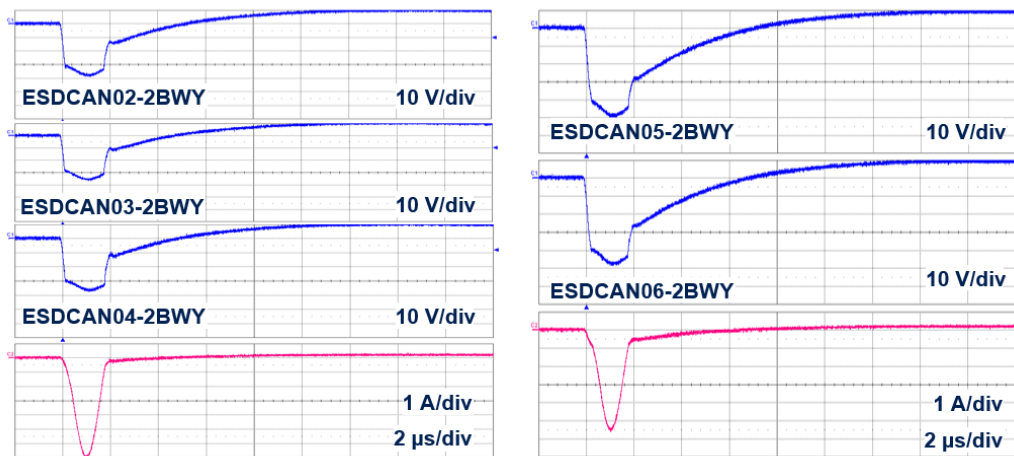

Figure 12. Response to ISO 7637-3 pulse 2a: +85 V

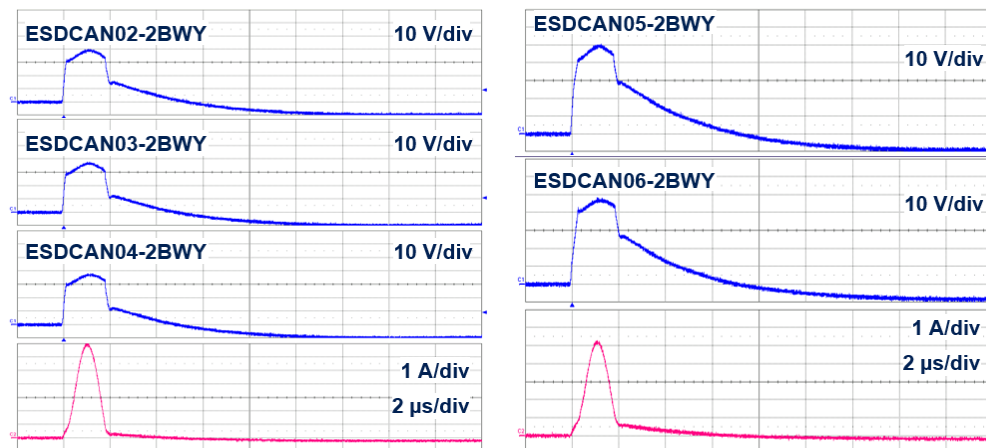

Figure 13. S21 attenuation

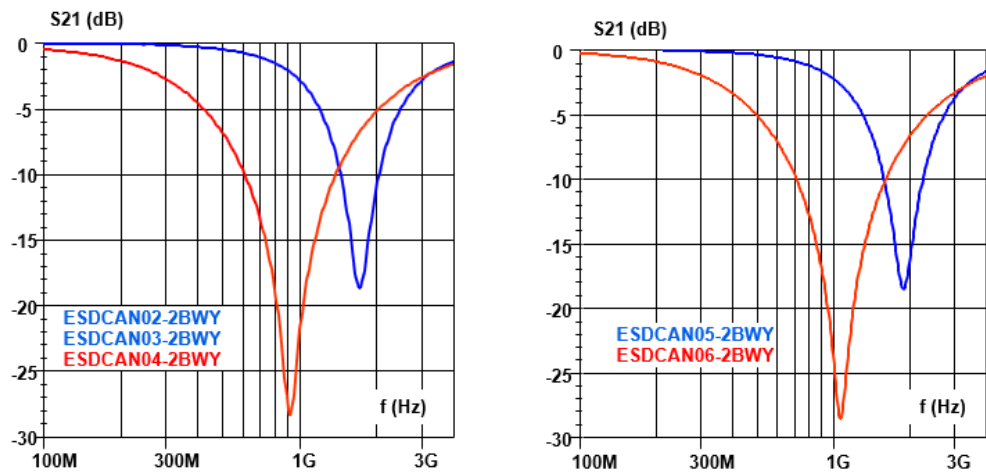
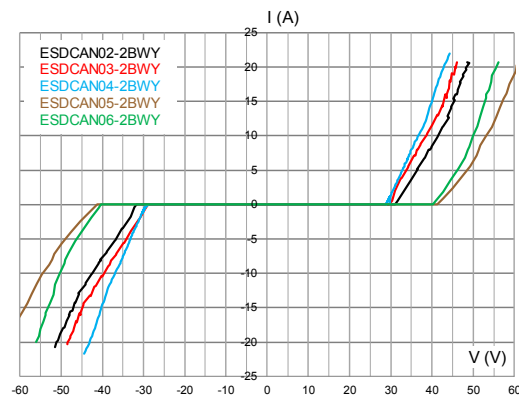

Figure 14. TLP



2 Package information

In order to meet environmental requirements, ST offers these devices in different grades of **ECOPACK®** packages, depending on their level of environmental compliance. ECOPACK® specifications, grade definitions and product status are available at: www.st.com. ECOPACK® is an ST trademark.

2.1 SOT323-3L package information

Figure 15. SOT323-3L package outline

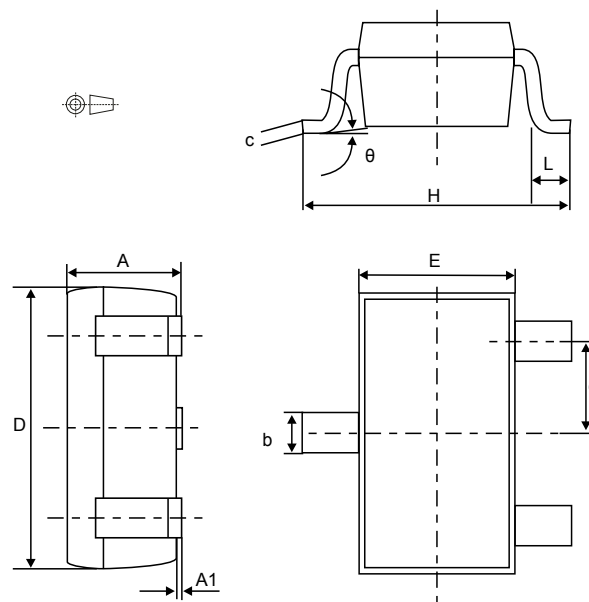
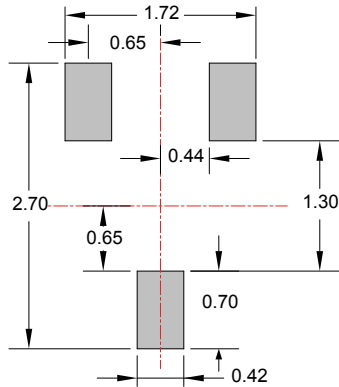
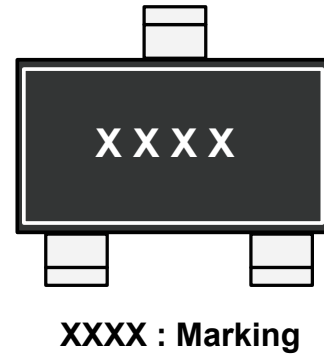
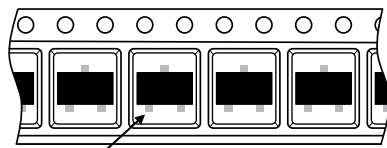

Table 3. SOT323-3L package mechanical data

Ref.	Dimensions					
	Millimeters			Inches ⁽¹⁾		
	Min.	Typ.	Max.	Min.	Typ.	Max.
A	0.80		1.10	0.031		0.044
A1	0.00		0.10	0.000		0.004
b	0.25		0.40	0.009		0.016
c	0.10		0.26	0.003		0.011
D	1.80	2.00	2.20	0.070	0.079	0.087
E	1.15	1.25	1.35	0.045	0.049	0.054
e	0.60	0.65	0.70	0.023	0.026	0.028
H	1.80	2.10	2.40	0.070	0.083	0.095
L	0.10	0.20	0.30	0.004	0.008	0.012
θ		0	30°		0	30°

1. Values in inches are converted from mm and rounded to 3 decimal digits

2.2 Packing information

Figure 16. SOT323-3L footprint in mm (inches)

Figure 17. SOT323-3L marking

Figure 18. Package orientation in reel

Pin 1 located according to EIA-481

Note: Pocket dimensions are not on scale
Pocket shape may vary depending on package

Figure 19. Tape and reel orientation

Figure 20. 7" reel dimension values

Figure 21. Inner box dimension values

Figure 22. Tape outline

Note: Pocket dimensions are not on scale
 Pocket shape may vary depending on package

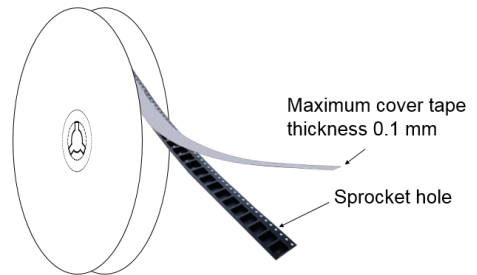
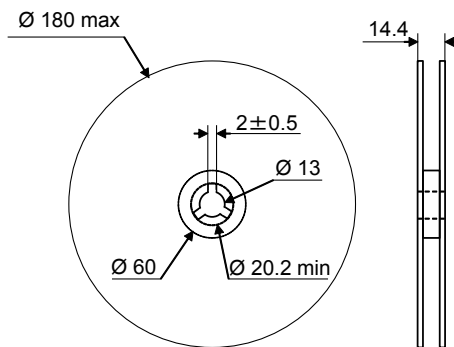
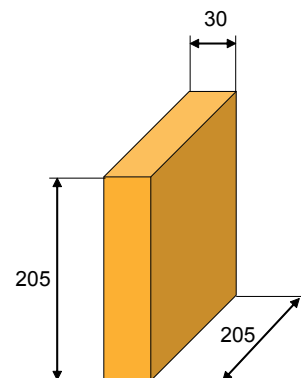
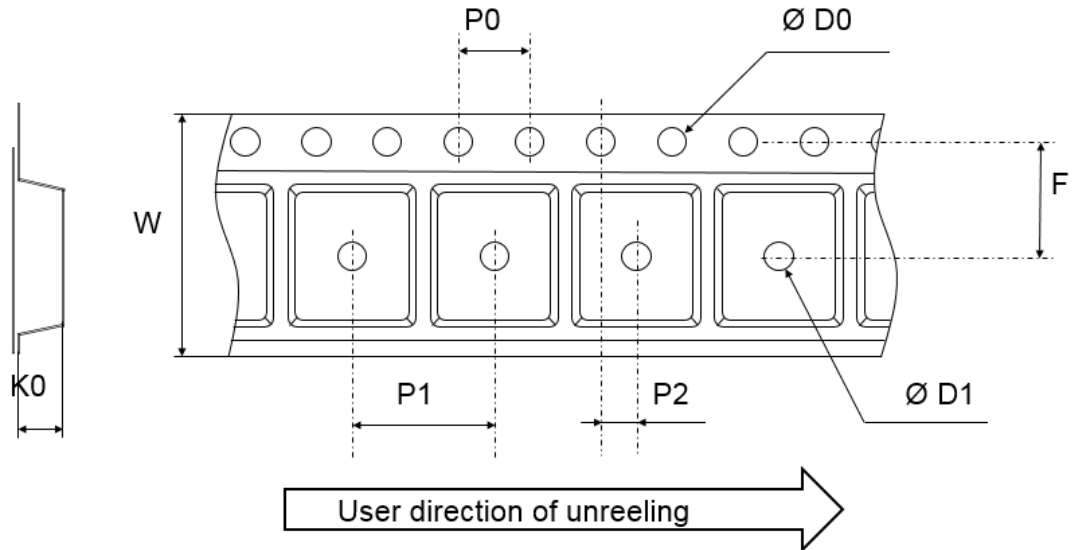
Table 4. Tape dimension values

Ref.	Dimensions		
	Millimeters		
	Min.	Typ.	Max.
D0	1.50	1.55	1.6
D1	1.00		
F	3.45	3.50	3.55
K0	1.12	1.22	1.32
P0	3.90	4.00	4.10
P1	3.90	4.00	4.10
P2	1.95	2.00	2.05
W	7.90	8.00	8.30

3 Reflow profile

Figure 23. ST ECOPACK® recommended soldering reflow profile for PCB mounting

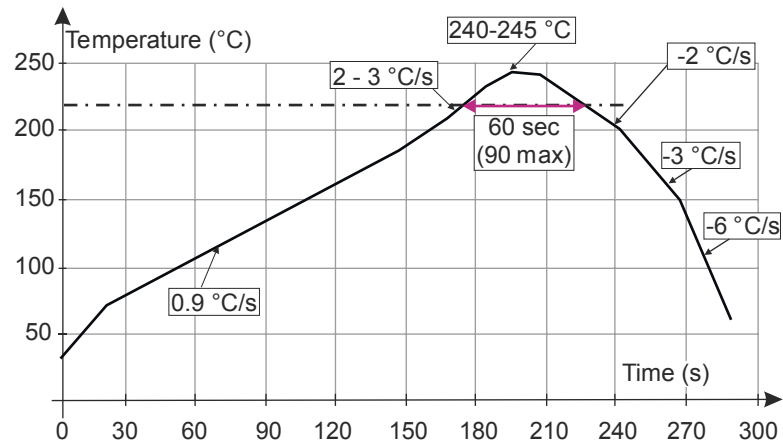

Note: Minimize air convection currents in the reflow oven to avoid component movement. Maximum soldering profile corresponds to the latest IPC/JEDEC J-STD-020.

4 Ordering information

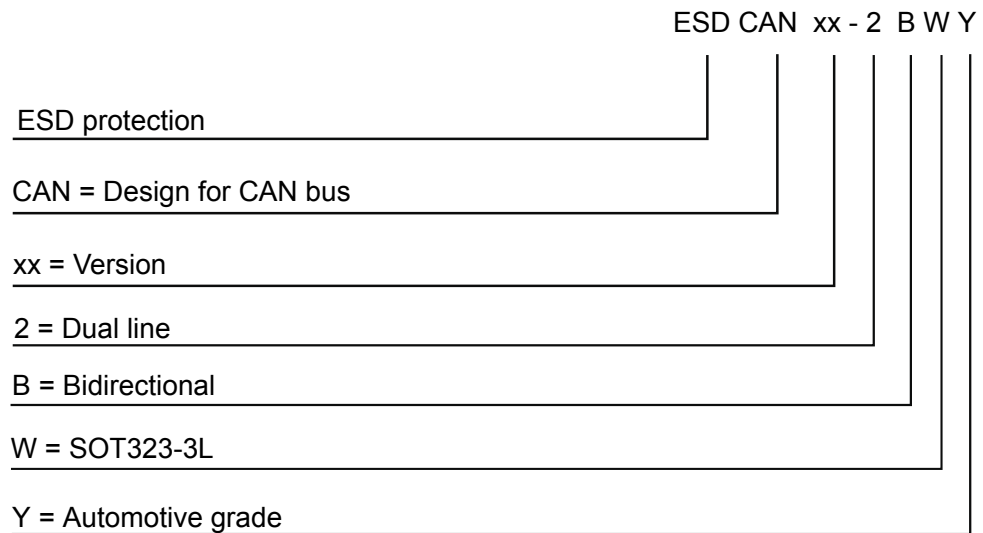
Figure 24. Ordering information scheme

Table 5. Ordering information

Order code	Marking ⁽¹⁾	Package	Weight	Base qty.	Delivery mode
ESDCAN02-2BWY	C02	SOT323-3L	6.58 mg	3000	Tape and reel
ESDCAN03-2BWY	C03				
ESDCAN04-2BWY	C04				
ESDCAN05-2BWY	C05				
ESDCAN06-2BWY	C06				

1. The marking can be rotated by multiples of 90° to differentiate assembly location

Revision history

Table 6. Document revision history

Date	Revision	Changes
17-Oct-2018	1	First issue.
13-Nov-2018	2	Updated product name on cover page.

IMPORTANT NOTICE – PLEASE READ CAREFULLY

STMicroelectronics NV and its subsidiaries (“ST”) reserve the right to make changes, corrections, enhancements, modifications, and improvements to ST products and/or to this document at any time without notice. Purchasers should obtain the latest relevant information on ST products before placing orders. ST products are sold pursuant to ST’s terms and conditions of sale in place at the time of order acknowledgement.

Purchasers are solely responsible for the choice, selection, and use of ST products and ST assumes no liability for application assistance or the design of Purchasers’ products.

No license, express or implied, to any intellectual property right is granted by ST herein.

Resale of ST products with provisions different from the information set forth herein shall void any warranty granted by ST for such product.

ST and the ST logo are trademarks of ST. All other product or service names are the property of their respective owners.

Information in this document supersedes and replaces information previously supplied in any prior versions of this document.

© 2018 STMicroelectronics – All rights reserved

Mouser Electronics

Authorized Distributor

Click to View Pricing, Inventory, Delivery & Lifecycle Information:

[STMicroelectronics:](#)

[ESDCAN03-2BWY](#) [ESDCAN02-2BWY](#) [ESDCAN05-2BWY](#) [ESDCAN06-2BWY](#) [ESDCAN04-2BWY](#)