

**500V N-CHANNEL ENHANCEMENT MODE MOSFET**

**MAIN CHARACTERISTICS**

<b>I<sub>D</sub></b>	45A
<b>V<sub>DSS</sub></b>	500V
<b>R<sub>DS(on)-typ(@V<sub>GS</sub>=10V)</sub></b>	<0.1Ω <b>(Type:0.08Ω)</b>

**Features**

- ◆Fast Switching
- ◆Low ON Resistance
- ◆Low Gate Charge
- ◆100% Single Pulse avalanche energy Test
- ◆LeadfreeincomplywithEUroHS2011/65/EUdirectives

**Mechanical Data**

- ◆Case: Molded plastic
- ◆Mounting Position: Any
- ◆Molded Plastic: UL Flammability Classification Rating 94V-0
- ◆Solder bath temperature275℃maximum,10s per JESD22-106

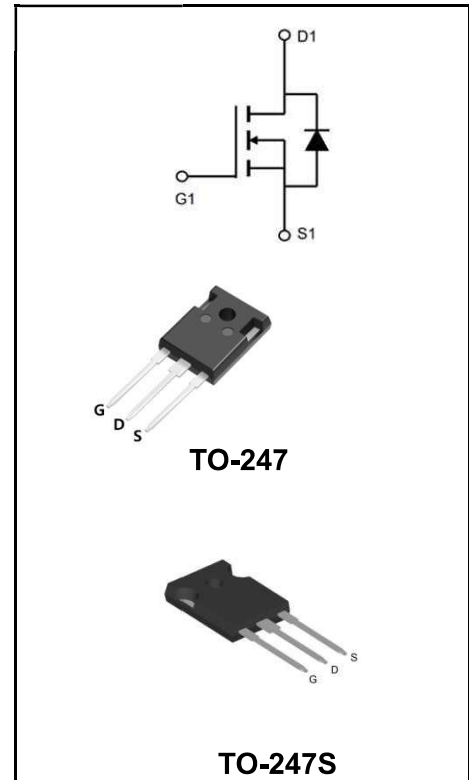

**Product Specification Classification**

Part Number	Package	Marking	Pack
YFW45N50AP	TO-247	YFW 45N50AP XXXXX	30PCS/Tube
YFW45N50APS	TO-247S	YFW 45N50APS XXXXX	30PCS/Tube

**Maximum Ratings at Tc=25°C unless otherwise specified**

Characteristics	Symbols	Value	Units
		247/247S	
Drain-Source Voltage	<b>V<sub>DS</sub></b>	500	<b>V</b>
Gate-Source Voltage	<b>V<sub>GS</sub></b>	±30	<b>V</b>
Continue Drain Current	<b>I<sub>D</sub></b>	45	<b>A</b>
-Continuous (TC = 100°C)		13	
Pulsed Drain Current (Note1)	<b>I<sub>DM</sub></b>	120	<b>A</b>
Power Dissipation	<b>P<sub>D</sub></b>	250	<b>W</b>
-Derate above 25°C		2.5	
Single Pulse Avalanche Energy (Note2)	<b>E<sub>AS</sub></b>	3000	<b>mJ</b>
Avalanche Current (Note 1)	<b>I<sub>AR</sub></b>	45	<b>A</b>
Repetitive Avalanche Energy (Note 1)	<b>E<sub>AS</sub></b>	38	<b>mJ</b>
Operating Temperature Range	<b>T<sub>J</sub></b>	150	<b>°C</b>
Storage Temperature Range	<b>T<sub>STG</sub></b>	-55 to +150	<b>°C</b>
Thermal Resistance, Junction to Case	<b>R<sub>θJC</sub></b>	0.51	<b>°C/W</b>
Thermal Resistance, Junction to Ambient	<b>R<sub>θJA</sub></b>	40	<b>°C/W</b>

**Maximum Ratings at Tc=25°C unless otherwise specified**

Characteristics	Test Condition	Symbols	Min	Typ	Max	Units
Drain-Source Breakdown Voltage	V <sub>GS</sub> = 0 V, I <sub>D</sub> = 250 μA	<b>BV<sub>DSS</sub></b>	500	-	-	<b>V</b>
Breakdown Voltage Temperature Coefficient	I <sub>D</sub> =250μA (Referenced to 25°C)	$\frac{\Delta BV_{DSS}}{\Delta T_J}$	-	0.6	-	<b>V/°C</b>
Drain-Source Leakage Current	V <sub>DS</sub> = 500 V, V <sub>GS</sub> = 0 V	<b>I<sub>DSS</sub></b>	-	-	1	<b>uA</b>
	V <sub>DS</sub> = 400 V, T <sub>c</sub> = 125°C		-	-	10	
Gate Leakage Current	V <sub>GS</sub> = ± 30 V, V <sub>DS</sub> = 0 V	<b>I<sub>GSS</sub></b>	-	-	±100	<b>nA</b>
Gate-Source Threshold Voltage	V <sub>DS</sub> = V <sub>GS</sub> , I <sub>D</sub> = 250 μA	<b>V<sub>GS(th)</sub></b>	3	-	5	<b>V</b>
Drain-Source On-State Resistance	V <sub>GS</sub> = 10 V, I <sub>D</sub> = 22.5A	<b>R<sub>DS(on)</sub></b>	-	0.08	0.1	<b>Ω</b>
Forward Transconductance	V <sub>DS</sub> = 15 V, I <sub>D</sub> = 22.5 A	<b>g<sub>fs</sub></b>	-	18	-	<b>S</b>
Input Capacitance	V <sub>GS</sub> = 0 V, V <sub>DS</sub> = 25 V, f = 1MHz	<b>C<sub>iss</sub></b>	-	7453	-	<b>pF</b>
Output Capacitance		<b>C<sub>OSS</sub></b>	-	721	-	
Reverse Transfer Capacitance		<b>C<sub>rss</sub></b>	-	28	-	
Turn-on Delay Time	I <sub>D</sub> = 45, V <sub>DD</sub> = 250V, R <sub>G</sub> =10Ω(Note3,4)	<b>td(ON)</b>	-	67	-	<b>nS</b>
Rise Time		<b>tr</b>	-	144	-	
Turn-Off Delay Time		<b>td(OFF)</b>	-	211	-	
Fall Time		<b>tf</b>	-	96	-	
Total Gate Charge	I <sub>D</sub> =45 A, V <sub>DD</sub> = 400 V, V <sub>GS</sub> = 10 V(Note3,4)	<b>Q<sub>G</sub></b>	-	196	-	<b>nC</b>
Gate to Source Charge		<b>Q<sub>GS</sub></b>	-	38	-	
Gate to Drain Charge		<b>Q<sub>GD</sub></b>	-	55	-	

**Source-Drain Diode Characteristics at Ta=25°C unless otherwise specified**

Characteristics	Test Condition	Symbols	Min	Typ	Max	Units
Maximun Body-Diode Continuous Current		<b>I<sub>S</sub></b>	-	-	30	<b>A</b>
Maximun Body-Diode Pulsed Current		<b>I<sub>SM</sub></b>	-	-	120	<b>A</b>
Drain-Source Diode Forward Voltage	<b>I<sub>SD</sub></b> =45A	<b>V<sub>SD</sub></b>	-	-	1.4	<b>V</b>
Reverse Recovery Time	<b>I<sub>SD</sub></b> = 45A, <b>V<sub>GS</sub></b> = 0 V, <b>dI<sub>F</sub> / dt</b> = 100 A/μs(Note3)	<b>trr</b>	-	482	-	<b>nS</b>
Reverse Recovery Charge		<b>Qrr</b>	-	8.4	-	<b>uC</b>

Note:

1. Repetitive Rating: Pulse width limited by maximum junction temperature.
2. **I<sub>AS</sub>** = 45 A, **V<sub>DD</sub>** = 50 V, **L** = 3 mH, **R<sub>G</sub>** = 25Ω, starting **T<sub>J</sub>** = 25°C.
3. ulse test: Pulse Width ≤300 μ s, Duty Cycle≤2%.
4. Essentially Independent of Operating Temperature.

Ratings and Characteristic Curves

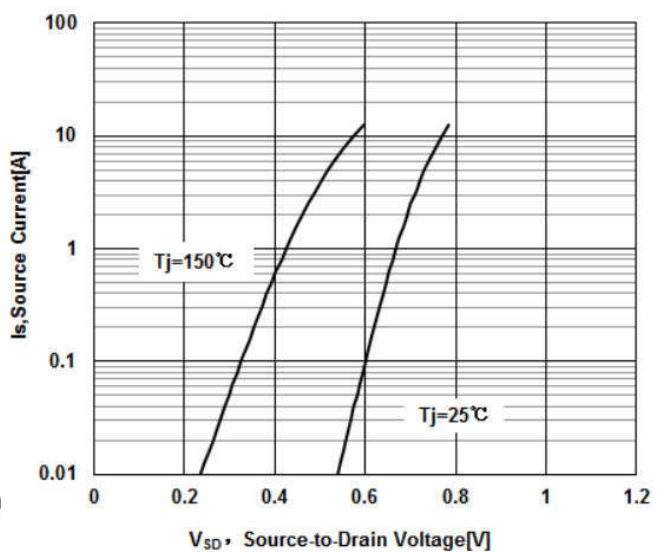
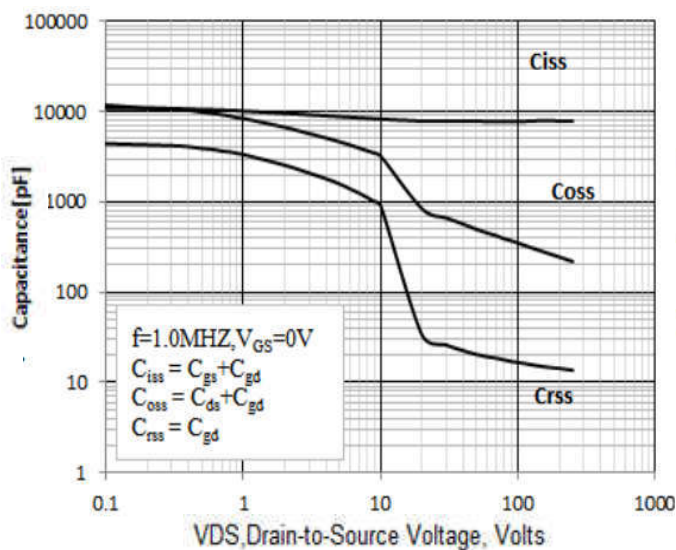
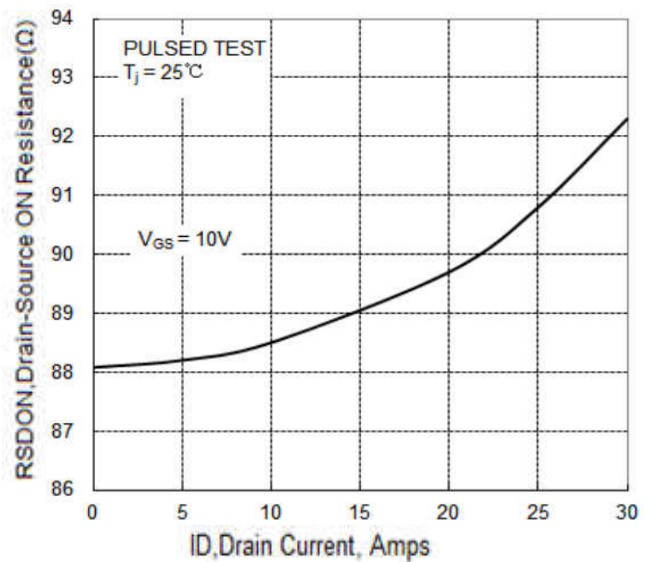
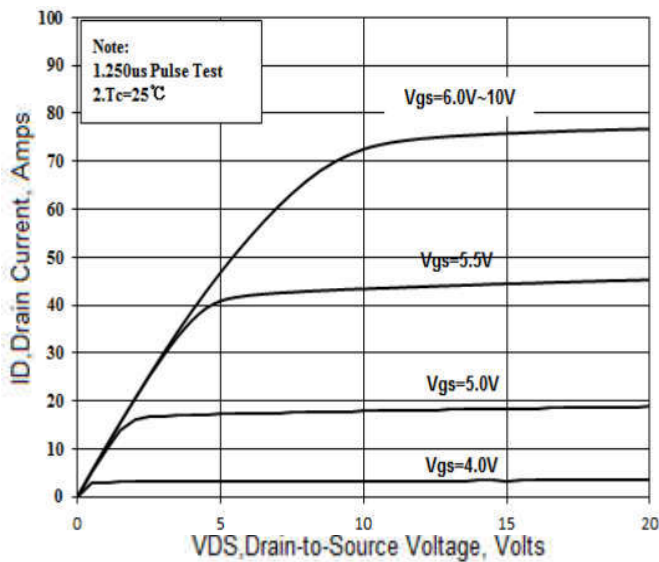
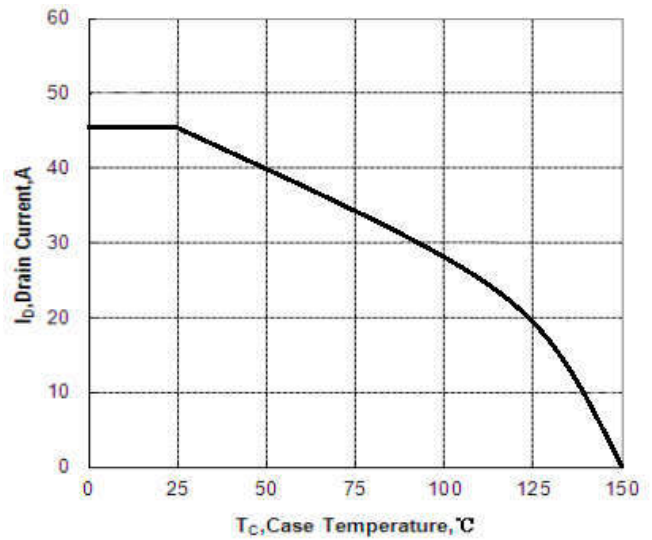
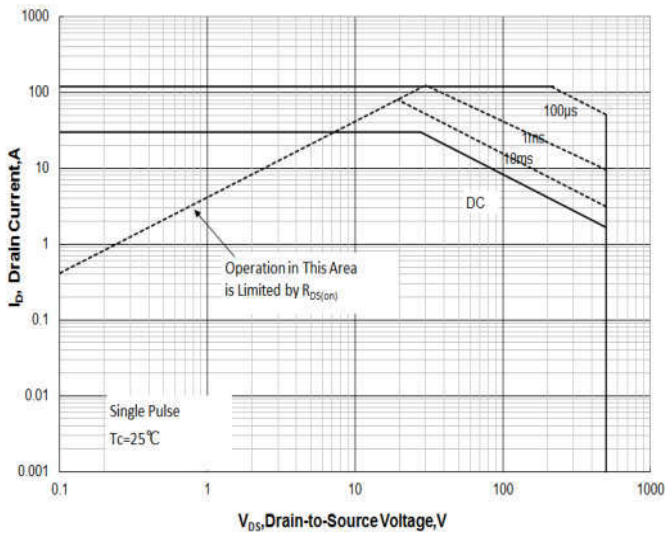

Package Outline Dimensions millimeters

TO-247

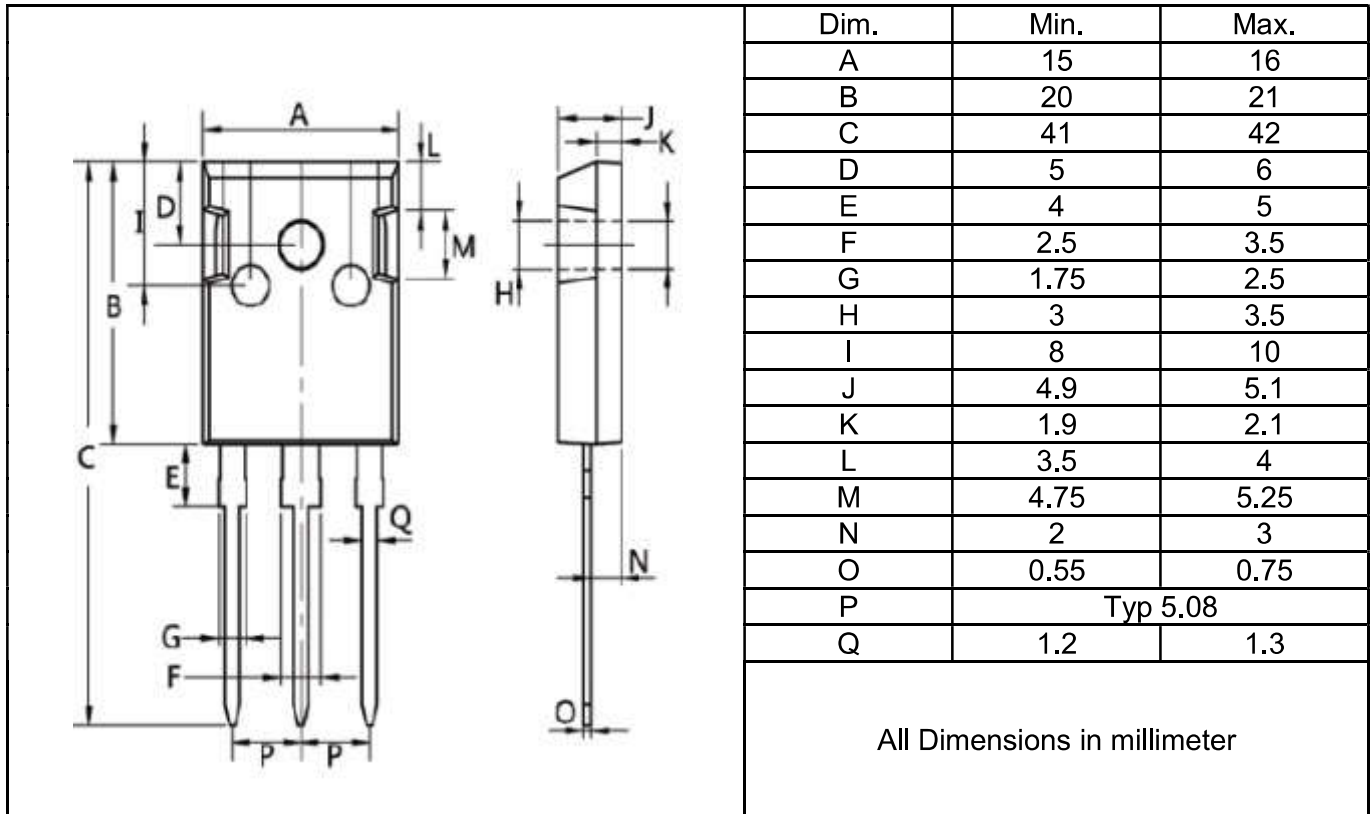

TO-247S

