

Toggles
A General Specifications

Rockers

Pushbuttons

Illuminated PB

Programmable

Keylocks

Rotaries

Slides

Tactiles

Tilt

Touch

Indicators

Accessories

Supplement

Electrical Capacity (Resistive Load)

Power Level (silver): Maximum rating varies by model number
MN11, MN12, MN21, MN22: 6A @ 125V AC, 3A @ 250V AC, 4A @ 30V DC
MN13, MN15, MN18, MN19, MN23, MN25: 6A @ 125V AC, 3A @ 250V AC, 3A @ 30V DC
MN28, MN29: 4A @ 125V AC, 3A @ 250V AC, 3A @ 30V DC
MN32, MN42: 4A @ 125V AC, 2A @ 250V AC, 3A @ 30V DC
MN33, MN35, MN38, MN39: 4A @ 125V AC, 2A @ 250V AC, 2A @ 30V DC
MN43, MN45, MN48, MN49: 4A @ 125V AC, 2A @ 250V AC, 2A @ 30V DC
MN24, MN26, MN27, MN44, MN46, MN47: 3A @ 125V AC, 2A @ 250V AC, 2A @ 30V DC
 Recommended minimum voltage/current: 0.1A @ 2V AC/DC
Logic Level (gold): 0.4VA maximum @ 28V AC/DC maximum (Applicable Range 0.1mA ~ 0.1A @ 20mV ~ 28V)

Other Ratings

Contact Resistance: 10 milliohms maximum for silver; 20 milliohms maximum for gold
Insulation Resistance: 1,000 megohms minimum @ 500V DC
Dielectric Strength: 1,000V AC minimum between contacts for 1 minute minimum;
 1,500V AC minimum between contacts and case for 1 minute minimum
Mechanical Life: 50,000 operations minimum
Electrical Life: 25,000 operations minimum for silver; 50,000 operations minimum for gold
Angle of Throw: 25°

Materials & Finishes

Toggle: Brass with chrome plating **Frame:** Stainless steel
Bushing: Brass with nickel plating **Support Bracket:** Brass with tin plating
Case: Diallyl phthalate resin (UL94V-0)
Movable Contactor: Phosphor bronze with silver plating or silver/silver alloy with no plating (code W) or phosphor bronze or copper with gold plating (code G)
Movable Contacts: Silver alloy (code W); copper with gold plating (code G)
Stationary Contacts: Silver alloy with silver plating (code W); copper or brass with gold plating (code G)
Terminals: Copper or brass with silver plating; or copper or brass with gold plating

Environmental Data

Operating Temperature Range: -30°C through +85°C (-22°F through +185°F)
Humidity: 90 ~ 95% humidity for 240 hours @ 40°C (104°F)
Vibration: 10 ~ 55Hz with peak-to-peak amplitude of 1.5mm traversing the frequency range & returning in 1 minute; 3 right angled directions for 2 hours
Shock: 500m/s² acceleration (tested in 6 right angled directions, with 5 shocks in each direction)
Sealing: Splashproof bushing options B3, D3, D8, L3, & L8, which have o-rings inside & outside the bushing, meet IP67 of IEC60529 Standards.

Installation

Mounting Torque: 3.0Nm (26.55 lb•in) double nut for large bushing;
 1.5Nm (13 lb•in) double nut & 0.7Nm (6 lb•in) single nut for all other bushings

Processing

Soldering: Wave Soldering (PC version) for Gold: See Profile A in Supplement section.
 Manual Soldering for Gold: See Profile A in Supplement section.
 Wave Soldering (PC version) for Silver: See Profile B in Supplement section.
 Manual Soldering for Silver: See Profile B in Supplement section.
 Note: Lever must be in OFF (center) position while soldering.
Cleaning: These devices are not process sealed. Hand clean locally using alcohol based solution.

Standards & Certifications

Flammability Standards: UL94V-0 for case
UL: Contact NKK Switches for UL or CUL marking option requirements.

Distinctive Characteristics

Antirotaion design, standard on noncylindrical levers, mates toggle and bushing; bottom of toggle has two flattened sides which fit into a complementary opening inside bushing.

Antijamming design protects contacts from damage due to excessive downward force on actuator.

High torque bushing construction prevents rotation or separation from frame during installation.

High insulating barriers increase isolation of circuits in multiple devices and provide added protection to contact points.

Molded diallyl phthalate case has a UL flammability rating of 94V-0.

Epoxy sealed terminals prevent entry of solder flux and other contaminants.

Prominent external insulating barriers increase insulation resistance and dielectric strength.

Interlocked actuator block, lever, and interior guide prevent switch failure due to biased lever movement.

Clinching of frame to case well above base and terminals provides 1,500V dielectric strength.

Special silver alloy contacts with excellent wear resistance and arc resistance maintain high contact stability and long life.

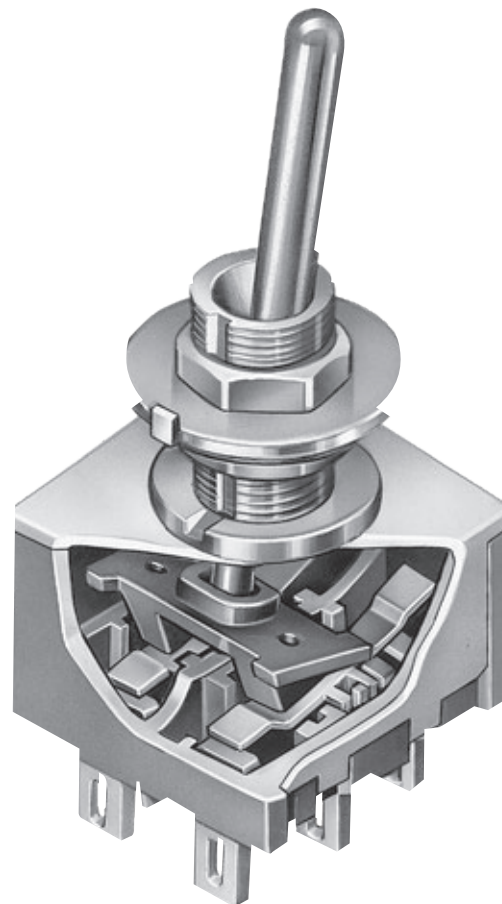

Actual Size

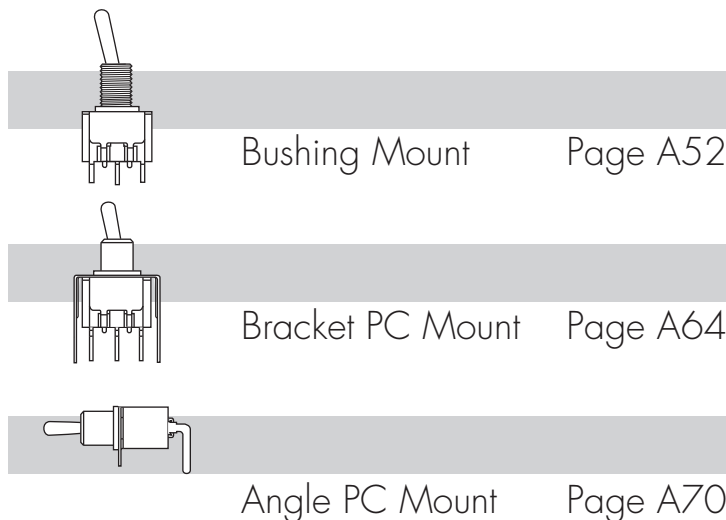
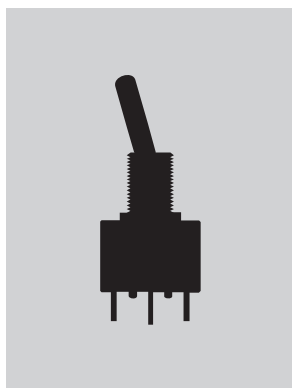

- A Toggles
- Rockers
- Pushbuttons
- Illuminated PB
- Programmable
- Keylocks
- Rotaries
- Slides
- Tactiles
- Tilt
- Touch
- Indicators
- Accessories
- Supplement

Toggles
A

Rockers

Pushbuttons

Programmable Illuminated PB

Keylocks

Rotaries

Slides

Tactiles

Tilt

Touch

Indicators

Accessories

Supplement



Poles	
1	SPST SPDT
2	DPST DPDT SP3T
3	3PDT
4	4PDT DP3T

Circuits			
* 1	ON	NONE	OFF
2	ON	NONE	ON
3	ON	OFF	ON
5	ON	NONE	(ON)
8	(ON)	OFF	(ON)
9	ON	OFF	(ON)
** 4	ON	ON	ON
** 6	(ON)	ON	(ON)
** 7	ON	ON	(ON)

NONE = No Position

() = Momentary

* ON-NONE-OFF circuit available in 1- and 2-pole only.

** 3-ON circuits

Small Toggles	
S	.413" (10.5mm) Bat
S2	.200" (5.08mm) Bat
S3	.256" (6.5mm) Bat
E	.450" (11.4mm) Flatted
*E2	.256" (6.5mm) Flatted

*Available on 1- and 2-pole only

Large Toggles	
B	.453" (11.5mm) Large Bat
B2	.689" (17.5mm) Large Bat

Locking Lever	
L	.201" (5.1mm) Dia. Locking Lever

Small Bushings	
*S1	.350" (8.9mm) Threaded with Keyway
**S4	6mm .350" (8.9mm) Threaded with Keyway
***S2	.350" (8.9mm) Smooth with Keyway
****D3	.350" (8.9mm) Threaded Splashproof with D Flat (combines only with S, S2 & S3)
**D8	6mm .350" (8.9mm) Threaded Splashproof with D Flat (combines only with S, S2 & S3)

* 01 & 06 Terminals Only
 ** 01 & 03 Terminals Only
 *** 03 Terminal Only
 **** 01 Terminal Only

Large Bushings	
**B1	Large .472" (12.0mm) Threaded with Keyway
****B3	Large .472" (12.0mm) Threaded Splashproof with D Flat

** 01 & 03 Terminals Only
 **** 01 Terminal Only

Bushings For Locking Levers	
*L1	.291" (7.4mm) Threaded with Keyway for Lever Lock
**L4	6mm .291" (7.4mm) Threaded with Keyway for Lever Lock
***L2	Smooth with Keyway for Lever Lock
****L3	.295" (7.5mm) Threaded Splashproof with D Flat for Lever Lock

* 01 & 06 Terminals Only
 ** 01 & 03 Terminals Only
 *** 03 Terminal Only
 **** 01 Terminal Only

ORDERING EXAMPLE

Contact Materials & Ratings	
W	Silver; Rated 2 ~ 6A @ 125V AC & 2 ~ 3A @ 250V AC
G	Gold; Rated 0.4VA max @ 28V AC/DC max

Terminals	
*01	Solder Lug
**03	.250" (6.35mm) Straight PC
***06	.750" (19.05mm) Wirewrap

* Combines with Threaded Bushings Only
 ** Combines with S4, S2, D8, L4 & L2 Bushings Only
 *** Combines with S1 Bushing Only

Optional Caps	
For Small Bat Toggles	
B	For S Bat Toggle
C	Conical Cap for S Bat Toggle
For Large Bat Toggles	
R	For B Toggle
V	For B2 Toggle

Cap for Locking Lever	
No Code	Nickel Plated Supplied with Switch
A	Black
C	Red
G	Blue







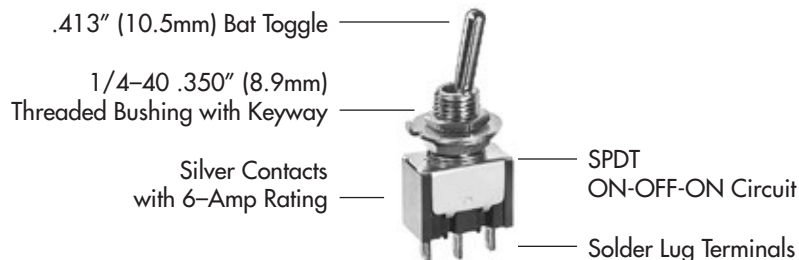

Cap Colors	
A	Black
B	White
C	Red
E	Yellow
F	Green
G	Blue

DESCRIPTION FOR TYPICAL ORDERING EXAMPLE

MN13SS1W01

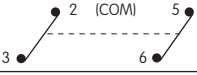
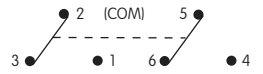
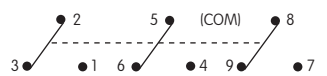
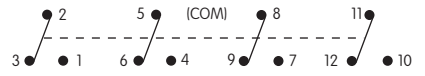

POLES & CIRCUITS

		Toggle Position			Connected Terminals			Throw & Schematics	
		NONE = No Position () = Momentary							
Pole	Model	Down 	Center 	Up 	Down 	Center 	Up 	Note: Terminal numbers are not actually on the switch.	
SP	MN11	ON	NONE	OFF	2-3	OPEN	OPEN	SPST	
	MN12	ON	NONE	ON	2-3	OPEN	2-1	SPDT	
	MN13	ON	OFF	ON					
	MN15	ON	NONE	(ON)					
	MN18	(ON)	OFF	(ON)					
MN19	ON	OFF	(ON)						
DP	MN21	ON	NONE	OFF	2-3 5-6	OPEN	OPEN	DPST	
	MN22	ON	NONE	ON	2-3 5-6	OPEN	2-1 5-4	DPDT	
	MN23	ON	OFF	ON					
	MN25	ON	NONE	(ON)					
	MN28	(ON)	OFF	(ON)					
MN29	ON	OFF	(ON)						
3P	MN32	ON	NONE	ON	2-3 5-6 8-9	OPEN	2-1 5-4 8-7	3PDT	
	MN33	ON	OFF	ON					
	MN35	ON	NONE	(ON)					
	MN38	(ON)	OFF	(ON)					
	MN39	ON	OFF	(ON)					
4P	MN42	ON	NONE	ON	2-3 5-6 8-9 11-12	OPEN	2-1 5-4 8-7 11-10	4PDT	
	MN43	ON	OFF	ON					
	MN45	ON	NONE	(ON)					
	MN48	(ON)	OFF	(ON)					
	MN49	ON	OFF	(ON)					

For 3 Throw (3-On)

Connected Terminals & Schematic

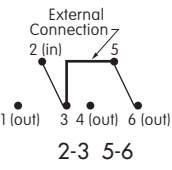
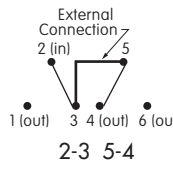
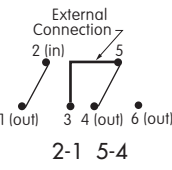
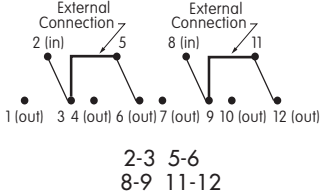
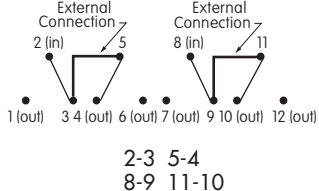
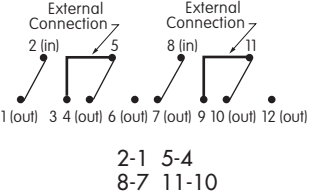
Pole	Model	Down	Center	Up	Down	Center	Up
SP	MN24	ON	ON	ON			
	MN26	(ON)	ON	(ON)			
	MN27	ON	ON	(ON)			
DP	MN44	ON	ON	ON			
	MN46	(ON)	ON	(ON)			
	MN47	ON	ON	(ON)			

The SP3T model utilizes a double pole base.

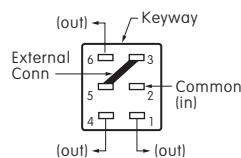

External connection must be made during field installation.

The DP3T model utilizes a four pole base.

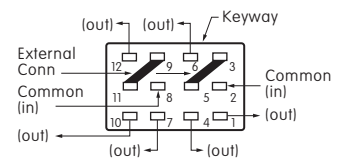

External connection must be made during field installation.

SMALL TOGGLES

A Toggles

Important:

Toggle length changes based on bushing selected. All illustrations are shown with .350" long bushing. When using a .280" long bushing, toggle length increases .070".

S .413" (10.5mm) Bat

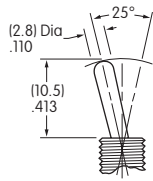

S2 .200" (5.08mm) Bat

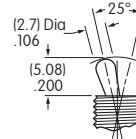

S3 .256" (6.5mm) Bat

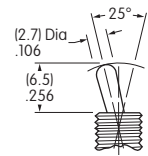

Standard Material & Finish: Brass with Bright Chrome
Contact factory for optional finishes.

E .450" (11.4mm) Flatted

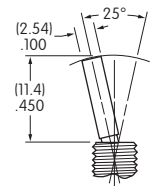
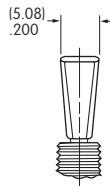

E2 .256" (6.5mm) Flatted

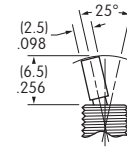
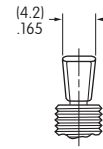

SMALL BUSHINGS

S1 1/4-40 .350" (8.9mm) Threaded with Keyway

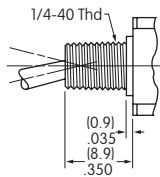
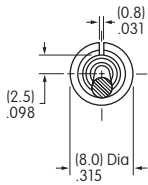

S4 6mm/.350" (8.9mm) Threaded with Keyway

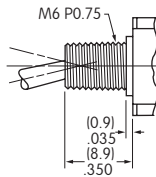
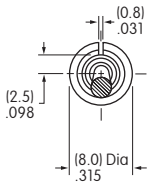

S2 .350" (8.9mm) Smooth with Keyway

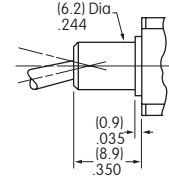
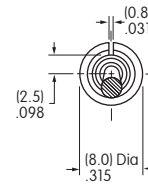

Maximum Panel Thickness with Standard Hardware: .102" (2.6mm)

Maximum Panel Thickness with Standard Hardware: .102" (2.6mm)

D3 1/4-40 .350" (8.9mm) Threaded Splashproof with D Flat

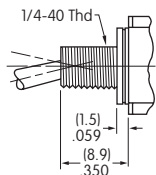
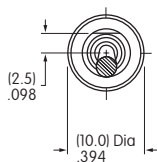

D8 6mm/.350" (8.9mm) Threaded Splashproof with D Flat

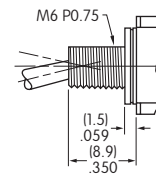
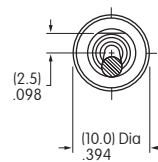

D3 combines only with S, S2 & S3 toggles. Maximum Panel Thickness with Standard Hardware: .193" (4.9mm)

D8 combines only with S, S2 & S3 toggles. Maximum Panel Thickness with Standard Hardware: .193" (4.9mm)

Standard Hardware Supplied for Small Bushings

Hardware and Quantity	Bushing Codes	S1/S4	D3/D8	L1/L4	L3
	Hex Nut		2	1	2
Locking Ring		1	0	1	0
Lockwasher		1	0	1	0
O-ring		0	1	0	1

Rockers

Pushbuttons

Illuminated PB

Programmable

Keylocks

Rotaries

Slides

Tactiles

Tilt

Touch

Indicators

Accessories

Supplement

Toggles **A**

For S1, S2 Bushing with Keyway & for L1 Bushing

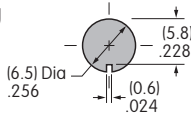

For S1 Bushing with Locking Ring & for L1 Bushing

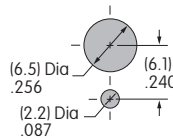

For S4 Bushing with Keyway & for L4 Bushing

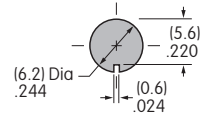

For S4 Bushing with Locking Ring & for L4 Bushing

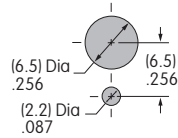

For D3 or D8 Bushing with D Flat & for L3 Bushing

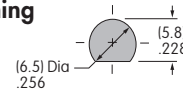

Rockers

Pushbuttons

PB

Illuminated

Programmable

Keylocks

Rotaries

Slides

Tactiles

Tilt

Touch

Indicators

Accessories

Supplement

LARGE TOGGLES

Toggle & Bushing Combinations: These toggles combine with the 12mm bushings B1 & B3.

B .453" (11.5mm) Large Bar

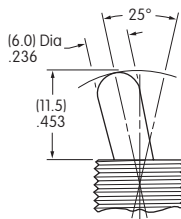

B2 .689" (17.5mm) Large Bar

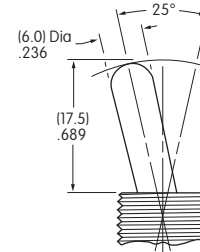

Standard Material & Finish: Brass with Bright Chrome
Optional Finishes: Contact factory for satin chrome or black.

LARGE BUSHINGS

B1 Large .472" (12.0mm) Threaded with Keyway

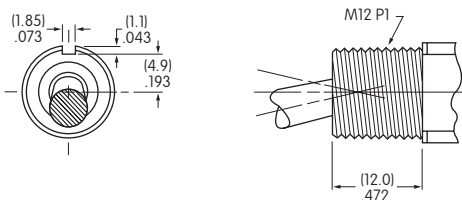

Maximum Panel Thickness with Standard Hardware: .216" (5.5mm)

Standard Hardware for B1:
1 hex face nut AT503M, 1 locking ring AT506M, 1 lockwasher AT508, and 1 hex backup nut AT527M

B3 Large .472" (12.0mm) Threaded Splashproof with D Flat

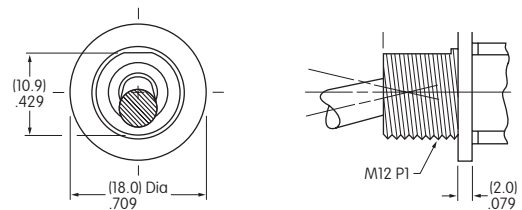

Maximum Panel Thickness with Standard Hardware: .256" (6.5mm)

Standard Hardware for B3:
1 hex face nut AT503M and 1 o-ring AT401P

Panel Cutouts

For B1 Bushing with Keyway

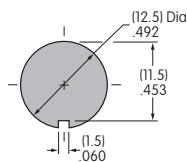

For B1 Bushing with Locking Ring

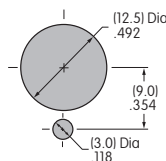

For B3 Bushing with D Flat

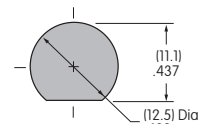

LOCKING LEVER & BUSHINGS

LL1 1/4-40 .291" (7.4mm)
Threaded with Keyway

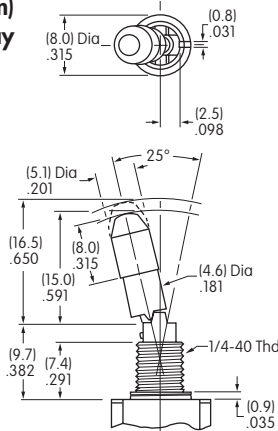

LL4 6mm/.291" (7.4mm)
Threaded with Keyway

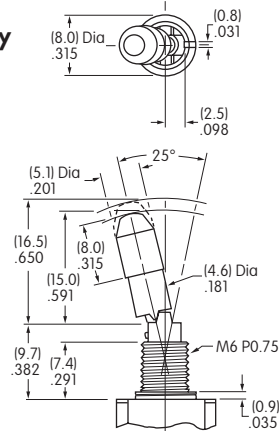

Maximum Panel Thickness with Standard Hardware: .047" (1.2mm)
Standard Hardware for L1 & L4: 2 hex nuts AT513H or AT513M,
1 locking ring AT507H or AT507M, and 1 lockwasher AT509

LL2 Smooth with Keyway

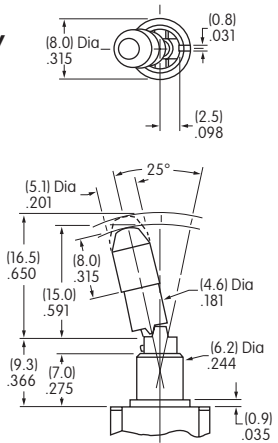

LL3 1/4-40 .295" (7.5mm)
Threaded Splashproof
with D Flat

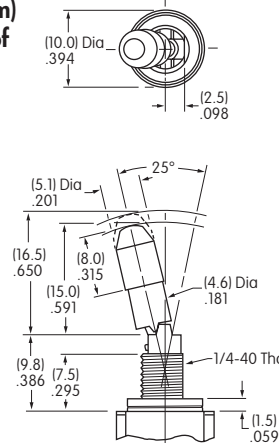

Maximum Panel Thickness with Standard Hardware: .047" (1.2mm)
Standard Hardware: 1 hex nut AT513H and 1 o-ring AT516

Lever Material & Finish: Brass with Chrome Plating

Locking Mechanism

on-none-on

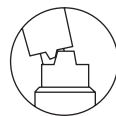

2 positions lock

on-none-(on)



1 position locks

on-off-(on)
on-on-(on)



2 positions lock

on-off-on
on-on-on

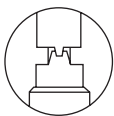

3 positions lock

(on)-off-(on)
(on)-on-(on)

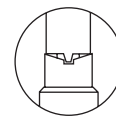

1 position locks

No Code

Supplied with Cap AT427

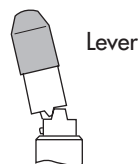

Cap Material:
Brass with Nickel Plating

Color Codes for Optional Anodized Aluminum Caps

A Black

C Red

G Blue

CONTACT MATERIALS & RATINGS

W

**Silver
Power Levels**

MN11, MN12, MN21, MN22: 6A @ 125V AC, 3A @ 250V AC, 4A @ 30V DC
MN13, MN15, MN18, MN19, MN23, MN25: 6A @ 125V AC, 3A @ 250V AC, 3A @ 30V DC
MN28, MN29: 4A @ 125V AC, 3A @ 250V AC, 3A @ 30V DC
MN32, MN42: 4A @ 125V AC, 2A @ 250V AC, 3A @ 30V DC
MN33, MN35, MN38, MN39: 4A @ 125V AC, 2A @ 250V AC, 2A @ 30V DC
MN43, MN45, MN48, MN49: 4A @ 125V AC, 2A @ 250V AC, 2A @ 30V DC
MN24, MN26, MN27, MN44, MN46, MN47: 3A @ 125V AC, 2A @ 250V AC, 2A @ 30V DC

G

Gold

Logic Level

0.4VA maximum @ 28V AC/DC maximum

Note: See Supplement section to find complete explanation of operating range.

Gold over Silver

**Power Level
or Logic Level**

See above for ratings

Note: Gold over silver is available as a custom option. This dual rated option is suitable when two or more identical switches are used in logic and in power circuits within the same application. See Supplement section to find complete explanation of dual rating and operating range.

TERMINALS

01

Solder Lug

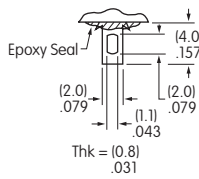

03

**.250" (6.35mm)
Straight PC**

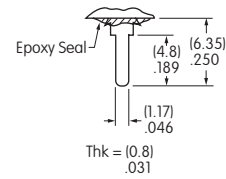

**Footprints for
Straight PC
Terminals**

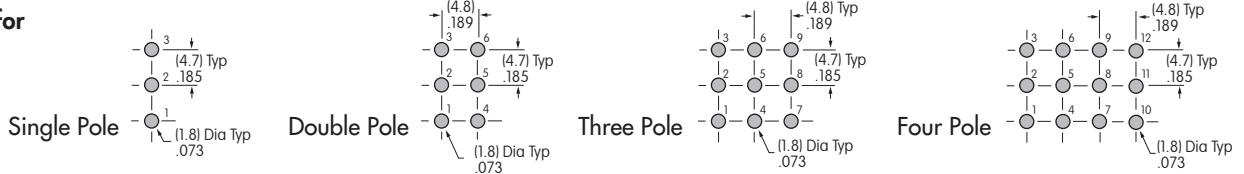

06

**.750" (19.05mm)
Wirewrap or Extended PC**

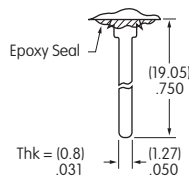

If using as extended PC terminal, refer to the footprints above.

OPTIONAL CAPS & CAP COLORS

B

*** AT415 Lever Cap
for S Bat Toggle**

Material: Polyethylene

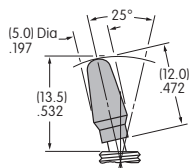

C

*** AT444 Conical Cap
for S Bat Toggle**

Material: Polyethylene

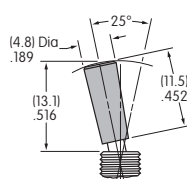

R

**AT434 Lever Cap
for B Toggle**

Material: Polyvinyl Chloride

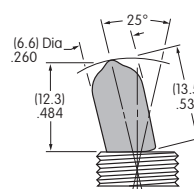

V

**AT406 Lever Cap
for B2 Toggle**

Material: Polyvinyl Chloride

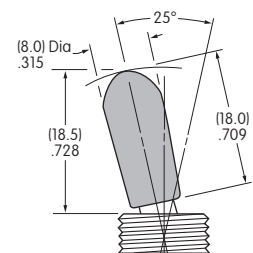

* AT415 and AT444 for use with S toggles only, not S2 or S3 toggles.

**Cap Colors
Available:**

A

Black

B

White

C

Red

E

Yellow

F

Green

G

Blue

TYPICAL SWITCH DIMENSIONS

Single Pole

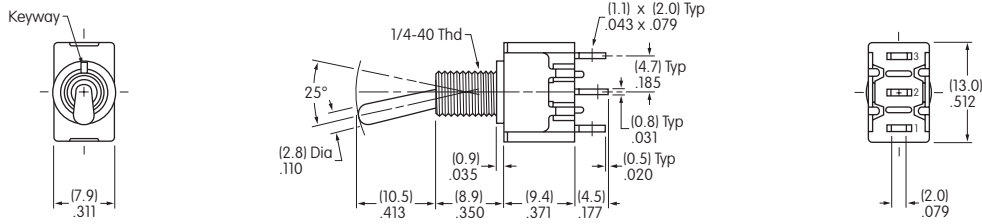

MN11 model does not have terminal 1.

Solder Lug



MN12SS1W01

Double Pole

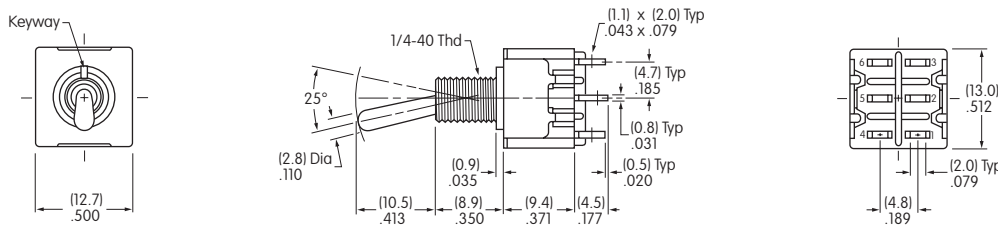

MN21 model does not have terminals 1 & 4.

Solder Lug



MN22SS1W01

Three Pole

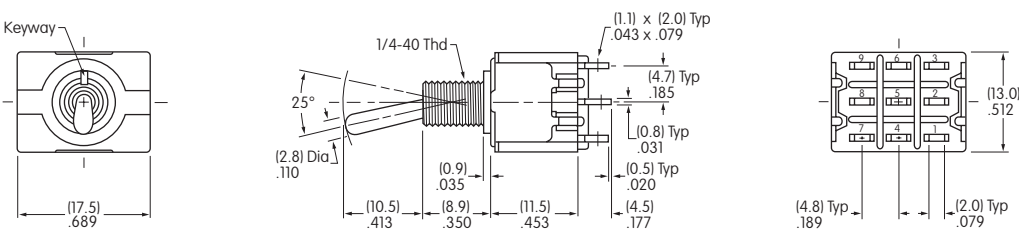

MN32SS1W01

Solder Lug



Four Pole

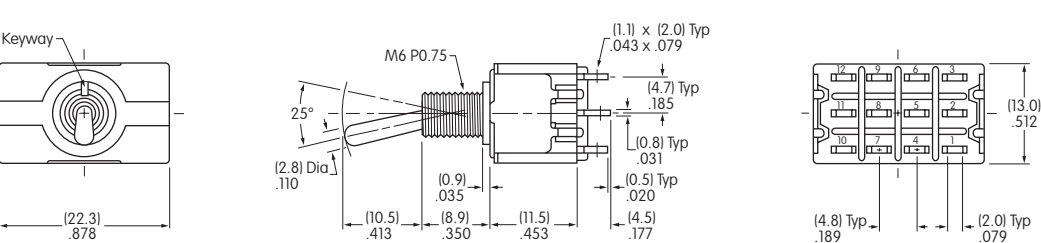

MN42SS4W01

Solder Lug



A Toggles

Rockers

Pushbuttons

Illuminated PB

Programmable

Keylocks

Rotaries

Slides

Tactiles

Tilt

Touch

Indicators

Accessories

Supplement

STANDARD HARDWARE FOR SMALL & LARGE BUSHINGS

AT513H for Inch
AT513M for Metric
Hex Nut
Brass/Nickel

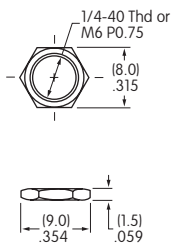

AT507H for Inch
Locking Ring
Steel with Zinc/Chromate

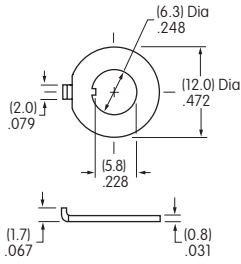

AT507M for Metric
Locking Ring
Steel with Zinc/Chromate

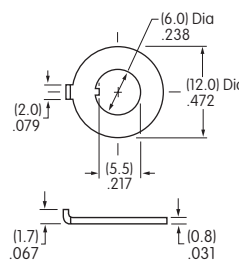

AT509
Lockwasher
Steel with Zinc/Chromate
(not supplied with splashproof models)

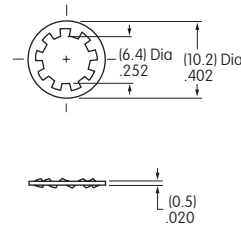

AT516
O-ring for Splashproof Models
Nitrile Butadiene Rubber

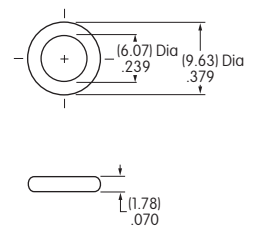

AT503M
Hex Face Nut
Brass/Chrome

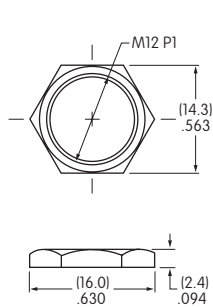

AT506M
Locking Ring
Steel with Zinc/Chromate

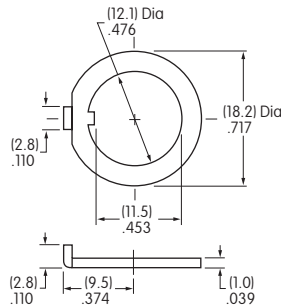

AT508
Lockwasher
Steel with Zinc/Chromate
(not supplied with splashproof models)

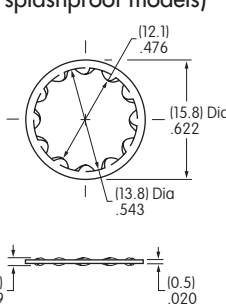

AT527M
Hex Nut
Steel with Nickel Plating

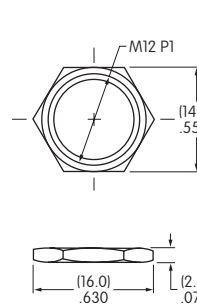

AT401P
O-ring for Splashproof Models
Nitrile butadiene rubber

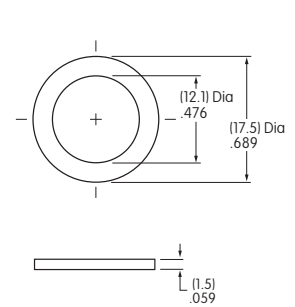

OPTIONAL SPLASHPROOF BOOTS

Various optional nuts and ON-OFF plates are available; dimensions are shown in the Accessories & Hardware section.

AT428 (M-metric H-Inch)
.445" (11.3mm)
Boot for S Toggle
Silicon Rubber

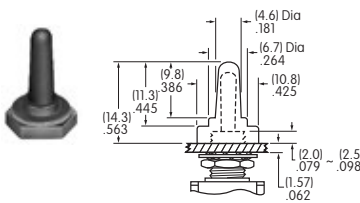

AT402
.760" (19.3mm)
Boot for B2 Toggle
Silicon Rubber

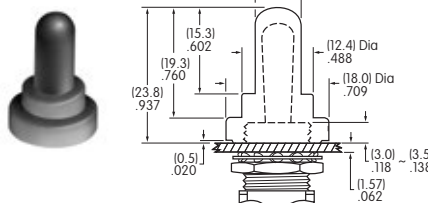

AT402S
.567" (14.4mm)
Boot for B Toggle
Silicon Rubber

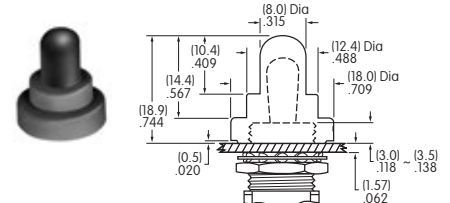

AT401A/H/S
.461" (11.7mm)
Boot, Nut and O-ring for B2 Toggle
More details in Accessories section

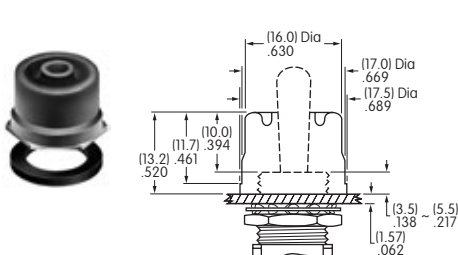

AT4181
.732" (18.6mm)
Boot, Nut and O-ring for B2 Toggle
More details in Accessories section

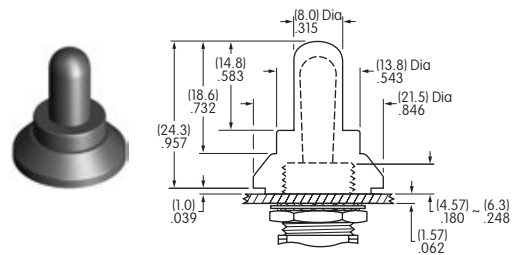

Toggles
A

Rockers

Pushbuttons

Illuminated PB

Programmable

Keylocks

Rotaries

Slides

Tactiles

Tilt

Touch

Indicators

Accessories

Supplement

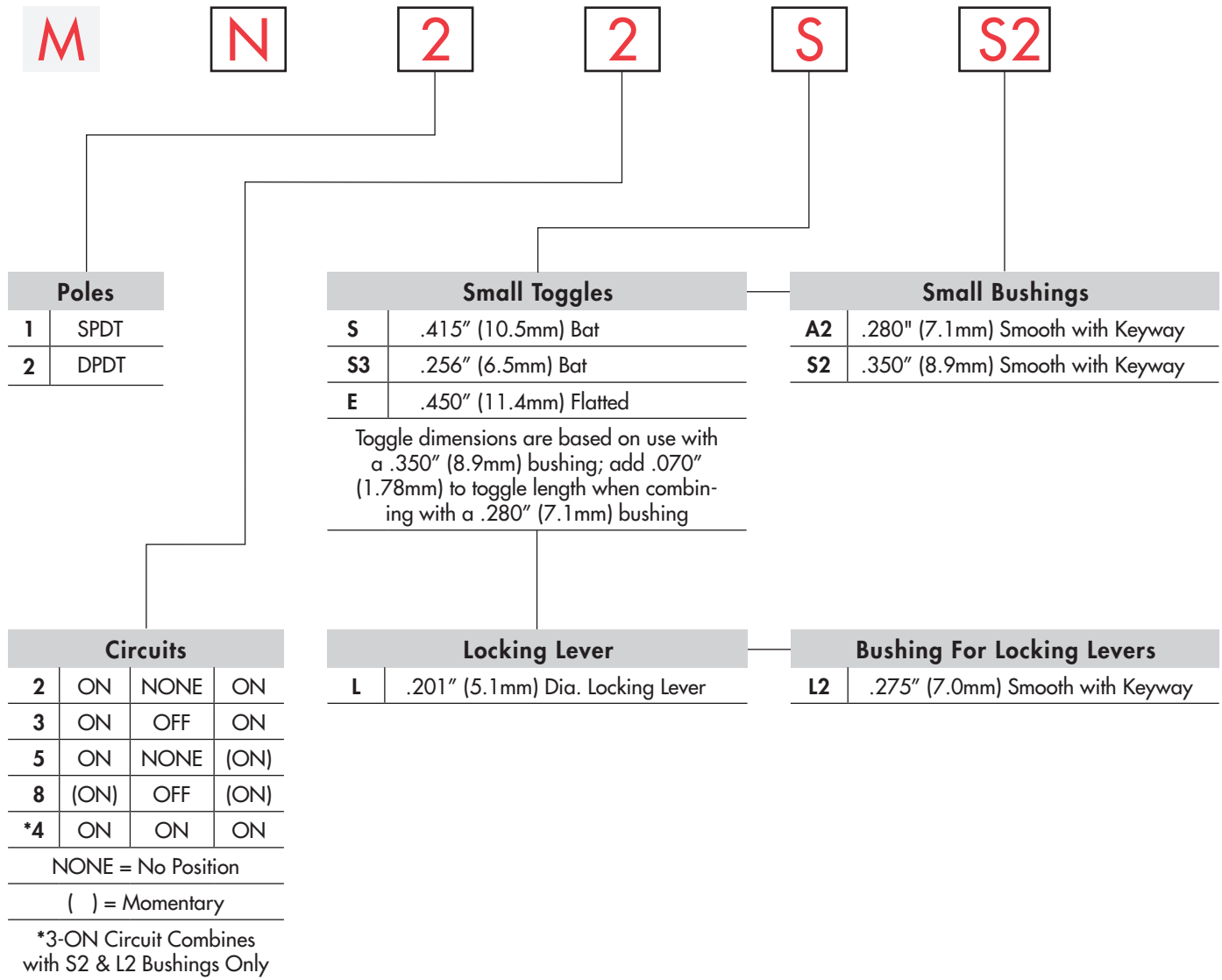

ORDERING EXAMPLE

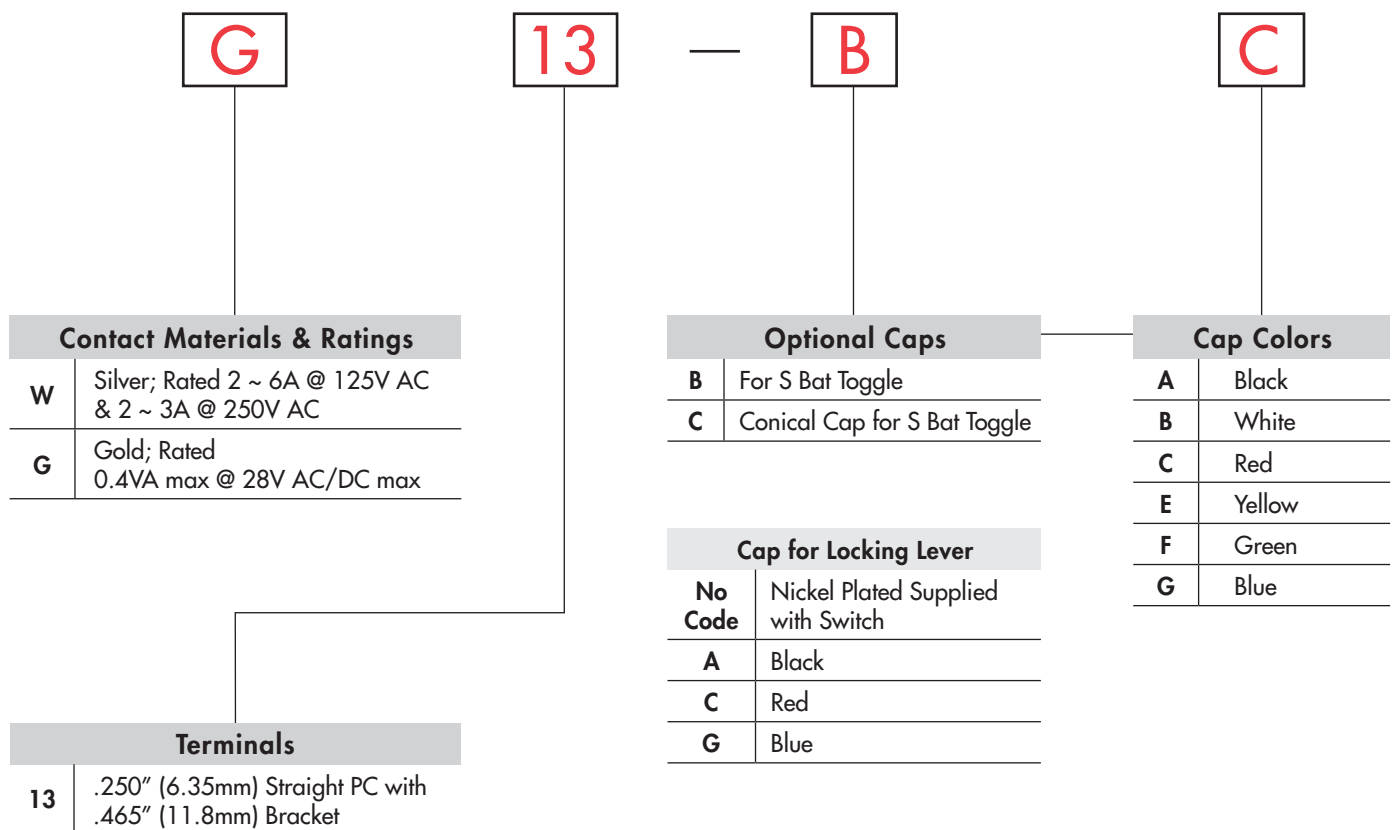

DESCRIPTION FOR TYPICAL ORDERING EXAMPLE

MN22SS2G13-BC

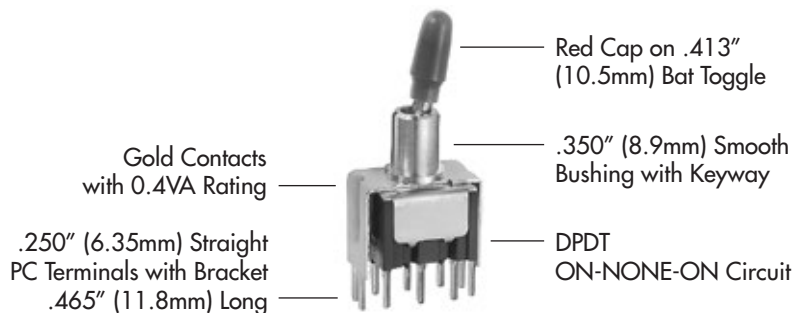

POLES & CIRCUITS

Pole	Model	Toggle Position			Connected Terminals			Throw & Schematics
		Down <small>Keyway</small>	Center	Up	Down <small>Keyway</small>	Center	Up	
		NONE = No Position () = Momentary						
								Note: Terminal numbers are not actually on the switch.
SP	MN12 MN13 MN15 MN18	ON ON ON (ON)	NONE OFF NONE OFF	ON ON (ON) (ON)	2-3	OPEN	2-1	SPDT
DP	MN22 MN23 MN25 MN28	ON ON ON (ON)	NONE OFF NONE OFF	ON ON (ON) (ON)	2-3 5-6	OPEN	2-1 5-4	DPDT

For 3 Throw (3-On)

Pole	Model	Connected Terminals & Schematics			External Connection
		Down	Center	Up	
SP	MN24	ON 2-3 5-6	ON 2-3 5-4	ON 2-1 5-4	<p>The SP3T model utilizes a double pole base.</p> <p>External connection must be made during field installation.</p>

SMALL TOGGLES

Important:

Toggle length changes based on bushing selected. All illustrations are shown with .350" (8.9mm) long bushing. When using a .280" (7.1mm) long bushing, toggle length increases .070" (1.78mm).

Standard Material & Finish:

Brass with Bright Chrome
Contact factory for optional finishes.

S .413" (10.5mm)
Bat

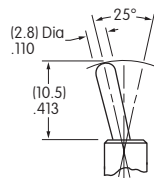

S3 .256" (6.5mm)
Bat

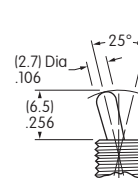

E .450" (11.4mm)
Flatted

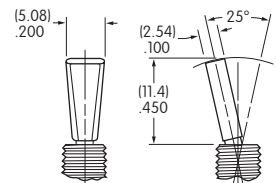

SMALL BUSHINGS

A2 .280" (7.1mm)
Smooth with Keyway

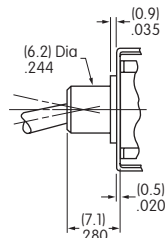
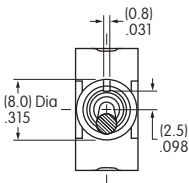

S2 .350" (8.9mm)
Smooth with Keyway

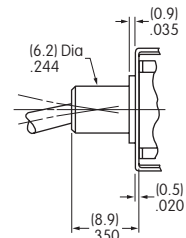
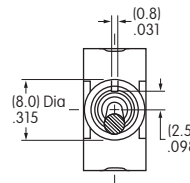

When using this bushing, toggle length is increased by .070" (1.78mm).

For A2 and S2 Bushings with Keyway

Panel Cutout

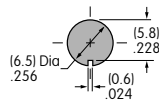

LL2 Smooth with Keyway

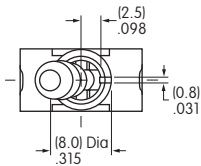

Locking Mechanism

on-none-on

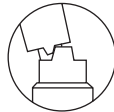

2 positions lock

on-none-(on)



1 position locks

on-off-on

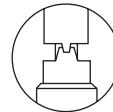

3 positions lock

(on)-off-(on)

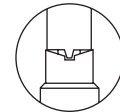

1 position locks

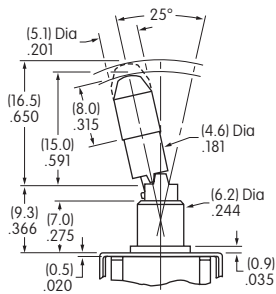

No Code

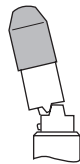

Cap for Locking Lever

Supplied with Cap AT427 Material & Finish:

Brass with Nickel Plating

Lever Material & Finish:

Brass with Chrome Plating

Color Codes for Optional Anodized Aluminum Caps



Black



Red



Blue

CONTACT MATERIALS & RATINGS

W

Silver Power Levels

MN12, MN22: 6A @ 125V AC, 3A @ 250V AC, 4A @ 30V DC

MN13, MN15, MN18, MN23, MN25: 6A @ 125V AC, 3A @ 250V AC, 3A @ 30V DC

MN28: 4A @ 125V AC, 3A @ 250V AC, 3A @ 30V DC

MN24: 2A @ 125V AC, 2A @ 250V AC, 2A @ 30V DC

G

Gold

Logic Level

0.4VA maximum @ 28V AC/DC maximum

Note: See Supplement section to find complete explanation of operating range.

Gold over Silver

Power Level or Logic Level

See above for each rating

Note: This dual rated toggle is available as a custom option and suitable when two or more identical switches are used in logic and in power circuits within the same application. See Supplement section to find complete explanation of dual rating and operating range.

TERMINALS

Straight PC Mount with Bracket

13

.250" (6.35mm) Terminal with .465" (11.8mm) Bracket

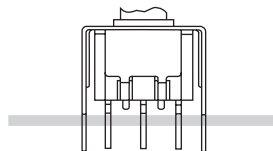

PCB footprints are on the following Typical Switch Dimension page.

OPTIONAL CAPS & CAP COLORS

B * AT415
for S Bat Toggle

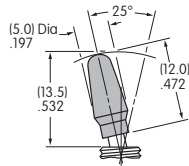

Material:
Polyethylene

C * AT444
Conical Cap for
S Bat Toggle

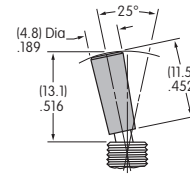

Material:
Polyethylene

* AT415 and AT444 for use with S toggles only, not S3 toggles.

Cap Colors Available:

A

Black

B

White

C

Red

E

Yellow

F

Green

G

Blue

TYPICAL SWITCH DIMENSIONS

Straight PC • Bracket

MN12S3A2G13

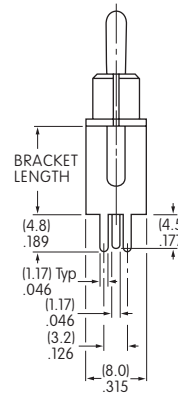
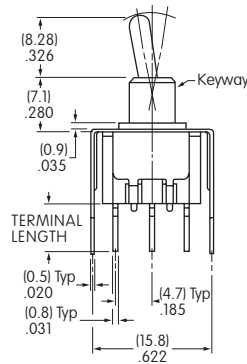

Single Pole

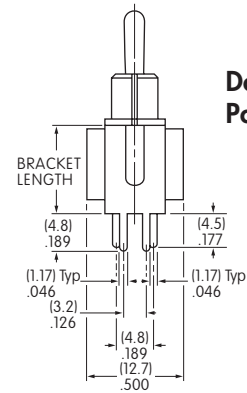

Double Pole

Terminal Code:	Terminal Length:	Bracket Length:
13	.250" (6.35mm)	.465" (11.8mm)

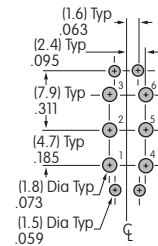
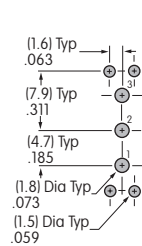

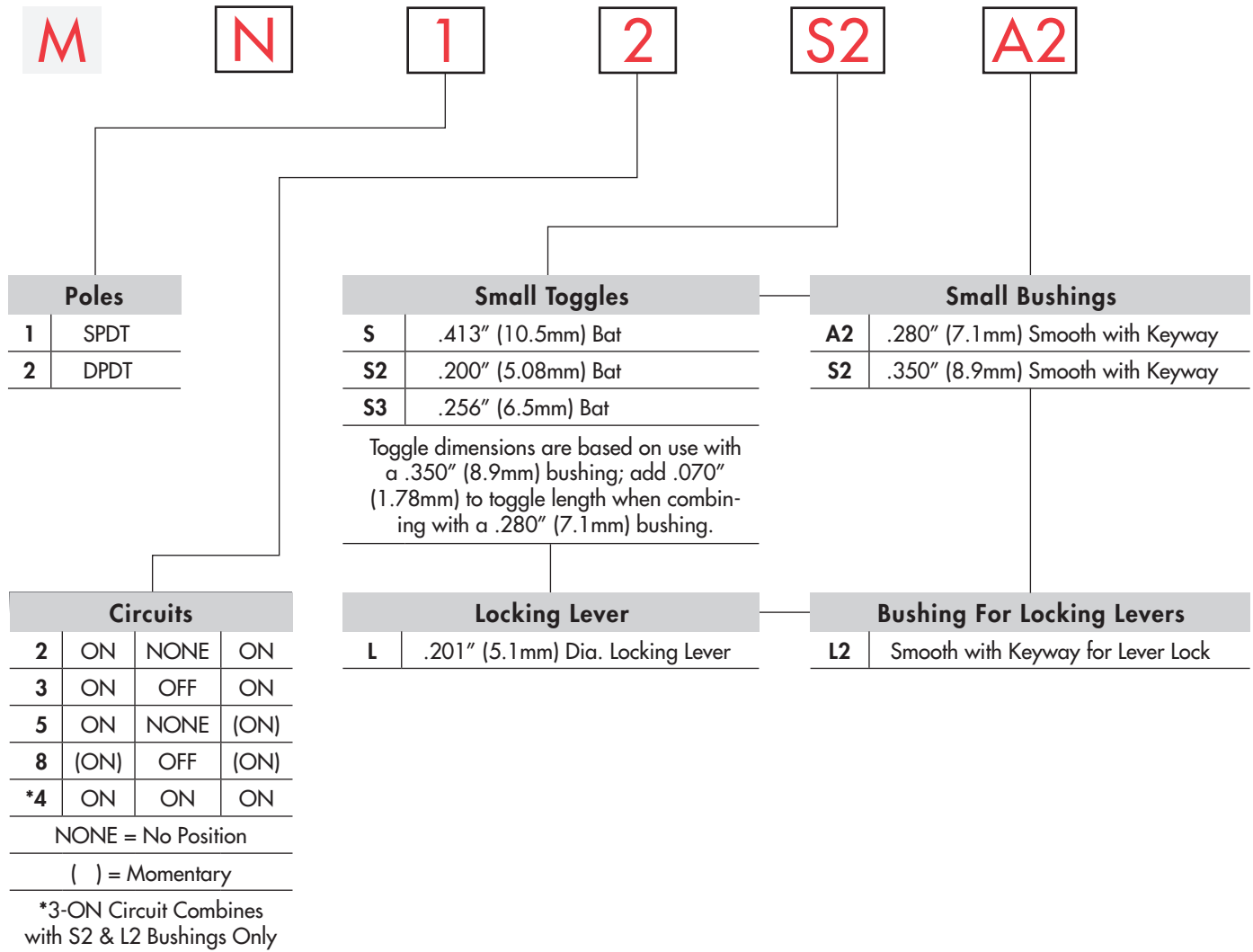

ORDERING EXAMPLE

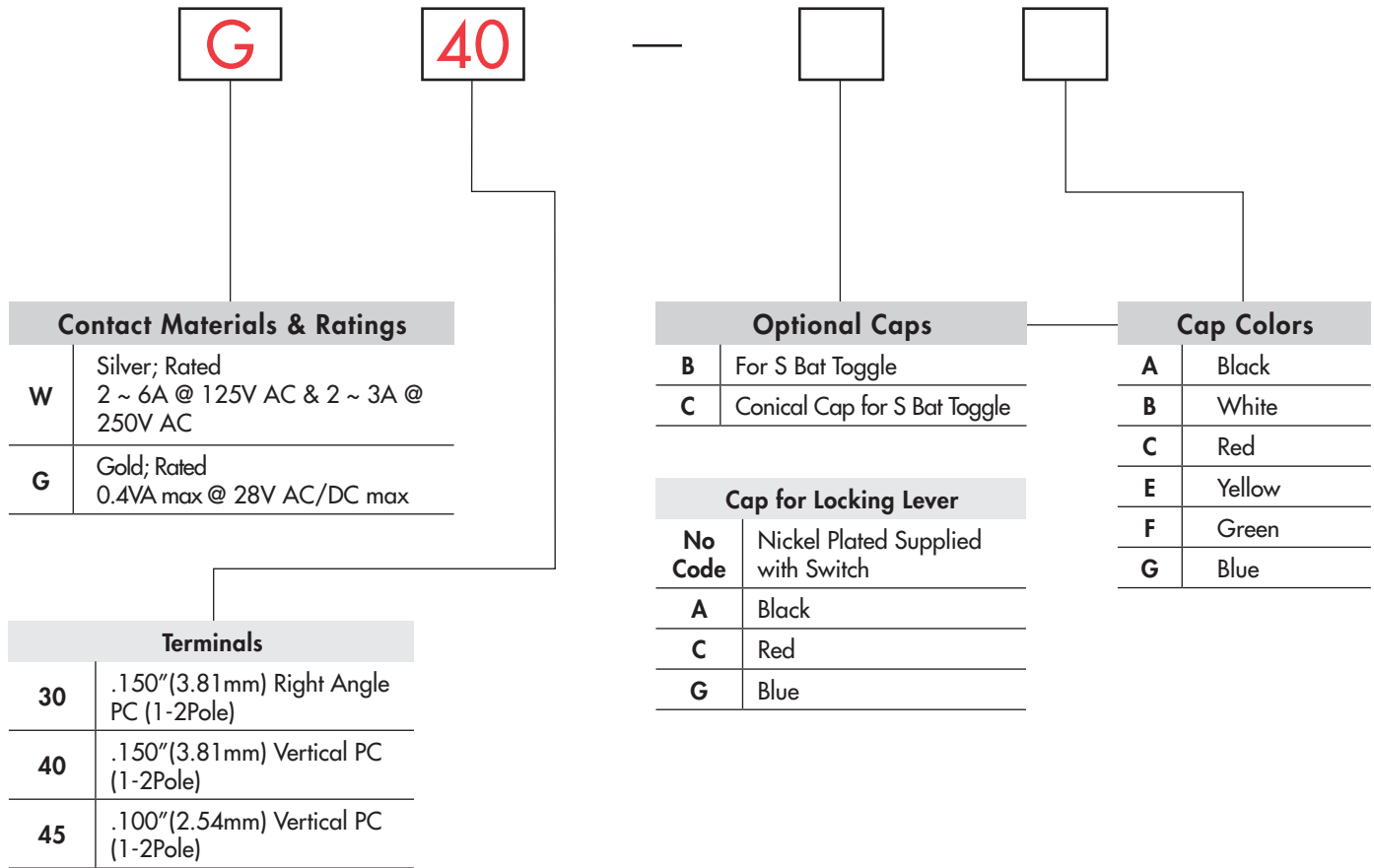

DESCRIPTION FOR TYPICAL ORDERING EXAMPLE

MN12S2A2G40

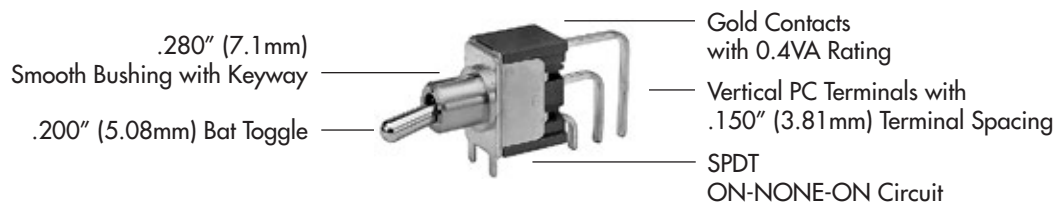

POLES & CIRCUITS

Pole	Model	Toggle Position			Connected Terminals			Throw & Schematics
		Down	Center	Up	Down	Center	Up	
NONE = No Position () = Momentary								
								Note: Terminal numbers are not actually on the switch. *Reverse circuits available for vertical mount SP & DP upon request.
SP	MN12 *MN13 MN15 *MN18	ON ON ON (ON)	NONE OFF NONE OFF	ON ON (ON) (ON)	2-3 	OPEN	2-1	SPDT
DP	MN22 *MN23 MN25 *MN28	ON ON ON (ON)	NONE OFF NONE OFF	ON ON (ON) (ON)	2-3 5-6 	OPEN	2-1 5-4	DPDT

For 3 Throw (3-On)

Pole	Model	Connected Terminals & Schematics			External Connection
		Down	Center	Up	
SP	MN24	ON 2-3 5-6	ON 2-3 5-4	ON 2-1 5-4	The SP3T model utilizes a double pole base. External connection must be made during field installation.

SMALL TOGGLES

Important:

Toggle length changes based on bushing selected. All illustrations are shown with .350" (8.9mm) long bushing. When using a .280" (7.1mm) long bushing, toggle length increases .070" (1.78mm).

S .413" (10.5mm) Bat

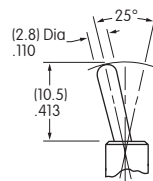

S2 .200" (5.08mm) Bat

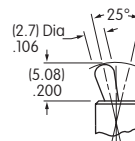

S3 .256" (6.5mm) Bat

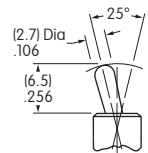

Standard Material & Finish: Brass with Bright Chrome
Contact factory for optional finishes.

SMALL BUSHINGS

A2 .280" (7.1mm) Smooth with Keyway

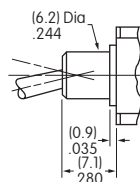
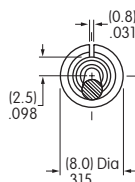

S2 .350" (8.9mm) Smooth with Keyway

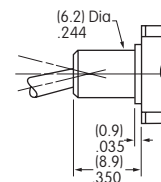
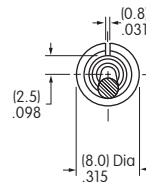

When using this bushing, toggle length is increased by .070" (1.78mm).

Panel Cutout

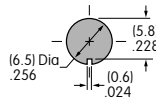

For A2 or S2 Bushing with Keyway

LOCKING LEVER & BUSHING

LL2 Smooth with Keyway

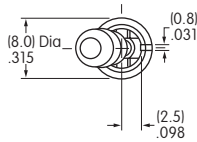

Locking Mechanism

on-none-on



2 positions lock

on-none-(on)



1 position locks

on-off-on

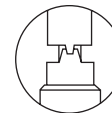

3 positions lock

(on)-off-(on)

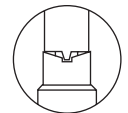

1 position locks

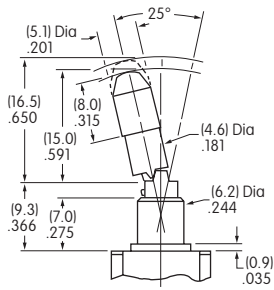

No Code

Cap for Locking Lever

Supplied with Cap AT427 Material & Finish:

Brass with Nickel Plating

Lever Material & Finish:

Brass with Chrome Plating

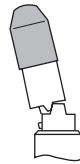

Color Codes for Optional Anodized Aluminum Caps

A

Black

C

Red

G

Blue

CONTACT MATERIALS & RATINGS

W

Silver Power Levels

MN12, MN22: 6A @ 125V AC, 3A @ 250V AC, 4A @ 30V DC
 MN13, MN15, MN18, MN23, MN25: 6A @ 125V AC, 3A @ 250V AC, 3A @ 30V DC
 MN28: 4A @ 125V AC, 3A @ 250V AC, 3A @ 30V DC
 MN24: 2A @ 125V AC, 2A @ 250V AC, 2A @ 30V DC

G

Gold

Logic Level

0.4VA maximum @ 28V AC/DC maximum

Note: See Supplement section to find complete explanation of operating range.

Gold over Silver

Power Level or Logic Level

See above for each ratings

Note: This dual rated toggle is available as a custom option and suitable when two or more identical switches are used in logic and in power circuits within the same application. See Supplement section to find complete explanation of dual rating and operating range.

TERMINALS

30 .150" (3.81mm)
Right Angle PC (1-2 Pole)

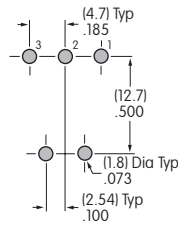
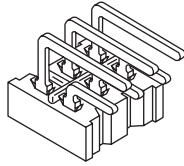

Single Pole

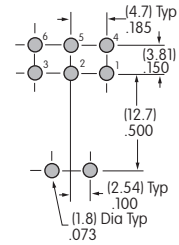

Double Pole

40 .150" (3.81mm)
Vertical PC (1-2 Pole)

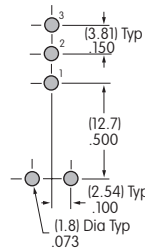
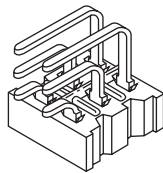

Single Pole

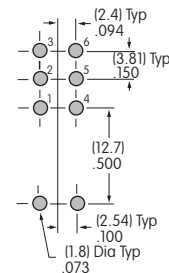

Double Pole

45 .100" (2.54mm)
Vertical PC (1-2 Pole)

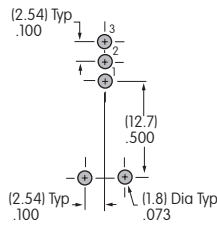
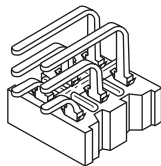

Single Pole

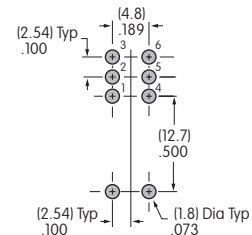

Double Pole

Terminal dimensions are shown on the Typical Switch Dimensions pages which follow.

OPTIONAL CAPS & CAP COLORS

B * AT415
for S Bat Toggle

Material:
Polyethylene

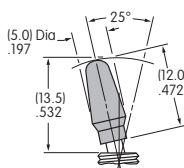

C * AT444
Conical Cap for S Bat Toggle

Material:
Polyethylene

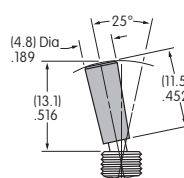

Colors Available

A

Black

E

Yellow

B

White

F

Green

C

Red

G

Blue

* AT415 and AT444 for use with S toggles only, not S2 or S3 toggles.

TYPICAL SWITCH DIMENSIONS

Single Pole

.150" (3.81mm) Right Angle PC

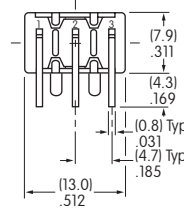
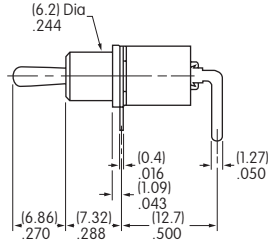
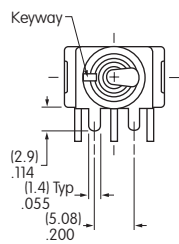

MN12S2A2W30

Double Pole

.150" (3.81mm) Right Angle PC

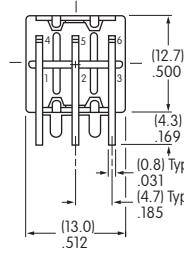
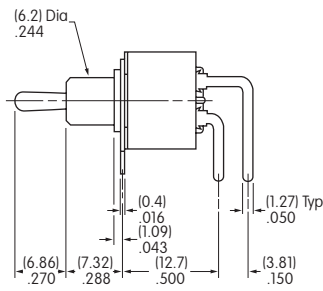
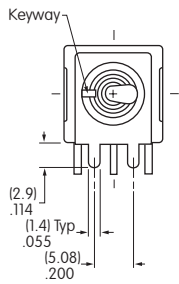

MN22S2A2G30

Single Pole

.150" (3.81mm) Vertical PC

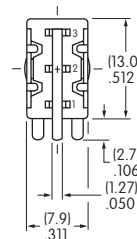
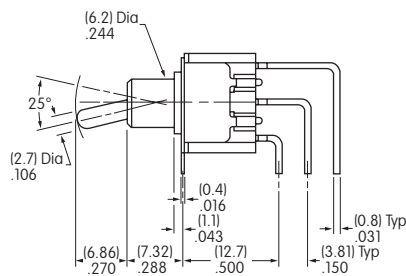
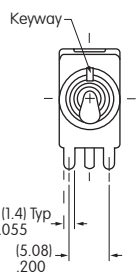

MN12S2A2G40

A	Toggles
	Rockers
	Pushbuttons
	Illuminated PB
	Programmable
	Keylocks
	Rotaries
	Slides
	Tactiles
	Tilt
	Touch
	Indicators
	Accessories
	Supplement

TYPICAL SWITCH DIMENSIONS

.150" (3.81mm) Vertical PC

Double Pole

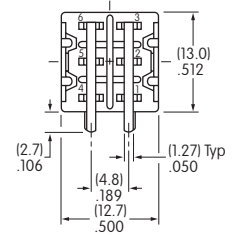
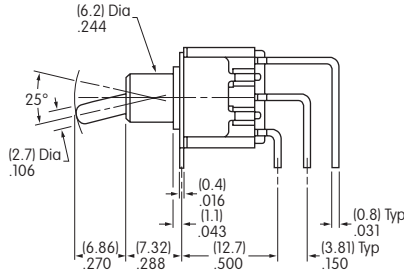
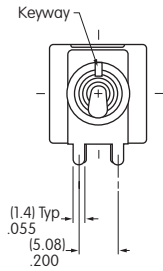

MN22S2A2G40

.100" (2.54mm) Vertical PC

Single Pole

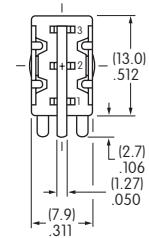
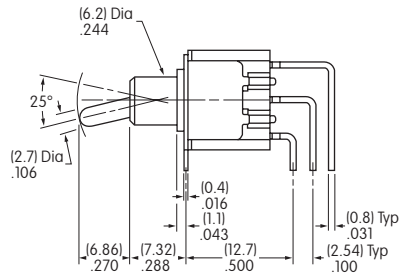
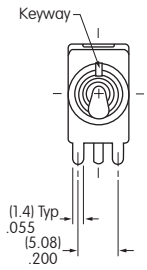

MN12S2A2G45

.100" (2.54mm) Vertical PC

Double Pole

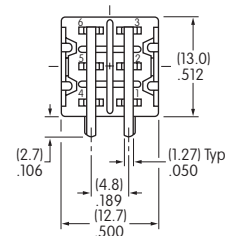
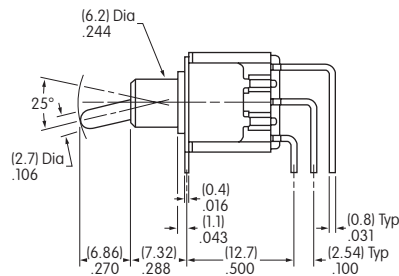
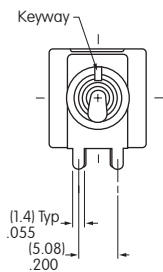

MN22S2A2G45

Rockers

Pushbuttons

Illuminated PB

Programmable

Keylocks

Rotaries

Slides

Tactiles

Tilt

Touch

Indicators

Accessories

Supplement

M-N11B ; M-N11B ; M-NIIB ;
M-N11B1 ; M-N11BI ; M-NIIB1 ; M-NIIB1 ;
M-N11G ; M-NIIG4 ; M-N11G4 ; M-N11P ; M-N11P1 ; M-NIIP1 ;
M-N11PI ; M-NIIP1 ; M-N11S1 ; M-N11SI ;
M-N12B ; M-N12B1 ; M-N12B4 ; M-N12BI ;
M-N12G ; M-NI2G ; M-N12G3 ; M-NI2G3 ;
M-N12G4 ; M-N12H ; M-N12H1 ; M-N12H4 ;
M-N12HI ; M-N12P ; M-N12P ; M-NI2P ;
M-N12P1 ; M-N12PI ; M-N12P4 ; M-N12S1 ;
M-N12SI ; M-N12V ; M-NI2V ;
M-N12V1 ; M-N12V4 ; M-N12VI ; M-NI2V1 ; M-NI2VI ;
M-N13B ; M-N13B1 ; M-N13B4 ; M-N13BI ;
M-N13G ; M-NI3G ; M-N13G3 ; M-NI3G3 ;
M-N13G4 ; M-N13H ; M-NI3H ;
M-N13H1 ; M-NI3H1 ; M-N13H4 ; M-N13HI ; M-NI3HI ;
M-N13P ; M-NI3P ; M-N13P1 ; M-N13PI ;
M-N13P4 ; M-N13S ; M-N13S1 ; M-N13SI ;
M-N13V ; M-NI3V ; M-N13V1 ; M-NI3V1 ;
M-N13V4 ; M-N13VI ; M-NI3VI ; M-N13W ; M-N13W4 ; M-N15B ; M-N15B ;
M-N15B1 ; M-N15BI ; M-N15B4 ; M-N15G ;
M-N15G4 ; M-N15H ; M-N15H1 ; M-N15HI ;
M-N15H4 ; M-N15P ; M-N15P1 ; M-N15PI ;
M-N15P4 ; M-N15S ; M-N15S1 ; M-N15SI ;
M-N15V ; M-NI5VI ; M-NI5V ;
M-N15V1 ; M-NI5V1 ; M-N15V4 ; M-N15W4 ; M-NI5W4 ;
M-N18B ; M-N18B ; M-N18B1 ; M-N18BI ;
M-N18B4 ; M-N18G ; M-N18G3 ; M-NI8G3 ;
M-N18G4 ; M-N18H ; M-NI8H ; M-NI8H1 ;
M-N18H1 ; M-N18HI ; M-NI8HI ; M-N18H4 ; M-N18P ; M-N18P1 ; M-N18PI ;
M-N18P4 ; M-N18S ; M-N18S1 ; M-N18SI ;
M-N18V ; M-N18V1 M-NI8V ; ; M-N18VI
M-N18V4 ; M-N19B ; M-NI9B ; M-N19BI ;
M-N19B1 ; M-NI9B1 ; M-N19B4 ; M-N19G ; M-NI9G
M-N19G4 ; M-N19H ; M-NI9H ; M-N19HI ;
M-N19H1 ; M-NI9HI ; M-NI9H1 ; M-N19H4 ; M-N19P ; M-NI9P ;
M-N19P1 ; M-NI9P1 ; M-N19P4 ; M-N19PI ; M-NI9PI ;
M-N19S ; M-NI9S ; M-N19S1 ; M-N19SI ; M-N19V ; M-NI9V ; M-N19VI ;
M-N19V1 ; M-NI9V1 ; M-NI9VI ; M-N19V4 ; M-N21B ; M-N21B ;
M-N21B1 ; M-N21BI ; M-N21G ; M-N21G ;
M-N21G4 ; M-N21P ; M-N21P ; M-N21P1 ; M-N21PI ; M-N21S ; M-N21S ;
M-N21S1 ; M-N21SI ; M-N22B ; M-N22B1 ; M-N22B4 ; M-N22BI ;
M-N22G ; M-N22G4 ; M-N22H ; M-N22H1 ; M-N22HI ; M-N22H4 ;

M-N22P ; M-N22P1 ; M-N22P4 ; M-N22PI ; M-N22S ; M-N22S1 ;
M-N22SI ; M-N22V ; M-N22V1 ; M-N22VI ; M-N22V4 ; M-N23B ;
M-N23B1 ; M-N23B4 ; M-N23BI ; M-N23G ; M-N23G4 ; M-N23H ;
M-N23H1 ; M-N23HI ; M-N23H4 ; M-N23P ; M-N23P1 ; M-N23P4 ;
M-N23PI ; M-N23S ; M-N23S1 ; M-N23SI ; M-N23V ; M-N23V1 ;
M-N23V4 ; M-N23VI ; M-N24B ; M-N24B1 ; M-N24B4 ; M-N24BI ;
M-N24G4 ; M-N24H ; M-N24HI ; M-N24H1 ; M-N24H4 ; M-N24P ;
M-N24P1 ; M-N24P4 ; M-N24PI ; M-N24S ; M-N24S1 ;
M-N24SI ; M-N24V ; M-N24VI ; M-N24V1 ; M-N24V4 ; M-N25B ; M-N25B1 ;
M-N25B4 ; M-N25BI ; M-N25G ; M-N25G4 ; M-N25H ; M-N25HI ;
M-N25H1 ; M-N25H4 ; M-N25P ; M-N25P1 ; M-N25P4 ;
M-N25PI ; M-N25S ; M-N25S1 ; M-N25SI ; M-N25V ; M-N25VI ; M-N25V1 ;
M-N25V4 ; M-N25W ; M-N25W4 ; M-N26B ; M-N26B1 ;
M-N26B4 ; M-N26BI ; M-N26G ; M-N26G4 ;
M-N26H ; M-N26H4 ; M-N26P ; M-N26P1 ;
M-N26P4 ; M-N26PI ; M-N26S ; M-N26S1 ;
M-N26SI ; M-N26V ; M-N26V4 ; M-N27B ; M-N27B1 ; M-N27B4 ; M-N27BI ;
M-N27G ; M-N27G4 ; M-N27H ; M-N27H4 ;
M-N27P ; M-N27P1 ; M-N27P4 ; M-N27PI ;
M-N27S ; M-N27S1 ; M-N27SI ; M-N27V ; M-N27V4 ;
M-N28B ; M-N28B1 ; M-N28B4 ; M-N28BI ;
M-N28G ; M-N28G4 ; M-N28H ; M-N28H1 ;
M-N28H4 ; M-N28HI ; M-N28P ; M-N28P1 ;
M-N28P4 ; M-N28PI ; M-N28S ; M-N28S1 ;
M-N28SI ; M-N28V ; M-N28V1 ; M-N28V4 ; M-N28VI ; M-N29B ; M-N29B1 ;
M-N29B4 ; M-N29BI ; M-N29G ; M-N29G4 ;
M-N29H ; M-N29H1 ; M-N29H4 ; M-N29HI ;
M-N29P ; M-N29P1 ; M-N29P4 ; M-N29PI ;
M-N29S ; M-N29S1 ; M-N29SI ; M-N29V ; M-N29VI ;
M-N29V1 ; M-N29V4 ; M-N2IB1 ; M-N2IBI ;
M-N2IG4 ; M-N2IP1 ; M-N2IPI ; M-N2IS1 ;
M-N2ISI ; M-NI2B4 ; M-NI2BI ; M-NI2B1 ;
M-NI2G4 ; M-NI2H ; M-NI2H4 ; M-NI2HI ; M-NI2H1 ;
M-NI2P4 ; M-NI2PI ; M-NI2P1 ; M-NI2S1 ; M-NI2SI ; M-NI2V4 ; M-NI3B ;
M-NI3B1 ; M-NI3BI ; M-NI3B4 ; M-NI3G4 ;
M-NI3H4 ; M-NI3P ; M-NI3P1 ; M-NI3P4 ;
M-NI3PI ; M-NI3S ; M-NI3S1 ; M-NI3SI ;
M-NI3V ; M-NI3V4 ; M-NI5B ; M-NI5B ;
M-NI5B1 ; M-NI5B4 ; M-NI5BI ; M-NI5G ;
M-NI5G4 ; M-NI5H ; M-NI5H1 ; M-NI5HI ;
M-NI5H4 ; M-NI5P ; M-NI5P ; M-NI5P1 ;
M-NI5P4 ; M-NI5PI ; M-NI5S ; M-NI5S1 ;
M-NI5SI ; M-NI5V4 ; M-NI8B ; M-NI8B1 ;
M-NI8B4 ; M-NI8BI ; M-NI8G4 ; M-NI8H4 ;

M-NI8P ; M-NI8P1 ; M-NI8P4 ; M-NI8PI ;
M-NI8S ; M-NI8S1 ; M-NI8V1 ; M-NI8VI ;
M-NI8V4 ; M-NI9B4 ; M-NI9BI ; M-NI9G4 ;
M-NI9H4 ; M-NI9P4 ; M-NI9S1 ; M-NI9SI ;
M-NI9V4 ; M-NIISI ; M-NIIS1 ; M-N32G ; M-N32G4 ; M-N32H ; M-N32H1 ;
M-N32HI ; M-N32P ; M-N32P1 ; M-N32P4 ;
M-N32PI ; M-N32S ; M-N32S1 ; M-N32SI ;
M-N32V ; M-N32V4 ; M-N33G ; M-N33G4 ;
M-N33P ; M-N33P1 ; M-N33P4 ; M-N33PI ;
M-N33S ; M-N33S1 ; M-N33SI ; M-N33W ; M-N33W4 ;
M-N35G ; M-N35G4 ; M-N35P ; M-N35P1 ;
M-N35P4 ; M-N35PI ; M-N35S ; M-N35S1 ; M-N35SI ;
M-N38G ; M-N38G4 ; M-N38P ; M-N38P1 ;
M-N38P4 ; M-N38PI ; M-N38S ; M-N38S1 ; M-N38SI ;
M-N39G ; M-N39G4 ; M-N39P ; M-N39P1 ;
M-N39P4 ; M-N39PI ; M-N39S ; M-N39S1 ; M-N39SI ;
M-N42G ; M-N42G4 ; M-N42P ; M-N42P1 ;
M-N42P4 ; M-N42PI ; M-N42S ; M-N42S1 ;
M-N42SI ; M-N43G ; M-N43G4 ; M-N43P ; M-N43P1 ; M-N43P4 ;
M-N43PI ; M-N43S ; M-N43S1 ; M-N43SI ; M-N44G ;
M-N44G4 ; M-N44P ; M-N44P1 ; M-N44P4 ;
M-N44PI ; M-N44S ; M-N44SI ;
M-N44S1 ; M-N45G ; M-N45G4 ; M-N45P ; M-N45P1 ; M-N45P4 ;
M-N45PI ; M-N45S ; M-N45S1 ; M-N45SI ; M-N46S ; M-N46S1 ;
M-N46SI ; M-N48G ; M-N48G4 ; M-N48P ; M-N48P1 ;
M-N48P4 ; M-N48PI ; M-N48S ; M-N48S1 ; M-N48SI ;
M-N49G ; M-N49G4 ; M-N49P ; M-N49P1 ;
M-N49P4 ; M-N49PI ; M-N49S ; M-N49S1 ; M-N49SI ;
M-NL12B ; M-NLI2B ; M-NL12B1 ; M-NLI2B1 ; M-NL12BI ;
M-NLI2BI ; M-NL12F ; M-NLI2F ; M-NL12F1 ; M-NLI2F1 ;
M-NL12FI ; M-NLI2FI ; M-NL12P ; M-NLI2P ; M-NL12P1 ;
M-NLI2P1 ; M-NL12PI ; M-NLI2PI ; M-NL12S ; M-NLI2S ;
M-NL12S1 ; M-NLI2S1 ; M-NL12SI ; M-NLI2SI ;
M-NL13B ; M-NLI3B ; M-NL13B1 ; M-NLI3B1 ;
M-NL13BI ; M-NLI3BI ; M-NL13F ; M-NLI3F ;
M-NL13F1 ; M-NLI3F1 ; M-NL13FI ; M-NLI3FI ;
M-NL13P ; M-NLI3P ; M-NL13P1 ; M-NLI3P1 ;
M-NL13PI ; M-NLI3PI ; M-NL13S ; M-NLI3S ;
M-NL13S1 ; M-NLI3S1 ; M-NL13SI ; M-NLI3SI ;