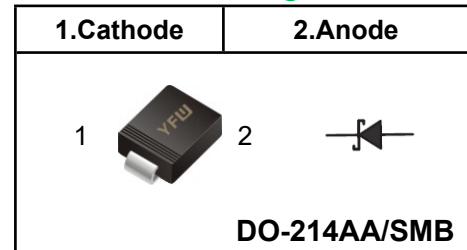


**Surface Mount Schottky Barrier Rectifier**
**Reverse Voltage - 45V**
**Forward Current - 5 A**
**FEATURES**

- ◆Metal silicon junction, majority carrier conduction
- ◆For surface mounted applications
- ◆Low power loss, high efficiency
- ◆High forward surge current capability
- ◆For use in low voltage, high frequency inverters, free wheeling, and polarity protection applications
- ◆Lead free in comply with EU RoHS 2011/65/EU directives

**MECHANICAL DATA**

- ◆Case: DO-214AA/SMB
- ◆Terminals: Solderable per MIL-STD-750, Method 2026
- ◆Approx. Weight: 0.095g / 0.003oz

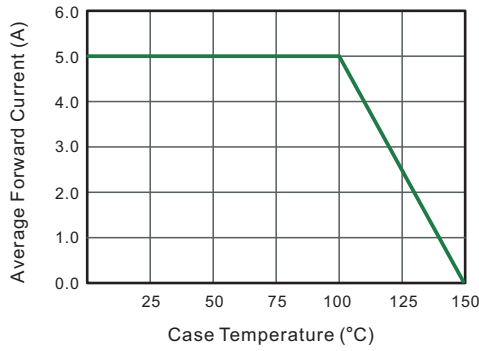
**Pinning**

**Marking Code**
**SSL545B**
**SSL545**
**Absolute Maximum Ratings and Electrical characteristics**
**Ratings at 25 ° ambient temperature unless otherwise specified. Single phase, half wave, 60Hz resistive or inductive load, for capacitive load, derate by 20 %**

Parameter	Symbols	SSL545B	Units
Maximum Repetitive Peak Reverse Voltage	$V_{RRM}$	45	V
Maximum RMS voltage	$V_{RMS}$	32	V
Maximum DC Blocking Voltage	$V_{DC}$	45	V
Maximum Average Forward Rectified Current	$I_{F(AV)}$	5.0	A
Peak Forward Surge Current, 8.3ms Single Half Sine-wave Superimposed On Rated Load (JEDEC method)	$I_{FSM}$	150	A
Maximum Instantaneous Forward Voltage at 5 A	$V_F$	0.45	V
Maximum Instantaneous Reverse Current at Rated DC Reverse Voltage	$I_R$	$T_A = 25^{\circ}C$ 1.0	mA
		$T_A = 100^{\circ}C$ 50	
Typical Junction Capacitance <sup>(1)</sup>	$C_j$	800	pF
Typical Thermal Resistance <sup>(2)</sup>	$R_{\theta JA}$	37	°C/W
Operating Junction Temperature Range	$T_j$	-55 ~ +150	°C
Storage Temperature Range	$T_{stg}$	-55 ~ +150	°C

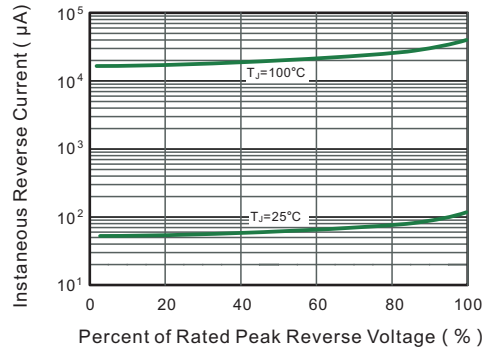
(1) Measured at 1 MHz and applied reverse voltage of 4 V D.C

(2) P.C.B. mounted with 2.0" X 2.0" (5 X 5 cm) copper pad areas.

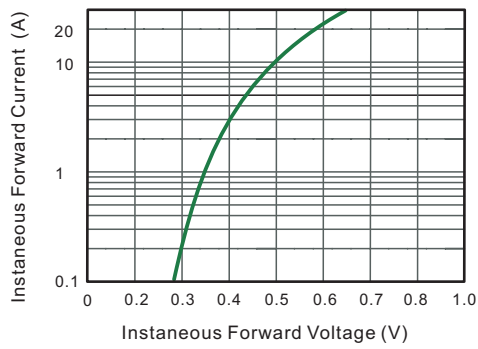
**Fig.1 Forward Current Derating Curve**



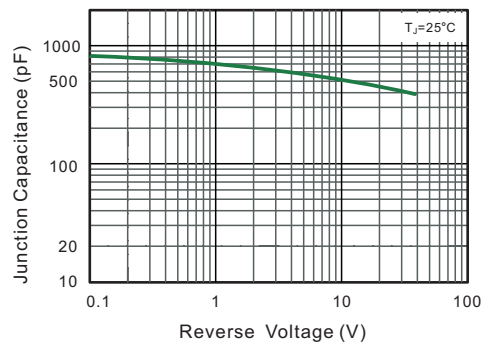
**Fig.2 Typical Reverse Characteristics**



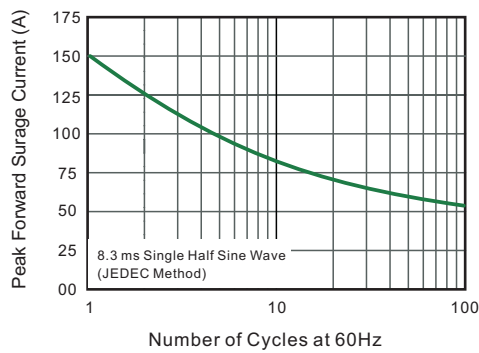
**Fig.3 Typical Forward Characteristic**



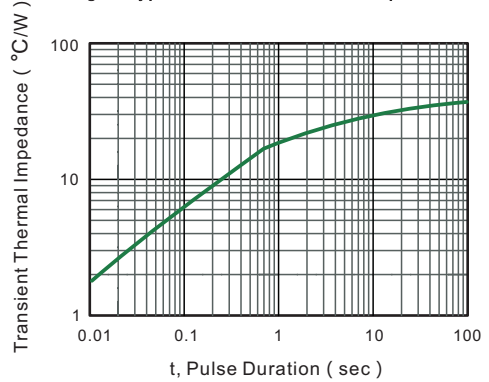
**Fig.4 Typical Junction Capacitance**



**Fig.5 Maximum Non-Repetitive Peak Forward Surge Current**

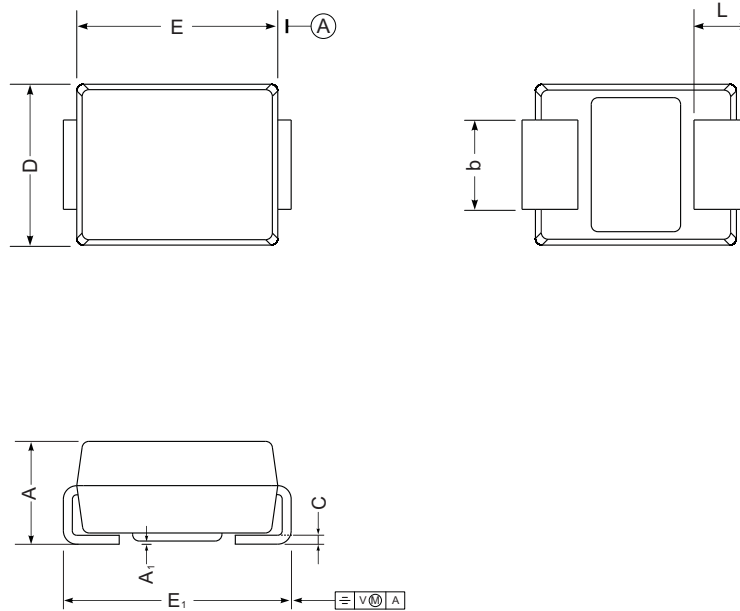


**Fig.6- Typical Transient Thermal Impedance**



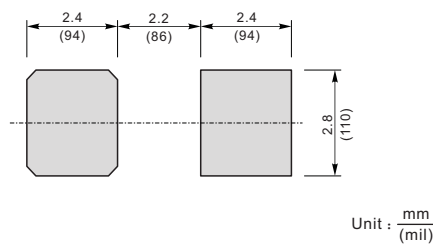
**Package Outline DO-214AA SMB**

Plastic surface mounted package; 2 leads



UNIT		A	E	D	E <sub>1</sub>	A <sub>1</sub>	L	C	b
mm	max	2.44	4.70	3.94	5.59	0.20	1.5	0.305	2.2
	min	2.13	4.06	3.3	5.08	0.05	0.8	0.152	1.9
mil	max	96	185	155	220	7.9	59	12	87
	min	84	160	130	200	2.0	32	6	75

**The recommended mounting pad size**



**Summary of Packing Options**

Package	Packing Description	Packing Quantity	Industry Standard
DO-214AA SMB	Tape/Reel, 13" reel	3000	EIA-481-1