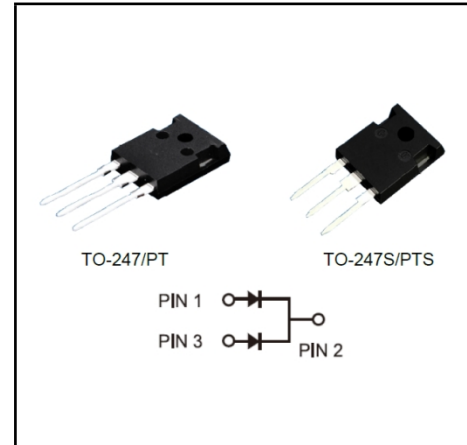

SCHOTTKY BARRIER RECTIFIER
Reverse Voltage - 100 V
Forward Current - 30 A
FEATURES

- ◆Low forward voltage
- ◆High current capability
- ◆High forward surge capability
- ◆Low power losses · High efficiency
- ◆Guarding for over voltage protection
- ◆Lead free in comply with EU RoHS 2011/65/EU directives

MECHANICAL DATA

- ◆Case: TO-247/PT TO-247/PTS
- ◆Solder bath temperature 275°C maximum, 10s per JESD22-106

Primary Characteristic

I_o	2*15A
V_{RRM}	100V
I_{FSM}	220A
V_F	0.63V
T_J Max	150°C

Maximum Ratings (Per Leg) at Ta=25°C unless otherwise specified

Parameter	Symbols	Value	Units
Maximum Repetitive Peak Reverse Voltage	V_{RRM}	100	V
Maximum RMS voltage	V_{RMS}	70	V
Maximum DC Blocking Voltage	V_{DC}	100	V
Maximum Average Forward Rectified Current	Per Leg	15	A
	Total	30	
Peak Forward Surge Current, 8.3ms Single Half Sine-wave	I_{FSM}	220	A
Operating Temperature Range	T_J	-50 ~ +150	°C
Storage Temperature Range	T_{STG}	-50 ~ +150	°C
Typical Thermal Resistance (Note1)	R_{θJA} R_{θJC}	2	°C/W

Note1: Thermal resistance from Junction to case per leg mounted on heatsink.
Electrical Characteristics (Per Leg) unless otherwise specified

Characteristics	Symbols	Value		Units	
Forward Voltage Drop(Note2)	V_F	Typ	Max	V	
at I _F =5A		TA=25°C	0.50		-
		TA=125°C	0.44		-
at I _F =10A		TA=25°C	0.58		0.66
		TA=125°C	0.56		-
at I _F =15A		TA=25°C	0.67		0.73
	TA=125°C	0.63	-		
Maximum Reverse Current at V _R =100V	I_R	TA=25°C	10	uA	
		TA=125°C	8	mA	

Note2: Pulse test: 300 μs pulse width, 1 % duty cycle

RATINGS AND CHARACTERISTIC CURVES

FIG.1 MAXIMUM FORWARD CURRENT DERATING CURVE

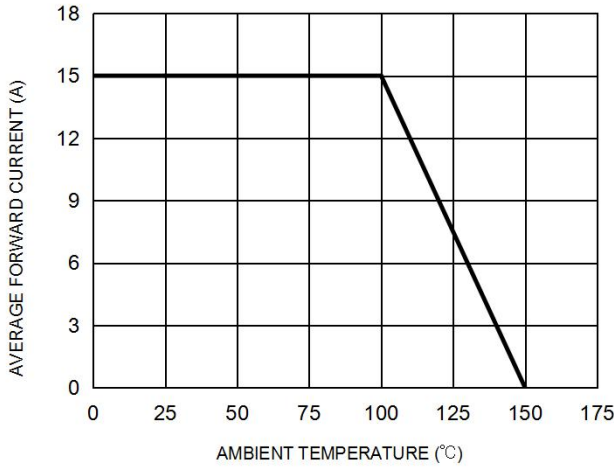

FIG. 2 MAXIMUM NON-REPETITIVE FORWARD SURGE CURRENT PER LEG

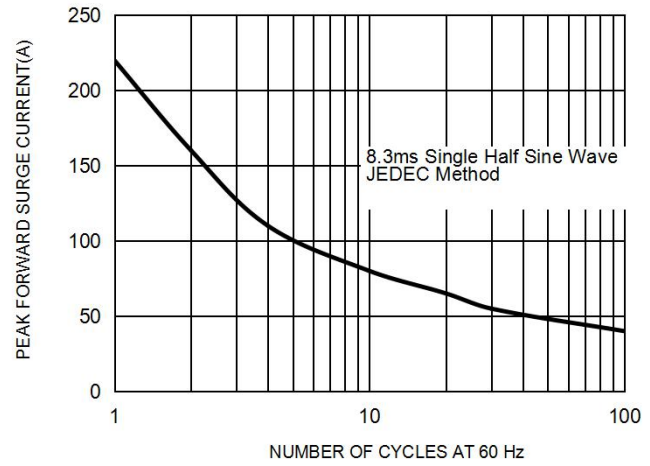

FIG. 3 TYPICAL FORWARD CHARACTERISTICS PER LEG

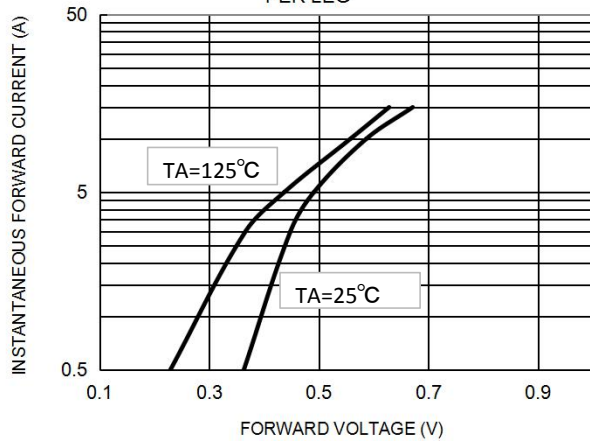
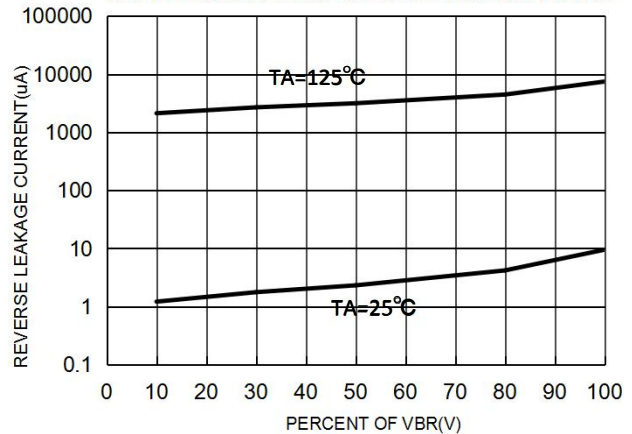
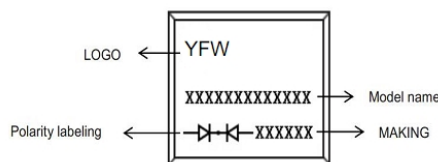

FIG. 4 TYPICAL REVERSE CHARACTERISTICS PER LEG



Marking on the body



MAKING:

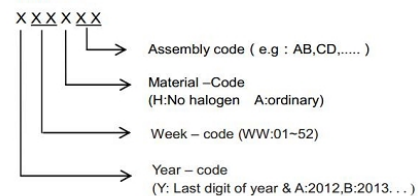

Ordering information

Part Number	Package	Unit Weight	Base Quantity	Delivery mode
SRT30L100PT	TO-247	0.209oz(5.93g)	30 pcs / tube	600pcs/box 2400pcs/carton
SRT30L100PTS	TO-247S	0.158oz(4.48g)	30 pcs / tube	600pcs/box 2400pcs/carton

Note: For Halogen Free molding compound, add "H" suffix to part number above.

Package Outline Dimensions millimeters

TO-247

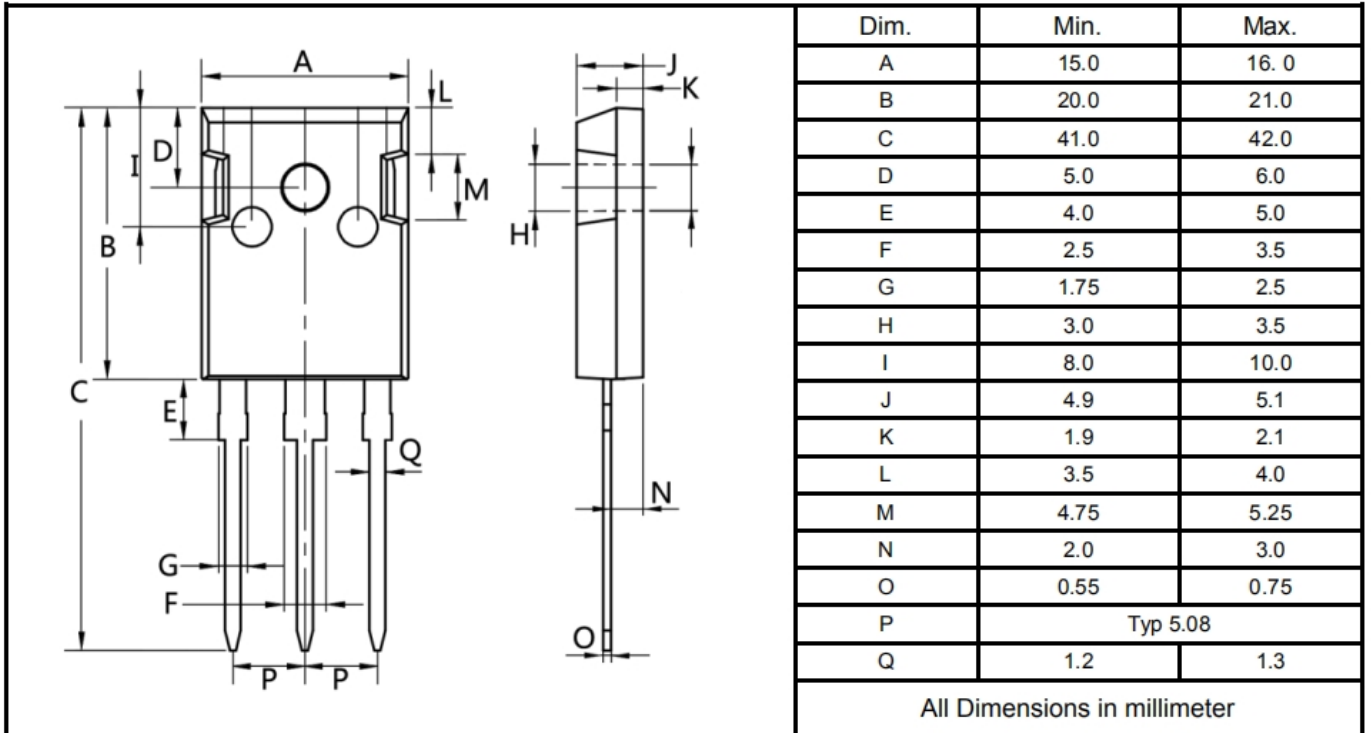

TO-247S

