

Trench MOS Barrier Schottky Rectifier Low VF Low IR

Reverse Voltage - 45 V

Forward Current - 10 A

FEATURES

- ◆ Advanced trench technology
- ◆ Low forward voltage drop
- ◆ Low power losses
- ◆ High efficiency operation
- ◆ Lead free in comply with EU RoHS 2011/65/EU directives

MECHANICAL DATA

- ◆ Case: TO-277
- ◆ Terminals: Solderable per MIL-STD-750, Method 2026

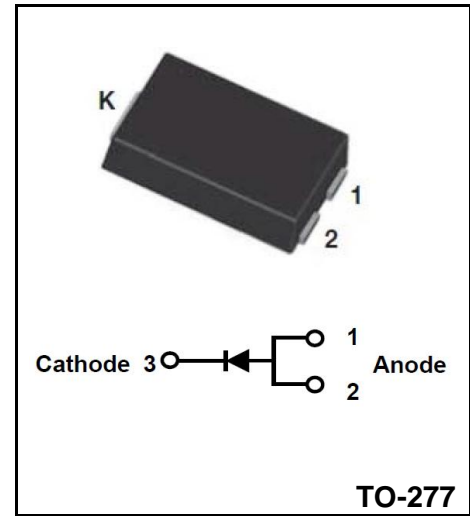

Maximum Ratings (Per Leg) at Ta=25°C unless otherwise specified

| Parameter | | Symbols | Value | Units |
|--|-----------|-----------------|------------|-------|
| Maximum Repetitive Peak Reverse Voltage | | V_{RRM} | 45 | V |
| Maximum RMS voltage | | V_{RMS} | 45 | V |
| Maximum DC Blocking Voltage | | V_{DC} | 45 | V |
| Maximum Average Forward Rectified Current | Per diode | $I_{F(AV)}$ | 10 | A |
| Peak Forward Surge Current, 8.3ms Single Half Sine-wave superimposed on rated load per diode | | I_{FSM} | 240 | A |
| Operating Temperature Range | | T_J | -55 ~ +150 | °C |
| Storage Temperature Range | | T_{STG} | -55 ~ +150 | °C |
| Typical Thermal Resistance Per diode(munted on FR-4 PCB) | TO-277 | $R_{\theta JC}$ | 72 | °C/W |

Note1: Thermal resistance from Junction to case per leg mounted on heatsink.

Electrical Characteristics (Per Leg) unless otherwise specified

| Characteristics | | Symbols | Value | | Units |
|--|----------|---------|-------|------|-------|
| Forward Voltage Drop(Note2) | | V_F | Typ | Max | V |
| at $I_F=2A$ Instantaneous forward voltage per diode | TA=25°C | | 0.34 | - | |
| | TA=125°C | | 0.22 | - | |
| at $I_F=10A$ Instantaneous forward voltage per diode | TA=25°C | | 0.43 | 0.47 | |
| | TA=125°C | 0.34 | - | | |
| Instantaneous reverse current per diode at rated reverse voltage | TA=25°C | I_R | 25 | 100 | uA |
| | TA=125°C | | - | 50 | mA |

**Note2: (1)Pulse test: 300 μs pulse width, 1 % duty cycle
(2) Pulse test: Pulse width ≤ 40 ms**

RATINGS AND CHARACTERISTIC CURVES

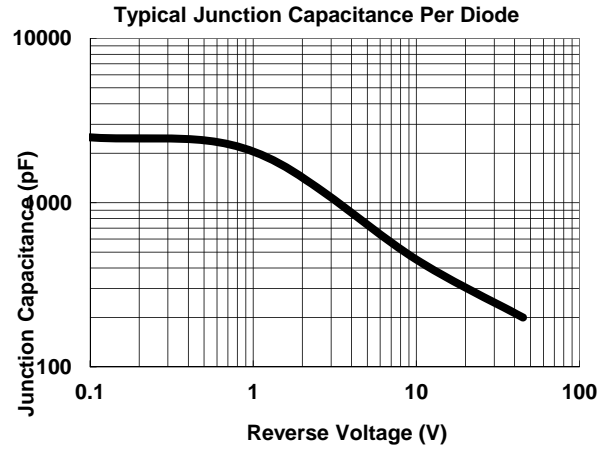
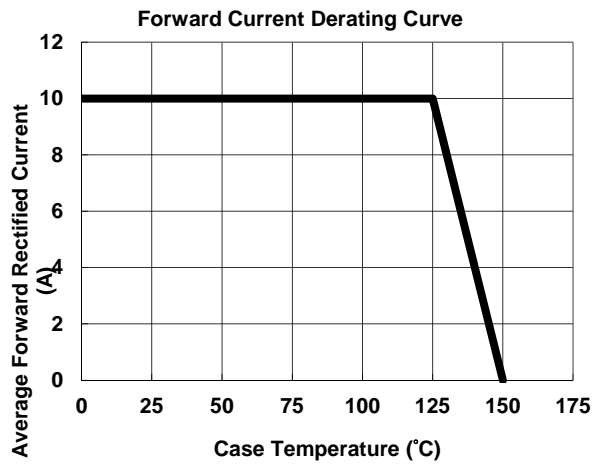
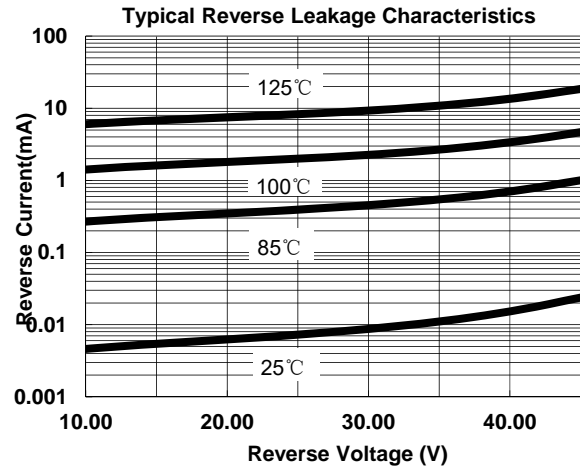
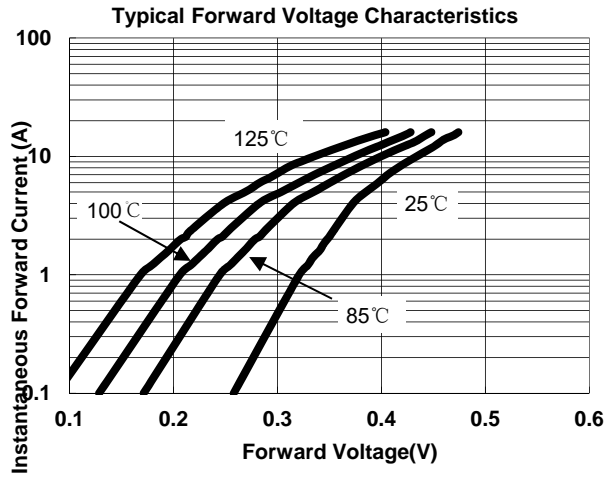

Package Outline TO-277

Plastic surface mounted package; 3 leads

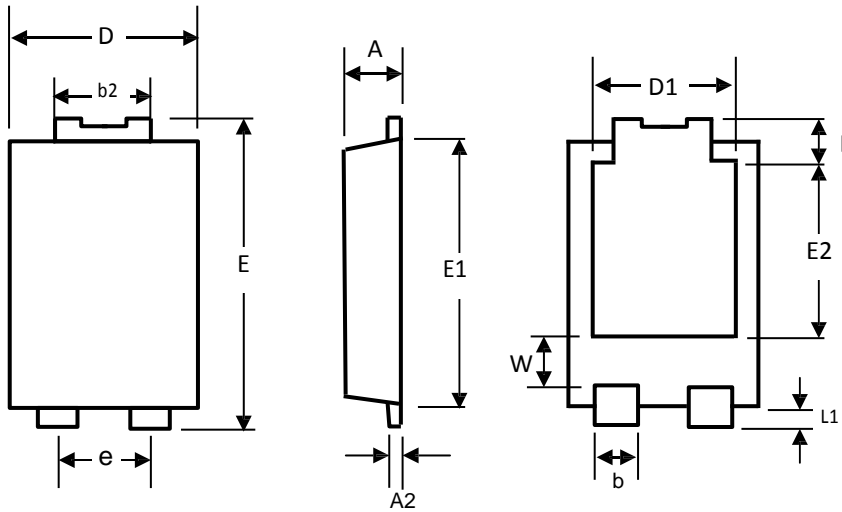

| Dim | Min | Max |
|-----|-------|-----|
| A | 1.1 | 1.2 |
| A2 | 0.3 | 0.4 |
| b1 | 0.8 | 1 |
| b2 | 1.7 | 1.9 |
| D | 3.9 | 4.1 |
| D1 | 3.054 | |
| E | 6.4 | 6.6 |
| e | 1.84 | |
| E1 | 5.3 | 5.5 |
| E2 | 3.549 | |
| L | 0.8 | 1 |
| L1 | 0.5 | 0.7 |
| W | 1.1 | 1.4 |

unit:mm

Mounting Pad Layout

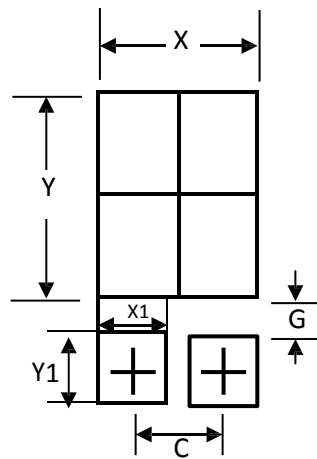

| Dim | Min |
|-----|-----|
| C | 1.8 |
| G | 0.9 |
| X | 3.4 |
| X1 | 1.4 |
| Y | 4.9 |
| Y1 | 1.4 |

unit:mm

Summary of Packing Options

| Package | Packing Description | Packing Quantity | Industry Standard |
|---------|---------------------|------------------|-------------------|
| TO-277 | Tape/Reel,13"reel | 5000 | EIA-481-1 |