

Surface Mount Ultrafast Recovery Rectifier

Reverse Voltage - 50 to 1000 V

Forward Current - 3 A

FEATURES

- ◆ For surface mounted applications
- ◆ Low profile package
- ◆ Glass Passivated Chip Junction
- ◆ High efficiency
- ◆ Lead free in comply with EU RoHS 2011/65/EU directives

MECHANICAL DATA

- ◆ Case: SMAF
- ◆ Terminals: Solderable per MIL-STD-750, Method 2026
- ◆ Approx. Weight: 27mg / 0.00095oz

Maximum Ratings and characteristics

Ratings at 25 °C ambient temperature unless otherwise specified.

Single phase half-wave 60 Hz, resistive or inductive load, for capacitive load current derate by 20 %.

Pinning

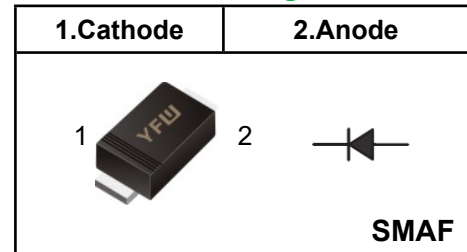

Marking Code

| | |
|--------------|-------------|
| US3AF | US3A |
| US3BF | US3B |
| US3DF | US3D |
| US3GF | US3G |
| US3JF | US3J |
| US3KF | US3K |
| US3MF | US3M |

| Parameter | Symbols | US3AF | US3BF | US3DF | US3GF | US3JF | US3KF | US3MF | Units |
|---|---------------------------------|------------|-------|-------|-------|-------|-------|-------|--------------------|
| Maximum Repetitive Peak Reverse Voltage | V_{RRM} | 50 | 100 | 200 | 400 | 600 | 800 | 1000 | V |
| Maximum RMS voltage | V_{RMS} | 35 | 70 | 140 | 280 | 420 | 560 | 700 | V |
| Maximum DC Blocking Voltage | V_{DC} | 50 | 100 | 200 | 400 | 600 | 800 | 1000 | V |
| Maximum Average Forward Rectified Current at $T_c = 125\text{ }^\circ\text{C}$ | $I_{F(AV)}$ | 3 | | | | | | | A |
| Peak Forward Surge Current 8.3 ms Single Half Sine Wave Superimposed on Rated Load | I_{FSM} | 100 | | | | | | | A |
| Maximum Instantaneous Forward Voltage at 3 A | V_F | 0.95 | | 1.25 | | 1.65 | | V | |
| Maximum DC Reverse Current $T_a = 25\text{ }^\circ\text{C}$ at Rated DC Blocking Voltage $T_a = 125\text{ }^\circ\text{C}$ | I_R | 5 100 | | | | | | | μA |
| Maximum Reverse Recovery Time ⁽¹⁾ | T_{rr} | 50 | | | | 75 | | | nS |
| Typical Thermal Resistance ⁽²⁾ | $R_{\theta JA} / R_{\theta JC}$ | 50/12 | | | | | | | $^\circ\text{C/W}$ |
| Operating and Storage Temperature Range | T_j, T_{stg} | -55 ~ +150 | | | | | | | $^\circ\text{C}$ |

(1) Measured with $I_F=0.5\text{A}, I_R=1\text{A}, I_n=0.25\text{A}$

(2) P.C.B. mounted with 2.0" X 2.0" (5 X 5 cm) copper pad areas.

Fig.1 Maximum Average Forward Current Rating

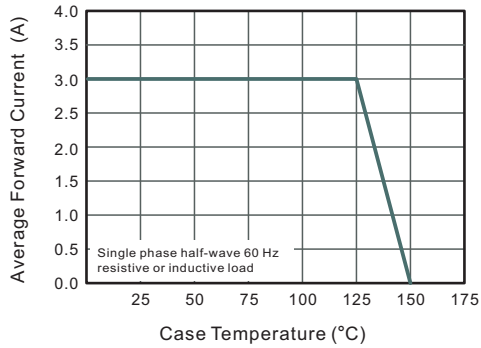

Fig.2 Typical Reverse Characteristics

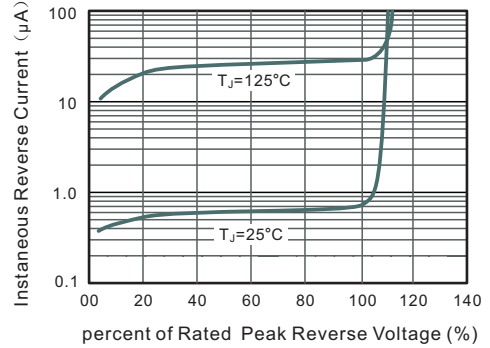

Fig.3 Typical Forward Characteristics

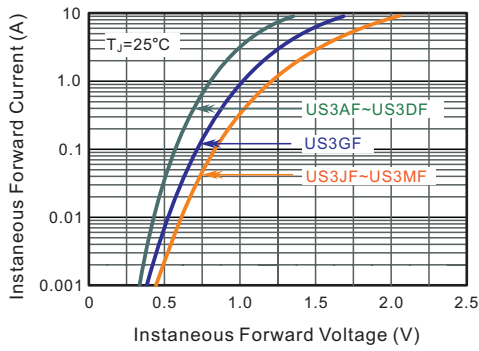
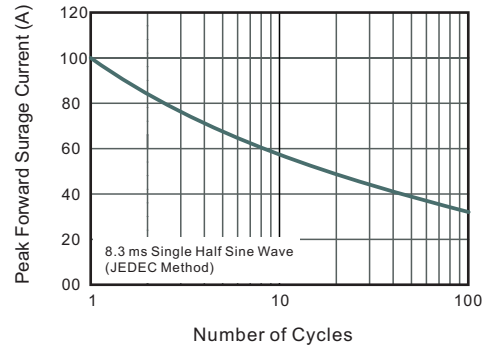

Fig.4 Maximum Non-Repetitive Peak Forward Surge Current



Package Outline

SMAF

Plastic surface mounted package; 2 leads

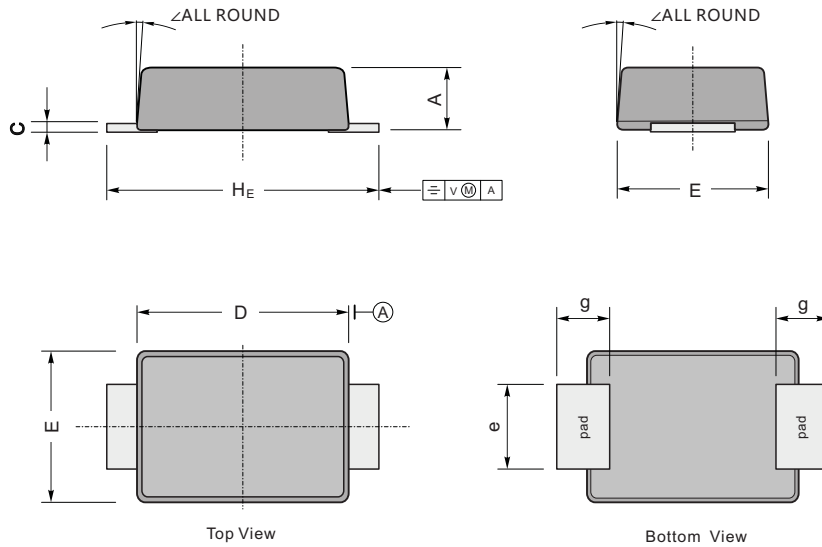

| UNIT | | A | C | D | E | e | g | H _E | \angle |
|------|-----|-----|------|-----|-----|-----|-----|----------------|----------|
| mm | max | 1.1 | 0.20 | 3.7 | 2.7 | 1.6 | 1.2 | 4.9 | 7° |
| | min | 0.9 | 0.12 | 3.3 | 2.4 | 1.3 | 0.8 | 4.4 | |
| mil | max | 43 | 7.9 | 146 | 106 | 63 | 47 | 193 | |
| | min | 35 | 4.7 | 130 | 94 | 51 | 31 | 173 | |

The recommended mounting pad size

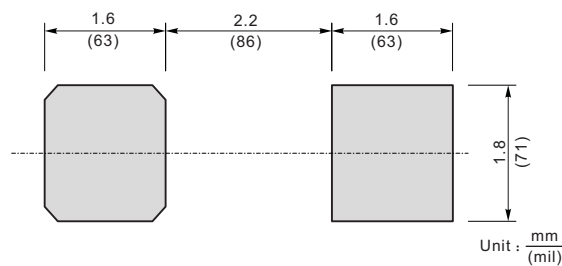

Summary of Packing Options

| Package | Packing Description | Packing Quantity | Industry Standard |
|---------|---------------------|------------------|-------------------|
| SMAF | Tape/Reel, 13" reel | 10000 | EIA-481-1 |
| | Tape/Reel, 7" reel | 3000 | EIA-481-1 |