

## Surface Mount Ultrafast Recovery Rectifier

Reverse Voltage - 50 to 1000 V

Forward Current - 1 A

### FEATURES

- ◆ For surface mounted applications
- ◆ Low profile package
- ◆ Glass Passivated Chip Junction
- ◆ High efficiency
- ◆ Lead free in comply with EU RoHS 2011/65/EU directives

### MECHANICAL DATA

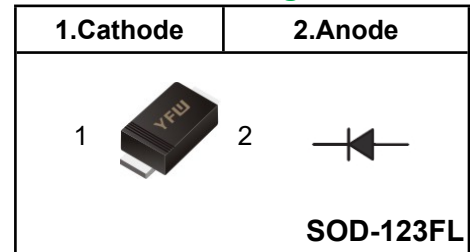
- ◆ Case: SOD-123FL
- ◆ Terminals: Solderable per MIL-STD-750, Method 2026
- ◆ Approx. Weight: 15mg / 0.00053oz

### Maximum Ratings and characteristics

Ratings at 25 °C ambient temperature unless otherwise specified.

Single phase half-wave 60 Hz, resistive or inductive load, for capacitive load current derate by 20 %.

### Pinning



### Marking Code

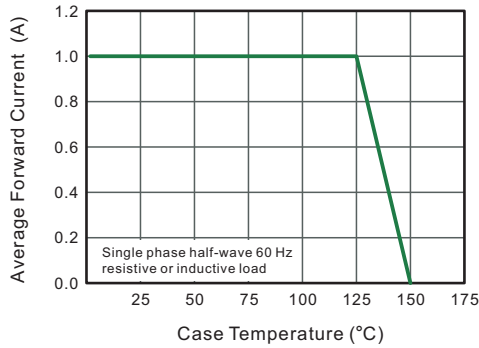
<b>US1AW</b>	<b>U1A</b>
<b>US1BW</b>	<b>U1B</b>
<b>US1DW</b>	<b>U1D</b>
<b>US1GW</b>	<b>U1G</b>
<b>US1JW</b>	<b>U1J</b>
<b>US1KW</b>	<b>U1K</b>
<b>US1MW</b>	<b>U1M</b>

Parameter	Symbols	US1AW	US1BW	US1DW	US1GW	US1JW	US1KW	US1MW	Units
Maximum Repetitive Peak Reverse Voltage	$V_{RRM}$	50	100	200	400	600	800	1000	V
Maximum RMS voltage	$V_{RMS}$	35	70	140	280	420	560	700	V
Maximum DC Blocking Voltage	$V_{DC}$	50	100	200	400	600	800	1000	V
Maximum Average Forward Rectified Current at $T_c = 125\text{ }^\circ\text{C}$	$I_{F(AV)}$	1							A
Peak Forward Surge Current 8.3 ms Single Half Sine Wave Superimposed on Rated Load	$I_{FSM}$	30							A
Maximum Instantaneous Forward Voltage at 1 A	$V_F$	0.95			1.25	1.65			V
Maximum DC Reverse Current $T_a = 25\text{ }^\circ\text{C}$ at Rated DC Blocking Voltage $T_a = 125\text{ }^\circ\text{C}$	$I_R$	5 100							$\mu\text{A}$
Maximum Reverse Recovery Time <sup>(1)</sup>	$T_{rr}$	50				75			nS
Typical Thermal Resistance <sup>(2)</sup>	$R_{\theta JA}$	85							$^\circ\text{C/W}$
Operating and Storage Temperature Range	$T_j, T_{stg}$	-55 ~ +150							$^\circ\text{C}$

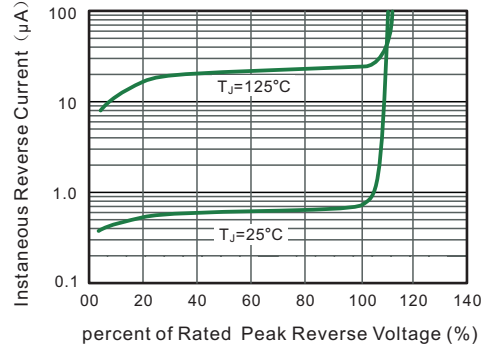
(1) Measured with  $I_F=0.5\text{A}, I_R=1\text{A}, I_n=0.25\text{A}$

(2) P.C.B. mounted with 2.0" X 2.0" (5 X 5 cm) copper pad areas.

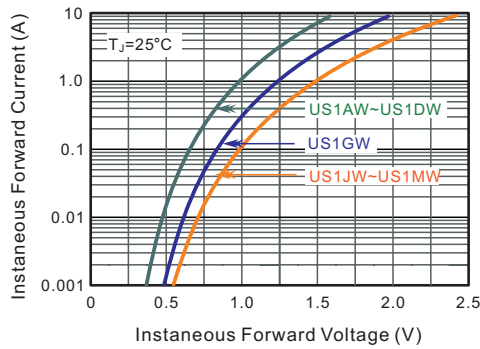
**Fig.1 Forward Current Derating Curve**



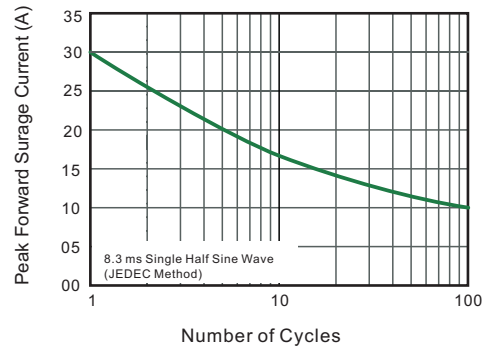
**Fig.2 Typical Reverse Characteristics**



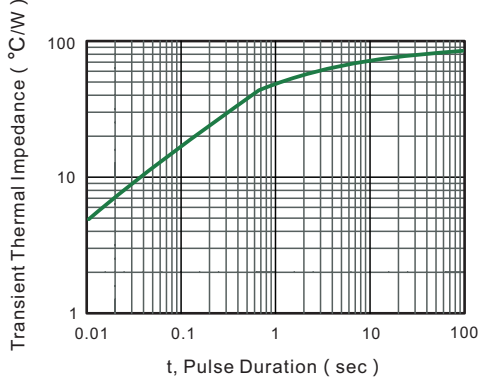
**Fig.3 Typical Forward Characteristics**



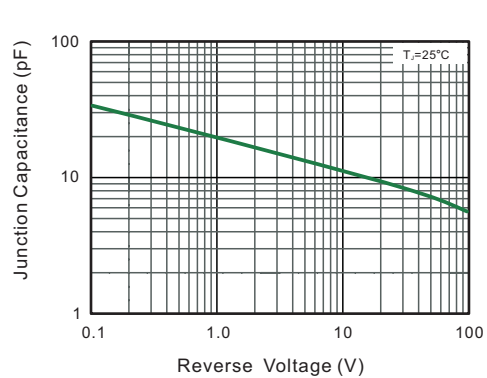
**Fig.4 Maximum Non-Repetitive Peak Forward Surge Current**



**Fig.5- Typical Transient Thermal Impedance**

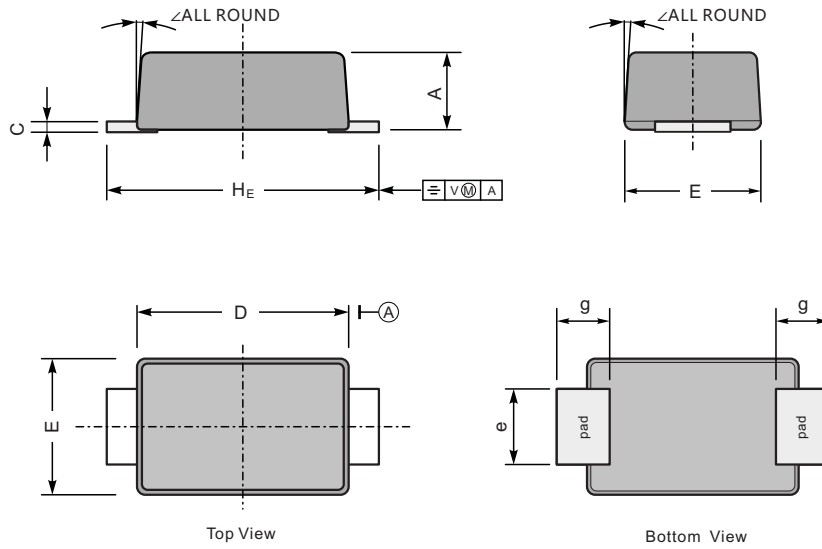


**Fig.6 Typical Junction Capacitance**



**Package Outline SOD-123FL**

Plastic surface mounted package; 2 leads



UNIT		A	C	D	E	e	g	H <sub>E</sub>	$\angle$
mm	max	1.3	0.20	2.9	1.9	1.1	0.9	3.8	7°
	min	0.9	0.12	2.6	1.7	0.8	0.7	3.5	
mil	max	43	7.9	114	75	43	35	150	
	min	35	4.7	102	67	31	28	138	

**The recommended mounting pad size**



Unit:  $\frac{\text{mm}}{\text{mil}}$

**Summary of Packing Options**

Package	Packing Description	Packing Quantity	Industry Standard
SOD-123FL	Tape/Reel, 13" reel	10000	EIA-481-1
	Tape/Reel, 7" reel	3000	EIA-481-1