

Self-Protected Low Side Driver with Temperature and Current Limit

65 V, 7.0 A, Single N-Channel



ON Semiconductor®

www.onsemi.com

NCV8406A, NCV8406B

NCV8406A/B is a three terminal protected Low-Side Smart Discrete device. The protection features include overcurrent, overtemperature, ESD and integrated Drain-to-Gate clamping for overvoltage protection. This device offers protection and is suitable for harsh automotive environments.

Features

- Short Circuit Protection
- Thermal Shutdown with Automatic Restart
- Over Voltage Protection
- Integrated Clamp for Inductive Switching
- ESD Protection
- dV/dt Robustness
- Analog Drive Capability (Logic Level Input)
- These Devices are Faster than the Rest of the NCV Devices
- NCV Prefix for Automotive and Other Applications Requiring Unique Site and Control Change Requirements; AEC-Q101 Qualified and PPAP Capable
- These Devices are Pb-Free, Halogen Free/BFR Free and are RoHS Compliant

Typical Applications

- Switch a Variety of Resistive, Inductive and Capacitive Loads
- Can Replace Electromechanical Relays and Discrete Circuits
- Automotive / Industrial

V _{DSS} (Clamped)	R _{DS(on)} TYP	I _D TYP (Limited)
65 V	210 mΩ	7.0 A

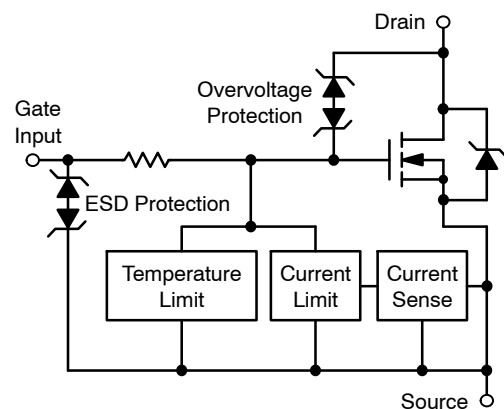

MARKING DIAGRAM

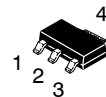

SOT-223
CASE 318E
STYLE 3

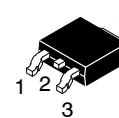
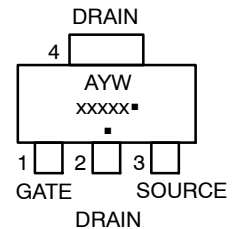

DPAK
CASE 369C

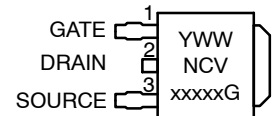

A = Assembly Location
Y = Year
W, WW = Work Week
xxxxx = 8406A or 8406B
G or ■ = Pb-Free Package

(Note: Microdot may be in either location)

ORDERING INFORMATION

See detailed ordering and shipping information in the package dimensions section on page 10 of this data sheet.

NCV8406A, NCV8406B

MAXIMUM RATINGS ($T_J = 25^\circ\text{C}$ unless otherwise noted)

Rating	Symbol	Value	Unit
Drain-to-Source Voltage Internally Clamped	V_{DSS}	60	Vdc
Gate-to-Source Voltage	V_{GS}	± 14	Vdc
Drain Current	I_D	Internally Limited	
Total Power Dissipation – SOT-223 Version @ $T_A = 25^\circ\text{C}$ (Note 1) @ $T_A = 25^\circ\text{C}$ (Note 2)	P_D	1.25 1.81	W
Total Power Dissipation – DPAK Version @ $T_A = 25^\circ\text{C}$ (Note 1) @ $T_A = 25^\circ\text{C}$ (Note 2)	P_D	1.31 2.31	W
Thermal Resistance – SOT-223 Version Junction-to-Soldering Point Junction-to-Ambient (Note 1) Junction-to-Ambient (Note 2)	$R_{\theta JS}$ $R_{\theta JA}$ $R_{\theta JA}$	7.0 100 69	$^\circ\text{C/W}$
Thermal Resistance – DPAK Version Junction-to-Soldering Point Junction-to-Ambient (Note 1) Junction-to-Ambient (Note 2)	$R_{\theta JS}$ $R_{\theta JA}$ $R_{\theta JA}$	1.0 95 54	$^\circ\text{C/W}$
Single Pulse Inductive Load Switching Energy (Starting $T_J = 25^\circ\text{C}$, $V_{DD} = 50\text{ Vdc}$, $V_{GS} = 5.0\text{ Vdc}$, $I_L = 2.1\text{ Apk}$, $L = 50\text{ mH}$, $R_G = 25\ \Omega$)	E_{AS}	110	mJ
Load Dump Voltage ($V_{GS} = 0$ and 10 V , $R_I = 2\ \Omega$, $R_L = 7\ \Omega$, $t_d = 400\text{ ms}$)	V_{LD}	75	V
Operating Junction Temperature Range	T_J	-40 to 150	$^\circ\text{C}$
Storage Temperature Range	T_{stg}	-55 to 150	$^\circ\text{C}$

Stresses exceeding those listed in the Maximum Ratings table may damage the device. If any of these limits are exceeded, device functionality should not be assumed, damage may occur and reliability may be affected.

1. Surface mounted onto minimum pad size (100 sq/mm) FR4 PCB, 1 oz cu.
2. Mounted onto 1" square pad size (700 sq/mm) FR4 PCB, 1 oz cu.

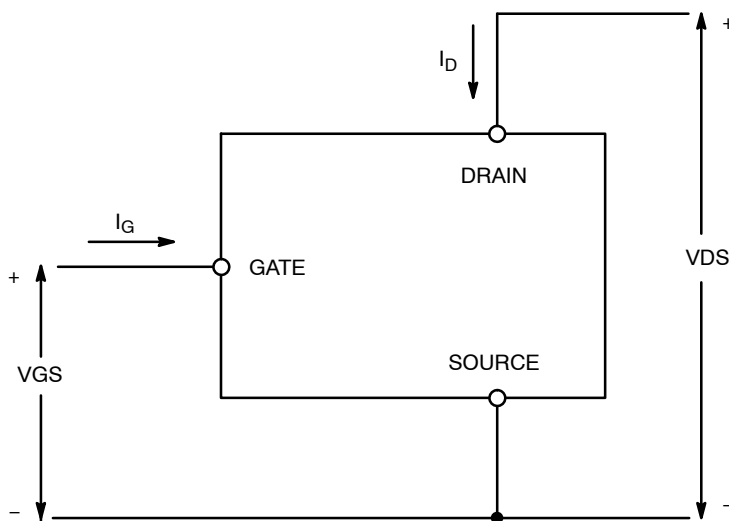

Figure 1. Voltage and Current Convention

NCV8406A, NCV8406B

MOSFET ELECTRICAL CHARACTERISTICS (T_J = 25°C unless otherwise noted)

Characteristic	Symbol	Min	Typ	Max	Unit
----------------	--------	-----	-----	-----	------

OFF CHARACTERISTICS

Drain-to-Source Clamped Breakdown Voltage (V _{GS} = 0 V, I _D = 2 mA)	V _{(BR)DSS}	60	65	70	V
Zero Gate Voltage Drain Current (V _{DS} = 52 V, V _{GS} = 0 V)	I _{DSS}	-	22	100	μA
Gate Input Current (V _{GS} = 5.0 V, V _{DS} = 0 V)	I _{GSS}	-	30	100	μA

ON CHARACTERISTICS

Gate Threshold Voltage (V _{DS} = V _{GS} , I _D = 150 μA) Threshold Temperature Coefficient	V _{GS(th)}	1.2 -	1.66 4.0	2.0 -	V -mV/°C
Static Drain-to-Source On-Resistance (Note 3) (V _{GS} = 10 V, I _D = 2.0 A, T _J @ 25°C)	R _{DS(on)}	-	185	210	mΩ
Static Drain-to-Source On-Resistance (Note 3) (V _{GS} = 5.0 V, I _D = 2.0 A, T _J @ 25°C) (V _{GS} = 5.0 V, I _D = 2.0 A, T _J @ 150°C)	R _{DS(on)}	-	210 445	240 520	mΩ
Source-Drain Forward On Voltage (I _S = 7.0 A, V _{GS} = 0 V)	V _{SD}	-	0.9	1.1	V

SWITCHING CHARACTERISTICS (Note 6)

Turn-on Delay Time	R _L = 6.6 Ω, V _{in} = 0 to 10 V, V _{DD} = 13.8 V, I _D = 2.0 A, 10% V _{in} to 10% I _D	t _{d(on)}	-	127	-	ns
Turn-on Rise Time	R _L = 6.6 Ω, V _{in} = 0 to 10 V, V _{DD} = 13.8 V, I _D = 2.0 A, 10% I _D to 90% I _D	t _{rise}	-	486	-	ns
Turn-off Delay Time	R _L = 6.6 Ω, V _{in} = 0 to 10 V, V _{DD} = 13.8 V, I _D = 2.0 A, 90% V _{in} to 90% I _D	t _{d(off)}	-	1600	-	ns
Turn-off Fall Time	R _L = 6.6 Ω, V _{in} = 0 to 10 V, V _{DD} = 13.8 V, I _D = 2.0 A, 90% I _D to 10% I _D	t _{fall}	-	692	-	ns
Slew Rate ON	R _L = 6.6 Ω, V _{in} = 0 to 10 V, V _{DD} = 13.8 V, I _D = 2.0 A, 70% to 50% V _{DD}	dV _{DS} /dT _{on}	-	79	-	V/μs
Slew Rate OFF	R _L = 6.6 Ω, V _{in} = 0 to 10 V, V _{DD} = 13.8 V, I _D = 2.0 A, 50% to 70% V _{DD}	dV _{DS} /dT _{off}	-	27	-	V/μs

SELF PROTECTION CHARACTERISTICS (Note 4)

Current Limit	V _{DS} = 10 V, V _{GS} = 5.0 V, T _J = 25°C (Note 5) V _{DS} = 10 V, V _{GS} = 5.0 V, T _J = 150°C (Notes 5, 6) V _{DS} = 10 V, V _{GS} = 10 V, T _J = 25°C (Notes 5)	I _{LIM}	5.0 3.5 6.5	7.0 4.5 8.5	9.5 6.0 10.5	A
Temperature Limit (Turn-off)	V _{GS} = 5.0 V (Note 6)	T _{LIM(off)}	150	180	200	°C
Thermal Hysteresis	V _{GS} = 5.0 V	ΔT _{LIM(on)}	-	10	-	°C
Temperature Limit (Turn-off)	V _{GS} = 10 V (Note 6)	T _{LIM(off)}	150	180	200	°C
Thermal Hysteresis	V _{GS} = 10 V	ΔT _{LIM(on)}	-	20	-	°C
Input Current during Thermal Fault	V _{DS} = 0 V, V _{GS} = 5.0 V, T _J = T _J > T _(fault) (Note 6) V _{DS} = 0 V, V _{GS} = 10 V, T _J = T _J > T _(fault) (Note 6)	I _{g(fault)}	-	5.9 12.3	-	mA

ESD ELECTRICAL CHARACTERISTICS

Electro-Static Discharge Capability Human Body Model (HBM) Machine Model (MM)	ESD	6000 500	-	-	-	V
---	-----	-------------	---	---	---	---

Product parametric performance is indicated in the Electrical Characteristics for the listed test conditions, unless otherwise noted. Product performance may not be indicated by the Electrical Characteristics if operated under different conditions.

3. Pulse Test: Pulse Width ≤ 300 μs, Duty Cycle ≤ 2%.
4. Fault conditions are viewed as beyond the normal operating range of the part.
5. Current limit measured at 380 μs after gate pulse.
6. Not subject to production test.

TYPICAL PERFORMANCE CURVES

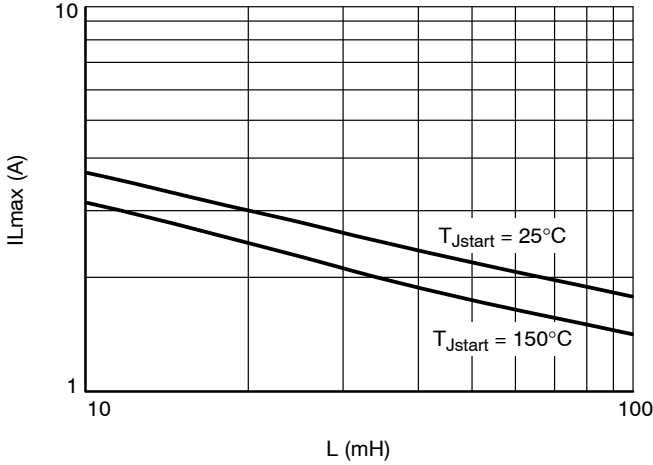

Figure 2. Single Pulse Maximum Switch-off Current vs. Load Inductance

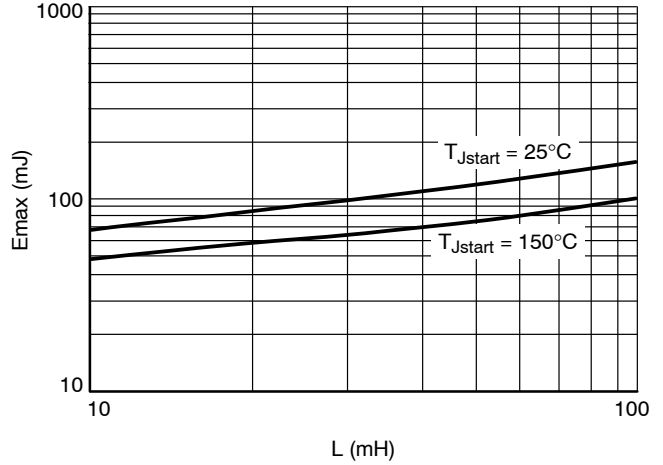

Figure 3. Single-Pulse Maximum Switching Energy vs. Load Inductance

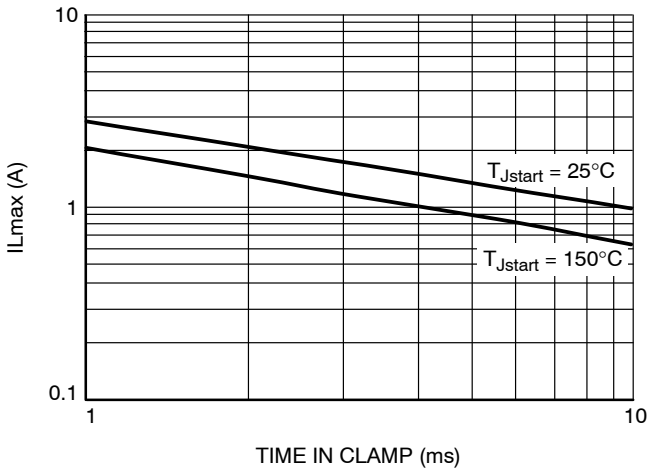

Figure 4. Single Pulse Maximum Inductive Switch-off Current vs. Time in Clamp

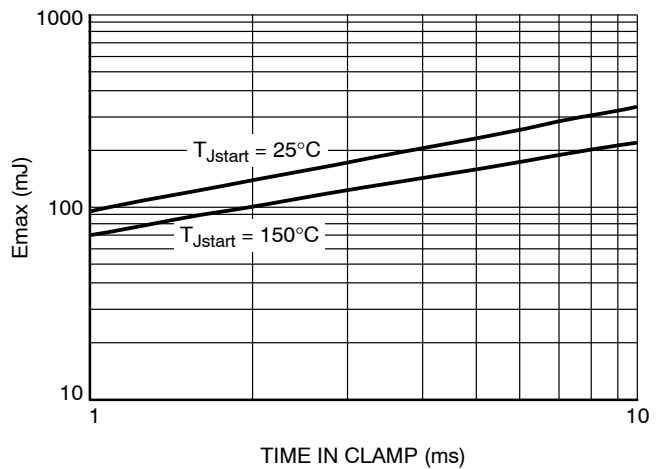

Figure 5. Single-Pulse Maximum Inductive Switching Energy vs. Time in Clamp

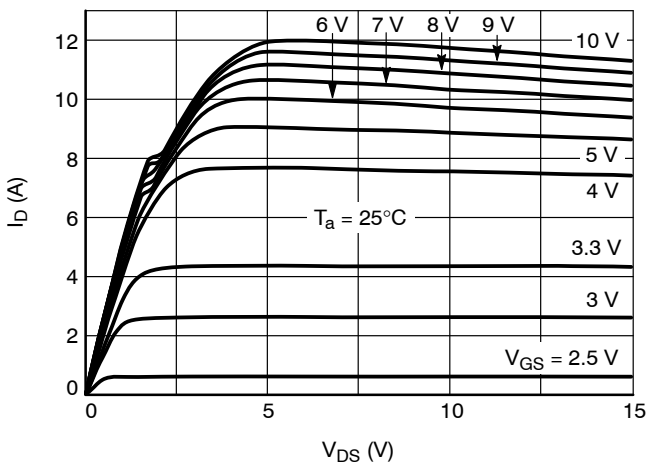

Figure 6. On-state Output Characteristics

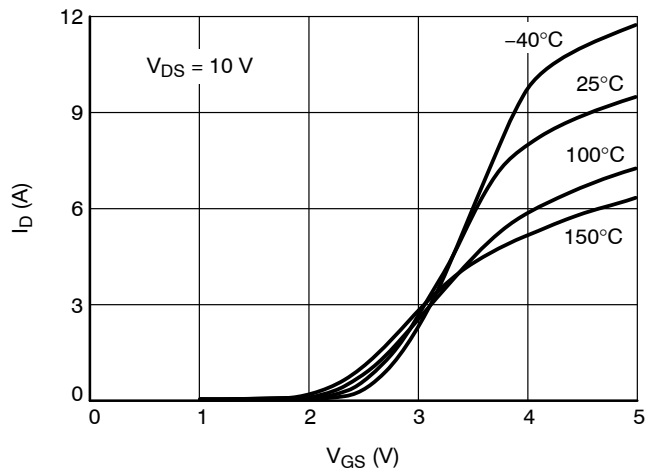

Figure 7. Transfer Characteristics

TYPICAL PERFORMANCE CURVES

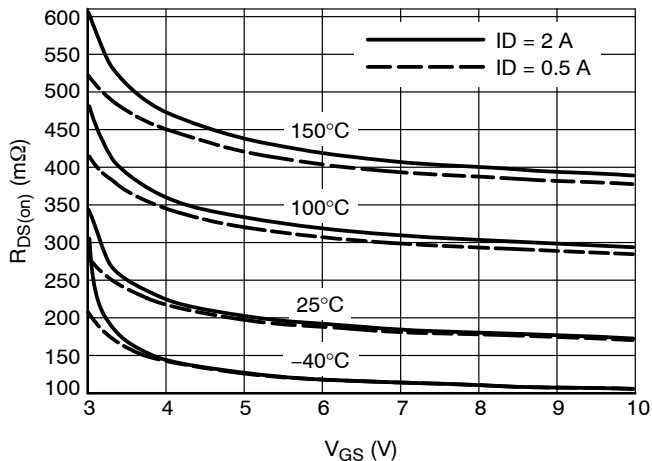

Figure 8. $R_{DS(on)}$ vs. Gate-Source Voltage

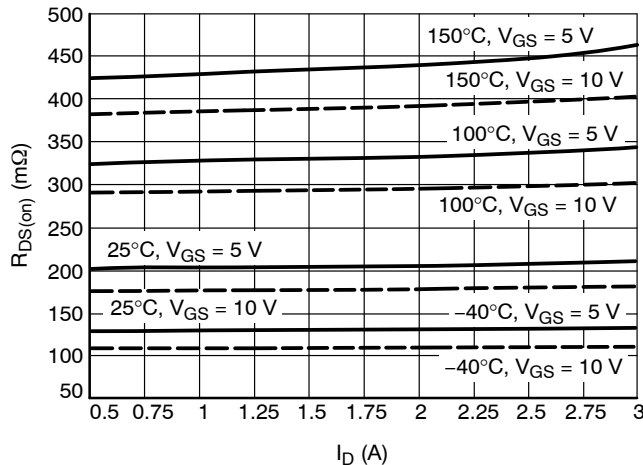

Figure 9. $R_{DS(on)}$ vs. Drain Current

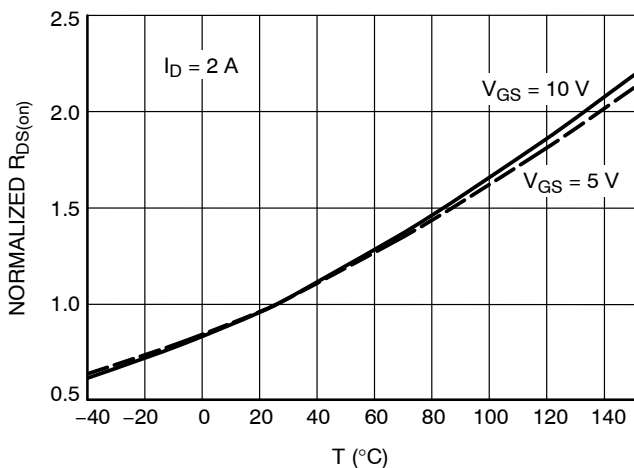

Figure 10. Normalized $R_{DS(on)}$ vs. Temperature

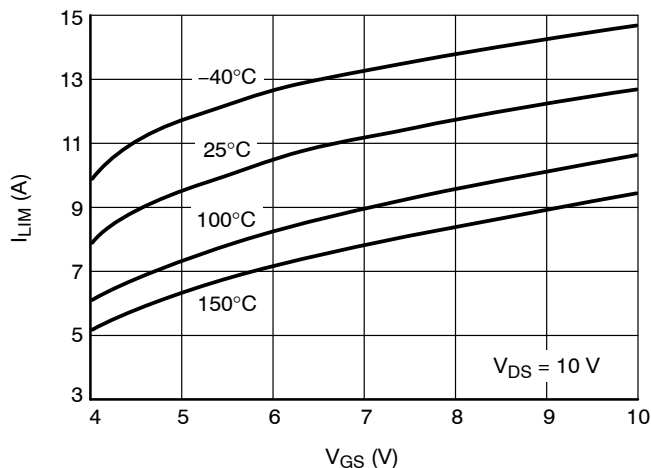

Figure 11. Current Limit vs. Gate-Source Voltage

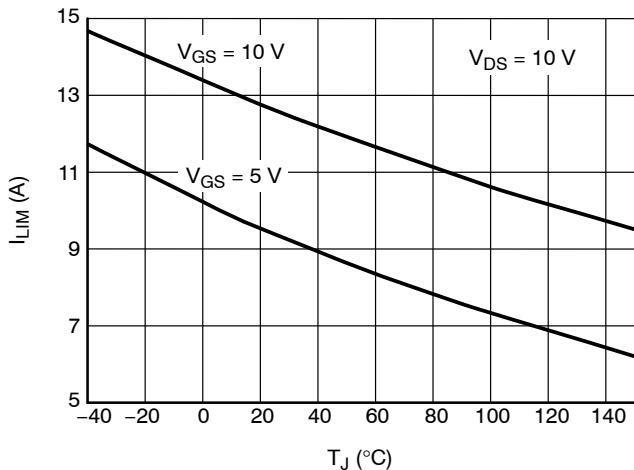

Figure 12. Current Limit vs. Junction Temperature

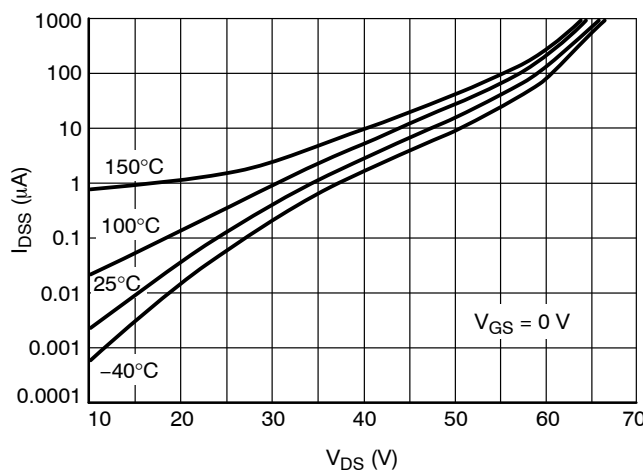

Figure 13. Drain-to-Source Leakage Current

TYPICAL PERFORMANCE CURVES

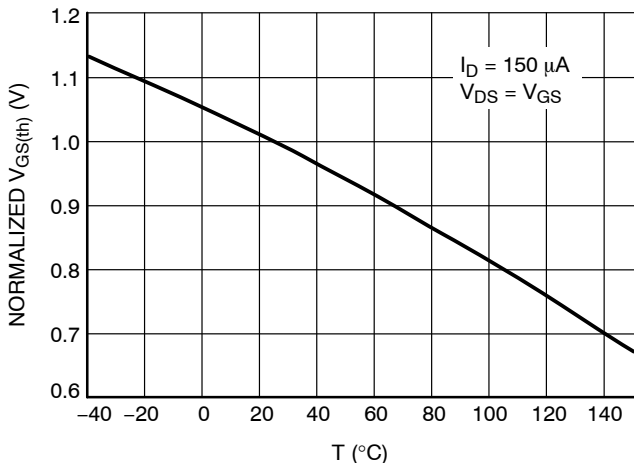

Figure 14. Normalized Threshold Voltage vs. Temperature

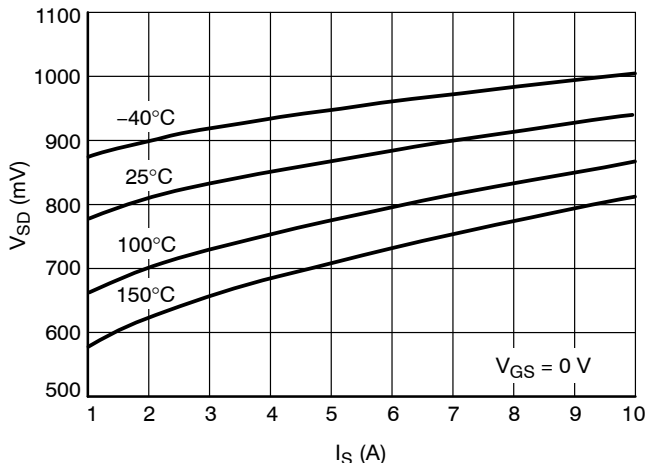

Figure 15. Source-Drain Diode Forward Characteristics

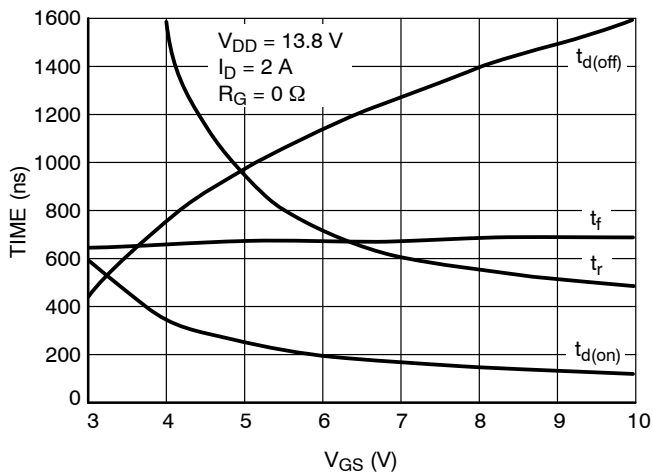

Figure 16. Resistive Load Switching Time vs. Gate-Source Voltage

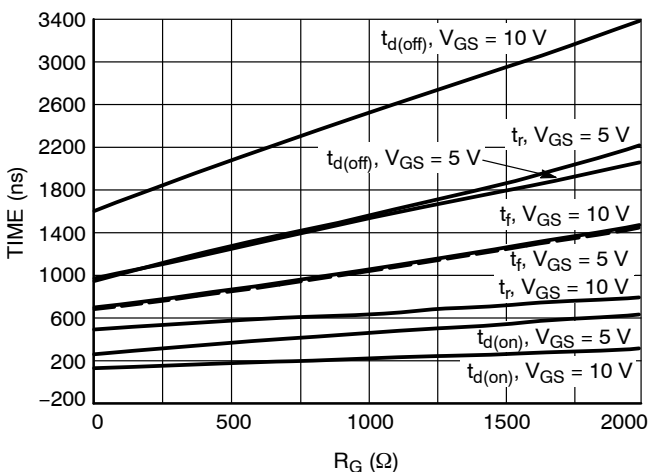

Figure 17. Resistive Load Switching Time vs. Gate Resistance

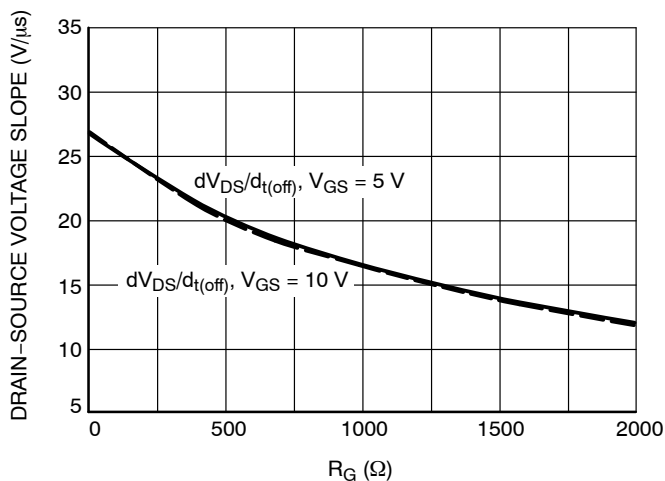

Figure 18. Drain-Source Voltage Slope during Turn On and Turn Off vs. Gate Resistance

TYPICAL PERFORMANCE CURVES

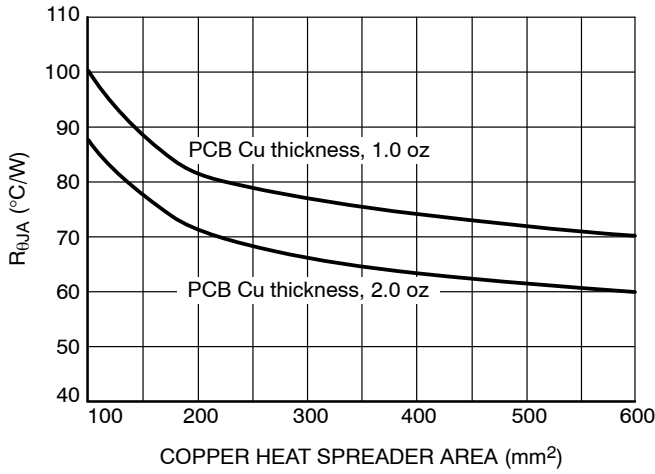

Figure 19. $R_{\theta JA}$ vs. Copper Area – SOT-223

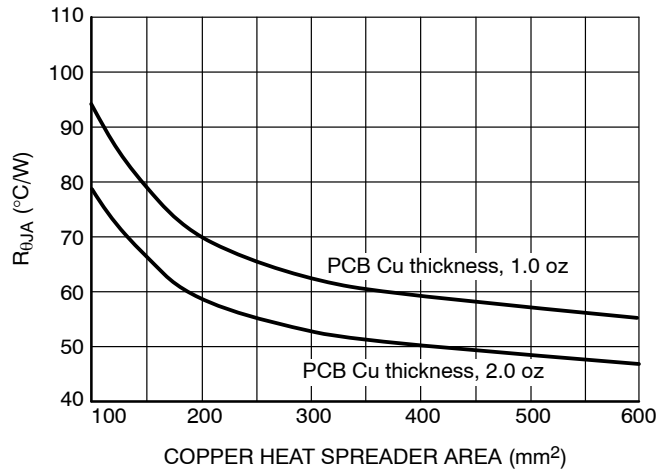

Figure 20. $R_{\theta JA}$ vs. Copper Area – DPAK

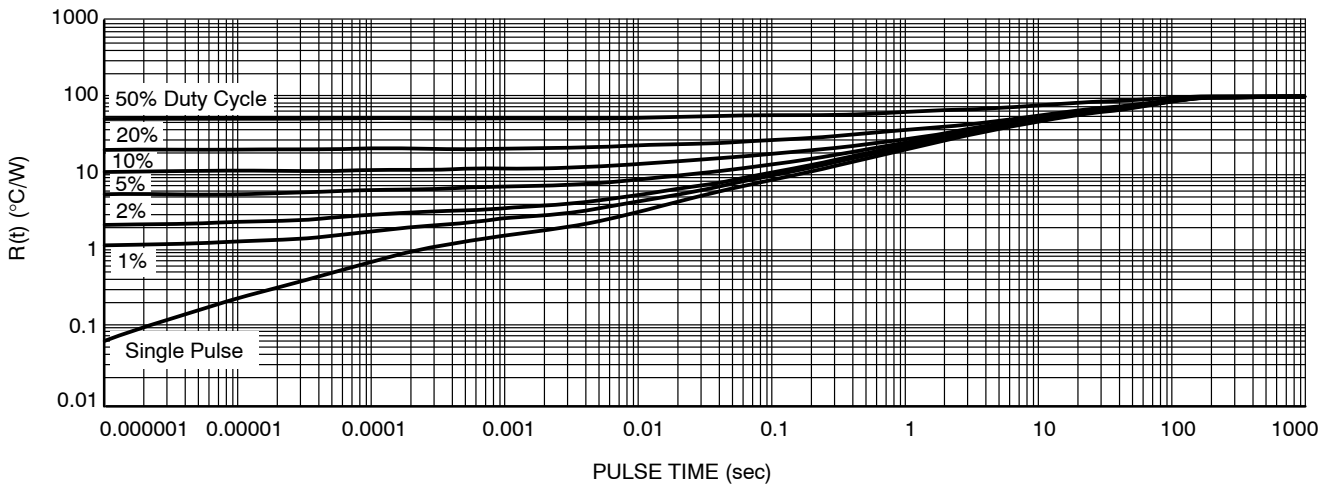

Figure 21. Transient Thermal Resistance – SOT-223 Version

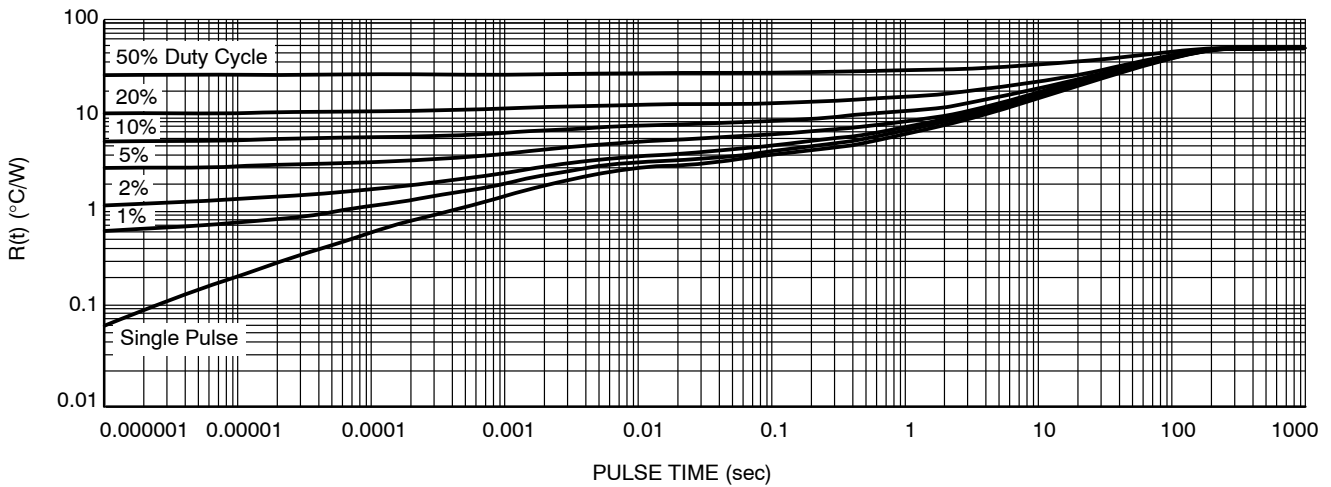

Figure 22. Transient Thermal Resistance – DPAK Version

NCV8406A, NCV8406B

TEST CIRCUITS AND WAVEFORMS

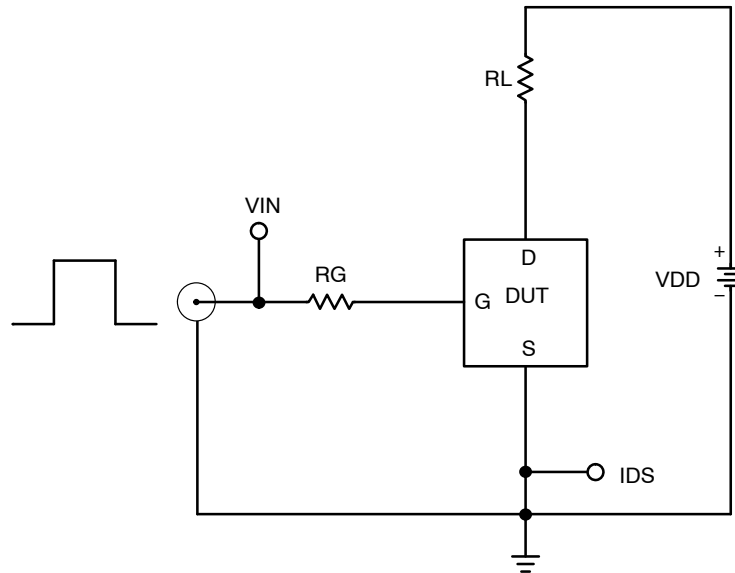

Figure 23. Resistive Load Switching Test Circuit

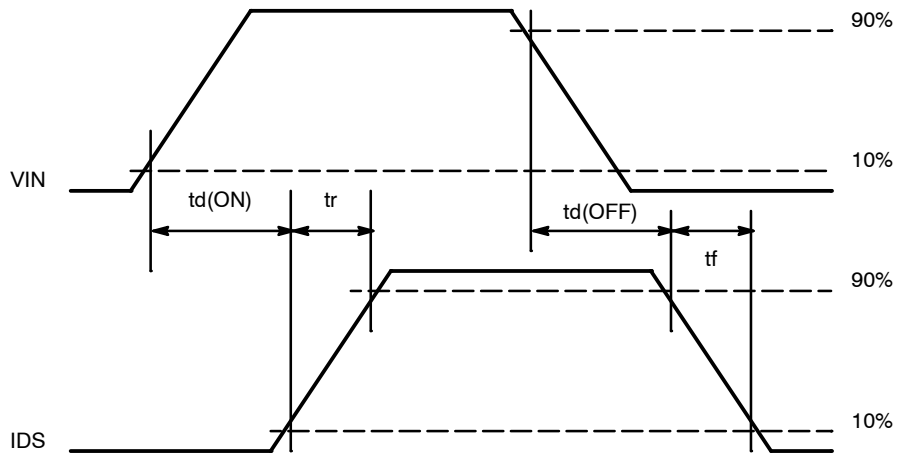

Figure 24. Resistive Load Switching Waveforms

NCV8406A, NCV8406B

TEST CIRCUITS AND WAVEFORMS

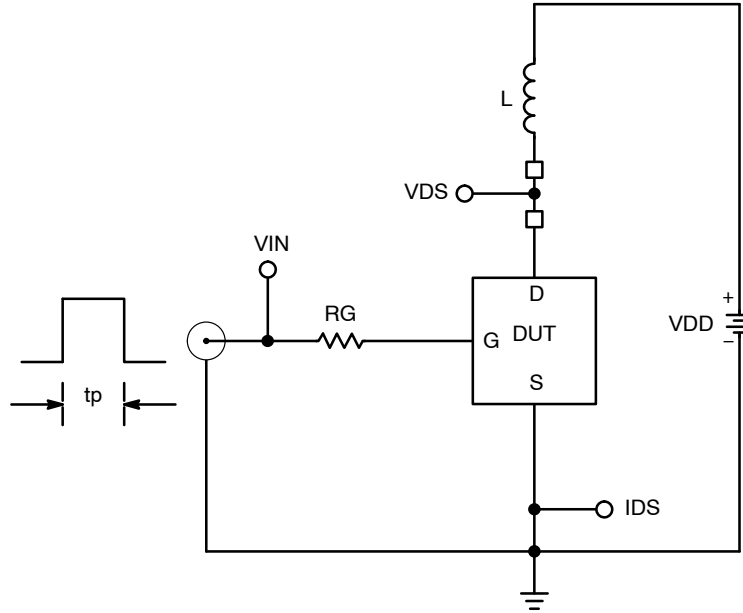

Figure 25. Inductive Load Switching Test Circuit

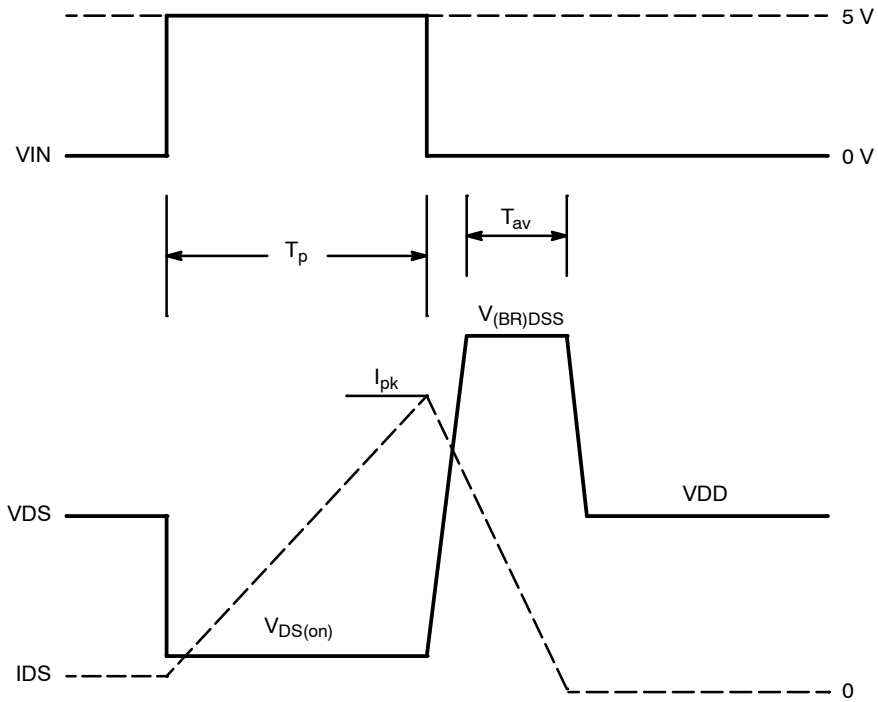

Figure 26. Inductive Load Switching Waveforms

NCV8406A, NCV8406B

ORDERING INFORMATION

Device	Package	Shipping†
NCV8406ASTT1G	SOT-223 (Pb-Free)	1000 / Tape & Reel
NCV8406ASTT3G	SOT-223 (Pb-Free)	4000 / Tape & Reel
NCV8406ADTRKG	DPAK (Pb-Free)	2500 / Tape & Reel
NCV8406BDTRKG	DPAK (Pb-Free)	2500 / Tape & Reel

†For information on tape and reel specifications, including part orientation and tape sizes, please refer to our Tape and Reel Packaging Specifications Brochure, BRD8011/D.

MECHANICAL CASE OUTLINE

PACKAGE DIMENSIONS

ON Semiconductor®

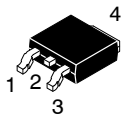

SCALE 1:1

DPAK (SINGLE GAUGE) CASE 369C ISSUE F

DATE 21 JUL 2015

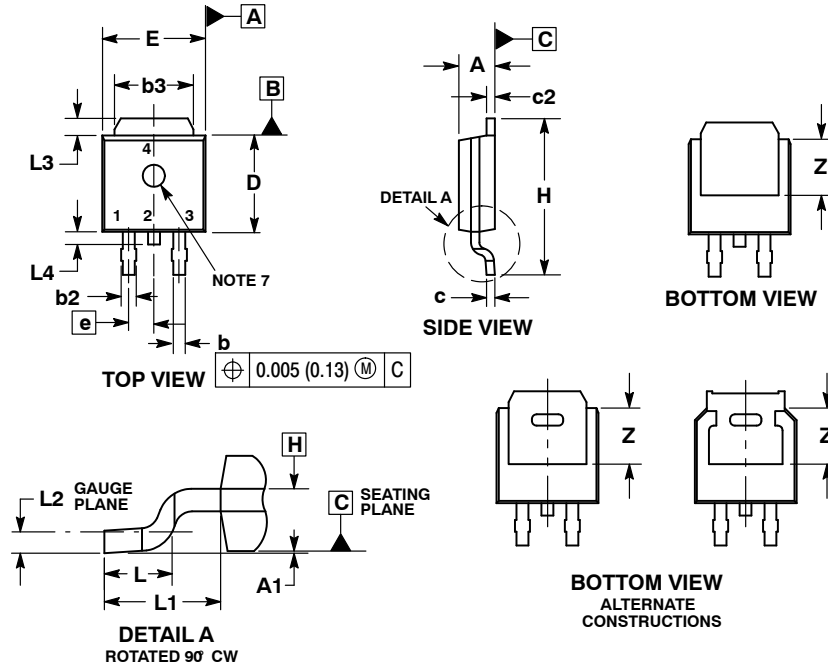

NOTES:

1. DIMENSIONING AND TOLERANCING PER ASME Y14.5M, 1994.
2. CONTROLLING DIMENSION: INCHES.
3. THERMAL PAD CONTOUR OPTIONAL WITHIN DIMENSIONS b3, L3 and Z.
4. DIMENSIONS D AND E DO NOT INCLUDE MOLD FLASH, PROTRUSIONS, OR BURRS. MOLD FLASH, PROTRUSIONS, OR GATE BURRS SHALL NOT EXCEED 0.006 INCHES PER SIDE.
5. DIMENSIONS D AND E ARE DETERMINED AT THE OUTERMOST EXTREMES OF THE PLASTIC BODY.
6. DATUMS A AND B ARE DETERMINED AT DATUM PLANE H.
7. OPTIONAL MOLD FEATURE.

DIM	INCHES		MILLIMETERS	
	MIN	MAX	MIN	MAX
A	0.086	0.094	2.18	2.38
A1	0.000	0.005	0.00	0.13
b	0.025	0.035	0.63	0.89
b2	0.028	0.045	0.72	1.14
b3	0.180	0.215	4.57	5.46
c	0.018	0.024	0.46	0.61
c2	0.018	0.024	0.46	0.61
D	0.235	0.245	5.97	6.22
E	0.250	0.265	6.35	6.73
e	0.090 BSC		2.29 BSC	
H	0.370	0.410	9.40	10.41
L	0.055	0.070	1.40	1.78
L1	0.114 REF		2.90 REF	
L2	0.020 BSC		0.51 BSC	
L3	0.035	0.050	0.89	1.27
L4	---	0.040	---	1.01
Z	0.155	---	3.93	---

GENERIC MARKING DIAGRAM*

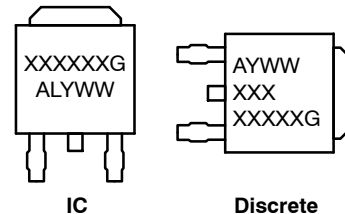

- XXXXXX = Device Code
- A = Assembly Location
- L = Wafer Lot
- Y = Year
- WW = Work Week
- G = Pb-Free Package

*This information is generic. Please refer to device data sheet for actual part marking.

- | | | | | |
|--|--|---|---|--|
| <p>STYLE 1:
PIN 1. BASE
2. COLLECTOR
3. EMITTER
4. COLLECTOR</p> | <p>STYLE 2:
PIN 1. GATE
2. DRAIN
3. SOURCE
4. DRAIN</p> | <p>STYLE 3:
PIN 1. ANODE
2. CATHODE
3. ANODE
4. CATHODE</p> | <p>STYLE 4:
PIN 1. CATHODE
2. ANODE
3. GATE
4. ANODE</p> | <p>STYLE 5:
PIN 1. GATE
2. ANODE
3. CATHODE
4. ANODE</p> |
| <p>STYLE 6:
PIN 1. MT1
2. MT2
3. GATE
4. MT2</p> | <p>STYLE 7:
PIN 1. GATE
2. COLLECTOR
3. EMITTER
4. COLLECTOR</p> | <p>STYLE 8:
PIN 1. N/C
2. CATHODE
3. ANODE
4. CATHODE</p> | <p>STYLE 9:
PIN 1. ANODE
2. CATHODE
3. RESISTOR ADJUST
4. CATHODE</p> | <p>STYLE 10:
PIN 1. CATHODE
2. ANODE
3. CATHODE
4. ANODE</p> |

SOLDERING FOOTPRINT*

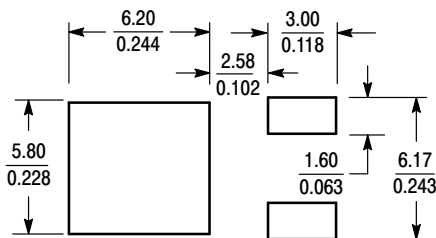

SCALE 3:1 (mm / inches)

*For additional information on our Pb-Free strategy and soldering details, please download the ON Semiconductor Soldering and Mounting Techniques Reference Manual, SOLDERRM/D.

DOCUMENT NUMBER:	98AON10527D	Electronic versions are uncontrolled except when accessed directly from the Document Repository. Printed versions are uncontrolled except when stamped "CONTROLLED COPY" in red.
DESCRIPTION:	DPAK (SINGLE GAUGE)	PAGE 1 OF 1

ON Semiconductor and ON are trademarks of Semiconductor Components Industries, LLC dba ON Semiconductor or its subsidiaries in the United States and/or other countries. ON Semiconductor reserves the right to make changes without further notice to any products herein. ON Semiconductor makes no warranty, representation or guarantee regarding the suitability of its products for any particular purpose, nor does ON Semiconductor assume any liability arising out of the application or use of any product or circuit, and specifically disclaims any and all liability, including without limitation special, consequential or incidental damages. ON Semiconductor does not convey any license under its patent rights nor the rights of others.

onsemi, **Onsemi**, and other names, marks, and brands are registered and/or common law trademarks of Semiconductor Components Industries, LLC dba "**onsemi**" or its affiliates and/or subsidiaries in the United States and/or other countries. **onsemi** owns the rights to a number of patents, trademarks, copyrights, trade secrets, and other intellectual property. A listing of **onsemi**'s product/patent coverage may be accessed at www.onsemi.com/site/pdf/Patent-Marking.pdf. **onsemi** reserves the right to make changes at any time to any products or information herein, without notice. The information herein is provided "as-is" and **onsemi** makes no warranty, representation or guarantee regarding the accuracy of the information, product features, availability, functionality, or suitability of its products for any particular purpose, nor does **onsemi** assume any liability arising out of the application or use of any product or circuit, and specifically disclaims any and all liability, including without limitation special, consequential or incidental damages. Buyer is responsible for its products and applications using **onsemi** products, including compliance with all laws, regulations and safety requirements or standards, regardless of any support or applications information provided by **onsemi**. "Typical" parameters which may be provided in **onsemi** data sheets and/or specifications can and do vary in different applications and actual performance may vary over time. All operating parameters, including "Typicals" must be validated for each customer application by customer's technical experts. **onsemi** does not convey any license under any of its intellectual property rights nor the rights of others. **onsemi** products are not designed, intended, or authorized for use as a critical component in life support systems or any FDA Class 3 medical devices or medical devices with a same or similar classification in a foreign jurisdiction or any devices intended for implantation in the human body. Should Buyer purchase or use **onsemi** products for any such unintended or unauthorized application, Buyer shall indemnify and hold **onsemi** and its officers, employees, subsidiaries, affiliates, and distributors harmless against all claims, costs, damages, and expenses, and reasonable attorney fees arising out of, directly or indirectly, any claim of personal injury or death associated with such unintended or unauthorized use, even if such claim alleges that **onsemi** was negligent regarding the design or manufacture of the part. **onsemi** is an Equal Opportunity/Affirmative Action Employer. This literature is subject to all applicable copyright laws and is not for resale in any manner.

PUBLICATION ORDERING INFORMATION

LITERATURE FULFILLMENT:

Email Requests to: orderlit@onsemi.com

onsemi Website: www.onsemi.com

TECHNICAL SUPPORT

North American Technical Support:

Voice Mail: 1 800-282-9855 Toll Free USA/Canada

Phone: 011 421 33 790 2910

Europe, Middle East and Africa Technical Support:

Phone: 00421 33 790 2910

For additional information, please contact your local Sales Representative

Mouser Electronics

Authorized Distributor

Click to View Pricing, Inventory, Delivery & Lifecycle Information:

[onsemi:](#)

[NCV8406DTRKG](#) [NCV8406ASTT1G](#) [NCV8406ADTRKG](#) [NCV8406STT3G](#) [NCV8406ASTT3G](#) [NCV8406BDTRKG](#)